



Read this “User’s Guide”, and keep it handy for future reference.

## User’s Guide HITACHI SJ Series Inverter

P1



Mandatory

Necessary

Check

Ref

Introduction
Contents
Chapter 1 Safety Instructions/Risks
Chapter 2 Handling of This User’s Guide
Chapter 3 You Can Run the Inverter after Reading This Chapter
Chapter 4 Main Body of the Product
Chapter 5 Included Items
Chapter 6 Installation
Chapter 7 Wire Connection and Optional Devices
Chapter 8 Risk Check
Chapter 9 Operating
Chapter 10 Test Run
Chapter 11 Setting of Operated Command
Chapter 12 Inverter Functions
Chapter 13 Information Monitor Functions
Chapter 14 RS-485 Communication
Chapter 15 Option Cassette
Chapter 16 ProDriveNext / EzSQ
Chapter 17 Connection with PLC
Chapter 18 Tips/FAQ/Troubleshooting
Chapter 19 Maintenance and Inspection
Chapter 20 Specifications
Appendix List of Parameters

# 1

## Chapter 1 Safety Instructions/Risks



### Contents

- 1.1 What this Chapter Explains ..... 1-1
- 1.2 Types of Warnings ..... 1-1
- 1.3 Description of Safety Symbols..... 1-2
- 1.4 Cautions ..... 1-3
  - 1.4.1 Caution! ..... 1-3
  - 1.4.2 Precautions for installation ..... 1-4
  - 1.4.3 Precautions for Wiring ..... 1-5
  - 1.4.4 Precautions for Running and Test Running ..... 1-6
  - 1.4.5 Precautions for Maintenance/  
Daily Inspection ..... 1-7
  - 1.4.6 Precautions for disposal ..... 1-8
  - 1.4.7 Other Cautions ..... 1-9
- 1.5 Examples of Caution Labels ..... 1-10
- 1.6 Response to European Directive (CE)..... 1-11
  - 1.6.1 Caution for EMC  
(Electromagnetic Compatibility) ..... 1-11
  - 1.6.2 Caution for Machinery Directive  
(Functional Safety) ..... 1-13
- 1.7 Response to UL standards ..... 1-14

### 1.2 Types of Warnings

In the User’s Guide, the severity levels of safety precautions and residual risks are classified as follows: “DANGER”, “WARNING” and “CAUTION”.

Meanings of the Displays

 <b>DANGER</b>
<p>Indicates that incorrect handling may cause hazardous situations, which have a high chance of resulting in serious personal injury or death, and may result in major physical loss or damage.</p>
 <b>WARNING</b>
<p>Indicates that incorrect handling may cause hazardous situations, which may result in serious personal injury or death, and may result in major physical loss or damage.</p>
 <b>CAUTION</b>
<p>Indicates that incorrect handling may cause hazardous situations, which may result in moderate or slight personal injury or damage, and may result in physical loss or damage alone.</p>

Note that even a “ CAUTION” level situation may lead to serious danger according to circumstances. Be sure to follow every safety instruction, which contains important safety information.

The text includes notes using a safety symbol “”. Also be sure to pay attention to the meaning of this symbol to follow.

### 1.1 What This Chapter Explains







This chapter includes instructions for installation, wiring, operation, maintenance, inspection and use of the inverter.

Be sure to read this User’s Guide and appended documents thoroughly before installing, wiring, operating, maintaining, inspecting or using the inverter.

### 1.3 Description of Safety Symbols

The text includes notes using safety symbols.  
Also be sure to pay attention to the meaning of each symbol to follow.

#### Meanings of the Symbols

	Indicates a danger, warning or caution notice for fire, electric shock and high temperature in the operation of the product. Details are indicated in or near  by pictures or words.	
		The drawing on the left indicates "a non-specific and general danger or caution".
		The drawing on the left indicates "a possible damage due to electric shock".
	Indicates "what you must not do" to prohibit the described acts in the operation of the product.	
	Indicates "what you must do" according to the instructions in the operation of the product.	

## 1.4 Cautions

### 1.4.1 Caution!



- Incorrect handling may result in personal death or severe injury, or may result in damage to the inverter, motor or the whole system.



- Be sure to read the Guide and appended documents thoroughly before installing, wiring, operating, maintaining, inspecting or using the inverter.



- Notes for possible causes of danger or damage are also provided for each explanation in other sections.



- Be sure to read the corresponding explanation thoroughly before installing, wiring, operating, maintaining, inspecting or using the inverter.



- Many of the drawings in the Guide show the inverter with covers and/or parts blocking your view removed to illustrate the details of the product.



- Do not operate the inverter in the status shown in those drawings. If you have removed the covers and/or parts, be sure to reinstall them in their original positions before starting operation, and follow all instructions in this guide when operating the inverter.

## 1.4.2 Precautions for installation

**Warning**
**Fire**

- **Otherwise, you run the risk of fire.**

**Prohibited**

- Do not place flammable materials near the installed inverter.
- Prevent foreign matter (e.g., cut pieces of wire, sputtering welding materials, iron chips, wire, and dust) from entering the inverter.

**Do**

- Install the inverter on a non-flammable surface, e.g., metal.
- Install the inverter in a well-ventilated indoor site not exposed to direct sunlight. Avoid places where the inverter is exposed to high temperature, high humidity, condensation, dust, explosive gases, corrosive gases, flammable gases, grinding fluid mist, hydrogen sulfide or salt water.

**Injury**

- **Otherwise, you run the risk of injury.**

**Prohibited**

- Do not install and operate the inverter if it is damaged or parts are missing.

**Fall Injury**

- **Otherwise, you run the risk of injury due to the fall of an inverter.**

**Prohibited**

- - When carrying the inverter, do not hold its cover parts.

**Do**

- Install the inverter on a structure able to bear the weight specified in the User's Guide.
- Install the inverter on a vertical wall that is free of vibrations.

**Failure**

- **Otherwise, the inverter may fail.**

**Prohibited**

- The inverter is precision equipment. Do not allow it to fall or be subject to high impacts.
- Also do not step on it, or place a heavy load on it.
- Avoid places where static electricity discharges often occur (for example, on a rug) for the operation of the product.

**Do**

- In order to discharge static electricity from your body, touch a safe metal surface first before starting the operation.

## 1.4.3 Precautions for Wiring

**DANGER**

**Electric shock  
Fire**

**Do**

- **Otherwise, you run the risk of electric shock or fire.**
- Be sure to ground the inverter.
- Entrust wiring work to a qualified electrician.
- Before wiring, be sure to turn off the power supply and wait for 10 minutes or more. (Confirm that the Charge lamp on the inverter is off and the DC voltage between terminals P and N is 45 V or less.)



**Failure**

**Prohibited**

- **Otherwise, the inverter may fail.**
- Do not pull the wire after wiring.



**Electric shock  
Injury**

**Do**

- **Otherwise, you run the risk of electric shock and injury.**
- Perform wiring only after installing the inverter.



**Short circuit  
Ground fault**

**Prohibited**

- **Otherwise, you run the risk of short circuit and ground fault.**
- Do not remove rubber bushings from the wiring section. Otherwise, the edges of the wiring cover may damage the wire.

**Warning**

**Injury  
Fire**

**Prohibited****Do**

- **Otherwise, you run the risk of injury or fire.**
- Do not connect AC power supply to any of the output terminals (U, V, and W).
- Make sure that the voltage and frequency of AC power supply match the rated voltage (AC input voltage) and frequency of your inverter.



**Electric shock  
Injury**

**Do**

- **Otherwise, you run the risk of electric shock and injury.**
- Before operating the slide switch SW in the inverter, be sure to turn off the power supply.
- Since the inverter supports two modes of cooling-fan operation, the inverter power is not always off, even when the cooling fan is stopped. Before operating the switch, be sure to turn off the power supply and wait for 10 minutes or more. (Confirm that the Charge lamp on the inverter is off and the DC voltage between terminals P and N is 45 V or less.)
- Prevent the distribution cable from being compressed or getting caught to avoid damage to the cable.



**Fire**

**Prohibited****Do**

- **Otherwise, you run the risk of fire.**
- Do not use a single-phase input.
- Do not connect a resistor directly to any of the DC terminals (PD, P, and N).
- Do not use the magnetic contactor installed on the primary and secondary sides of the inverter to stop its operation.
- Tighten each screw and bolt to the specified torque.
- No screws and bolts must be left loose.
- Connect an earth-leakage breaker to the power input circuit.
- Use only the power cables, earth-leakage breaker, and magnetic contactors that have the specified capacity (ratings).



**Burnout**

**Prohibited**

- **Otherwise, you run the risk of damage to the inverter and motor burnout.**
- Do not operate the inverter when an output phase is lost (output phase loss).

## 1.4.4 Precautions for Running and Test Running

**DANGER****Electric shock  
Fire****Prohibited**

- **Otherwise, you run the risk of electric shock or fire.**
- While power is supplied to the inverter, do not touch any internal part or the terminal of the inverter. Also do not check signals, or connect or disconnect any wire or connector.
- While power is supplied to the inverter, do not touch any internal part of the inverter. Also do not insert a bar in it.

**Electric shock****Prohibited**

- **Otherwise, you run the risk of electric shock.**
- Be sure to close the terminal block cover before turning on the inverter power. Do not open the terminal block cover while power is being supplied to the inverter or voltage remains inside. Do not touch the internal PCB, terminal block or connector while power is being supplied to the inverter or voltage remains inside.
- Do not operate switches in the inverter or on the board with wet hands.

**Injury  
Fire****Prohibited**

- **Otherwise, you run the risk of injury or fire.**
- While power is supplied to the inverter, do not touch the terminal of the inverter, even if it has stopped.

**Injury  
Damage****Prohibited**

- **Otherwise, you run the risk of injury and damage to the machine.**
- Do not select the retry mode for controlling an elevating or traveling device because free-running status occurs in retry mode.
- If you use the EzSQ program, before operating the inverter, verify that secure operation of the program is ensured.

**Injury****Prohibited****Do**

- **Otherwise, you run the risk of injury.**
- If the retry mode has been selected, the inverter will restart suddenly after a break upon detection of an error. Stay away from the machine controlled by the inverter when the inverter is under such circumstances. (Design the machine so that human safety can be ensured, even when the inverter restarts suddenly.)
- - The [STOP] key on the operator keypad VOP can be enabled/disabled using the [AA-13] STOP key and is effective only when the normal communication is established with the main unit. Prepare an emergency stop switch separately.
- If an operation command has been input to the inverter before a short-term power failure, the inverter may restart operation after the power recovery. If such a restart may put persons in danger, design a system configuration that disables the inverter from restarting after power recovery.
- If an operation command has been input to the inverter before the inverter enters alarm status, the inverter will restart suddenly when the alarm status is reset (by terminal, key operation or communication). Before resetting the alarm status, make sure that no operation command has been input.
- When an unexpected event occurs, do not touch the inverter or cable.
- Make sure to understand and check the functions the inverter provides to confirm safety. Be careful that operation commands or resetting operation do not cause an unexpected restart.
- When an error (alarm) occurs, before moving to the next operation (resetting the alarm status or reapplying the power), make sure that no operation command has been input. If the inverter has received an operation command, it restarts automatically.

**Warning****Injury  
Damage****Do**

- **Otherwise, you run the risk of injury and damage to the machine.**
- The inverter allows you to easily control the speed of the motor or machine operations. Before operating the inverter, confirm the capacity and ratings of the motor or machine controlled by the inverter.
- When using the inverter to operate a motor at a high frequency, check the allowable motor speeds with the manufacturers of the motor and the machine to be driven and obtain their consent before starting inverter operation.
- During inverter operation, check the motor for the direction of rotation, abnormal sound, and vibrations.

**Burn  
injury****Prohibited**

- **Otherwise, you run the risk of burn injury.**
- Do not touch the heat sink, which heats up during the inverter operation.

**Injury****Do**

- **Otherwise, you run the risk of injury.**
- Install an external brake system if needed.

## 1.4.5 Precautions for Maintenance/Daily Inspection

**DANGER****Electric shock****Do**

- **Otherwise, you run the risk of electric shock.**

- Before inspecting the inverter, be sure to turn off the power supply and wait for 10 minutes or more. (Confirm that the Charge lamp on the inverter is off and the DC voltage between terminals P and N is 45 V or less.)

**Prohibited**

- Entrust only a designated person for maintenance, inspection, and the replacement of parts. (Be sure to remove wristwatches and metal accessories, e.g., bracelets, before maintenance and inspection work and to use insulated tools for the work.)



## 1.4.6 Precautions for disposal



Injury  
Explosion

- Otherwise, you run the risk of injury and explosion.



Do

- For disposal of the inverter, outsource the disposal to a qualified industrial waste disposal contractor. Disposing of the inverter on your own may result in an explosion of the capacitor or produce poisonous gas.
- Contact us or your distributor for fixing the inverter.



Do

- A qualified waste disposer includes “industrial waste collector/transporter” and “industrial waste disposal operator”. Follow the procedures stipulated in the “Waste Management and Public Cleansing Act” for disposing of the inverter.

## 1.4.7 Other Cautions

**DANGER**

Electric  
shock  
Fire  
Injury



Prohibited

- Otherwise, you run the risk of electric shock, fire and injury.
- Never modify the inverter.

\* For risks other than the above, also refer to "Chapter 8 Operation Check".

**Caution**

Life cycle



Do

- Otherwise, you run the risk of significantly shortening the life cycle of the product.
- If wood materials for packaging are needed to be sterilized and disinfected, make sure to use a means other than the wood fumigation method. If the product is included in the fumigation treatment, electronic parts could receive critical damage from the emitted gases or vapors. Especially, halogen disinfectants (including fluorine, chlorine, bromine and iodine) can cause corrosion in the capacitor.

1.5 Examples of Caution Labels

- The following describes label formats to prevent errors from occurring in the motor, inverter and system.
- If external operation, program operation or retry function has been set, the operation may start automatically after the power is off. Use these labels referring to the examples on the right as a reminder for caution.

(Examples of labels)

- Write instructions on these labels as a reminder.



(Examples of labels)

- Reminder for caution for retry operation after an error



(Examples of labels)

- Reminder for caution for remote operation in communication and terminal contact operation after the power is on.

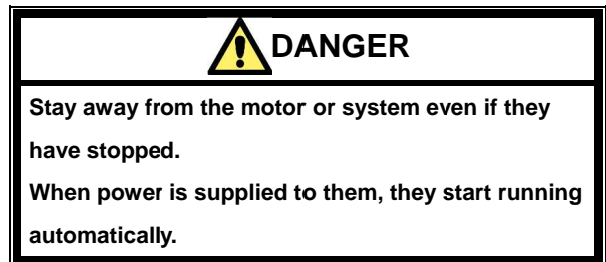

## 1.6 Response to European Directive (CE)

### 1.6.1 CAUTION for EMC (Electromagnetic Compatibility)

The SJ series P1 inverter conforms to requirements of the Electromagnetic Compatibility (EMC) Directive (2014/30/EU). However, when using the inverter in Europe, you must comply with the following specifications and requirements to meet the EMC Directive and other standards in Europe:



**WARNING:** This equipment must be installed, adjusted, and maintained by qualified engineers who have expert knowledge of electric work, inverter operation, and the hazardous circumstances that can occur. Otherwise, personal injury may result.

1. Power supply requirements
  - a. Voltage fluctuation must be -15% to +10% or less.
  - b. Voltage imbalance must be  $\pm 3\%$  or less.
  - c. Frequency variation must be  $\pm 4\%$  or less.
  - d. Total harmonic distortion (THD) of voltage must be  $\pm 10\%$  or less.
2. Installation requirement
  - a. SJ series P1 includes a built-in EMC filter. The built-in EMC filter must be activated.
3. Wiring requirements
  - a. A shielded wire (screened cable) must be used for motor wiring, and the length of the cable must be according to the following table (Table 1 on page 1-12).
  - b. The carrier frequency must be set according to the following table to meet an EMC requirement (Table 1 on page 1-12).
  - c. The main circuit wiring must be separated from the control circuit wiring.
4. Environmental requirements  
(to be met when a filter is used)
  - a. SJ series P1 inverter that is an activated built-in EMC filter must be according to SJ series P1 specifications.

Table 1

Model Model	Cat.	Cable length Cable length	Carrier frequency Carrier frequency	Model model	Cat.	Cable length Cable length	Carrier frequency Carrier frequency
P1-00044-L (P1-004L)	C3	10m	2kHz				
P1-00080-L (P1-007L)	C3	10m	2kHz	P1-00041-H (P1-007H)	C3	10m	2kHz
P1-00104-L (P1-015L)	C3	10m	2kHz	P1-00054-H (P1-015H)	C3	10m	2kHz
P1-00104-L (P1-015L)	C3	10m	2kHz	P1-00083-H (P1-022H)	C3	10m	2kHz
P1-00228-L (P1-037L)	C3	10m	2kHz	P1-00126-H (P1-037H)	C3	10m	2kHz
P1-00330-L (P1-055L)	C3	5m	2kHz	P1-00175-H (P1-055H)	C3	5m	2kHz
P1-00460-L (P1-075L)	C3	5m	2kHz	P1-00250-H (P1-075H)	C3	5m	2kHz
P1-00600-L (P1-110L)	C3	5m	2kHz	P1-00310-H (P1-110H)	C3	5m	2kHz
P1-00800-L (P1-150L)	C3	10m	1kHz	P1-00400-H (P1-150H)	C3	10m	2kHz
P1-00930-L (P1-185L)	C3	10m	1kHz	P1-00470-H (P1-185H)	C3	10m	2kHz
P1-01240-L (P1-220L)	C3	10m	1kHz	P1-00620-H (P1-220H)	C3	10m	2kHz
P1-01530-L (P1-300L)	C3	5m	2kHz	P1-00770-H (P1-300H)	C3	5m	2kHz
P1-01850-L (P1-370L)	C3	5m	2kHz	P1-00930-H (P1-370H)	C3	5m	2kHz
P1-02290-L (P1-450L)	C3	5m	2kHz	P1-01160-H (P1-450H)	C3	5m	2kHz
P1-02950-L (P1-550L)	C3	5m	2kHz	P1-01470-H (P1-550H)	C3	5m	2kHz
P1-03520-L (P1-750L)	C3	5m	2kHz	P1-01760-H (P1-750H)	C3	5m	2kHz
				P1-02130-H (P1-900H)	C3	5m	2kHz
				P1-02520-H (P1-1100H)	C3	5m	2kHz
				P1-03160-H (P1-1320H)	C3	5m	2kHz

### 1.6.2 Caution for Machinery Directive (Functional Safety)

- The SJ series inverter P1 will meet the requirements for functional safety.
- Functional Safety Guide SJ-P1 will be provided for handling for functional safety. (In preparation)

## 1.7 Response to UL standards

### **UL CAUTION**

#### GENERAL:

The SJ series Type P1 inverter is an open type AC Inverter with three phase input and three phase output. It is intended to be used in an enclosure. It is used to provide both an adjustable voltage and adjustable frequency to the ac motor. The inverter automatically maintains the required volts-Hz ratio allowing the capability through the motor speed range. It is a multi-rated device and the ratings are selectable according to load types by operator with key pad operation.

#### Markings:

##### Maximum Surrounding Temperature:

- ND (Normal Duty) : 50degC
- LD (Low Duty) : 45degC
- VLD (Very Low Duty): 40degC

##### Storage Environment rating:

- 65degC (for transportation)

##### Instruction for installation:

- pollution degree 2 environment and Overvoltage category III

##### Electrical Connections:

- See [7.5 Wiring to the main circuit terminal block] of the users guide.

##### Interconnection and wiring diagrams:

- See [7.7 Control circuit terminals] of the basic guide.

Field wiring terminal conductor size and Torque Values making for field wiring terminal:

Model Model	Load Type Load Type	Required Torque (N.m) Required Torque	Conductor size (AWG) Conductor size	Model Model	Load Type Load Type	Required Torque (N.m) Required Torque	Conductor size (AWG) Conductor size
P1-00044-L (P1-004L)	VLD	1.4	14				
	LD						
	ND						
P1-00080-L (P1-007L)	VLD	1.4	14	P1-00041-H (P1-007H)	VLD	1.4	14
	LD						
	ND						
P1-00104-L (P1-015L)	VLD	1.4	14	P1-00054-H (P1-015H)	VLD	1.4	14
	LD						
	ND						
P1-00156-L (P1-022L)	VLD	1.4	10	P1-00083-H (P1-022H)	VLD	1.4	14
	LD						
	ND						
P1-00228-L (P1-037L)	VLD	1.4	10	P1-00126-H (P1-037H)	VLD	1.4	12
	LD				14		
	ND						
P1-00330-L (P1-055L)	VLD	3	8	P1-00175-H (P1-055H)	VLD	3	10
	LD				12		
	ND						
P1-00460-L (P1-075L)	VLD	3	6	P1-00250-H (P1-075H)	VLD	3	8
	LD		8		10		
	ND						
P1-00600-L (P1-110L)	VLD	4	4	P1-00310-H (P1-110H)	VLD	4	8
	LD						
	ND		6				
P1-00800-L (P1-150L)	VLD	2.5 –3.0	3	P1-00400-H (P1-150H)	VLD	4	8
	LD		4				
	ND						
P1-00930-L (P1-185L)	VLD	2.5 –3.0	1	P1-00470-H (P1-185H)	VLD	4	6
	LD		2		8		
	ND		3				
P1-01240-L (P1-220L)	VLD	5.5 –6.6	2/0	P1-00620-H (P1-220H)	VLD	4	4
	LD		1/0		6		
	ND		1				
P1-01530-L (P1-300L)	VLD	6.0	Parallel of 1/0	P1-00770-H (P1-300H)	VLD	6.0	1
	LD				2		
	ND				3		
P1-01850-L (P1-370L)	VLD	15.0	Parallel of 1/0	P1-00930-H (P1-370H)	VLD	15.0	1
	LD		Parallel of 1/0				
	ND		4/0				
P1-02290-L (P1-450L)	VLD	6.0 - 10.0	Parallel of 2/0	P1-01160-H (P1-450H)	VLD	6.0 - 10.0	Parallel of 2/0
	LD		Parallel of 1/0		Parallel of 1/0		
	ND		Parallel of 1/0		1		
P1-02950-L (P1-550L)	VLD	19.6	Parallel of 3/0	P1-01470-H (P1-550H)	VLD	6.0 - 10.0	Parallel of 1/0
	LD		Parallel of 3/0		Parallel of 1/0		
	ND		350kcmil		2/0		

- The temperature rating of field wiring installed conductors is only 75degC.
- Use Copper conductors only.



Required protection by Fuse and circuit-breakers:  
P1-L series models

Model Model	Fuse			Circuit Breaker	
	Type Type	Maximum Rating		Maximum Rating	
		Voltage (V)	Current (A)	Voltage (V)	Current (A)
P1-00044-L (P1-004L)	Class J or T	600	50	-	-
P1-00080-L (P1-007L)	Class J or T	600	50	-	-
P1-00104-L (P1-015L)	Class J or T	600	50	-	-
P1-00156-L (P1-022L)	Class J or T	600	50	-	-
P1-00228-L (P1-037L)	Class J or T	600	50	-	-
P1-00330-L (P1-055L)	Class J or T	600	100	-	-
P1-00460-L (P1-075L)	Class J or T	600	150	-	-
P1-00600-L (P1-110L)	Class J or T	600	150	-	-
P1-00800-L (P1-150L)	Class J or T	600	150	-	-
P1-00930-L (P1-185L)	Class J or T	600	200	-	-
P1-01240-L (P1-220L)	Class J or T	600	200	-	-
P1-01530-L (P1-300L)	Class J or T	600	300	-	-
P1-01850-L (P1-370L)	Class J or T	600	300	-	-
P1-02290-L (P1-450L)	Class J or T	600	300	-	-
P1-02950-L (P1-550L)	Class J or T	600	350	-	-

## P1-H series models

Model Model	Fuse			Circuit Breaker	
	Type Type	Maximum Rating		Maximum Rating	
		Voltage (V)	Current (A)	Voltage (V)	Current (A)
P1-00041-H (P1-007H)	Class J or T	600	30	-	-
P1-00054-H (P1-015H)	Class J or T	600	30	-	-
P1-00083-H (P1-022H)	Class J or T	600	30	-	-
P1-00126-H (P1-037H)	Class J or T	600	30	-	-
P1-00175-H (P1-055H)	Class J or T	600	75	-	-
P1-00250-H (P1-075H)	Class J or T	600	75	-	-
P1-00310-H (P1-110H)	Class J or T	600	75	-	-
P1-00400-H (P1-150H)	Class J or T	600	100	-	-
P1-00470-H (P1-185H)	Class J or T	600	100	-	-
P1-00620-H (P1-220H)	Class J or T	600	100	-	-
P1-00770-H (P1-300H)	Class J or T	600	200	-	-
P1-00930-H (P1-370H)	Class J or T	600	200	-	-
P1-01160-H (P1-450H)	Class J or T	600	200	-	-
P1-01470-H (P1-550H)	Class J or T	600	250	-	-

Short circuit rating and overcurrent protection device rating:

P1-L series models

- Suitable for use on a circuit capable of delivering not more than 5,000 rms symmetrical amperes, 240 V maximum.

P1-H series models

- Suitable for use on a circuit capable of delivering not more than 5,000 rms symmetrical amperes, 500 V maximum.

Integral:

- Integral solid state short circuit protection does not provide branch circuit protection. Branch circuit protection must be provided in accordance with the National Electrical Code and any additional local codes

## 2

## Chapter 2 Handling of This User's Guide

### Contents

2.1 What This Chapter Explains .....	2-1
2.2 Applicable Products .....	2-1
2.3 Before Reading The Guide .....	2-1
2.4 Purpose of the Guide.....	2-1
2.5 Overview of the Guide .....	2-2
2.6 Glossary .....	2-3
2.7. Operating Principles .....	2-5
2.7.1 Purpose of industrial motor control.....	2-5
2.7.2 What is an inverter?.....	2-5
2.8 Meanings of the Explanatory Symbols .....	2-6

### 2.1 What This Chapter Explains

This chapter includes explanations of applicable products, knowledge required for reading the Guide, those who should read the Guide, and the purpose, overview and glossary of the Guide.

### 2.2 Applicable Products

The contents of this guide are applicable to the SJ series inverter type P1. Refer to the corresponding instruction manuals for other products and optional parts.

### 2.3 Before Reading the Guide

The Guide is meant to be read by those who have knowledge of electricity (certified electrician or equivalent) and those who are in charge of introduction, installation or connection of control equipment, system design and workplace management.  
The Guide is written in SI units.

### 2.4 Purpose of the Guide

The Guide is meant to provide necessary information for the following:

- Installation and wiring of the product;
- Parameter settings;
- Running and test running; and
- Maintenance and inspection

## 2.5 Overview of the Guide

The Guide consists of the following chapters:

- **Safety Instructions/Risks (Chapter 1)** includes safety instructions for installation, wiring, operation, maintenance and inspection the inverter.
- **Handling of this User's Guide (Chapter 2)** includes explanations of those who should read the Guide and purpose of the Guide.
- **You Can Run the Inverter after Reading This Chapter (Chapter 3)** explains the overall process flow from installation to operation and provides a flow chart for driving motors.
- **Main Body of the Product (Chapter 4)** explains description on specification label on the main body and product's model and overview.
- **Included Items (Chapter 5)** explains items included in a product package.
- **Installation (Chapter 6)** provides notes for installation and installation environment of the inverter.
- **Wire Connection and Optional Devices (Chapter 7)** explains how to wire the inverter and connect separately-placed optional devices. See Chapter 15 for the optional cassette for installing inside the inverter.
- **Operation Check/Residual risks (Chapter 8)** provides an operation checklist for installation of the inverter.
- **Operating Instructions (Chapter 9)** explains how to operate the operator keypad equipped on the main body.
- **Test Runs (Chapter 10)** provides a flowchart to check for rotating the motor and operations required for test runs.
- **Examples of Settings by Operation Command Destination (Chapter 11)** explains how to connect I/O by input of operation commands and frequency commands.
- **Inverter Functions (Chapter 12)** explains functions available with the inverter.
- **Information Monitoring Functions (Chapter 13)** explains functions monitorable with the operator keypad.
- **RS485 Communication (Chapter 14)** explains communication functions using RS485 communication.
- **Wire Connection and Optional (Chapter 15)** includes explanations of optional cassettes installable in the SJ series inverter type P1.
- **ProDriveNext (PC software)/EzSQ (Chapter 16)** explains the availability of the SJ series inverter type P1 with PC connected.
- **Connection to PLC (Chapter 17)** explains how to connect to PLC.
- **Tips/FAQ/Troubleshooting (Chapter 18)** includes explanations of the error (trip) status of the inverter and provides troubleshooting information.
- **Maintenance and inspection (Chapter 19)** explains how to maintain and inspect the inverter.
- **Specifications (Chapter 20)** provides the specifications of the product.
- **Technical Notes (Chapter 21)** provides supplemental technical information.
- **List of Parameters and Index (Appendix)** provides explanations of the parameters for the SJ series inverter type P1. An index is provided at the end of the Guide.

## 2.6 Glossary

\*Kana syllabary order

A

Name	Description
Intelligent (relay) output terminal	Multi-functional contact output terminal. Multiple functions are available according to settings.
Intelligent input terminal	Multi-functional contact input terminal. Multiple functions are available according to settings.
Inverter model	The model indicated on the specification label of the inverter.

KA

Name	Description
Regenerating	Returning of power generated in the motor to the inverter when fans are rotated by wind or the motor speed is decreased.
Regenerative converter	An optional element to return regenerated power to the power supply. Significantly reduce harmonic current.
Regenerative braking unit	Consume regenerated power with a separately-placed braking resistor.
Optional cassette	A cassette-type optional part to be loaded in the slot on the front side of the product.
Open phase	A part of the power line is down, leading to unstable input/output.

\*Note concerning trademarks

Proper names such as the product name and function names mentioned in the Guide may be used by each company as its trademark or registered trademark. In this guide, no ® and ™ symbols are used.

SA

Name	Description
Main circuit power supply	Power supply required for running the inverter.
Potentiometer	A regulating device with a variable resistor. Connect to the analog input terminal.
Specification label	A label on the side the product, on which the specifications of the inverter are indicated.
Sink logic	Logic to turn a signal on by a current that flows out of the signal input terminal. This varies depending on systems.
Power supply for control circuit	Power supply required for settings using the operator keypad. Control circuit is supplied with power via R0 and T0 or P+ and P-.
Braking resistor	A power consuming resistor connected to a regenerative unit.
Operator keypad	A control panel on the front side to operate the inverter.
Source logic	Logic to turn a signal on by a current that flows into the signal input terminal. This varies depending on regions or systems.

TA

Name	Description
Charge lamp	Indicate the status of power input to the main circuit of the inverter. Power remains when the lamp is lit even after the power is off.

HA

Name	Description
Basic Guide	Basic instruction manual including only information required for handling the inverter.

YA

Name	Description
User's Guide	Instruction manual including detailed information required for handling the inverter.

\*Alphabetical order

C

Name	Description
CE logo	A logo used on the product that meets the requirements of the applicable EC directives. This is required for products sold within the European Economic Area.

E

Name	Description
EMC	Electromagnetic compatibility Properties that neither cause errors in other equipment nor cause errors due to noise.

I

Name	Description
IGBT	Insulated gate bipolar transistor One of switching devices of the inverter.
IM	Induction motor
I/O	Input/Output

L

Name	Description
LAD	Lead to acceleration and deceleration. Accelerate or decelerate the motor.
LD rated	Low duty: A type of load rating that indicates overload capacity. This can drive a higher current motor than ND but has a relatively lower overload capacity. This can be used for low load capacity.

M

Name	Description
MFG No.	Manufacturing No.

N

Name	Description
ND rated	Normal Duty: A type of load rating that indicates overload capacity. Generally this is used in severe load conditions.

P

Name	Description
PLC	Programmable logic controller
PMM	Permanent magnet synchronous motor PM motor. PM stands for permanent magnet.
PWM	Pulse Width Modulation Pulse output method of the inverter.

R

Name	Description
RTU	Remote terminal unit. The Modbus protocol name here.

S

Name	Description
SM	Synchronous motor. PMM is a type of SM.

U

Name	Description
UL standards	Standards issued by Underwriters Laboratories (Board of Fire Underwriters).

V

Name	Description
VLD rated	Very low duty: A type of load rating that indicates overload capacity. This can drive a higher current motor than LD but has a relatively lower overload capacity. This can be used for lower load capacity than LD.

## 2.7. Operating Principles

### A

- This section describes operating principles briefly.

#### 2.7.1 Purpose of industrial motor control

- A Hitachi inverter can vary three phase motor speed. Varying speed can provide advantages in many applications. For example, it is useful for the purposes on the right.

- Energy savings  
Ex.) HVAC (air-conditioner); fans; pumps

- Adjacent processes requiring speed adjustment  
Ex.) textile machines; printing machines

- Load requiring torque  
Ex.) machine tools; processing machines; transportation equipment

- Load requiring fine control  
Ex.) elevators; food processing; medical devices

#### 2.7.2 What is an inverter?

- An inverter can control the rotation speed and power consumption of motors by changing the frequency and voltage input to motors.
- Motors waste energy running fans and pumps using a commercial power supply and controlling the flow rate using valves and dampers. An inverter can lower the commercial power supply frequency and voltage, which contributes to energy savings by powering down without valves and dampers.
- An inverter is a device that converts direct current into alternating current. The diagram below illustrates the basic configuration of a general inverter.
- First the converter part converts alternating current supplied from the power supply into direct current through the rectifier circuit.
- The inverter part outputs frequency and voltage flexibly by outputting the direct current "chopped" by switching devices to the motor (PWM output).
- The volume of the sound and noise generated by the motor varies depending on the rate of chopping DC voltage of switching devices (carrier frequency) in the inverter part.

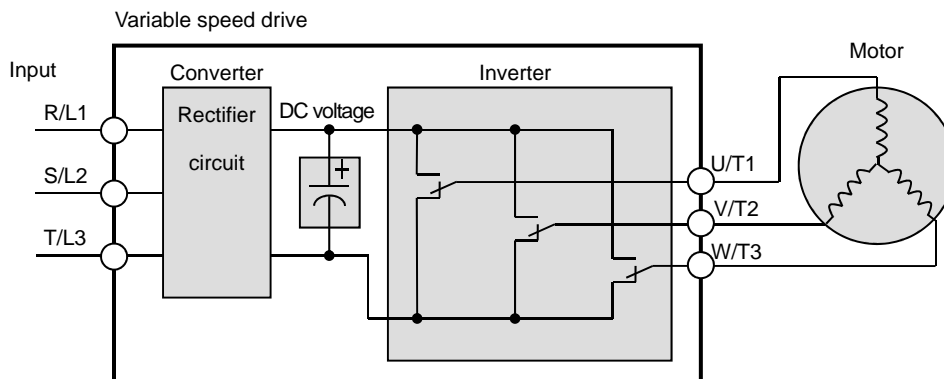







## 2.8 Meanings of the Explanatory Symbols

The following symbols are used for description in each section.

The meanings of the symbols are as follows.

Symbol and meanings	Description
General and troubleshooting questions 	Provide troubleshooting tips. When a similar problem occurs, using the inverter functions may solve the problem.
Key points for a solution 	Provide tips for settings for using functions and describe the details of functions.
Notes 	Provide notes for operating functions. The notes for operating functions include: Data is overwritten, No operation with no settings etc.
Confirmation of procedures 	Provide procedures for setting and adjusting the functions.

## 3

## Chapter 3 You Can Run the Inverter after Reading This Chapter

### Contents

3.1 What This Chapter Explains .....	3-1
3.2 Flow for Preparation of Operation .....	3-2
3.2.1 Check the Inverter .....	3-2
3.2.2 Install the Inverter .....	3-2
3.2.3 Wire the Inverter to Check the Power Supply ....	3-3
3.2.4 Operate the Operator Keypad .....	3-3
3.2.5 Prepare for Rotating the Motor .....	3-4
3.2.6 Troubleshooting .....	3-4

### 3.1 What This Chapter Explains

This chapter provides an operational process (flow) to do a test run.

For installation, wiring and settings for operation and detailed information of inverter functions, see the corresponding sections. Make sure to carefully read "Chapter 1 Safety Instructions/Risks" and corresponding sections for safety work.

3.2 Flow for Preparation of Operation

3.2.1 Check the Inverter

Check the contents in the package, and also check the model of your inverter on the specification label.

See “Chapter 4 Main Body of the Product” and “Chapter 5 Included Items” for details.

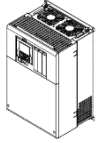

Inverter body

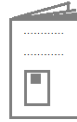

Basic Guide

Included items that vary depending on models (enclosed in the package)

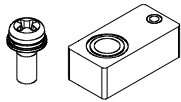

Available only for P1-01240-L(P1-220L)



Eye bolts for hanging the inverter  
P1-01850-L(P1-370L) - P1-02290-L(P1-550L)  
P1-00930H(P1-370H) - P1-01470-L(P1-550H)

3.2.2 Install the Inverter

Install the inverter. Leave sufficient space around the inverter for enough ventilation.

See “Chapter 6 Installation” for details.

For P1-00044-L-P1-01240-L (P1-004L-P1-220L);  
P1-00041-H-P1-00620-H (P1-007H-P1-220H)

For P1-01530-L-P1-02950-L (P1-300L-P1-550L);  
P1-00770-H-P1-01470-H (P1-300H-P1-550H)

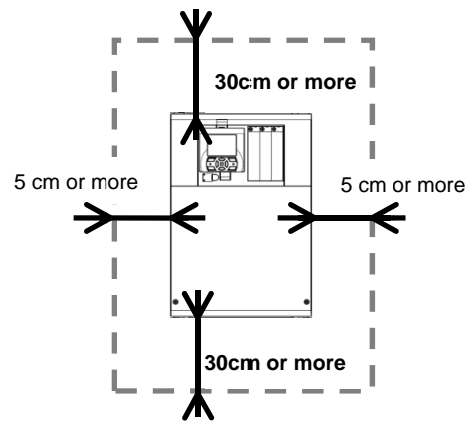
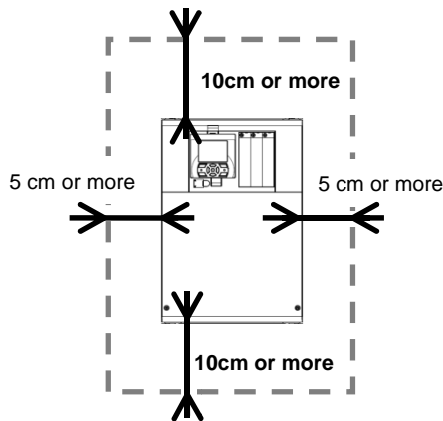

\* A clearance of 22 cm or more is required below the inverter to replace aged parts for the following models:

- P1-00800-L(P1-150L) - P1-01240-L(P1-220L)
- P1-00380-H(P1-150H) - P1-00620-H(P1-220H)

\* The inverter needs to be removed to replace aged parts for the following models:

- P1-00330-L(P1-055L) - P1-00600-L(P1-110L)
- P1-00175-H(P1-055H) - P1-00310-H(P1-110H)

**3.2.3 Wire the Inverter to Check the Power Supply**

- Wire the main circuit of the inverter.
- Before supplying the power, make sure to carefully read the safety instructions and be aware of your safety. The following illustration shows the power supply and wiring connections to a motor only.
- Follow the following steps to prevent miswiring.

- (1) Check the position of the charge lamp and make sure that the lamp is turned off.
- (2) Connect the inverter to the ground (G) and power supply line (R,S,T), and close the front cover.
- (3) Turn on the power and confirm that the POWER lamp on the operator keypad VOP is lit.

See “Chapter 1 Safety Instructions”, “Chapter 7 Wire Connection and Optional Devices” and “Chapter 11 Examples of Settings by Operation Command Destination” for details.

\*Allocation of terminals varies depending on models.  
\*This example shows a state with a J51 connector connected.

- (4) Turn off the power.
- (5) Make sure that the charge lamp is off and that the voltage between P and N is 45Vdc or less.
- (6) Connect the inverter to the motor line (U,V,W), and close the front cover.
- (3) Turn on the power to operate the operator keypad.

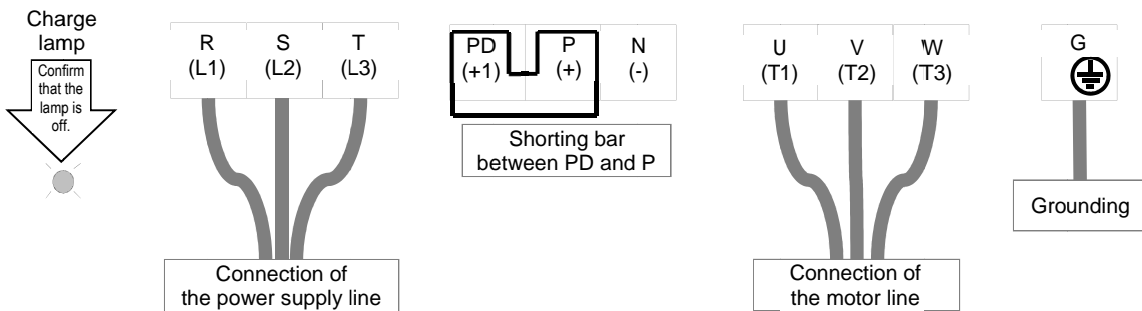

**3.2.4 Operate the Operator Keypad**

Confirm how to operate the operator keypad.

See “Chapter 9 Operating Instructions” for details.

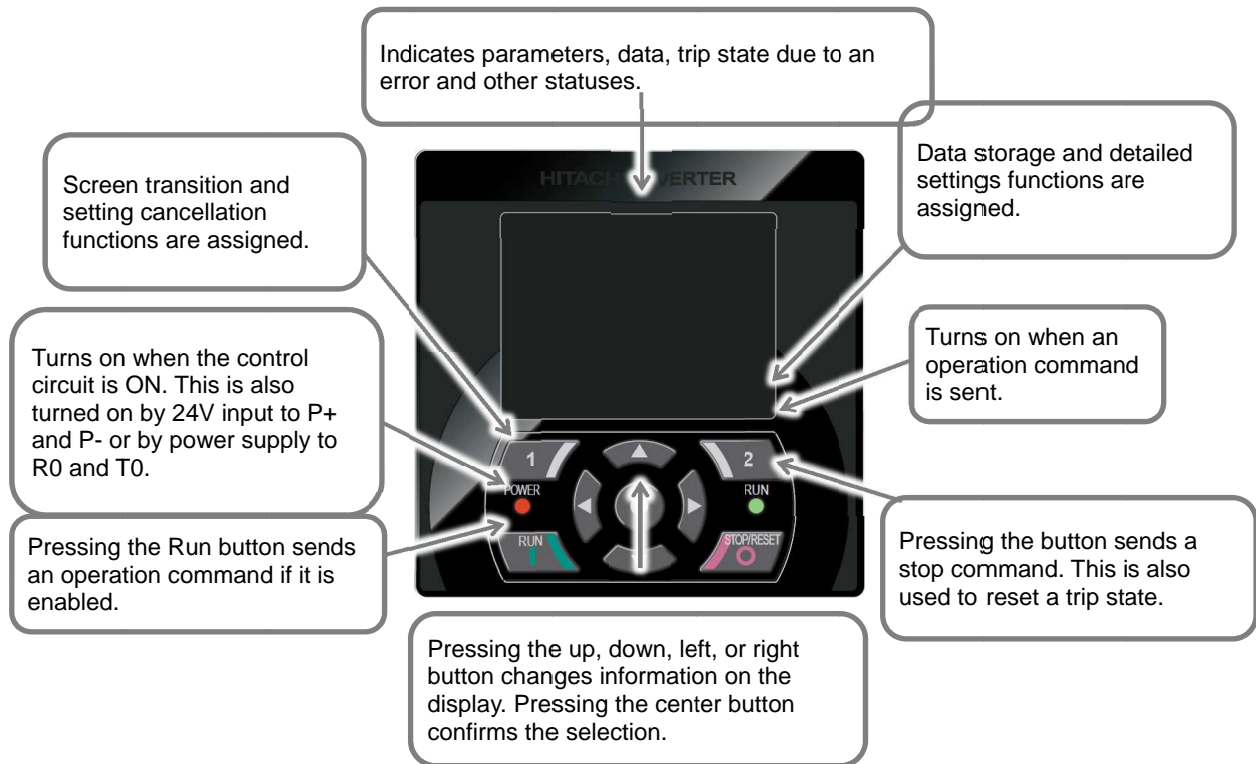

**3.2.5 Prepare for Rotating the Motor**

Only operating procedures using the operator keypad are shown here.  
Refer to “Chapter 10 Test Runs” for details.

Make sure that the **NRDY** indicator is not displayed.

Confirm that the FW or RV indicator is displayed.  
⇒ [AA111]=02

Press the right key to move forward a screen while pressing the O key to confirm the setting.  
Ex. Change [FA-01].

Confirm that a command is sent out from the operator keypad. ⇒ [AA101]=07

Confirm that the command frequency is at the desired value.  
⇒ (Ex.) [FA-01]=60.00Hz

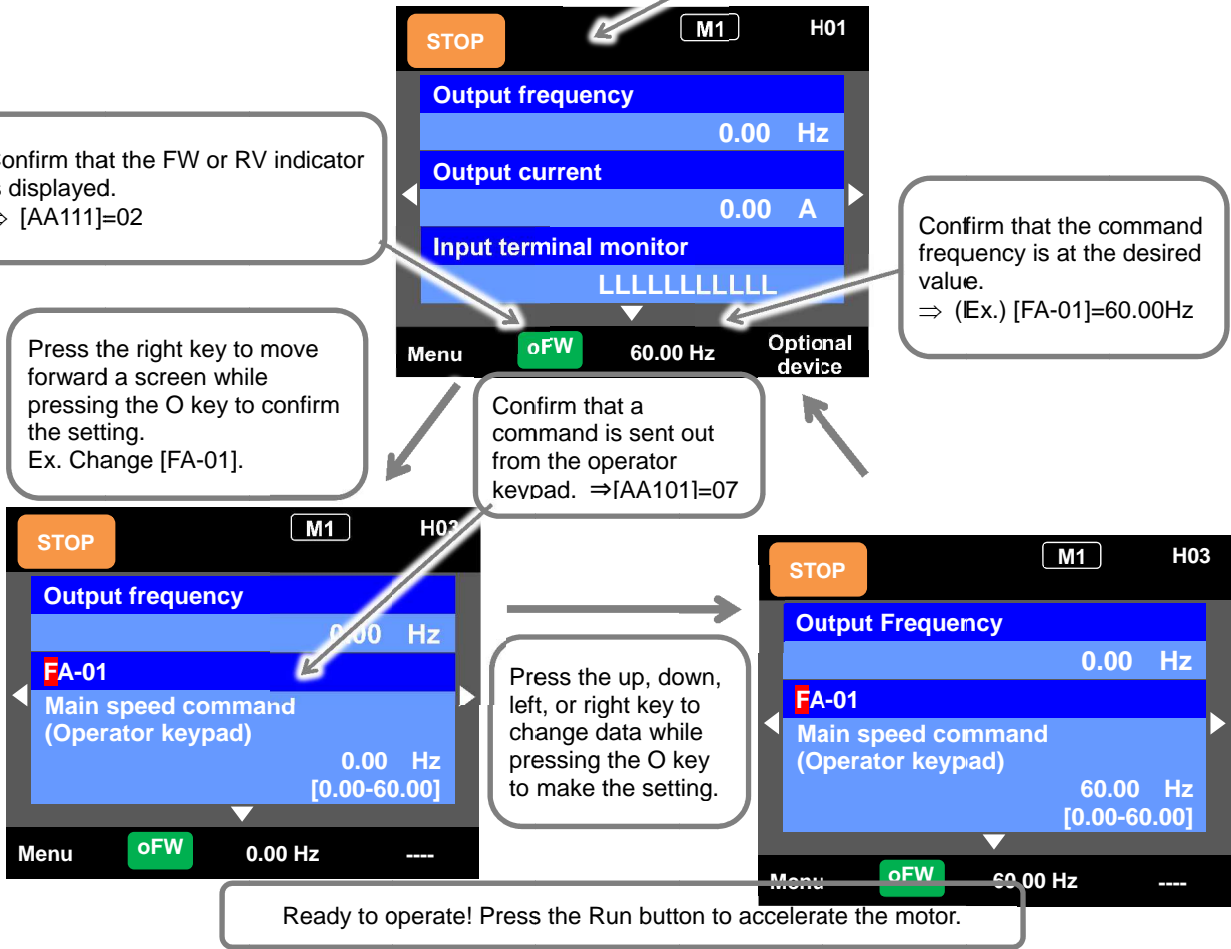

Ready to operate! Press the Run button to accelerate the motor.

**3.2.6 Troubleshooting**

**The motor does not rotate!**  
**An error indication appears on the inverter.**  
See “Chapter 18 Tips/FAQ/Troubleshooting”.

**How to operate the operator keypad.**  
See “Chapter 9 Operating Instructions”.

**How to reduce noise, suppress harmonics and increase regenerative potential.**  
See “Chapter 7 Wire Connection and Optional Devices”.

**How to run our inverter using external signals.**  
See “Chapter 10 Test Runs” and “Chapter 11 Examples of Settings by Operation Command Destination”.

**How to run our inverter with communications.**  
See “Chapter 14 RS485 Communication”.

**How to use the inverter functions.**  
**How to monitor the operating status.**  
See “Chapter 12 Inverter Functions” and “Chapter 13 Information Monitoring Functions”.

## 4





## Chapter 4 Main Body of the Product

### Contents

4.1 What This Chapter Explains .....	4-1
4.2 External Appearance of the Product .....	4-2
4.3 Model of the Product and Specification Label .....	4-3
4.3.1 Model of the Product .....	4-3
4.3.2 Specification Label .....	4-3
4.3.3 Indication for Japan .....	4-4
4.4 Method of Inquiry and Product Warranty .....	4-5
4.4.1 Method of Inquiry about Product .....	4-5
4.4.2 Product Warranty and Inquiry .....	4-5
4.4.3 Limitation of Liability .....	4-6
4.4.4 How to use our Warranty Service .....	4-6
4.4.5 Changes in Product Specification .....	4-6
4.4.6 Notes for Applying the Product .....	4-6
4.4.7 Supplement .....	4-6

### 4.1 What This Chapter Explains

The chapter provides explanations of the main body of the product. The explanations include: the external appearance and model of the product, what's written on the specification label and inspection instruction upon purchase.

Symbol	Meanings
	General and troubleshooting questions
	Key points for a solution
	Notes
	Confirmation of procedures

4.2 External Appearance of the Product



- How to check the external appearance.



- The cover is attached at factory shipment.

**Operator keypad**  
A removable liquid crystal panel (VOP).  
The POWER and RUN lamps are on it.

\* An example of P1-00330-LFF (P1-055LFF)

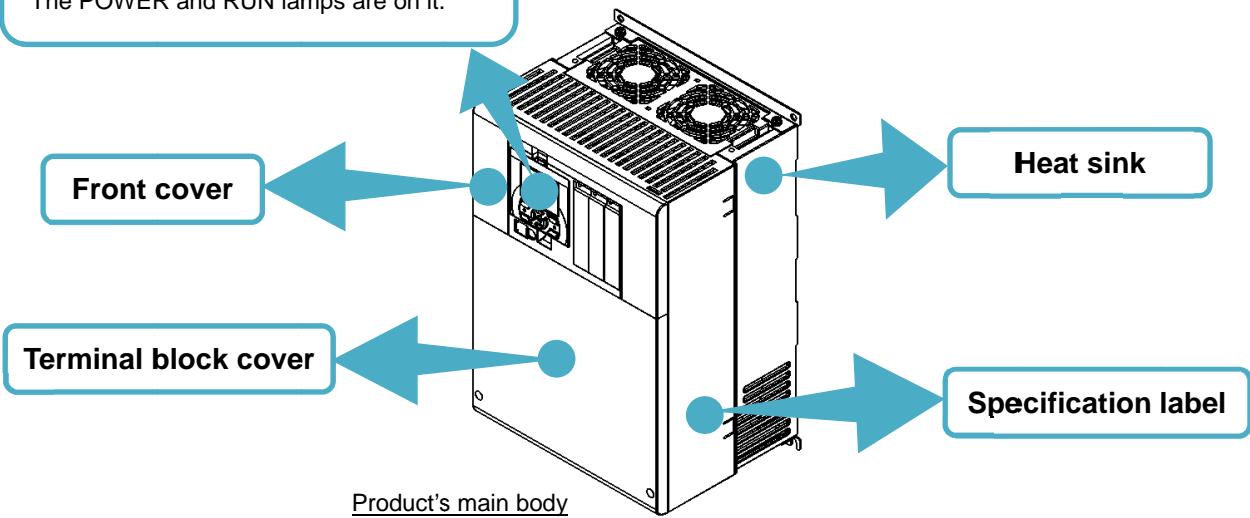

**Optional cassette installed**  
A maximum of three optional cassettes can be installed. (In preparation)

**Control circuit terminal block**  
Sends a command to the inverter and issues an alarm. Internal data can be imported into the external device through Ao or FM output terminal.

**Main circuit terminal block**  
Connects the power supply and motor. This is also used for connecting optional devices including reactor.

**Backing plate**

Product's main body  
(with a front cover opened)

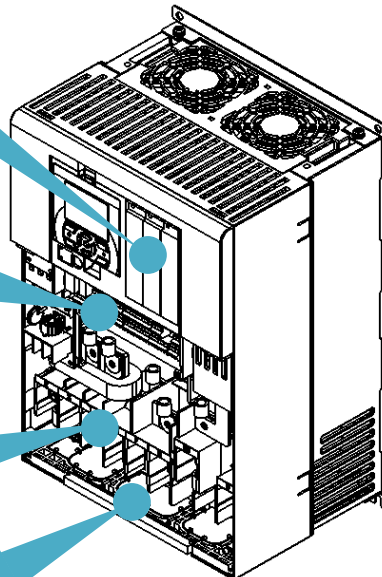

### 4.3 Model of the Product and Specification Label

#### 4.3.1 Model of the Product



- How to read a model number.



- The model of the product is as follows:

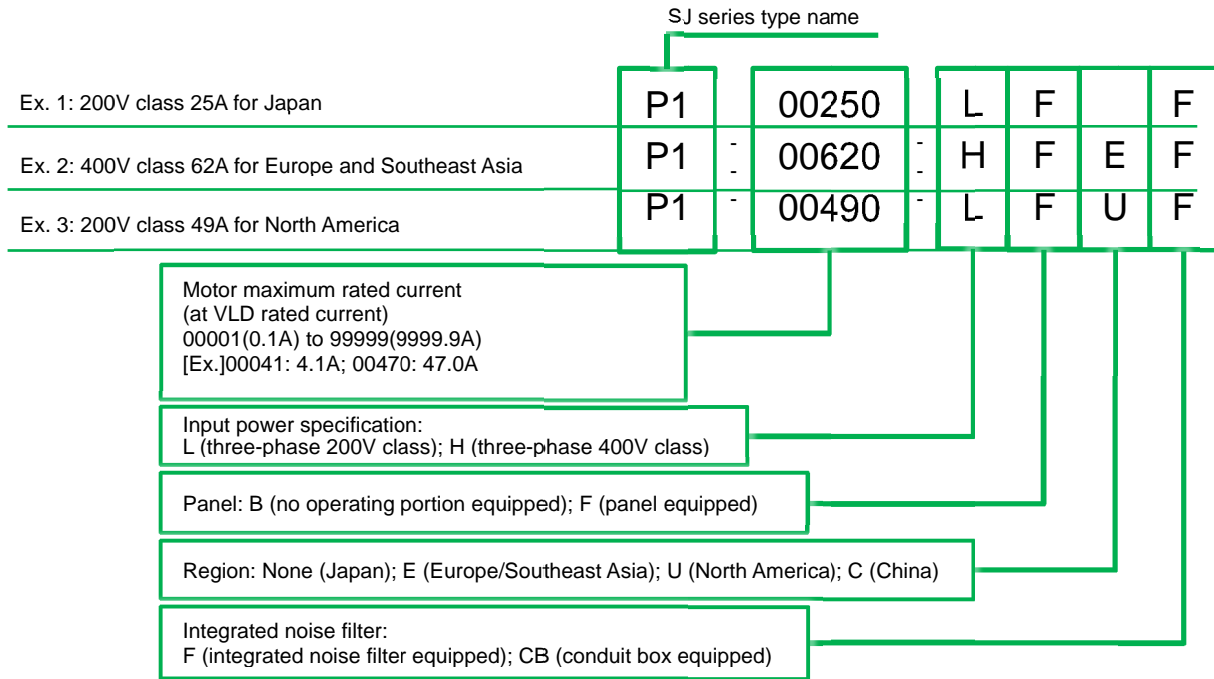

#### 4.3.2 Specification Label



- What's written on the specifications label?  
Example of a specification label:  
P1-00330-LFF(P1-055LFF) for Japan



- The model of the product is indicated on the specification label on the side of the product. The details on the specification label are as follows:

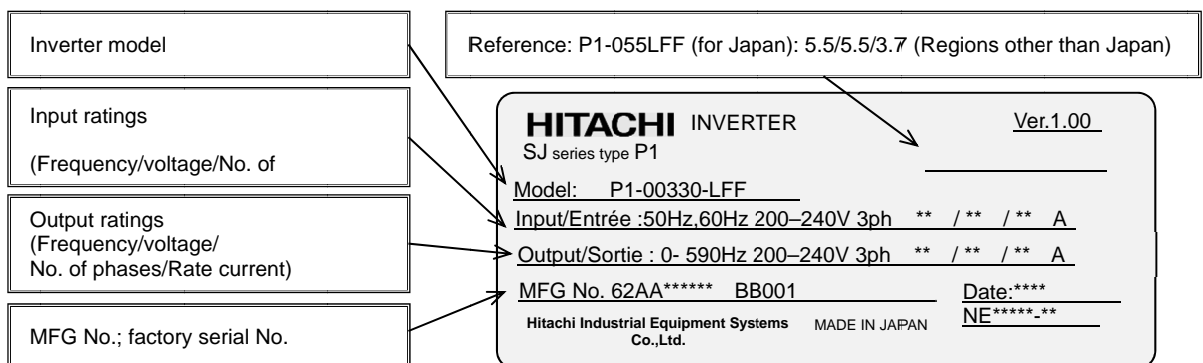

- In this Guide, some indications after input power specification may be omitted in the model name, in this case, however, the specifications provided are not concerned with the omitted indications.

- The input current value on the specification label is the value that complies with UL Standards.
- (\*) shows the product-specific values.



4.3.3 Indication for Japan

Indication example: P1-00330-LFF(P1-055LFF) for Japan

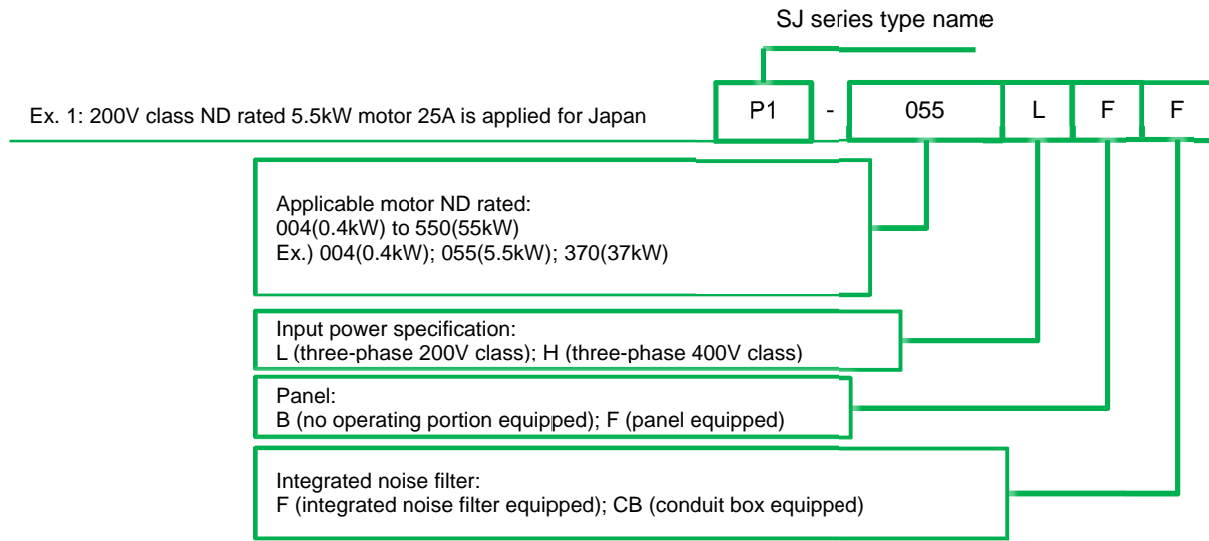

See “Chapter 20 Specifications” for the corresponding models.

## 4.4 Method of Inquiry and Product Warranty

### 4.4.1 Method of Inquiry about Product

**A**

- For an inquiry about product damage or faults or a question about the product, notify your supplier or the Technical Inquiry Service for Inverter on the back cover of the information shown on the right side.

- Inverter Model: A model name beginning with P1- described on the specification label.
- MFG No.: Indicated on the specification label.
- Date of purchase: Your date of purchase
- Content of inquiry
  - Event occurred and its condition
  - Content of your question

### 4.4.2 Product Warranty and Inquiry

**A**

- Hitachi Industrial Equipment Systems (*our company*) warrants that SJ series inverter type P1 you purchase is free from defects in manufacturing under normal use during the warranty period.
- The warranty will only apply to damages to the delivered inverter and excludes all damage to other equipment and systems induced by any fault of the inverter, or the use of the motor, machines or power supply in an inappropriate installation environment exceeding the specified values or with inadequate parameters. You are requested to minimize risks to other equipment and systems induced by any fault or failure of the delivered inverter, and to ensure safety design and measures that can inform the user of the risks. For the use of the delivered inverter, maintain the safety margin in rating and performance while make a design of other equipment and systems with enough margin and redundancy. Our company does not guarantee the applicability of the delivered inverter to your purpose, so be sure to check on your own in advance.
- If defects in manufacturing are found in a purchased product, our company will, at our company's discretion, repair or replace the product in question free of charge, provided the product is still under warranty (*Warranty Service*).
- The warranty period is for one year from your date of purchase. If any on-site repair service is required in Japan or other countries, you are asked to pay the actual expenses incurred for dispatching technical personnel depending on circumstances. In addition, our company has no responsibility for on-site readjustment or test runs due to a failure.
- The warranty period for the parts repaired or replaced in terms of the Warranty Service is for six months after completion of repair of the repaired or replaced parts. If any defect occurs to the repaired or replaced parts during the above period, our company will have responsibility for repairing or replacing the parts again.
- For receiving the Warranty Service, prepare a document stating your date of purchase such as the receipt issued where you purchased the product. Note that our Warranty Service does not cover failure, damage, malfunction, or any other defect in our products resulting from any one of the following:
  - (1) Your date of purchase is not verified;
  - (2) Losses or damages caused by inadequate use without following the conditions of use, handling instructions and notes as stated in the User's Guide of the product;
  - (3) Inappropriate use, manipulation, or improper repair of the product or repair by anyone other than our authorized repair technicians;
  - (4) Deterioration and wearing out of the product resulting from normal use;
  - (5) Damage due to earthquakes, fires, lightning strikes or other acts of nature, environmental or salt pollution, along with abnormal voltages and any other external factors;
  - (6) Falls or impacts that occur during transportation or travel after purchase;
  - (7) Losses or damages caused by software programmed by anyone other than our company's personnel;
  - (8) Losses or damages caused by software you installed; or
  - (9) Use in any countries other than Japan
- Your data or programs stored in the memory of the product may be lost during repair. Store a backup of your data and programs in advance on your own responsibility.

### 4.4.3 Limitation of Liability

- This warranty specifies all the warranties provided to you, and our company, our affiliates and sales outlets disclaim responsibility for any or all express or implied warranty of the product including any warranty of merchantability or fitness for specific purposes.
- In no event shall our company, our affiliates and sales outlets be responsible for any accidental, special, direct, or indirect damages sustained by you resulting from poor quality of the product (regardless of predictability).

### 4.4.4 How to use our Warranty Service

- If our product fails to function as stated in the Guide or Basic Guide during the warranty period, you can receive our Warranty Service by contacting your supplier or local Hitachi Distributor. If future updates create any discrepancy between the Guide and Basic Guide, the description in the Guide will have higher priority.
- To request a repair at your charge, contact your supplier or local Hitachi Distributor.

### 4.4.5 Changes in Product Specification

- Note that specifications mentioned in the catalogs, product guides or technical documents are subject to change without notice.

### 4.4.6 Notes for Applying the Product

- Make sure to follow the conditions of use, handling instructions and notes as stated in the User's Guide of the product.
- Make sure in advance that the inverter is allocated and installed appropriately for your purpose in the whole system.
- Be sure to observe the following when using the inverter:
  - (1) Use of the inverter maintaining the safety margin in rating and performance;
  - (2) Ensured safety design with enough redundancy;
  - (3) Ensured safety design that can minimize risks to your facilities in the event of a failure of the inverter;
  - (4) Construction of the whole system based on safety measures that allows you to notify the user of potential risks; and
  - (5) Periodical maintenance of the inverter and your facilities
- The inverter is designed and manufactured as a product for general industrial products. Therefore the inverter is not meant to be used for the following purposes, and if you use the inverter for these purposes, our company shall provide no warranty for the inverter, unless otherwise specially agreed.
  - (1) Special purposes such as aerospace, nuclear energy, electricity, riding a mobile vehicle, medical care and submarine relay equipment; and
  - (2) Purposes that may significantly affect human lives or properties such as manned elevators, amusement facilities and medical devices
- If you have no special quality requirements in the limited use of the inverter for the above purposes, please contact our sales department to verify the applicability.
- The inverter is meant for an induction motor [IM] (three-phase motor)/synchronous motor (permanent-magnet motor) [SM(PMM)] (three-phase motor). Make an inquiry to us about the use for loads other than the above.

### 4.4.7 Supplement

- See "Chapter 19 Maintenance and Inspection" for service life-limited parts.
- For optional devices, refer to the instruction manual provided together with each device.
- This warranty does not limit the legal rights of customers of the product.
- This warranty is valid only in Japan. — This warranty is valid only in Japan. —
- Please contact your supplier for the warranty of any product you purchased overseas.

## 5





## Chapter 5 Included Items

### Contents

5.1 What This Chapter Explains .....	5-1
5.2 Included Items .....	5-2
5.3 Inspection upon Purchase .....	5-3
5.3.1 Checking When Opening the Package .....	5-3
5.3.2 User's Guide (the Guide) .....	5-3

### 5.1 What This Chapter Explains

This chapter describes included items that need to be checked upon purchase.

Symbol	Meanings
	General and troubleshooting questions
	Key points for a solution
	Notes
	Confirmation of procedures

5.2 Included Items



- What's included with the product



- Check included items.

The following is included in the package:

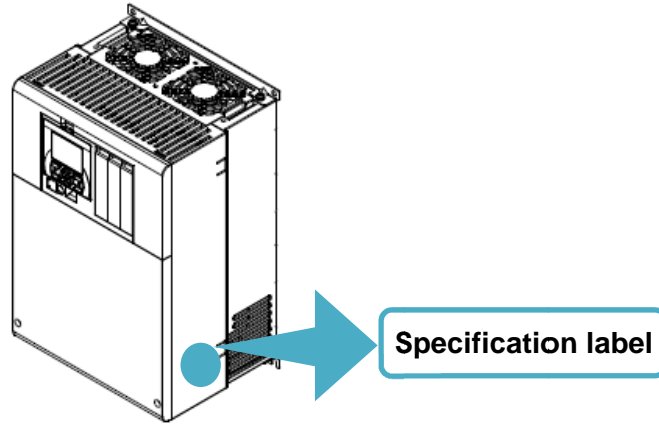

- Included Items



Inverter body: 1



Basic Guide: 1

- Included items that vary depending on models (enclosed in the package)

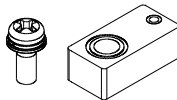

\* Available only for P1-01240-L(P1-220L)  
 M3x8 screw: 4  
 Spacer: 4



Eye bolts for hanging the inverter  
 P1-01850-L (P1-370L) - P1-02290-L (P1-550L)  
 P1-00930H (P1-370H) - P1-01470-L (P1-550H)

Inverter body

Confirm that the model you ordered and the model name on the specification label are the same. Find an inverter in the package.

Basic Guide

Enclosed as a booklet. Following this guide allows you to do a test run and set simple settings.



• Applying a different inverter voltage class or motor rated voltage from the specified input power voltage may lead to damage to your inverter or motor burnout.



• Check with the specification label to be sure that the inverter voltage class is correct.

\* See "4.3.2 Specification Label".

### 5.3 Inspection upon Purchase





- What's needed to be checked upon purchase

#### 5.3.1 Checking When Opening the Package



- Check the items on the right when you open the package.
- If you find any faults or defects in the product or have any question about the product, contact your supplier or our sales department shown on the back cover.

 Check the product for damage (including falling of parts and dents in the inverter body) caused during transportation.

 Upon opening the product package, check that the package contains an inverter set and the Basic Guide.

#### 5.3.2 User's Guide (the Guide)



- The Guide describes how to handle and maintain the Hitachi SJ series inverter type P1. Read the Guide carefully before using the inverter. Keep the "User's Guide" at hand.
- If you use the inverter with optional products, you should also read the instruction manuals enclosed with those products.
- Note that the Basic Guide and the instruction manuals for each optional product to be used should be delivered to the end user of the inverter. For the User's Guide and instruction manual, download the latest version.

 Check the specification label again to confirm that the product is the one you have ordered.

(Memo)



## Chapter 6 Installation

---

### Contents

6.1 What This Chapter Explains .....	6-1
6.2 Installation Environment .....	6-2
6.3 External dimensions .....	6-6

### 6.1 What This Chapter Explains

---

This chapter describes the installation of the inverter. Before installing the inverter, make sure to carefully read “Chapter 1 Safety Instructions/Risks” for safety work.



6.2 Installation Environment

◆ Transportation



The inverter uses plastic parts. When carrying the inverter, handle it carefully to prevent damage to the parts.



Do not install and operate the inverter if it is damaged or parts are missing.



Do not carry the inverter by holding the front or terminal block cover. Doing so may cause the inverter to fall.



Fall

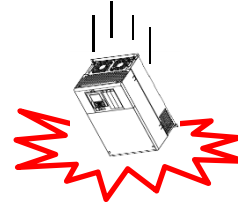

◆ Ambient temperature



Avoid installing the inverter in a place where the ambient temperature goes above or below the allowable range, as defined by the standard inverter specification.



Leave sufficient space around the inverter. Measure the temperature in a position about 5 cm from the bottom-center point of the inverter, and check that the measured temperature is within the allowable range. Operating the inverter at a temperature outside this range will shorten the inverter life (especially the capacitor life).



Temperature requirements

\* Temperature requirements vary depending on the selected load rating. See "Chapter 20 Specifications". Carrier derating may be required.

◆ Humidity



Avoid installing the inverter in a place where the relative humidity goes above or below the allowable range (20% to 90% RH), as defined by the standard inverter specification. Avoid a place where the inverter is subject to condensation.



Condensation inside the inverter will result in short circuits and malfunctioning of electronic parts. Also avoid places where the inverter is exposed to direct sunlight.



20 to 90%RH



Water drops



Direct sunlight

◆ Ambient air



Avoid installing the inverter in a place where the inverter will be subject to dust, water drops, corrosive gases, combustible gases, flammable gases, grinding fluid mist, or salt water.



Foreign particles entering the inverter will cause it to fail. If you use the inverter in a considerably dusty environment, install the inverter inside a totally enclosed panel.



◆ Installation method and position



Install the inverter vertically and securely with screws or bolts on a surface that can bear the inverter weight and is free from vibrations.



If the inverter is not installed vertically, its cooling performance may be degraded and tripping or inverter damage may result.

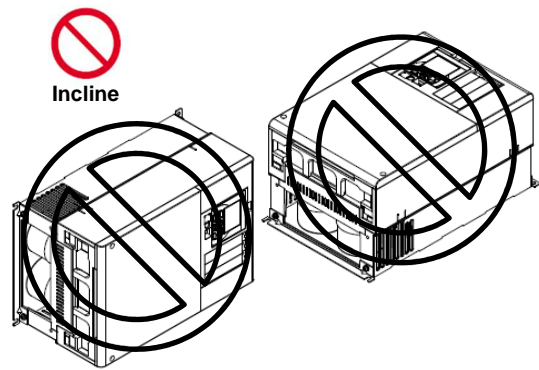
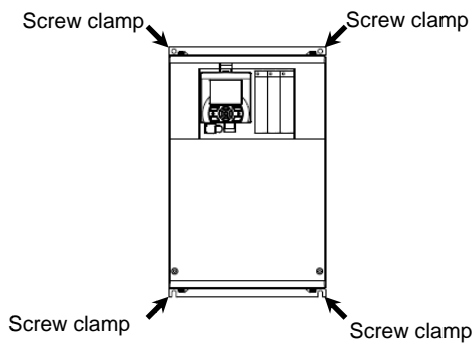

◆ Mounting in an enclosure



When mounting multiple inverters in an enclosure with a ventilation fan, carefully design the layout of the ventilation fan, air intake port, and inverters. An inappropriate layout will reduce the inverter-cooling effect and raise the ambient temperature. Plan the layout so that the inverter ambient temperature will remain within the allowable range. A ventilation fan located directly above the inverter could drop dust on it. To prevent this, move the inverter horizontally to a suitable position.

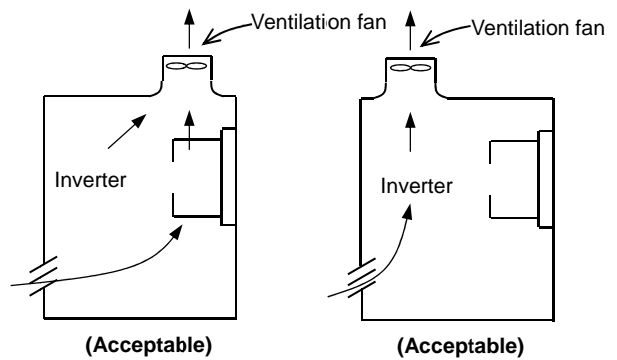

Position of ventilation fan

◆ Surface on which to install the inverter



The inverter will reach a high temperature (up to about 150°C) during operation. Install the inverter on a vertical wall surface made of nonflammable material (e.g., metal) to avoid the risk of fire.



Leave sufficient space around the inverter. Keep sufficient distance between the inverter and other heat sources (e.g., braking resistors and reactors) so that the heat discharged from the heat sources does not affect the inverter.

For  
P1-00044-L to P1-01240-L (P1-004L to P1-220L);  
P1-00041-H to P1-00620-H (P1-007H to P1-220H)

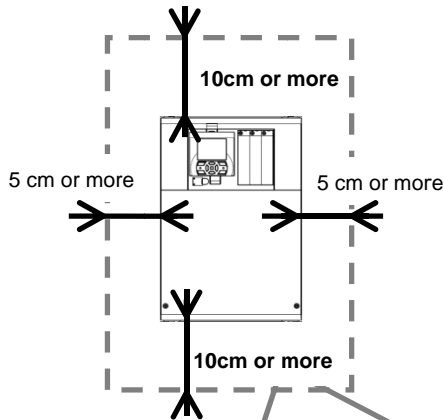

For  
P1-01530-L to P1-02950-L (P1-300L to P1-550L);  
P1-00770-H to P1-01470-H (P1-300H to P1-550H)

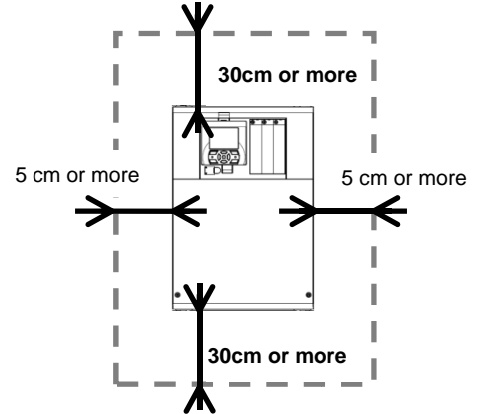

\* A clearance of 22 cm or more is required below the inverter to replace aged parts for the following models:  
 • P1-00800-LFF (P1-150LFF) to P1-01240-LFF (P1-220LFF)  
 • P1-00400-HFF (P1-150HFF) to P1-00620-HFF (P1-220HFF)  
 \* The inverter needs to be removed to replace aged parts for the following models:  
 • P1-00330-LFF (P1-055LFF) to P1-00600-LFF (P1-110LFF)  
 • P1-00175-HFF (P1-055HFF) to P1-00310-HFF (P1-110HFF)

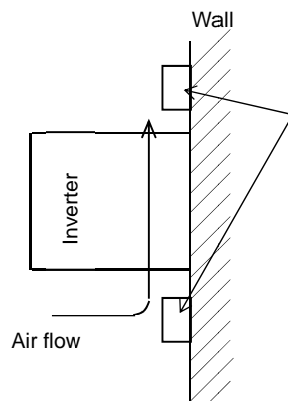

Keep enough clearance between the inverter and the wiring ducts located above and below the inverter to prevent the latter from obstructing the ventilation of the inverter.

\* See "Chapter 20 Specifications" for the dimension drawing of the inverter.

### ◆ Reduction of enclosure size



The heat sink of the inverter is positioned outside the enclosure, so that the amount of heat produced inside the enclosure can be reduced and likewise the size of the enclosure can also be reduced. Mounting the inverter in an enclosure with the heat sink positioned outside requires an optional dedicated special metal fitting. To mount the inverter in an enclosure with the heat sink positioned outside, cut out the enclosure panel according to the specified cutting dimensions.



The cooling section (including the heat sink) positioned outside the enclosure has a cooling fan. Therefore, do not place the enclosure in any environment where it will be subject to dust, water drops, corrosive gases, combustible gases, flammable gases, grinding fluid mist, or salt water.



**Entering  
foreign  
matters**

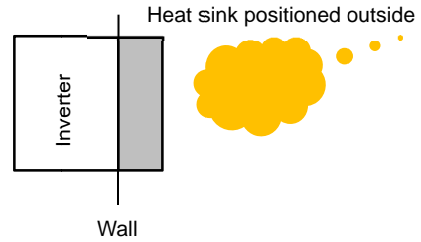

\* See “Chapter 20 Specifications” for the efficiency of the inverter.

6.3 External dimensions

Model P1-****-(P1-****)			
200 V class: 00044-L (004L), 00080-L (007L), 00104-L (015L), 00156-L (022L) , 00228-L (037L)			
400V class: 00041-H (007H), 00054-H (015H), 00083-H (022H), 00126-H(037H)			
Dimension	W(mm)	H(mm)	D(mm)
	150	255	140

(Example of description)

See "Chapter 20 Specifications" for corresponding details.

For example, 00330-L(055L) indicates that VLD rated current is 33.0A (ND rated motor capacity is 5.5kW), and L indicates 200V class while H indicates 400V class.

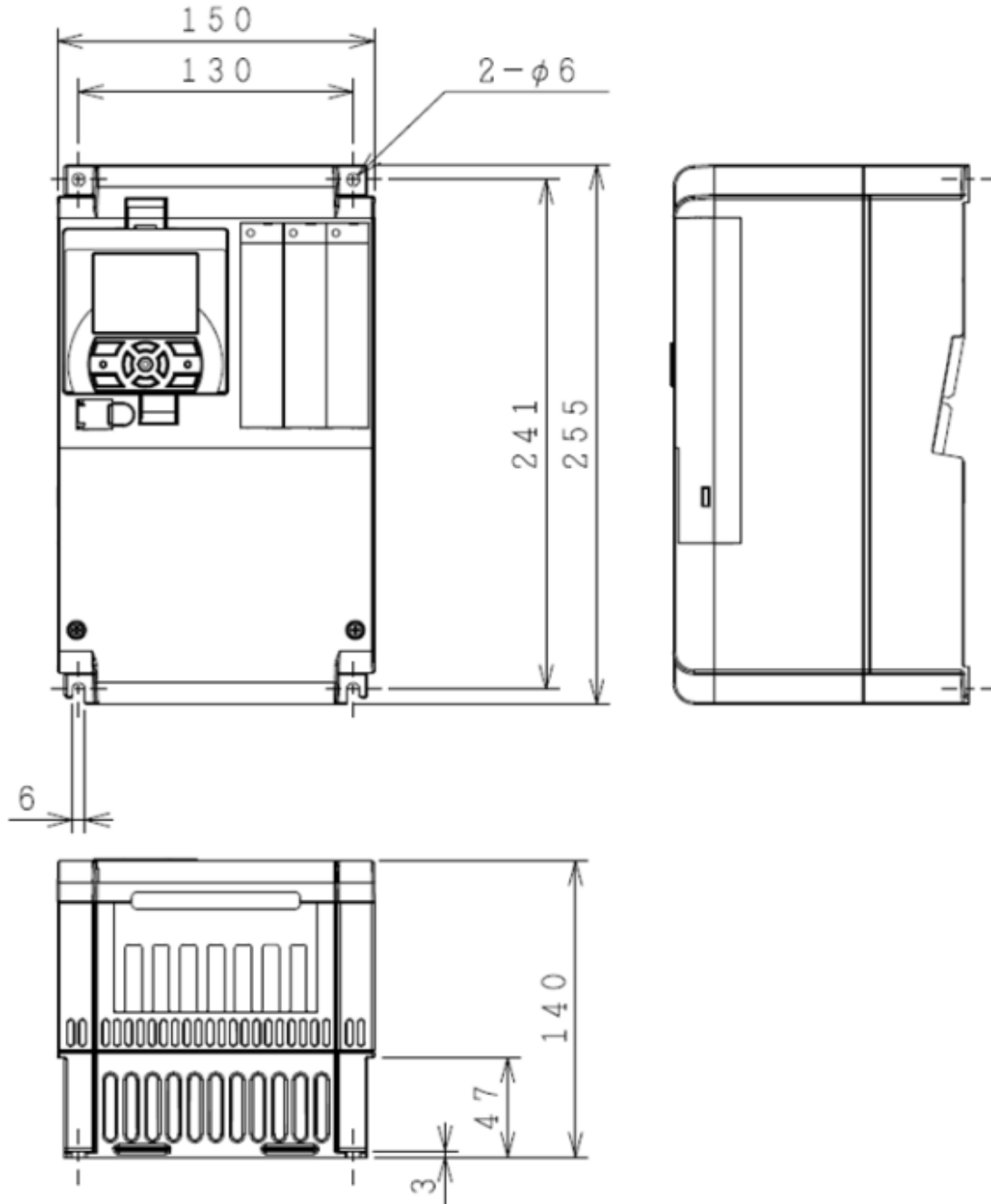

Model P1-****-(P1-****)			
200V class: 00330-L(055L), 00460-L(075L), 00600-L(110L)			
400V class: 00175-H(055H), 00250-H(075H), 00310-H(110H)			
Dimension	W (mm)	H (mm)	D (mm)
	210	260	170

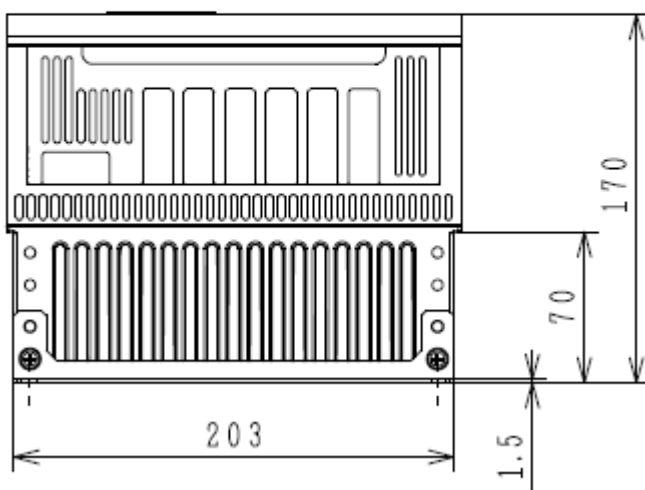
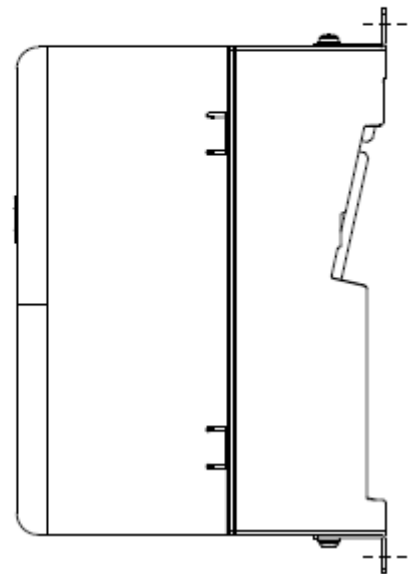
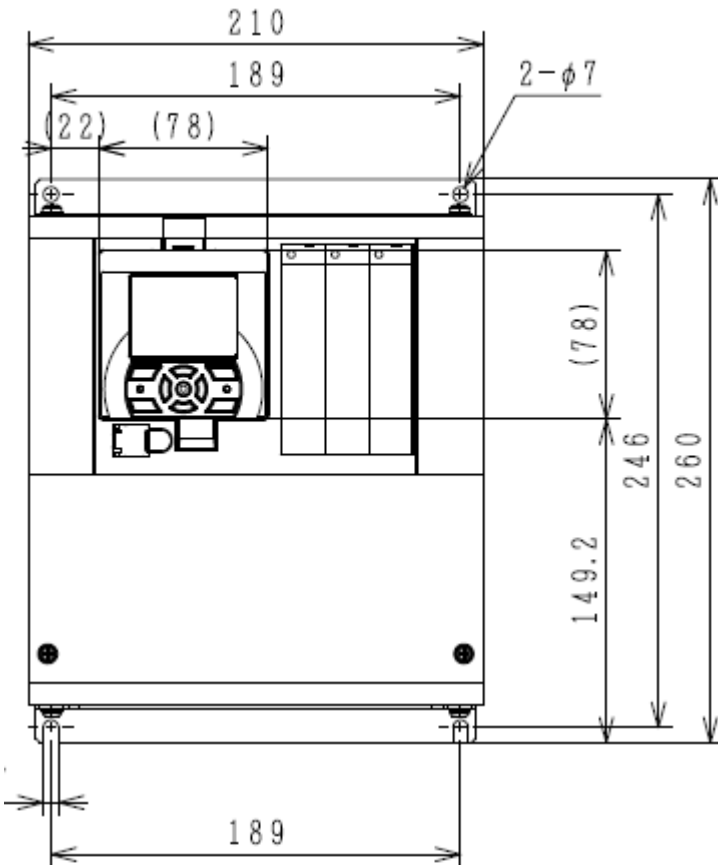

◆ Notes for P1-00600-L (P1-110L)



For the use of P1-00600-L (P1-110L) at low duty (LD)/very low duty (VLD), follow the installation procedures shown in the figure below.

Change [Ub-03] to 00 and [Ub-03] to 01 to set VLD and LD, respectively.

Procedures:

- (1) Remove four truss head screws that hold the (upper and lower) brackets provided by factory configuration.
- (2) Change the position of the screw holes for the (upper and lower) brackets.
- (3) Tighten the (upper and lower) brackets using four truss head screws removed in (1). (Tightening torque 2.2 to 2.5 Nm)
- (4) Install P1-00600-L (P1-110L) on the wall using four screws prepared on your own.

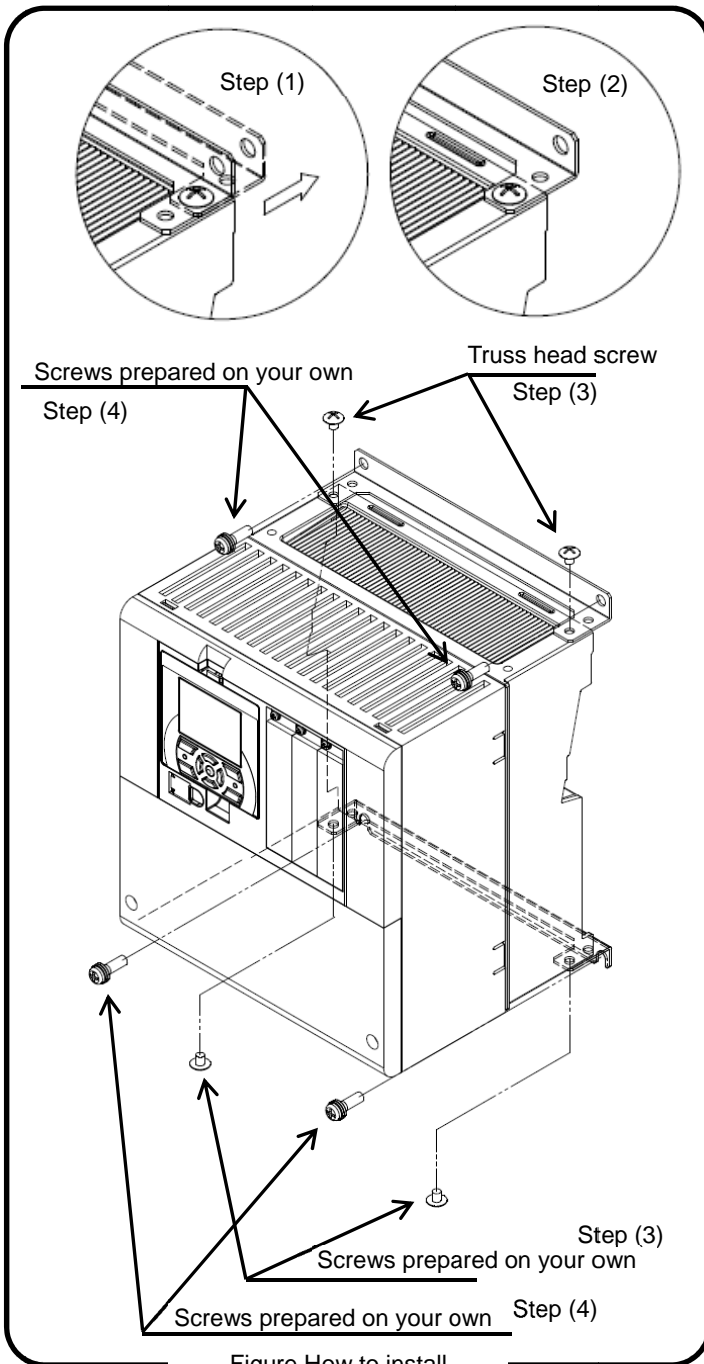

Figure How to install

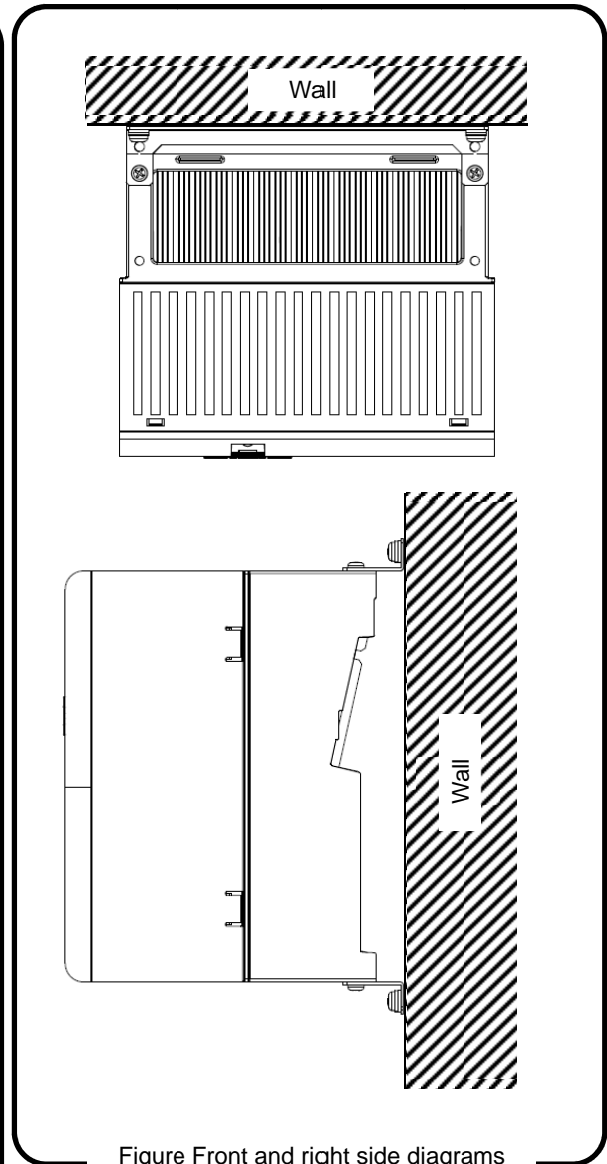
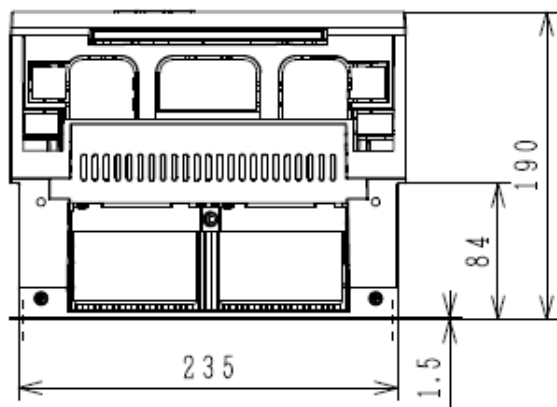
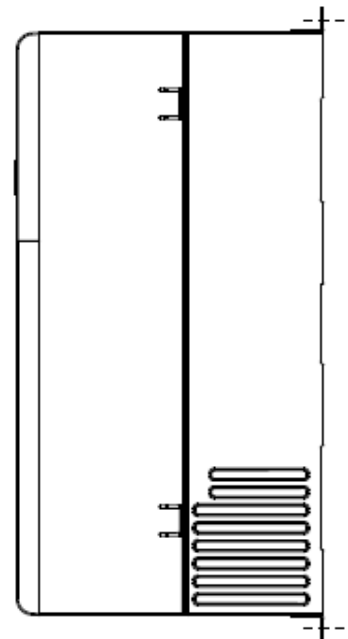
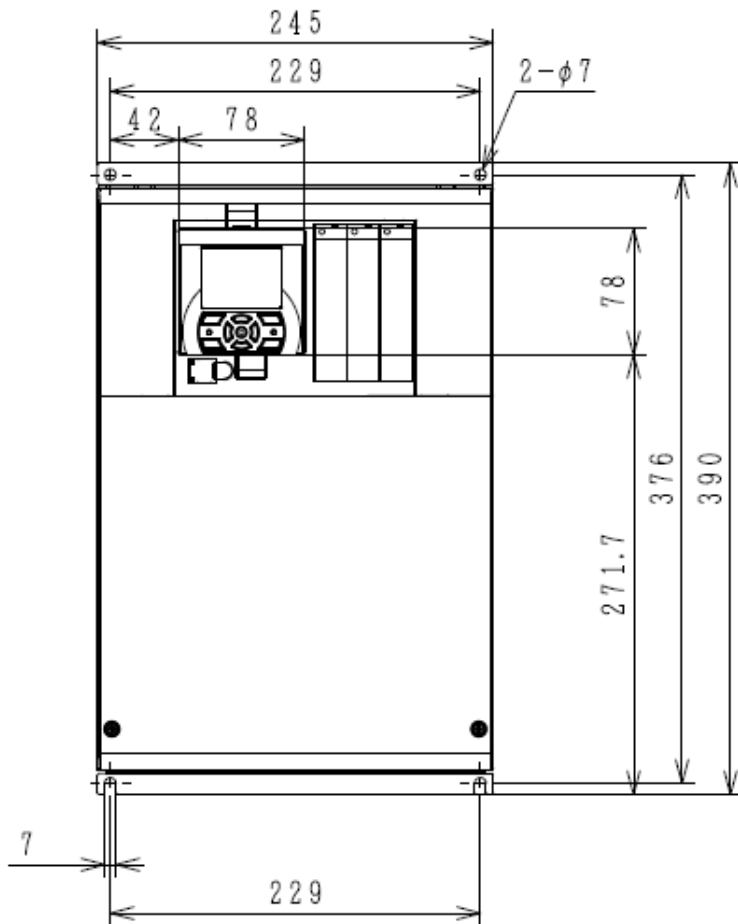

Figure Front and right side diagrams

Model P1-****-(P1-****)			
200V class: 00800-L (150L), 00930-L (185L), 01240-L (220L)			
400V class: 00400-H (150H), 00470-H (185H), 00620-H (220H)			
Dimension	W (mm)	H (mm)	D (mm)
	245	390	190





◆ Notes for P1-01240-L (P1-220L)



For the use of P1-01240-L(P1-220L) at very low duty (VLD), follow the installation procedures shown in the drawings below.

Change [Ub-03] to 00 to set VLD.

Procedures:

- (1) Tighten (four) spacers to the (upper and lower) brackets as shown in Figure 1 using (four) M3x8 screws included in the package. (Tightening torque 0.6 to 0.8 Nm)
- (2) Install P1-01240-L(P1-220L) on the wall using four screws prepared on your own.

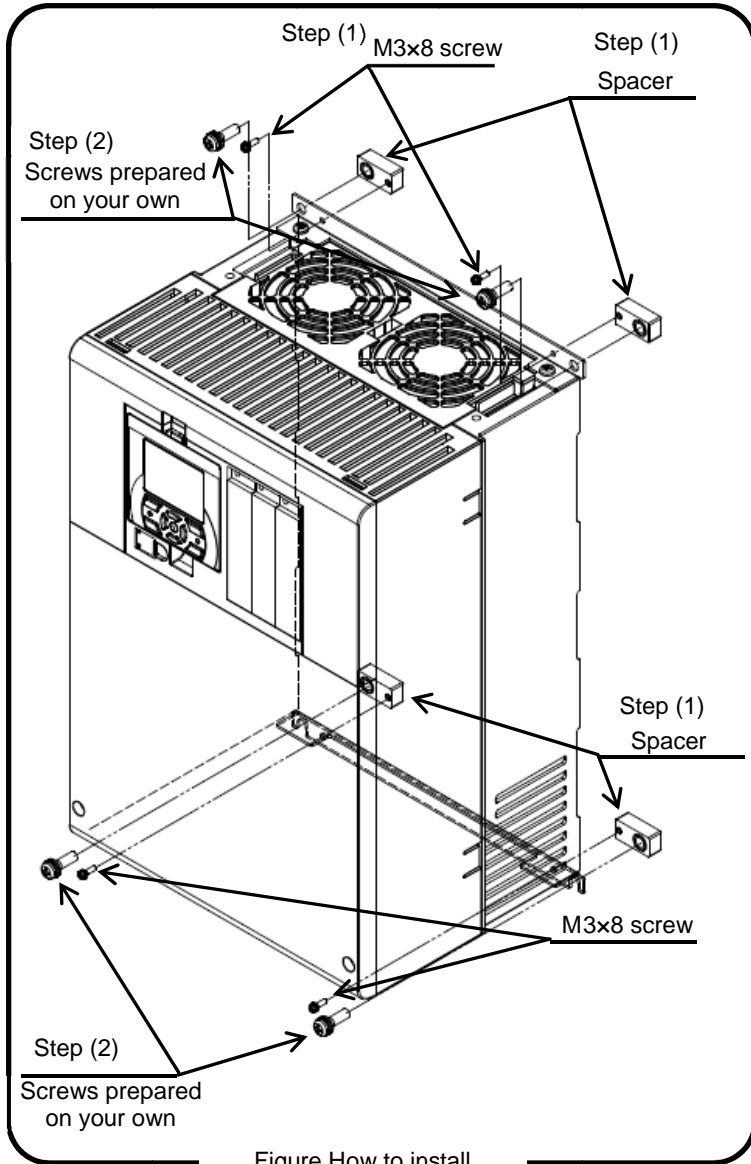

Figure How to install

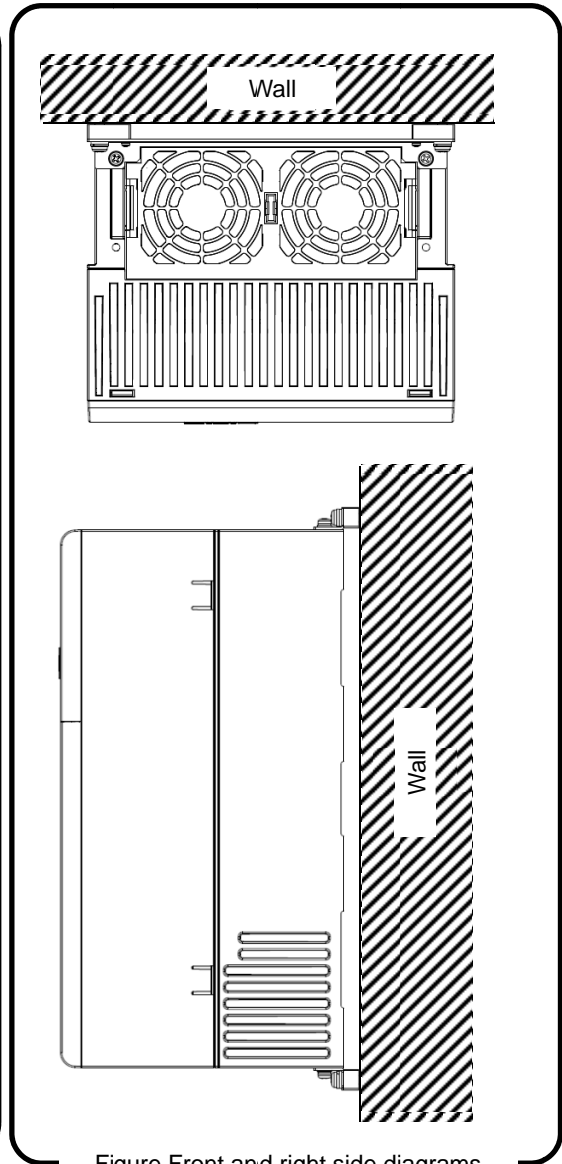
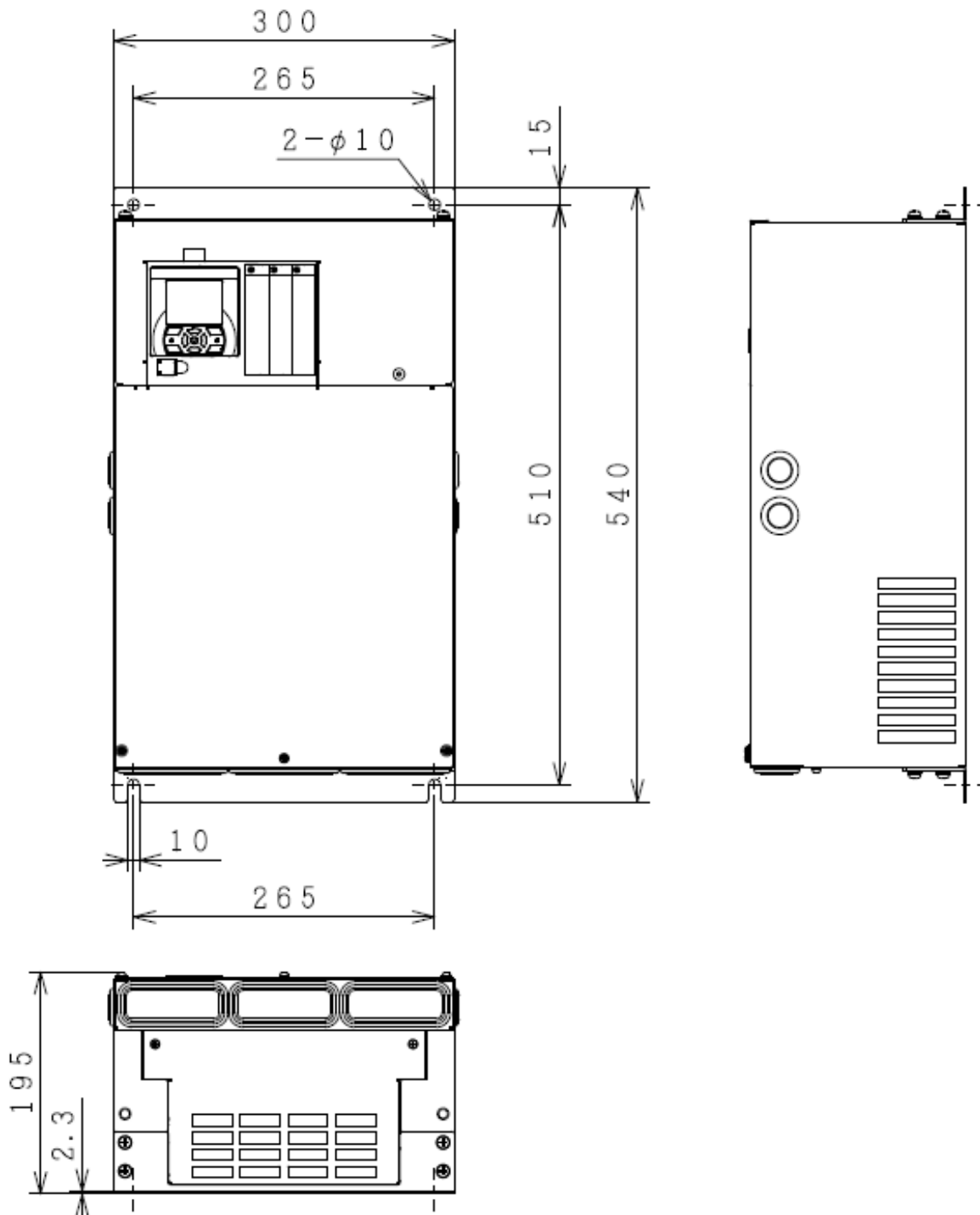
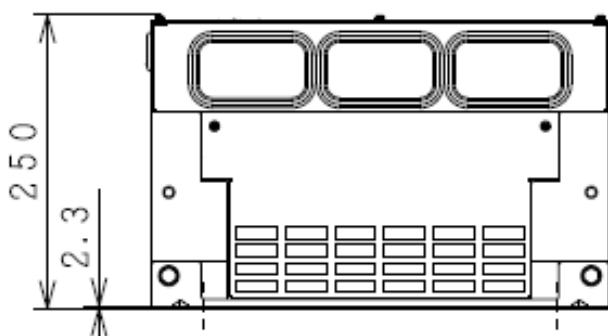
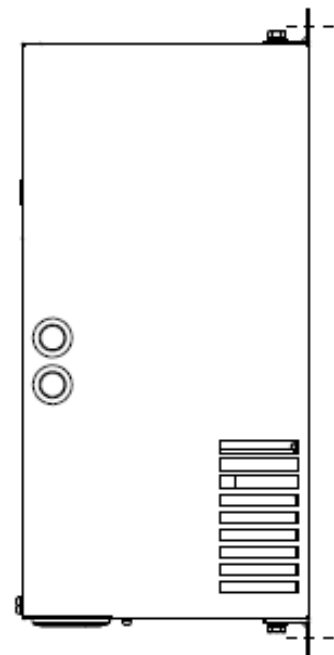
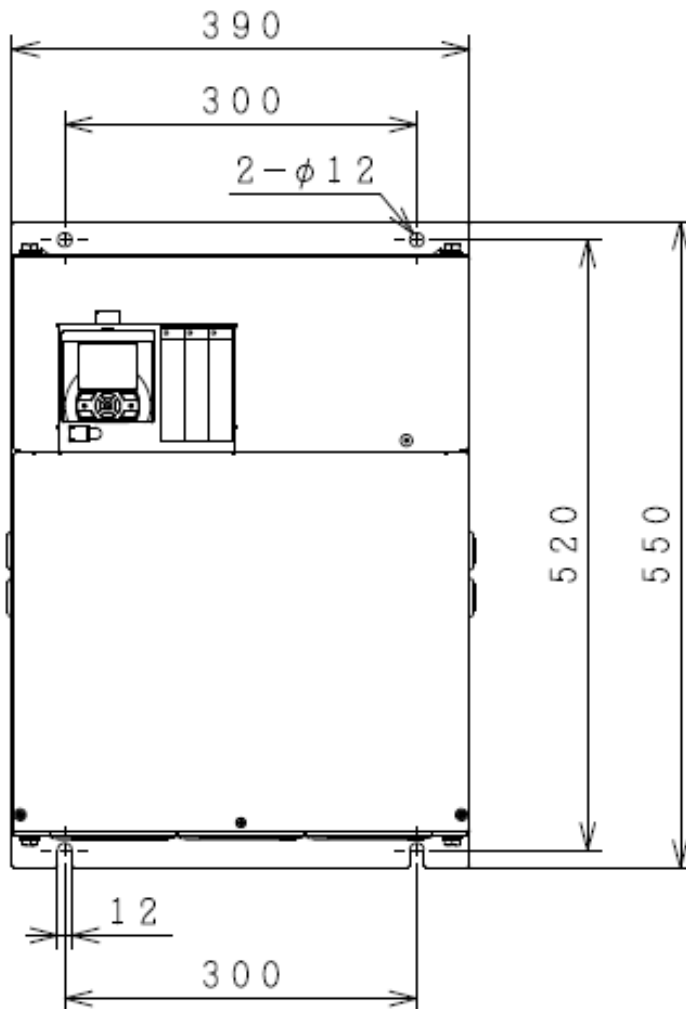

Figure Front and right side diagrams

<b>Model P1-****-(P1-****)</b>			
200V class: P1-01530-L (P1-300L)			
400V class: P1-00770-H (P1-300H)			
Dimension	W (mm)	H (mm)	D (mm)
	300	540	195



Model P1-****-(P1-****)			
200V class: P1-01850-L (P1-370L), P1-02290-L (P1-450L)			
400V class: P1-00930-H (P1-370H), P1-01160-H (P1-450H), P1-01470-H (P1-550H)			
Dimension	W (mm)	H (mm)	D (mm)
	390	550	250



<b>Model P1-****-(P1-****)</b>			
200V class: P1-02950-L (P1-550L)			
<b>Dimension</b>	W (mm)	H (mm)	D (mm)
	480	700	250

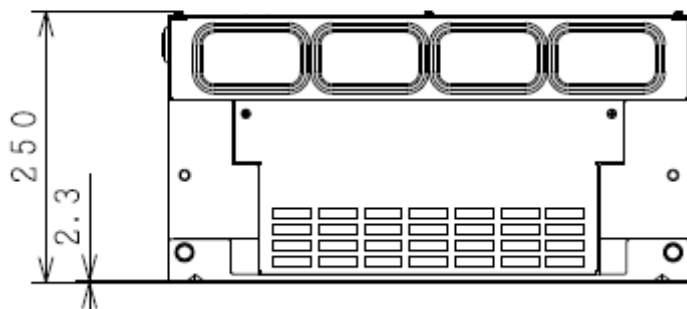
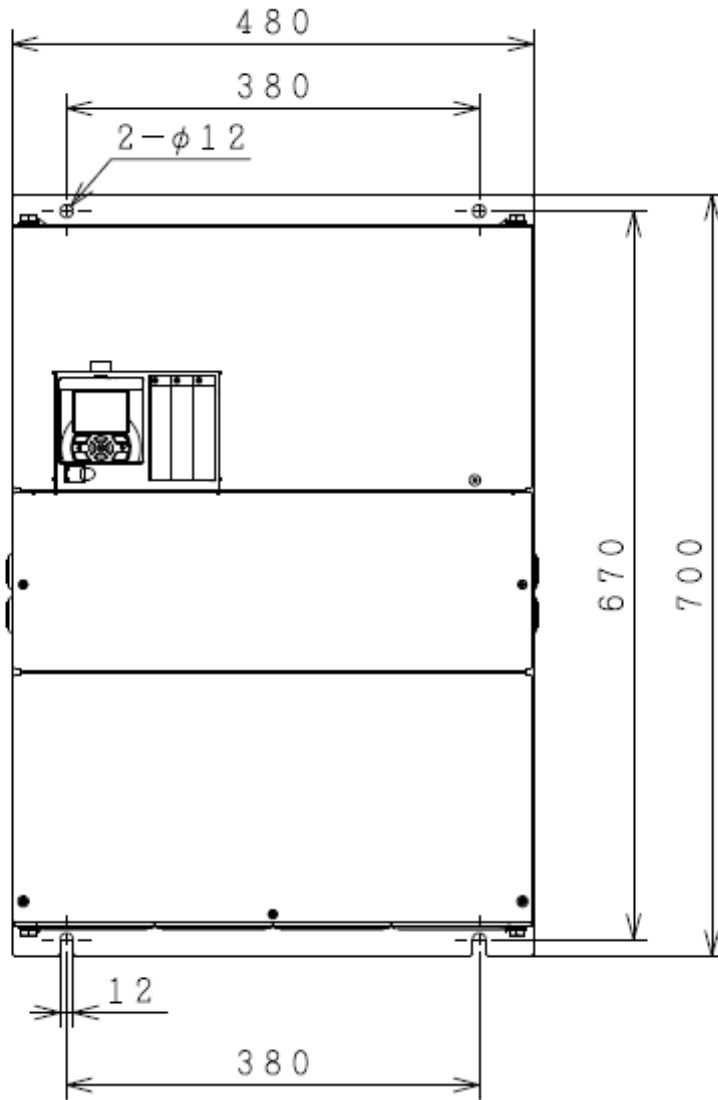

Model P1-****-(P1-****)			
400V class: P1-01760-H(750H), P1-02130-H(900H)			
Dimension	W (mm)	H (mm)	D (mm)
	390	700	270

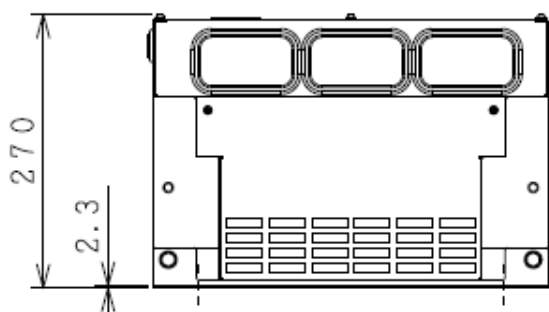
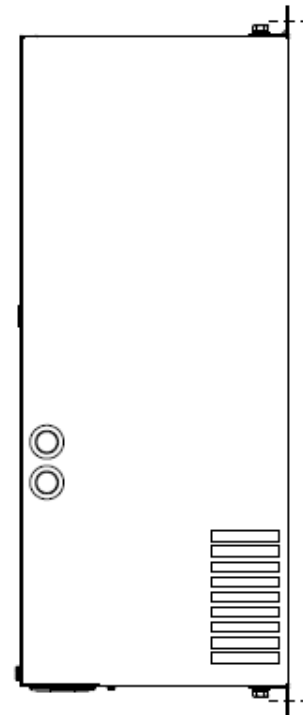
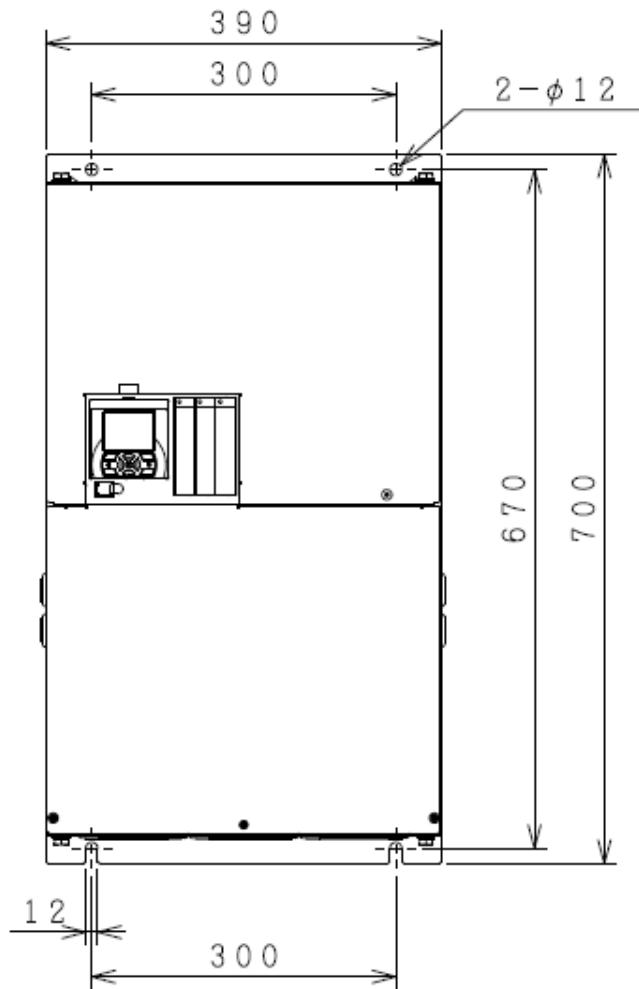

<b>Model P1-****-(P1-****)</b>			
400V class: P1-02520-H(1100H), P1-03160-H(1320H)			
<b>Dimension</b>	W (mm)	H (mm)	D (mm)
	480	740	270

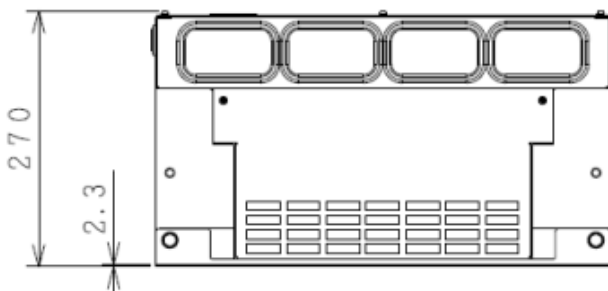
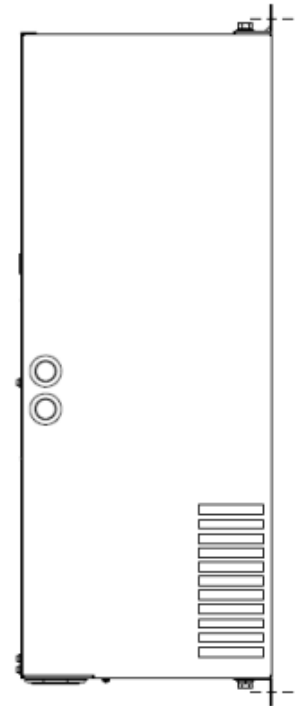
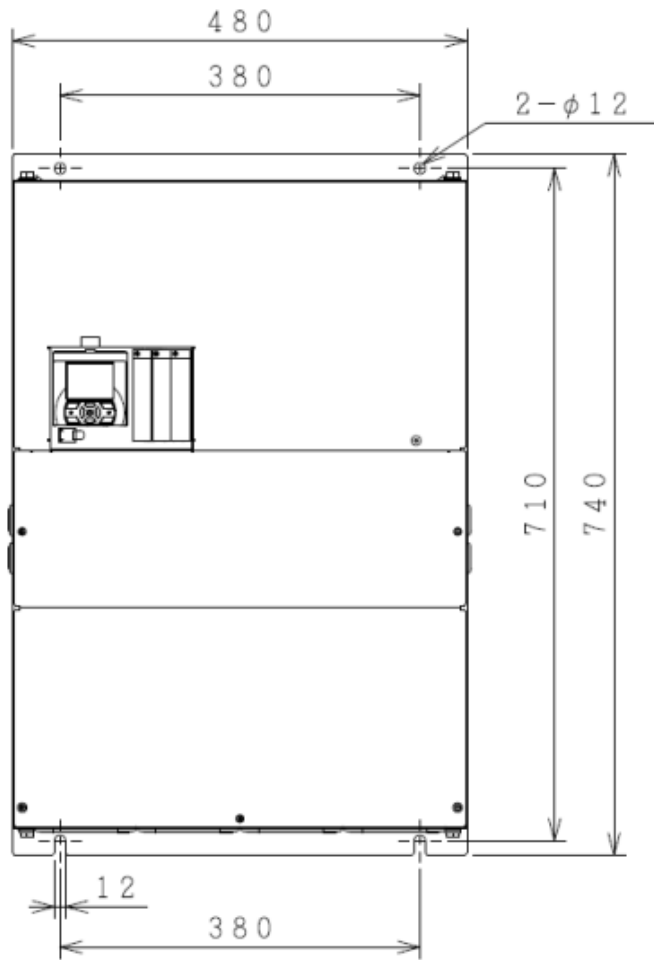

(Memo)







## Chapter 7 Wire Connection and Optional Devices

### Contents

- 7.1 What This Chapter Explains ..... 7-1
- 7.2 Remove the Terminal Block Cover ..... 7-2
- 7.3 Use the Backing Plate ..... 7-3
- 7.4 Check a Terminal Connection Example ..... 7-4
- 7.5 Connect Wire to the Main Circuit Terminal Block..... 7-6
  - 7.5.1 Configuration of Main Circuit Terminal Block ..... 7-6
  - 7.5.2 Description of Main Circuit Terminal Block ..... 7-6
  - 7.5.3 What Can Be Done with Main Circuit Terminal Block..... 7-7
  - 7.5.4 Recommended Wire Diameter, Wiring Tools, and Crimping Terminals..... 7-9
  - 7.5.5 Applicable Breakers.....7-11
  - 7.5.6 Wiring Locations ..... 7-13
  - 7.5.7 Wiring to Power Supply and Motor ..... 7-17
  - 7.5.8 Wiring Separately to the Control Circuit Power Supply ..... 7-18
  - 7.5.9 Outline of Applicable Peripheral Devices..... 7-19
  - 7.5.10 DC Reactor Connection Terminal (PD,P)..... 7-20
  - 7.5.11 Regenerative Braking Option..... 7-21
  - 7.5.12 Connection Terminals for External Braking Resistor (P, RB) ..... 7-21
  - 7.5.13 Inverter Earth Terminal (G) ..... 7-22
  - 7.5.14 Enable the Internal EMC Filter..... 7-22
- 7.6 Operation and Optional Areas ..... 7-23
  - 7.6.1 Structure of Operation and Optional Areas ..... 7-23
  - 7.6.2 Description of Operation and Optional Areas .. 7-23
  - 7.6.3 Take Out the Operator Keypad on the Panel... 7-24
- 7.7 Control Circuit Terminal Area ..... 7-25
  - 7.7.1 Switch Configuration..... 7-25
  - 7.7.2 Wiring to the Control Circuit Terminal Block..... 7-26
  - 7.7.3 Wiring Portion Under Control Circuit..... 7-28
  - 7.7.4 Wiring Portion Above Control Circuit ..... 7-31

### 7.1 What This Chapter Explains

This chapter describes wiring to the inverter and peripheral options. Before connecting wires with the inverter and installing optional devices, make sure to carefully read “Chapter 1 Safety Instructions/Risks” for safety work.

Symbol	Meanings
	General and troubleshooting questions
	Key points for a solution
	Notes
	Confirmation of procedures



## 7.2 Remove the Terminal Block Cover

**Q**

- We want to know the condition of terminal block when the cover is removed.

**A**

- By removing the cover of the terminal block, you can check the control circuit terminal block. By removing the wiring separation plate and backing plate, you can check the main circuit terminal block.

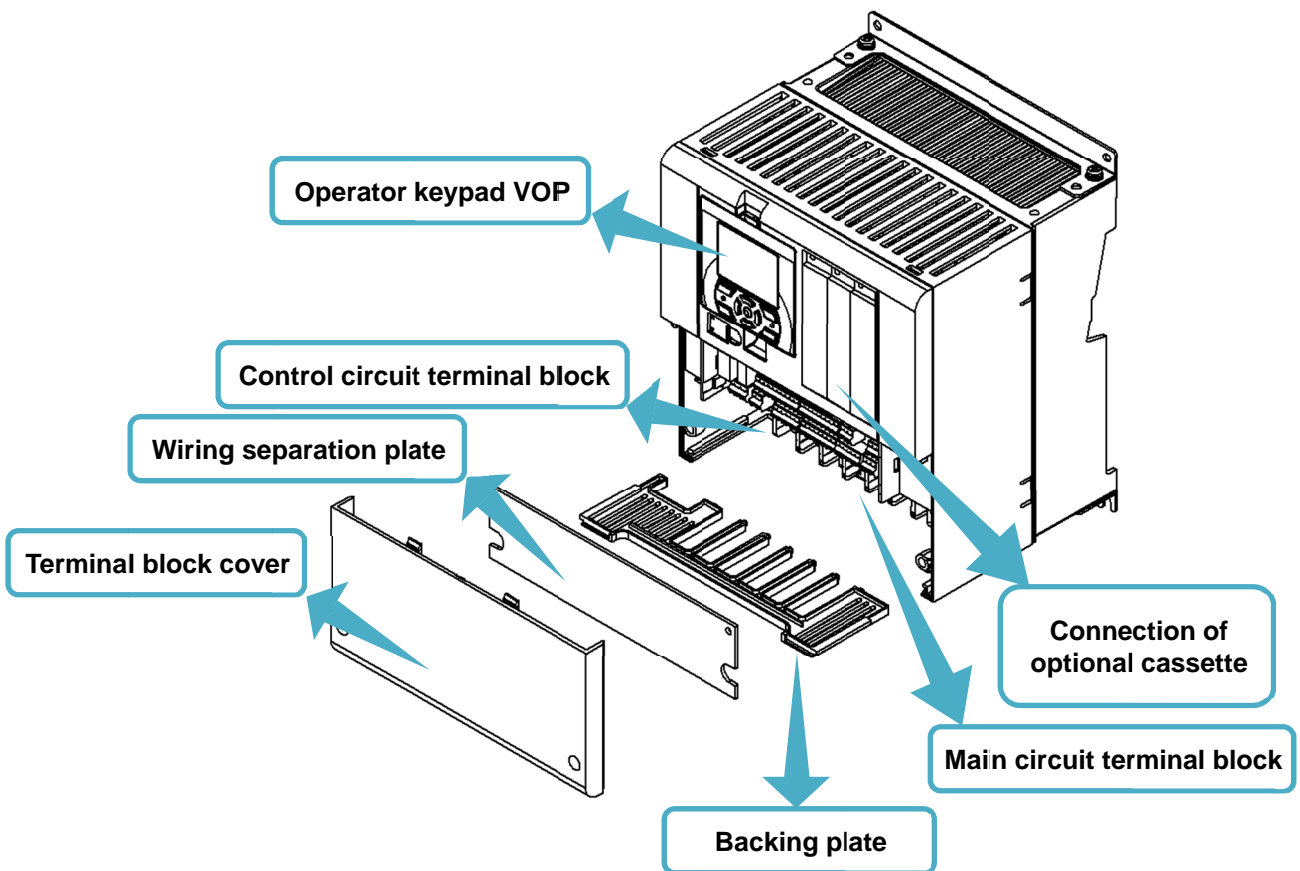

7.3 Use the Backing Plate



- When connecting wires to apply high voltage on the AL terminal, draw out the plate separately from the wiring of control circuit.

■ Backing plate (i)

P1-00330-LFF~P1-00600-LFF (P1-055LFF~P1-110LFF)  
 P1-00175-HFF~P1-00310-HFF (P1-055HFF~P1-110HFF)

■ Backing plate (ii)

P1-00800-LFF~P1-01240-LFF (P1-150LFF~P1-220LFF)  
 P1-00400-HFF~P1-00620-HFF (P1-150HFF~P1-220HFF)



- Cut the connections between the unnecessary part and backing plate using nippers, radio pliers, or cutter, to cut off the unnecessary part for wiring.

■ Backing plate (iii)

P1-01250-L (P1-300L)~P1-01540-L (P1-550L)/  
 P1-00770-H (P1-300H)~P1-03610-H (P1-1320H)



1. When a conduit tube is not connected  
 Cut the rubber bushing to create a notch using nippers or a cutter for wiring.
2. When a conduit tube is connected  
 Remove the rubber bushing in the portion where a conduit tube is to be connected, and then connect the conduit tube.

Please contact the sales officer of our company for the latest information.

• Backing plate (i)

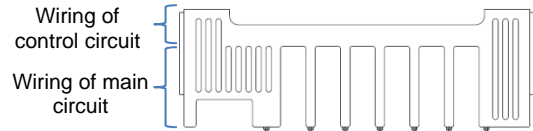

• Backing plate (ii)

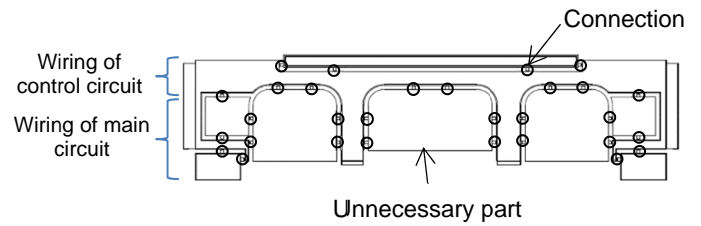

• Backing plate (iii)

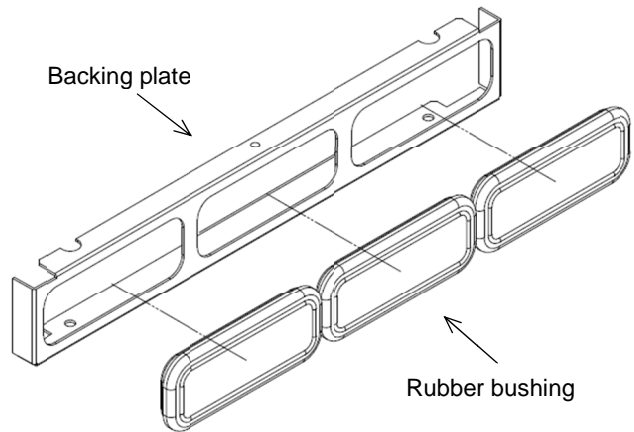

Electric shock  
 Ground fault

Do not remove rubber busings from the wiring section unless a conduit tube is connected. Doing so may cause the edge of backing plate to damage the cable sheath, leading to short circuit or ground fault.

7.4 Check a Terminal Connection

Example

■ Outline of main circuit

\* The RB terminal is mounted only on models equipped with the drive circuit for braking resistor.

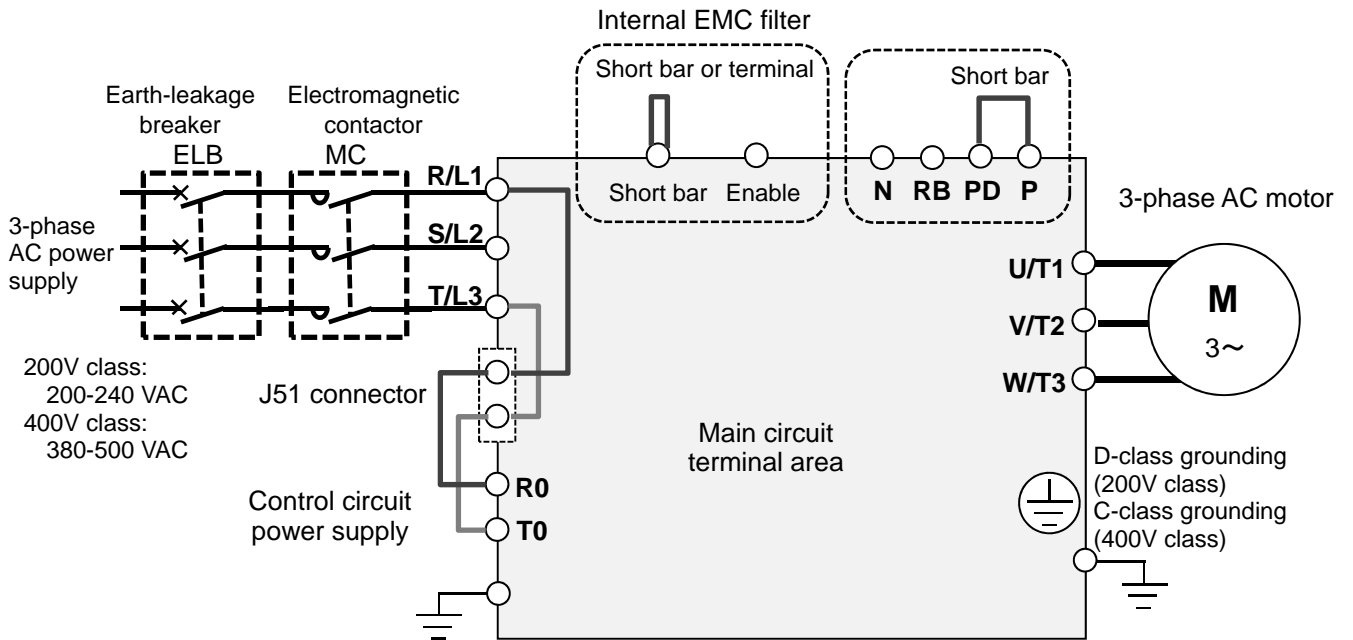

■ Outline of operation section

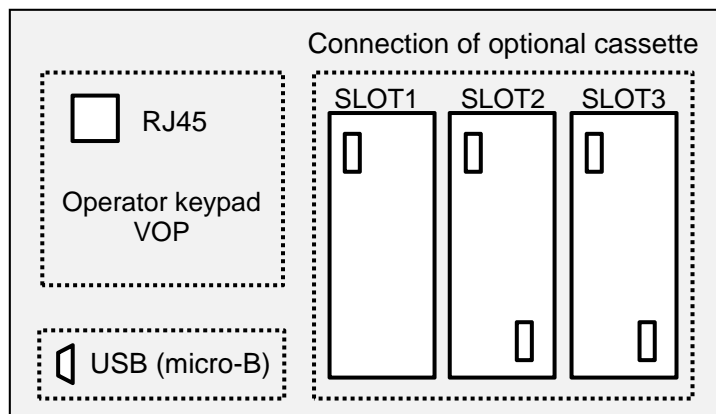

■ Outline of control circuit

\* The following shows an example of sink logic

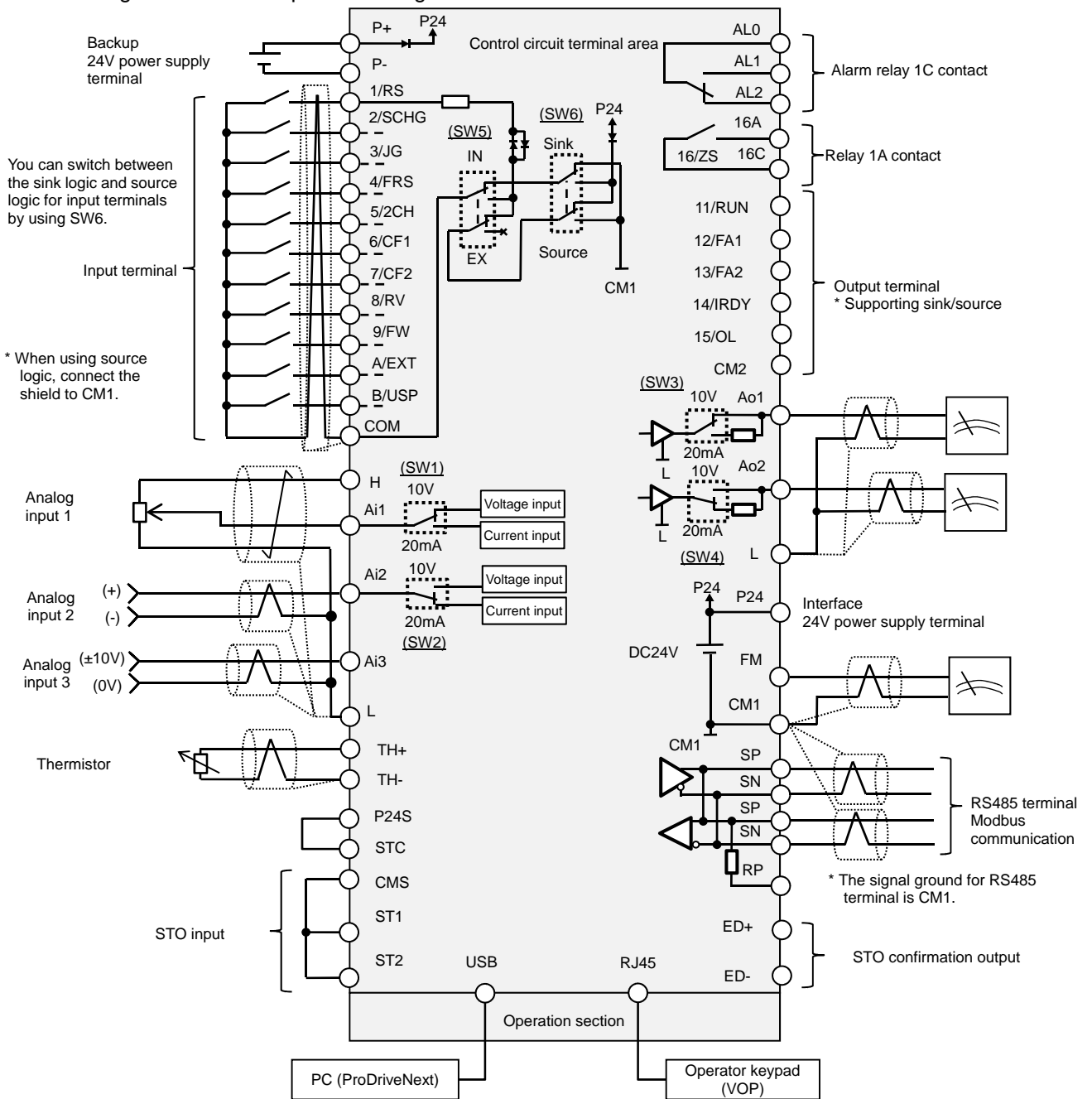

## 7.5 Connect Wire to the Main Circuit Terminal Block

### 7.5.1 Configuration of Main Circuit Terminal Block

\* The RB terminal is mounted only on models equipped with the drive circuit for braking resistor.

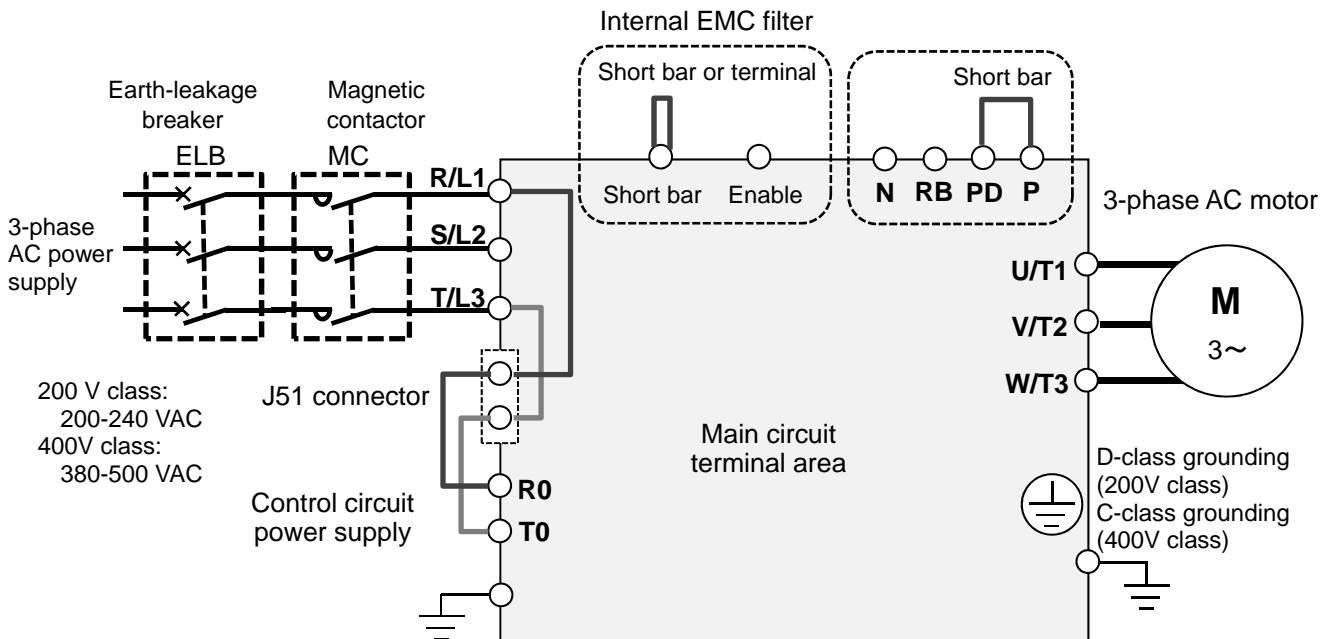

- ✓ Selection of EMC filter (factory default state)  
 The EMC filter is disabled:  
 Model P1-\*\*\*\*\*-FF and P1-\*\*\*\*\*-FUF  
 The EMC filter is enabled:  
 Model P1-\*\*\*\*\*-FEF and P1-\*\*\*\*\*-FCF

- ✓ Short circuit between P and PD (factory default state)  
 When shipped from the factory, P and PD are short-circuited. If P and PD are not connected, power is not supplied to the main circuit, which disables operation.

### 7.5.2 Description of Main Circuit Terminal Block

Terminal symbol	Terminal name	Description
R,S,T (L1,L2,L3)	Input terminal for main power supply	Connect to the AC power supply. Do not connect these terminals to the AC power supply when using the harmonic suppression unit HS900A series.
U,V,W (T1,T2,T3)	Inverter output terminal	Connect to the 3-phase motor.
PD,P (+,+)	DC reactor connection terminal	Remove the short bar between PD and P terminals, and connect the optional reactor DCL for improving power factor.
P,RB (+,RB)	Connection terminal for external braking resistor	Connect the optional external braking resistor. For models equipped with the braking resistor circuit, see "Chapter 20 Specifications". Models not equipped with the braking resistor circuit does not have the RB terminal.
P,N (+,-)	Connection terminal for regenerative braking unit	Connect the optional regenerative braking unit BRD, regenerative converter RC700, and harmonic suppression unit HS900A.
⊕	Inverter earth terminal	The earth terminal for the Inverter case. Please connect this terminal to the ground. Conduct class-D ground work for 200V class, and class-C ground work for 400V class.

**7.5.3** What Can Be Done with Main Circuit Terminal Block

■ Points to be noted on main circuit terminals



Electric shock

- Make sure to check that the charge lamp is off before performing wiring. Once the power is turned on, regardless of whether open phase is occurring or the device is running or not, it is very dangerous because the capacitor in the inverter is charged at high voltage for a certain period even after the power is shut off.



Do

- When performing work such as changing wiring after shutting off the power, wait for 10 minutes (\*1) or 15 minutes (\*2), and check that there is no residual voltage between P and N using a tester or other instrument to confirm safety.

\*1) For models P1-00044-L - P1-01240-L (P1-004L - P1-220L) and P1-00041-H - 00620-H (P1-007H - P1-220H)

\*2) For models P1-01530-L - P1-02950-L (P1-300L - P1-550L) and P1-00770-H - P1-03160-H (P1-300H - P1-1320H)

■ Input terminal for main power supply (R,S,T)



Do

- For connection between the power supply and main power terminals (R, S, T), use the earth-leakage breaker for protecting the circuit (wiring).



Prohibited

- This device is compatible with 3-phase power supplies. It cannot be used with single-phase power supplies. If single-phase input is required, please contact our sales office.



Do

- If the protective function of the inverter is activated, it means a failure or an accident is occurring on your system. Connect the magnetic contactor that shuts off power supplied to the inverter.



Prohibited



Electric shock Injury Failure

- Do not operate the inverter when an input phase is lost. Otherwise, you run the risk of damage to the inverter.
- The internal capacitor is charged even when an input phase is lost. You run the risk of electric shock and injury.
- When shipped from the factory, the protective function for input phase loss is disabled, and the following conditions are applied.
  - R-phase or T-phase is lacking:
    - The inverter does not run.
  - S-phase is lacking:
    - It triggers single phase operation, which may cause insufficient voltage, frequent occurrence of overcurrent errors, and the inverter may be burned.



Do

- Since the earth-leakage breaker may malfunction due to effects of high frequency, please use a model with large high-frequency sensitive current value.



Failure



Prohibited

- Do not turn on or off the magnetic contactor installed on the input (primary) and output (secondary) sides of the inverter to start or stop operation. Otherwise, you run the risk of damage to the inverter.



Do

- To start or stop operation using an external signal, use the operation command (FW, RV) of the control circuit terminal block.

■ Input terminal for main power supply (R,S,T)  
(continued)

 Failure

- Do not use a power supply that is applicable to the following conditions. Otherwise, the internal converter module may be burned.

 Prohibited

1. Unbalance of power supply voltage 3% or above.
2. The power supply capacity is 10 times or more the appropriate capacity of ND rating motor and it is not less than 500kVA.
3. If a rapid change of power supply is made to power.  
(Example 1) If more than one inverters are installed and connected with each other by a short bus.  
(Example 2) If a phase leading capacitor is inserted or shut off.

 Failure

- Do not turn on and off the power frequently, which should not do more than once every 3 minutes.

 Prohibited

■ Inverter output terminal (U,V,W)

 DANGER

- Perform wiring only with wires whose thickness is equivalent to or above that of the applicable wires. Otherwise, the output voltage may drop between the inverter and motor. Especially during output at low speed, voltage drop caused by wiring reduces the torque of motor.

 Do

 Failure

- Do not attach a phase leading capacitor or surge absorber, because they may cause inverter errors or damage the capacitor or surge absorber.

 Prohibited

 Failure

- When you connect more than one motors, install a thermal relay for each of them.

 Do

 Burnout

- If the wire length exceeds 20m, due to stray capacity or inductance of the wire, surge voltage may be generated on the motor terminal (especially on 400V class), which may burn the motor.

 Do

- We have a special filter for suppressing surge voltage. Please contact our sales office.

 Failure

- Set the RC value of the thermal relay to be 1.1 times the rated current of motor. The thermal relay may trip earlier than intended depending on the wire length. In such a case, attach an AC reactor on the output side of inverter.

 Do



- \* For compliance with CE standards and UL standards, check "1.6 Compliance with European Directive (CE)" and "1.7 Compliance with UL Standards".
- \* If export to the U.S. or Canada or compliance with UL/cUL standards is required, you need to use wires and breakers specified in the UL/cUL standards. When connecting wires to the main circuit terminal block, use a round crimping terminal (UL-certified item) suitable for the wires for use. Use a crimp tool recommended by the manufacturer of the crimping terminal to crimp the terminal.
- \* The screw size may differ depending on the terminal. For the terminal screw size of the power line, see "7.5.4 Recommended Wire Diameter, Wiring Tools, and Crimping Terminals. For others, see figures in "7.5.6 Wiring Locations".

- \* For wiring to the inverter, crimping terminal, and tightening torque of terminal screws, see tables in "7.5.4 Recommended Wire Diameter, Wiring Tools, and Crimping Terminals.
- \* The recommended wire diameter and amplifier size vary depending on the settings of load rating (ND/LD/VLD).
- \* The wire diameters shown in tables in "7.5.4 Recommended Wire Diameter, Wiring Tools, and Crimping Terminals" indicate design values for HIV wire (resistant to 75° C heat).
- \* When connecting wires to the main circuit terminal block, use a round crimping terminal in accordance with the wires for use. Use a crimp tool recommended by the manufacturer of the crimping terminal to crimp the terminal.
- \* When replacing SJ700 with this device, for different wire diameter, etc., please contact the customer communication center described in the back cover.

### 7.5.4 Recommended Wire Diameter, Wiring Tools, and Crimping Terminals

■ 200V class

P1 model P1-***** (P1-****)	Rated settings	Power line AWG (mm <sup>2</sup> ) R,S,T,U,V,W,P,P D,N	Ground line AWG (mm <sup>2</sup> )	Braking resistor AWG between P and RB (mm <sup>2</sup> )	Screw size of power line terminal	Crimping terminal power line/ground line	Tightening torque N·m	
P1-00044-L (P1-004L)	ND	14(2.1)	14(2.1)	14(2.1)	M4	2-4/2-4	1.4	
	LD							
	VLD							
P1-00080-L (P1-007L)	ND	14(2.1)	14(2.1)	14(2.1)	M4	2-4/2-4	1.4	
	LD							
	VLD							
P1-00104-L (P1-015L)	ND	14(2.1)	14(2.1)	14(2.1)	M4	2-4/2-4	1.4	
	LD							
	VLD							
P1-00156-L (P1-022L)	ND	14(2.1)	14(2.1)	14(2.1)	M4	2-4/2-4	1.4	
	LD					5.5-4/5.5-4		
	VLD	10(5.3)	10(5.3)	10(5.3)				
P1-00228-L (P1-037L)	ND	10(5.3)	10(5.3)	10(5.3)	M4	5.5-4/5.5-4	1.4	
	LD							
	VLD							
P1-00330-L (P1-055L)	ND	8(8.4)	8(8.4)	8(8.4)	M5	8-5/8-5	3.0	
	LD							
	VLD							
P1-00460-L (P1-075L)	ND	8(8.4)	6(13.3)	8(8.4)	M5	8-5/8-5	3.0	
	LD					14-5/8-5		
	VLD	6(13.3)	6(13.3)	6(13.3)				
P1-00600-L (P1-110L)	ND	6(13.3)	6(13.3)	6(13.3)	M6	14-6/14-6	4.0	
	LD	4(21.2)		4(21.2)		22-6/14-6		
	VLD			4(21.2)		4(21.2)		22-6/14-6
P1-00800-L (P1-150L)	ND	4(21.2)	6(13.3)	4(21.2)	M6	22-6/14-6	2.5~3.0	
	LD	3(26.7)		3(26.7)		3(26.7)		38-6/14-6
	VLD							
P1-00930-L (P1-185L)	ND	3(26.7)	6(13.3)	3(26.7)	M6	38-6/14-6	2.5~3.0	
	LD	2(33.6)		2(33.6)				2(33.6)
	VLD	1(42.4)		1(42.4)				1(42.4)
P1-01240-L (P1-220L)	ND	1(42.4)	6(13.3)	1(42.4)	M8	60-8/14-6	5.5~6.6	
	LD	1/0(53.5)		1/0(53.5)		1/0(53.5)		
	VLD	2/0(67.4)		2/0(67.4)		2/0(67.4)		
P1-01530-L (P1-300L)	ND	2/0(67.4)	4(21.2)	-	M8	70-8/22-6	6.0	
	LD	1/0×2(53.5×2)				60-8/22-6		
	VLD							
P1-01850-L (P1-370L)	ND	4/0(107.2)	4(21.2)	-	M8	100-8/22-8	15.0	
	LD	1/0×2(53.5×2)				60-8/22-8		
	VLD							
P1-02290-L (P1-450L)	ND	1/0×2(53.5×2)	4(21.2)	-	M8	60-8/22-8	6.0~10.0	
	LD	2/0×2(67.4×2)				70-8/22-8		
	VLD							
P1-02950-L (P1-550L)	ND	350kc(177)	3(26.7)	-	M10	180-10/38-8	19.6	
	LD	3/0×2(85.0×2)				80-10/38-8		
	VLD							



## ■ 400V class

P1 model P1-***** (P1-****)	Rated settings	Power line AWG (mm <sup>2</sup> ) R,S,T,U,V,W,P,P D,N	Ground line AWG (mm <sup>2</sup> )	Braking resistor AWG between P and RB (mm <sup>2</sup> )	Screw size of power line terminal	Crimping terminal power line/ground line	Tightening torque N·m
P1-00041-H (P1-007H)	ND	14(2.1)	14(2.1)	14(2.1)	M4	2-4/2-4	1.4
	LD						
	VLD						
P1-00054-H (P1-015H)	ND	14(2.1)	14(2.1)	14(2.1)	M4	2-4/2-4	1.4
	LD						
	VLD						
P1-00083-H (P1-022H)	ND	14(2.1)	14(2.1)	14(2.1)	M4	2-4/2-4	1.4
	LD						
	VLD						
P1-00126-H (P1-037H)	ND	14(2.1)	14(2.1)	14(2.1)	M4	2-4/2-4	1.4
	LD					5.5-4/5.5-4	
	VLD					12(3.3)	
P1-00175-H (P1-055H)	ND	12(3.3)	12(3.3)	12(3.3)	M5	5.5-5/5.5-5	3.0
	LD						
	VLD						
P1-00250-H (P1-075H)	ND	10(5.3)	10(5.3)	10(5.3)	M5	5.5-5/5.5-5	3.0
	LD					8-5/8-5	
	VLD					8(8.4)	
P1-00310-H (P1-110H)	ND	8(8.4)	8(8.4)	8(8.4)	M6	8-6/8-6	4.0
	LD						
	VLD						
P1-00400-H (P1-150H)	ND	8(8.4)	8(8.4)	8(8.4)	M6	8-6/8-6	4.0
	LD						
	VLD						
P1-00470-H (P1-185H)	ND	8(8.4)	8(8.4)	8(8.4)	M6	8-6/8-6	4.0
	LD			6(13.3)		14-6/8-6	
	VLD			6(13.3)		14-6/8-6	
P1-00620-H (P1-220H)	ND	6(13.3)	8(8.4)	6(13.3)	M6	14-6/8-6	4.0
	LD			4(21.2)		22-6/8-6	
	VLD			4(21.2)		22-6/8-6	
P1-00770-H (P1-300H)	ND	3(26.7)	6(13.3)	-	M8	38-8/14-6	6.0
	LD	2(33.6)				60-8/14-6	
	VLD	1(42.4)				60-8/14-6	
P1-00930-H (P1-370H)	ND	1(42.4)	6(13.3)	-	M8	60-8/14-8	15.0
	LD						
	VLD						
P1-01160-H (P1-450H)	ND	1(42.4)	6(13.3)	-	M8	60-8/14-8	6.0~10.0
	LD	1/0(53.5)				70-8/14-8	
	VLD	2/0(67.4)				70-8/22-8	
P1-01800-H (P1-550H)	ND	2/0(67.4)	4(21.2)	-	M8	70-8/22-8	6.0~10.0
	LD	1/0×2(53.5×2)				60-8/22-8	
	VLD	1/0×2(53.5×2)				60-8/22-8	
P1-02160-H (P1-750H)	ND	(Please contact us)					
	LD						
	VLD						
P1-02600-H (P1-900H)	ND	(Please contact us)					
	LD						
	VLD						
P1-03250-H (P1-1100H)	ND	(Please contact us)					
	LD						
	VLD						
P1-03610-H (P1-1320H)	ND	(Please contact us)					
	LD						
	VLD						

## 7.5.5 Applicable Breakers

### 200V class

• When inverter ND rating setting

P1 model P1-***** (P1-****)	Applicable motor (kW)	Applicable instrument (input voltage 200-220V)							
		Without power factor improvement reactor (DCL or ACL)				With power factor improvement reactor (DCL or ACL)			
		Earth-leakage breaker (ELB)		Magnetic contactor (MC)		Earth-leakage breaker (ELB)		Magnetic contactor (MC)	
Example of model	Rated current	AC-1	AC-3	Example of model	Rated current	AC-1	AC-3		
P1-00044-L(P1-004L)	0.4	EB-30E	5	HS8	HS8	EB-30E	5	HS8	HS8
P1-00080-L(P1-007L)	0.75	EB-30E	10	HS8	HS8	EB-30E	5	HS8	HS8
P1-00104-L(P1-015L)	1.5	EB-30E	15	HS8	HS8	EB-30E	10	HS8	HS8
P1-00156-L(P1-022L)	2.2	EB-30E	20	HS8	HS8	EB-30E	15	HS8	HS8
P1-00228-L(P1-037L)	3.7	EB-30E	30	HS8	HS20	EB-30E	20	HS8	HS20
P1-00330-L(P1-055L)	5.5	EB-50E	40	HS20	HS25	EB-30E	30	HS8	HS20
P1-00460-L(P1-075L)	7.5	EB-50E	50	HS35	HS35	EB-50E	40	HS20	HS25
P1-00600-L(P1-110L)	11	EB-100E	75	HS50	H65C	EB-100E	60	HS35	HS50
P1-00800-L(P1-150L)	15	RXK125-S	125	H65C	H80C	EB-100E	100	HS50	H65C
P1-00930-L(P1-185L)	18.5	RXK125-S	125	H80C	H100C	EB-100E	100	HS50	H65C
P1-01240-L(P1-220L)	22	EXK225	150	H80C	H125C	RXK125-S	125	H65C	H80C
P1-01530-L(P1-300L)	30	EXK225	200	H125C	H150C	EXK225	150	H80C	H125C
P1-01850-L(P1-370L)	37	RXK250-S	250	H150C	H200C	EXK225	200	H100C	H125C
P1-02290-L(P1-450L)	45	EX400	300	H200C	H250C	EXK225	225	H125C	H150C
P1-02950-L(P1-550L)	55	EX400	400	H200C	H300C	EX400	300	H150C	H250C

- When inverter LD/VLD rating setting

P1 model P1-***** (P1-****)	Applicable motor (kW)	Applicable instrument (input voltage 200-220V)							
		Without power factor improvement reactor (DCL or ACL)				With power factor improvement reactor (DCL or ACL)			
		Earth-leakage breaker (ELB)		Magnetic contactor (MC)		Earth-leakage breaker (ELB)		Magnetic contactor (MC)	
Example of model	Rated current	AC-1	AC-3	Example of model	Rated current	AC-1	AC-3		
P1-00044-L(P1-004L)	0.75	EB-30E	10	HS8	HS8	EB-30E	5	HS8	HS8
P1-00080-L(P1-007L)	1.5	EB-30E	15	HS8	HS8	EB-30E	10	HS8	HS8
P1-00104-L(P1-015L)	2.2	EB-30E	20	HS8	HS8	EB-30E	15	HS8	HS8
P1-00156-L(P1-022L)	3.7	EB-30E	30	HS8	HS20	EB-30E	20	HS8	HS20
P1-00228-L(P1-037L)	5.5	EB-50E	40	HS20	HS25	EB-30E	30	HS8	HS20
P1-00330-L(P1-055L)	7.5	EB-50E	50	HS35	HS35	EB-50E	40	HS20	HS25
P1-00460-L(P1-075L)	11	EB-100E	75	HS50	H65C	EB-100E	60	HS35	HS50
P1-00600-L(P1-110L)	15	RXK125-S	125	H65C	H80C	EB-100E	100	HS50	H65C
P1-00800-L(P1-150L)	18.5	RXK125-S	125	H80C	H100C	EB-100E	100	HS50	H65C
P1-00930-L(P1-185L)	22	EXK225	150	H80C	H125C	RXK125-S	125	H65C	H80C
P1-01240-L(P1-220L)	30	EXK225	200	H125C	H150C	EXK225	150	H80C	H125C
P1-01530-L(P1-300L)	37	RXK250-S	250	H150C	H200C	EXK225	200	H100C	H125C
P1-01850-L(P1-370L)	45	EX400	300	H200C	H250C	EXK225	225	H125C	H150C
P1-02290-L(P1-450L)	55	EX400	400	H200C	H300C	EX400	300	H150C	H250C
P1-02950-L(P1-550L)	75	EX600B	500	H300C	H400C	EX400	400	H200C	H300C

\* If export to the U.S. or Canada or compliance with UL/cUL standards is required, you need to use wires and breakers specified in the UL/cUL standards. For details, see "1.7 Compliance with UL Standards".

\* The models described in the table are examples of selection. When using the device, choose a model that has appropriate breaking capacity and sensitive current by taking short circuit current and relevant laws and regulations into consideration based on the rated current shown in the table.

\* The applicable motor capacity is a selection example when Hitachi IE3 4-pole motor model 60HZ 200VAC (200V class) is used.

\* For the power line diameter, see the "Power line" column in the table shown in "7.5.4 Recommended Wire Diameter, Wiring Tools, and Crimping Terminals".

\* The electric durability ensured when the magnetic contactor is used in AC-1 class is 500,000 times, while emergency stop during motor operation is 25 times.

\* If there is emergency stop during motor drive or commercial operation is performed, choose the magnetic contactor on the motor side in AC-3 class against the rated current of motor.

\* If the rated capacity of inverter is larger than the motor capacity, choose instruments based on the inverter model.

■ 400V class

• At inverter ND rating setting

P1 model P1-***** (P1-****)	Applicable motor (kW)	Applicable instrument (input voltage 400-440V)							
		Without power factor improvement reactor (DCL or ACL)				With power factor improvement reactor (DCL or ACL)			
		Earth-leakage breaker (ELB)		Magnetic contactor (MC)		Earth-leakage breaker (ELB)		Magnetic contactor (MC)	
		Example of model	Rated current	AC-1	AC-3	Example of model	Rated current	AC-1	AC-3
P1-00041-H(P1-007H)	0.75	EX50C	5	HS8	HS8	EX50C	5	HS8	HS8
P1-00054-H(P1-015H)	1.5	EX50C	10	HS8	HS8	EX50C	5	HS8	HS8
P1-00083-H(P1-022H)	2.2	EX50C	10	HS8	HS8	EX50C	10	HS8	HS8
P1-00126-H(P1-037H)	3.7	EXK50-C	15	HS8	HS10	EX50C	10	HS8	HS10
P1-00175-H(P1-055H)	5.5	EXK50-C	20	HS8	HS20	EXK50-C	15	HS8	HS20
P1-00250-H(P1-075H)	7.5	EXK50-C	30	HS8	HS25	EXK50-C	20	HS20	HS25
P1-00310-H(P1-110H)	11	EXK50-C	40	HS20	HS35	EXK50-C	30	HS25	HS35
P1-00400-H(P1-150H)	15	EXK50-C	50	HS25	HS50	EXK50-C	40	HS35	HS50
P1-00470-H(P1-185H)	18.5	EXK100-C	75	HS35	HS50	EXK50-C	50	HS50	HS50
P1-00620-H(P1-220H)	22	EXK100-C	75	HS50	H65C	EXK60-C	60	HS50	H65C
P1-00770-H(P1-300H)	30	EXK100-C	100	HS50	H80C	EXK100-C	75	H80C	H80C
P1-00930-H(P1-370H)	37	RXK125-S	125	H80C	H100C	EXK100-C	100	H80C	H100C
P1-01160-H(P1-450H)	45	EXK225	150	H80C	H125C	RXK125-S	125	H100C	H125C
P1-01470-H(P1-550H)	55	EXK225	200	H100C	H125C	EXK225	150	H150C	H125C
P1-01760-H(P1-750H)	75	RXK250-S	250	H150C	H200C	EXK225	200	H200C	H200C
P1-02130-H(P1-900H)	90	EX400	300	H200C	H250C	EXK225	225	H200C	H250C
P1-02520-H(P1-1100H)	110	EX400	400	H200C	H300C	EX400	300	H250C	H300C
P1-03160-H(P1-1320H)	132	EX600B	500	H250C	H300C	EX400	350	H400C	H400C

• At inverter LD/VLD rating setting

P1 model P1-***** (P1-****)	Applicable motor (kW)	Applicable instrument (input voltage 400-440V)							
		Without power factor improvement reactor (DCL or ACL)				With power factor improvement reactor (DCL or ACL)			
		Earth-leakage breaker (ELB)		Magnetic contactor (MC)		Earth-leakage breaker (ELB)		Magnetic contactor (MC)	
		Example of model	Rated current	AC-1	AC-3	Example of model	Rated current	AC-1	AC-3
P1-00041-H(P1-007H)	1.5	EX50C	10	HS8	HS8	EX50C	5	HS8	HS8
P1-00054-H(P1-015H)	2.2	EX50C	10	HS8	HS8	EX50C	10	HS8	HS8
P1-00083-H(P1-022H)	3.7	EXK50-C	15	HS8	HS10	EX50C	10	HS8	HS8
P1-00126-H(P1-037H)	5.5	EXK50-C	20	HS8	HS20	EXK50-C	15	HS8	HS20
P1-00175-H(P1-055H)	7.5	EXK50-C	30	HS8	HS25	EXK50-C	20	HS8	HS20
P1-00250-H(P1-075H)	11	EXK50-C	40	HS20	HS35	EXK50-C	30	HS8	HS25
P1-00310-H(P1-110H)	15	EXK50-C	50	HS25	HS50	EXK50-C	40	HS20	HS35
P1-00400-H(P1-150H)	18.5	EXK100-C	75	HS35	HS50	EXK50-C	50	HS20	HS35
P1-00470-H(P1-185H)	22	EXK100-C	75	HS50	H65C	EXK60-C	60	HS35	HS50
P1-00620-H(P1-220H)	30	EXK100-C	100	HS50	H80C	EXK100-C	75	HS50	H65C
P1-00770-H(P1-300H)	37	RXK125-S	125	H80C	H100C	EXK100-C	100	HS50	H65C
P1-00930-H(P1-370H)	45	EXK225	150	H80C	H125C	RXK125-S	125	H65C	H80C
P1-01160-H(P1-450H)	55	EXK225	200	H100C	H125C	EXK225	150	H80C	H100C
P1-01470-H(P1-550H)	75	EX400	250	H150C	H200C	EXK225	200	H100C	H125C
P1-01760-H(P1-750H)	90	EX400	300	H200C	H250C	EXK225	225	H125C	H150C
P1-02130-H(P1-900H)	110	EX400	400	H200C	H300C	EX400	300	H150C	H250C
P1-02520-H(P1-1100H)	132	EX600B	500	H250C	H300C	EX400	350	H200C	H250C
P1-03160-H(P1-1320H)	160	EX600B	600	H400C	H400C	EX400	400	H250C	H300C

- \* If export to the U.S. or Canada or compliance with UL/cUL standards is required, you need to use wires and breakers specified in the UL/cUL standards. For details, see "1.7 Compliance with UL Standards".
- \* The models described in the table are examples of selection. When using the device, choose a model that has appropriate breaking capacity and sensitive current by taking short circuit current and relevant laws and regulations into consideration based on the rated current shown in the table.
- \* The applicable motor capacity is a selection example when Hitachi IE3 4-pole motor model of 60HZ 400VAC (400V class) is used.
- \* For the power line diameter, see the "Power line" column in the table shown in "7.5.4 Recommended Wire Diameter, Wiring Tools, and Crimping Terminals".

- \* The electric durability ensured when the magnetic contactor is used in AC-1 class is 500,000 times, while emergency stop during motor operation is 25 times.
- \* If there is emergency stop during motor drive or commercial operation is performed, choose the magnetic contactor on the motor side in AC-3 class against the rated current of motor.
- \* If the rated capacity of inverter is larger than the motor capacity, choose instruments based on the inverter model.

7.5.6 Wiring Locations



- The charge lamp indicates input of power to R, S, and T. At the factory default setting, power is supplied to R0 and T0 via the J51 connector.
- When the J51 connector is removed and power is supplied to R0 and T0 from another source, the charge lamp does not indicate energization status of R0 and T0. Make sure that the power is shut off and safety is ensured before working.
- The charge lamp does not light up also when only 24V is supplied.

**Model P1-\*\*\*\*\*(P1-\*\*\*\*)**

200V class: 00044-L(004L), 00080-L(007L), 00104-L(015L), 00156-L(022L), 00228-L(037L)

400V class: 00041-H(007H), 00054-H(015H), 00083-H(022L), 00126-H(037H)

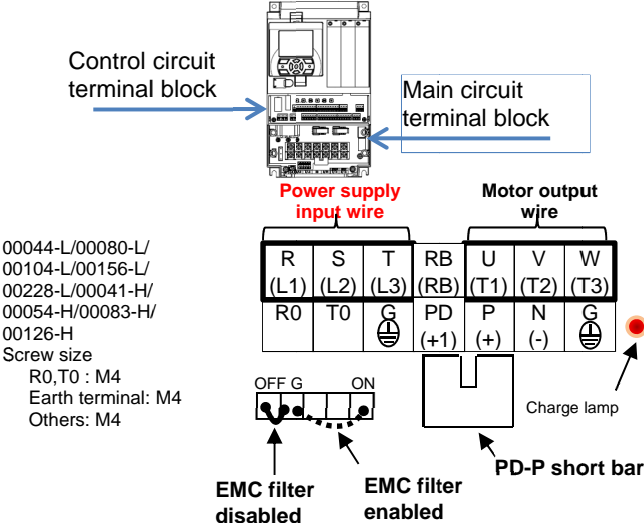

\* The EMC filter is enabled/disabled by switching the short bar connector.

**Model P1-\*\*\*\*\*(P1-\*\*\*\*)**

200V class: 00330-L(055L), 00460-L(075L), 00600-L(110L)

400V class: 00175-H(055H), 00250-H(075H), 00310-H(110H)

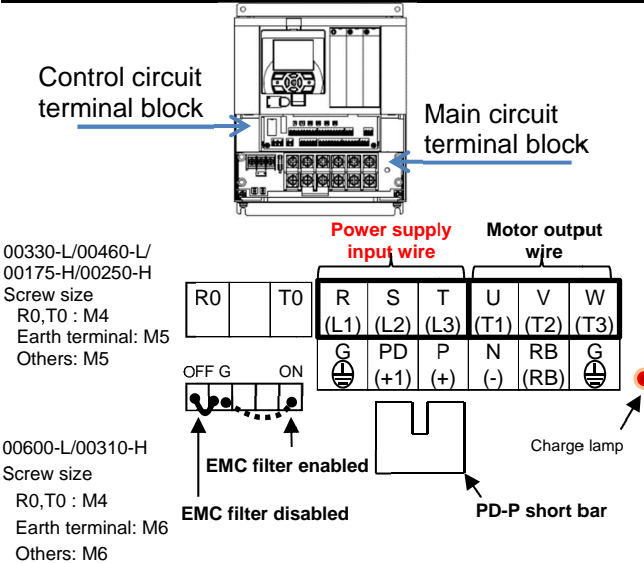

\* The EMC filter is enabled/disabled by switching the short circuit connector.

**Model P1-\*\*\*\*\*(P1-\*\*\*\*)**

200V class: 00800-L(150L), 00930-L(185L), 01240-L(220L)

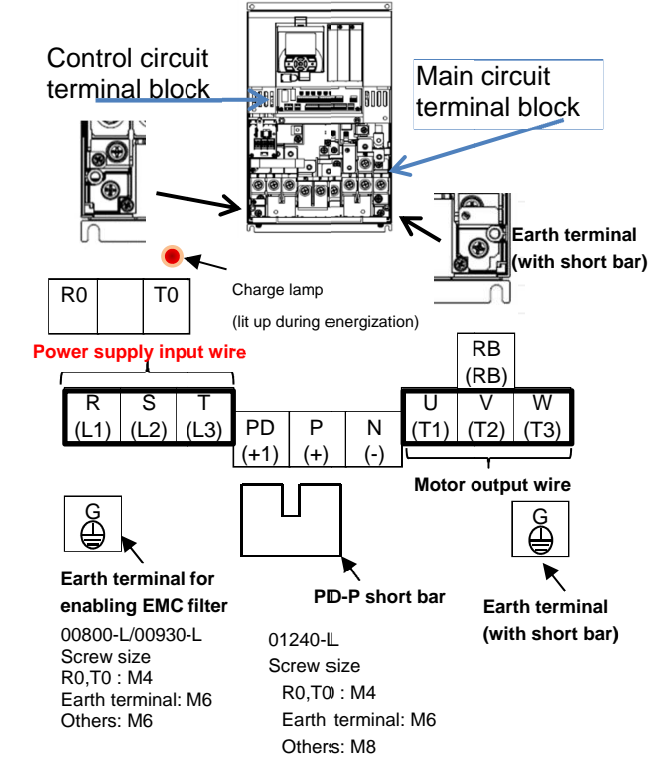

\* The EMC filter is enabled by replacing the grounding screw equipped with short bar with the earth terminal for enabling the EMC filter.

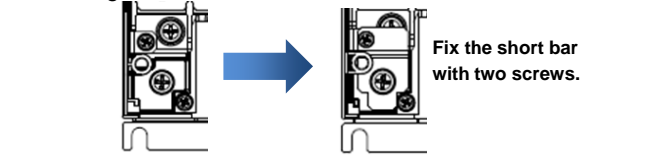

**Model P1-\*\*\*\*\*(P1-\*\*\*\*)**

400V class: 00400-H(150H), 00470-H(185H), 00620-H(220H)

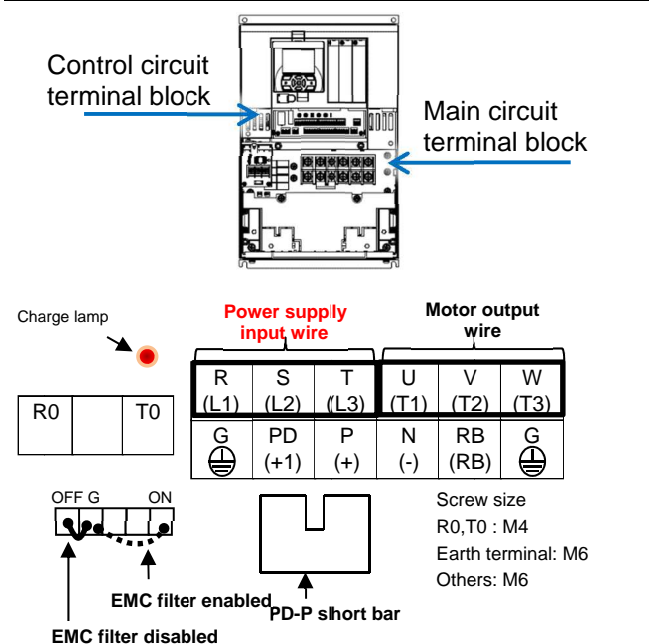

\* The EMC filter is enabled/disabled by switching the short circuit connector.

**Model P1-\*\*\*\*\*-(P1-\*\*\*\*)**  
200V class: 01530-L(300L)

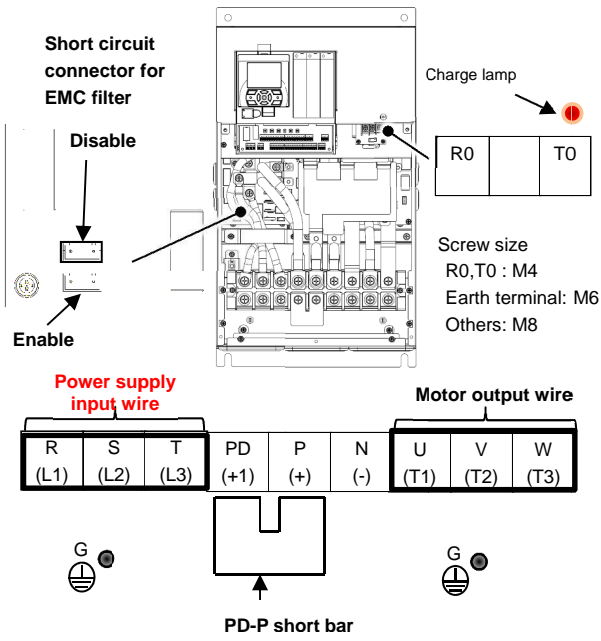

\* The EMC filter is enabled/disabled by switching the short circuit connector.

**Model P1-\*\*\*\*\*-(P1-\*\*\*\*)**  
200V class: 01850-L(370L)

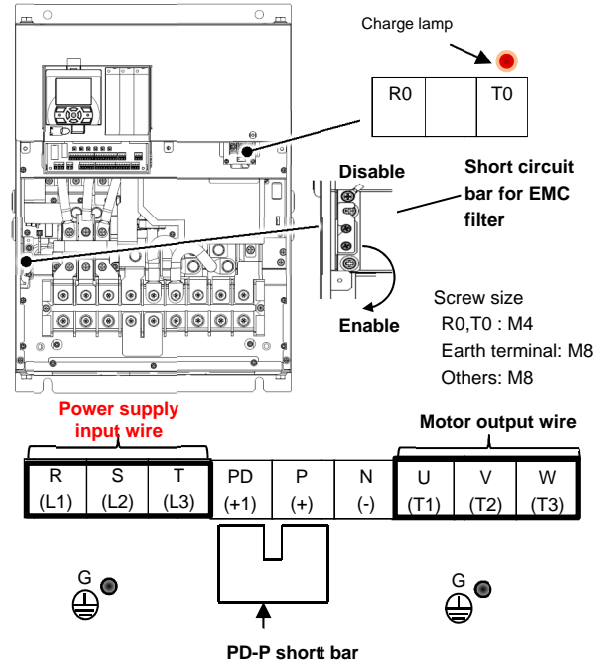

\* The EMC filter is enabled/disabled by switching the short circuit bar.

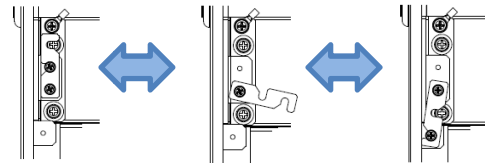

**Model P1-\*\*\*\*\*-(P1-\*\*\*\*)**  
400V class: 00770-H(300H)

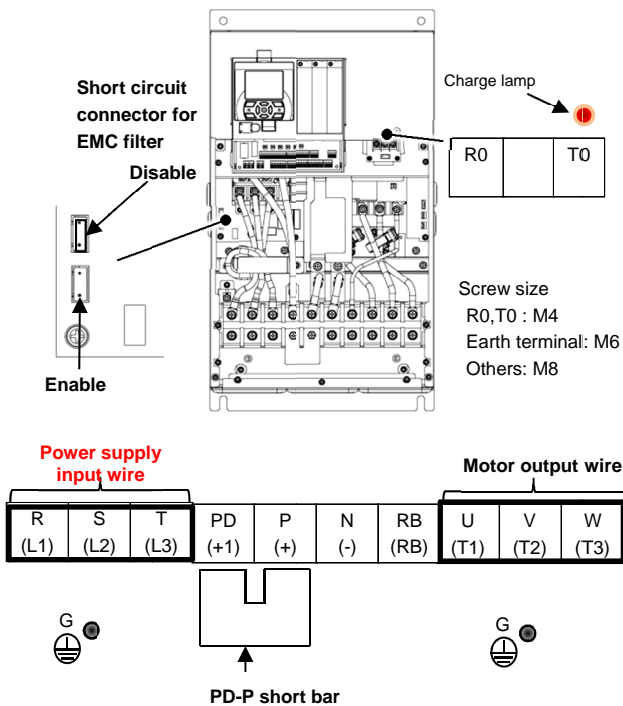

\* The EMC filter is enabled/disabled by switching the short circuit connector.

**Model P1-\*\*\*\*\*-(P1-\*\*\*\*)**  
400V class: 00930-H(370H)

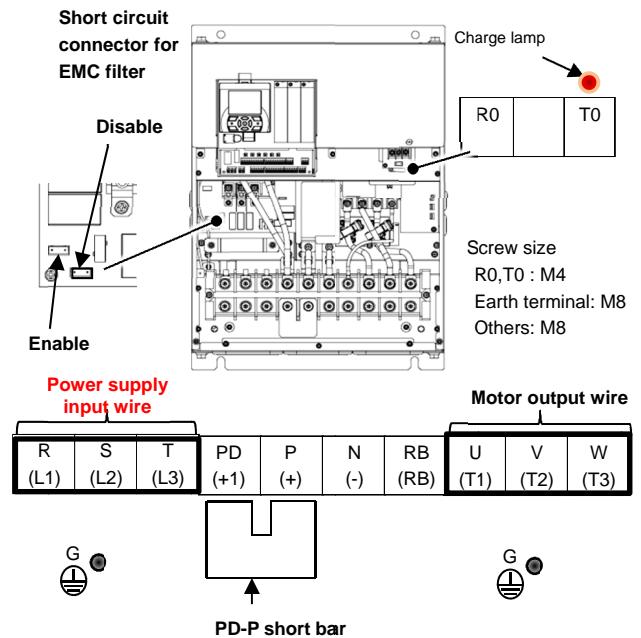

\* The EMC filter is enabled/disabled by switching the short circuit connector.

**Model P1-\*\*\*\*\*(P1-\*\*\*\*)**  
200V class: 02290-L(450L)

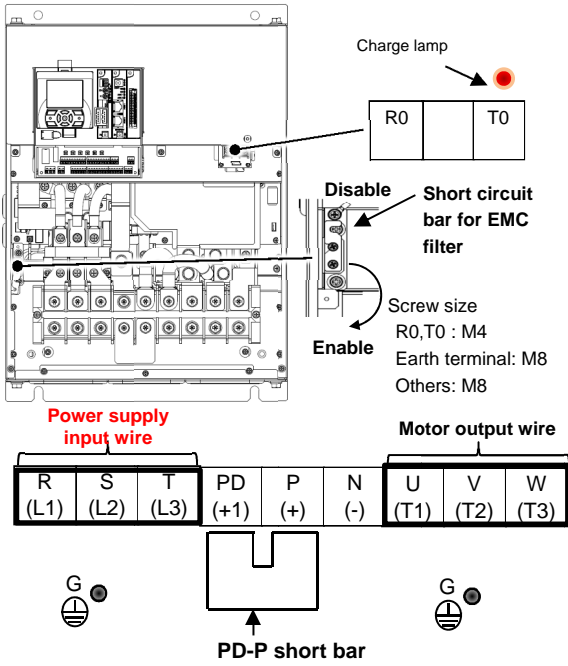

\* For the switching method of EMC filter, see the lower left section of this page.

**Model P1-\*\*\*\*\*(P1-\*\*\*\*)**  
200V class: 02950-L(550L)

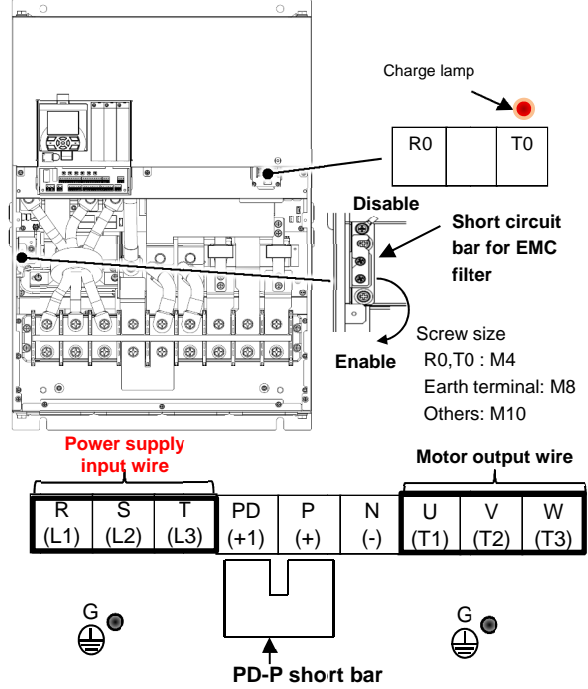

\* For the switching method of EMC filter, see the lower left section of this page.

**Model P1-\*\*\*\*\*(P1-\*\*\*\*)**  
400V class:01160-H(450H)

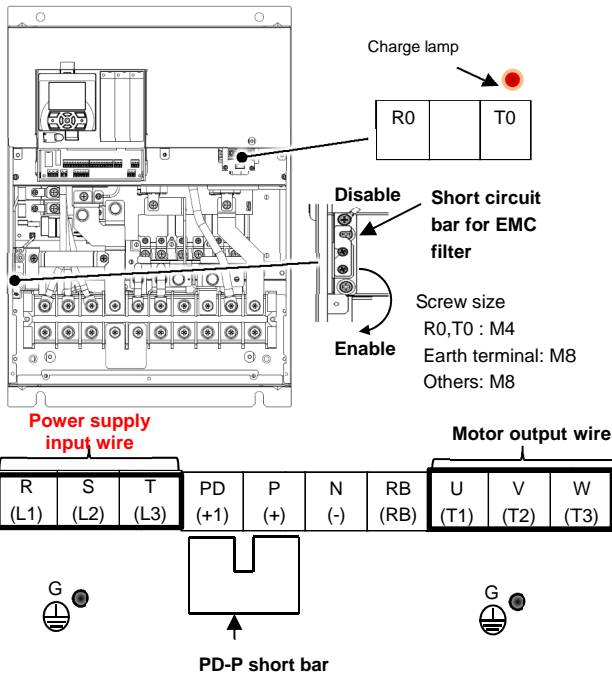

\* For the switching method of EMC filter, see the lower left section of this page.

• Switching method of EMC filter  
The EMC filter is enabled/disabled by switching the short circuit bar.

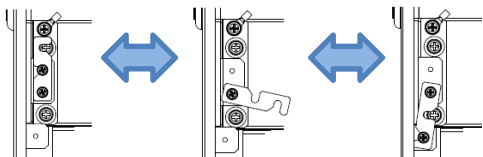

**Model P1-\*\*\*\*\*(P1-\*\*\*\*)**  
400V class:01470-H(550H)

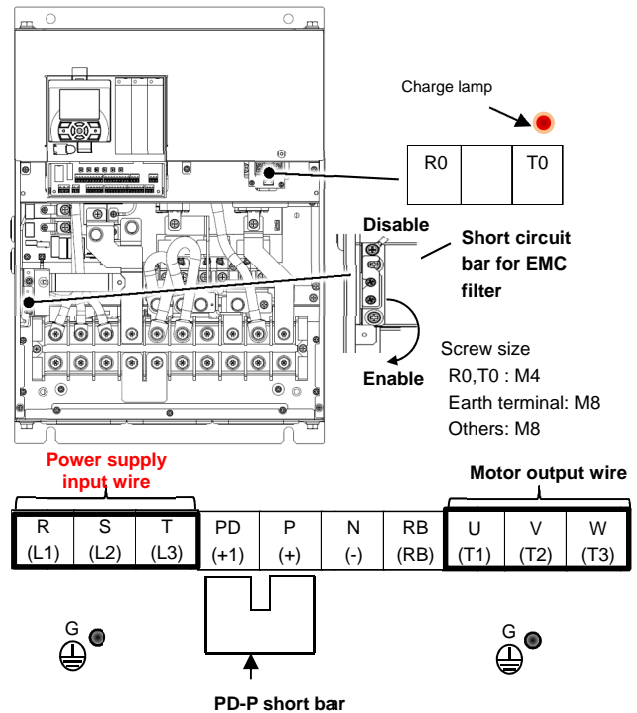

\* For the switching method of EMC filter, see the lower left section of this page.

**Model (P1-\*\*\*\*\*)**  
400V class:01760-H(750H)

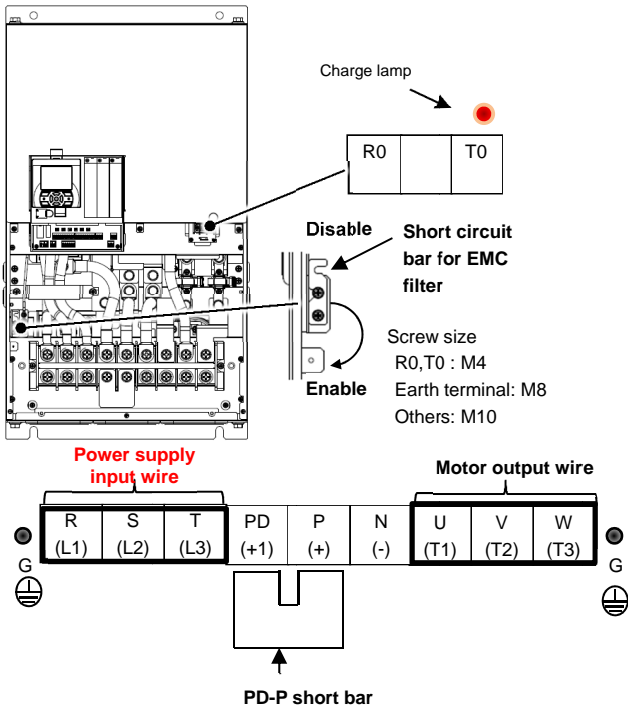

\* For the switching method of EMC filter, see the lower left section of this page.

**Model (P1-\*\*\*\*\*)**  
400V class:02130-H(900H)

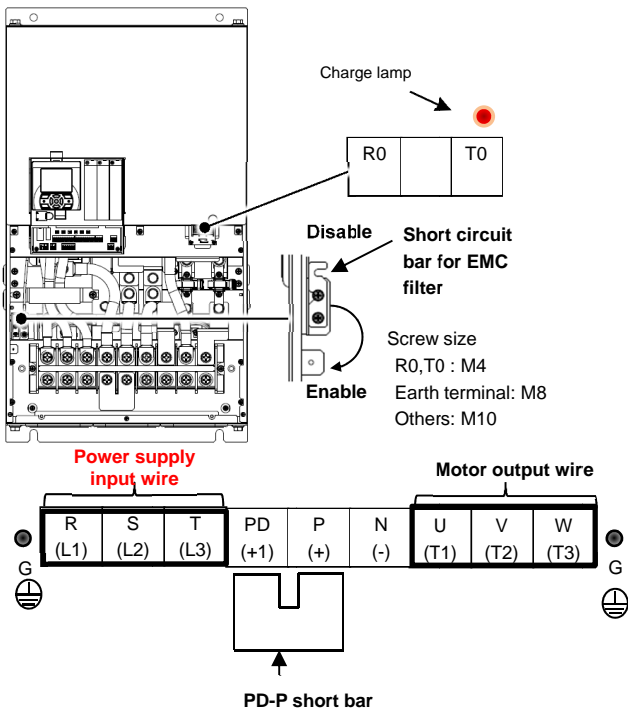

\* For the switching method of EMC filter, see the lower left section of this page.

• Switching method of EMC filter  
The EMC filter is enabled/disabled by switching the short circuit bar.

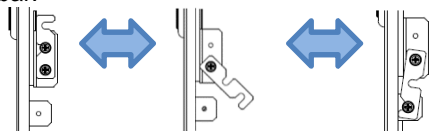

**Model (P1-\*\*\*\*\*)**  
400V class:02520-H(1100H)

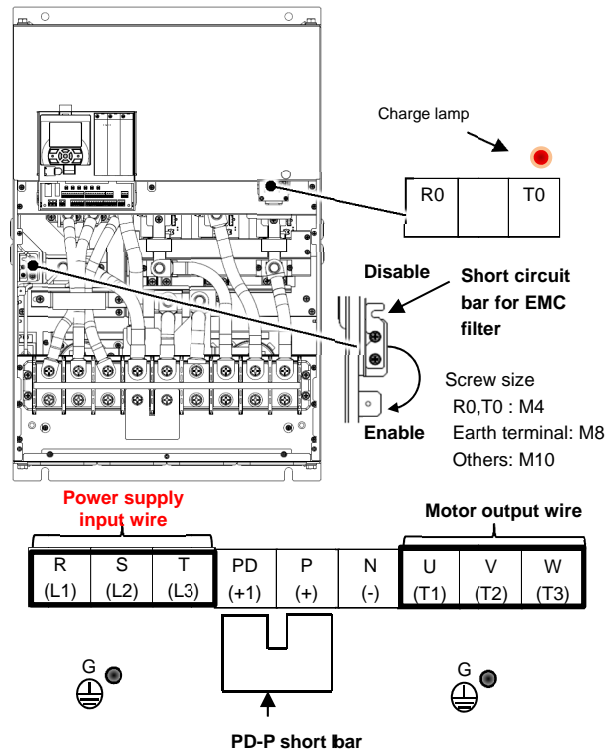

\* For the switching method of EMC filter, see the lower left section of this page.

**Model (P1-\*\*\*\*\*)**  
400V class:03160-H(1320H)

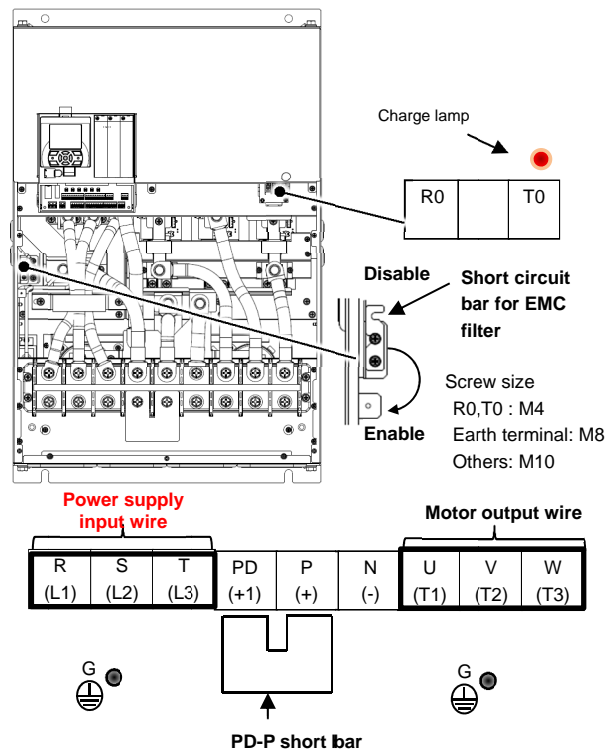

\* For the switching method of EMC filter, see the lower left section of this page.

\* For models not described in this document, please contact the customer communication center shown in the back cover.

7.5.7 Wiring to Power Supply and Motor

Q

- We want to connect a power supply to the inverter.
- We want to connect a motor to the inverter.

A

- Connect R, S, T (L1, L2, L4) to the AC power supply.
- Connect U, V, W (T1, T2, T3) to the motor.
- The common wiring examples are shown below.



• Use the input power supply within the range shown below.

Voltage class	Input range
200V class	200-240VAC (allowable variation range: +10%/-15%) Power supply frequency: 50Hz/60Hz (variation range: ±5%)
400V class	380-500VAC (allowable variation range: +10%/-15%) Power supply frequency: 50Hz/60Hz (variation range: ±5%)



• Driving a 200V motor using a 400V-class inverter may burn the motor.

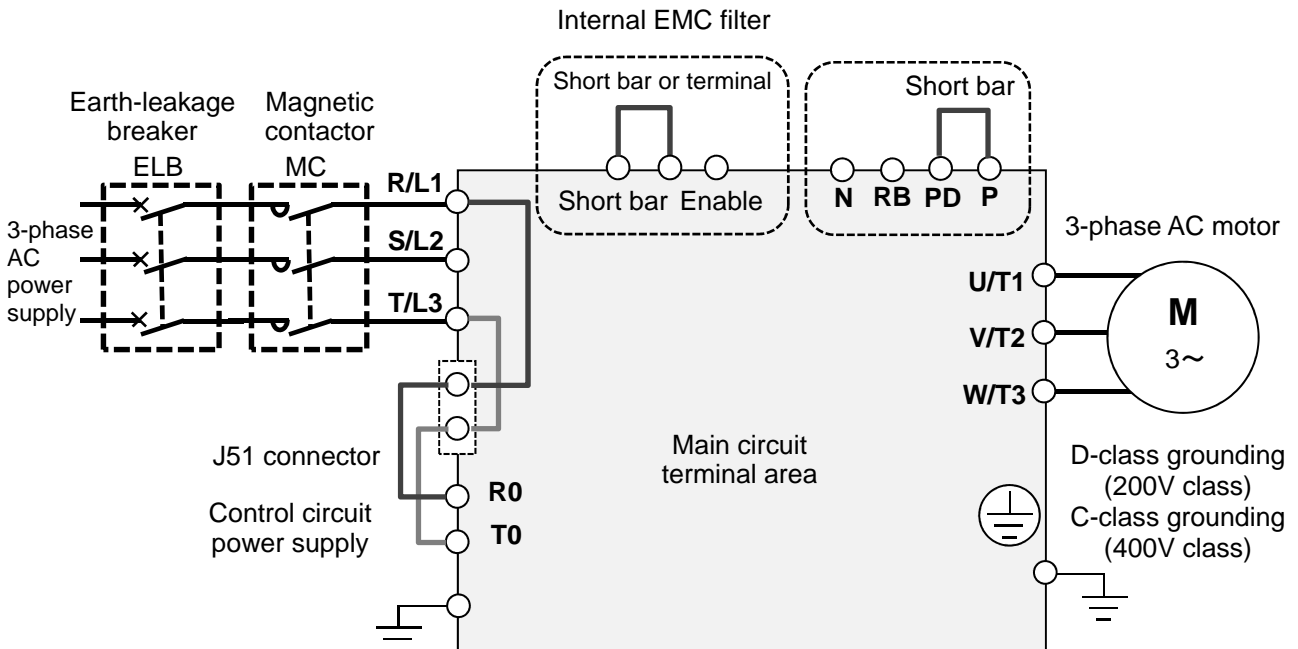



**7.5.8** Wiring Separately to the Control Circuit Power Supply



- We want to use a separate power supply for the control circuit.
- We want to retain the alarm signal even when the protection circuit of the inverter operates and shuts off the magnetic contactor on the input source of inverter.



- When the protection circuit of the inverter operates and shuts off the magnetic contactor on the input source of inverter, there will be no power supply that controls the inverter, and the alarm signal of the output terminal function [AL] cannot be retained. To retain the alarm signal, use the control circuit power supply R0 and T0.



- By the following procedure, connect the terminals for control circuit power supply R0 and T0 to the primary side of the magnetic contactor.
- Loosen the screws and remove the wires connected to R0 and T0.
  - Remove the whole J51 connector.
  - Connect the control circuit power supply to R0 and T0.

- For R0/T0 terminal wire (terminal screw size: M4), use a wire whose diameter is 1.25mm<sup>2</sup> or larger. The recommended tightening torque is 1.2Nm (maximum of 1.4Nm).
- Connect a 3A fuse to the power line for the control circuit.



- To create a separate line for the control circuit power supply, remove the J51 connector and directly connect the power supply (two wires of the main circuit voltage). If there is abnormality on the main circuit area, you can change or read internal data while the main circuit area is turned off.
- By inputting 24V from an external source, you can change or read data only with the input of 24V power supply.



- If you turn on the control circuit power supply R0 and T0 in advance with the main circuit power supply R, S, and T, ground fault detection is performed upon main circuit power-on.
- When connecting a DC power supply to the control circuit power supply R0 and T0, set the output terminal NO/NC selection [CC-11] - [CC-17] to 00. The signal output may chatter when DC power is shut off. Please be careful.

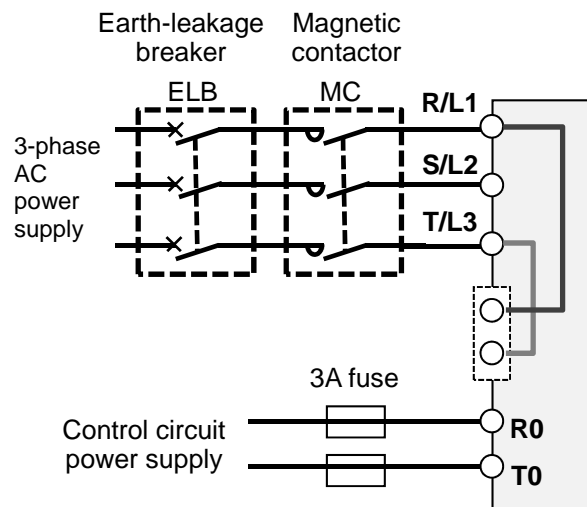

Specification of power receipt on the control circuit power supply

200V class: 200-240VAC (+10%, -15%)  
(50,60Hz±5%)(282-339VDC)

400V class: 380-500VAC (+10%, -15%)  
(50,60Hz±5%)(537-707VDC)

**7.5.9** Outline of Applicable Peripheral Devices

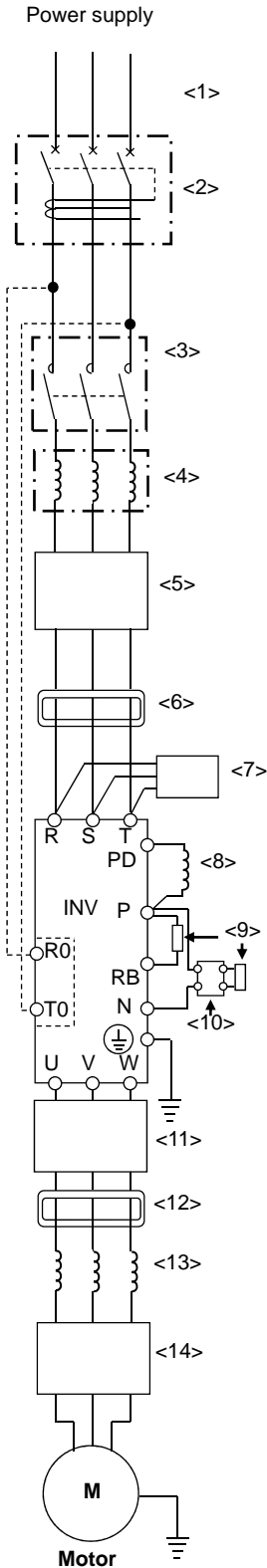

**Cautions**

- The applicable devices shown in this chapter are those when Hitachi standard 3-phase 4-pole cage motor is used.
- For the circuit breaker, choose an appropriate device by taking breaking capacity into consideration.
- (Use an inverter-compatible model.)
- To ensure safety, use an earth-leakage breaker (ELB).
- Use a 75°C copper wire (HIV wire).
- If the wiring length exceeds 20m, a thick power line needs to be used.
- Use an alarm output contact of 0.75 mm<sup>2</sup>.
- Tighten the terminal screws at a specified torque. If they are not tightened enough, it may cause short circuit or fire. If they are tightened too much, it may damage the terminal block or inverter.
- Employ different sensitive currents for earth-leakage breaker (ELB) depending on the total wiring length between the inverter and power supply and between the inverter and motor. Also, use a time-delay type earth-leakage breaker. High-speed type products may malfunction.
- If wiring is performed on a metal tube using CV wire, leak current is about 30mA/km.
- As relative permittivity of IV wire is high, the current increases by about 8 times. Therefore, use an item with 8 times sensitive current that is shown on the table below. If the total wiring length exceeds 100m, use a CV wire.

Total wiring length	Sensitive current (mA)
100m or shorter	50
300m or shorter	100

No.	Name	Function
<1>	Wire	See page 7-9 Recommended Wire Diameter, Wiring Tools, and Crimping Terminals.
<2>	Earth-leakage breaker (ELB)	
<3>	Magnetic contactor (MC)	
<4>	Input side reactor (for harmonic suppression, power coordination, and improvement of power factor)(ALI-□□□□)	This is applied as a countermeasure against harmonic suppression, or when imbalance of power supply voltage is 3% or above, or when power supply capacity is 500kVA or above. It is also used when a rapid change is made to power supply voltage. It is also effective in improving power factor.
<5>	Inverter noise filter (NF-□□□□)	This reduces the conductive noise that is generated from the inverter and transferred to the wire. Connect to the primary side (input side) of inverter.
<6>	Radio noise filter (zero-phase reactor) (ZCL-□)	When the inverter is used, noise may be generated on an adjacent radio or other devices through wiring on the power supply side. This is used for reducing the noise (reducing radiation noise).
<7>	Input-side radio noise filter (capacitor filter) (CFI-□)	This reduces the radiation noise that is emitted from the wire on the input side.
<8>	DC reactor (DCL-□-□□)	This suppresses harmonics generated from the inverter.
<9>	Braking resistor	This is used for increasing the braking torque of inverter, repeating power on and off at high interval, or reducing the speed of high load caused by moment of inertia.
<10>	Regenerative braking unit (BRD-□□)	
<11>	Output-side noise filter (ACF-C□)	This is installed between the inverter and motor to reduce the radiation noise that is emitted from the wire. It is used to reduce radio interference on radios or televisions or prevent malfunctioning of measurement instruments and sensors.
<12>	Radio noise filter (zero-phase reactor) (ZCL-□□□□)	This is applied for reducing noise generated on the output side of inverter. (It can be used on both the input side and output side.)
<13>	Output-side AC reactor (ACL-□-□□) for reducing vibration/preventing malfunctioning of thermal relay	When a general-use motor is driven by the inverter, compared with when it is run by commercial power supply, larger vibration may be generated. By connecting this device between the inverter and motor, you can reduce the vibration of motor. Also, if the wiring length between the inverter and motor is long (10m or longer), by inserting a reactor, you can prevent malfunctioning of the thermal relay caused by harmonic attributable to switching of inverter. You can also use a current sensor instead of the thermal relay.
<14>	LCR filter	This is a filter installed between the inverter and motor. It improves output current and voltage waveform to reduce motor vibration, noise, and radiation noise emitted from the wire to convert output-side waveform to sine wave. It is also effective in suppressing surge voltage.

**7.5.10** DC Reactor Connection Terminal (PD,P)



- We want to perform noise reduction.
- We want to take measures against harmonic noise.
- We want to improve power factor.



- These are terminals for connecting DC reactor DCL option used for improving power factor.
- By using the DCL option, you can reduce harmonic noise.



- When using the DC reactor DCL option, connect it after removing the short bar between the PD and P terminals.

**Prohibited**



- When not using the DC reactor DCL option, do not remove the short bar between the PD and P terminals.
- If the short bar between PD and P terminals is removed and the DC reactor DCL option is not connected, power is not supplied to the main circuit area of inverter, which disables operation.

**Electric shock**



**Do**



- The wiring length to DC reactor DCL shall be within 5m. Otherwise, you may not be able to get the desired effects.

**Caution**



- Please arrange the terminals so that heat generated from DCL does not affect the inverter.

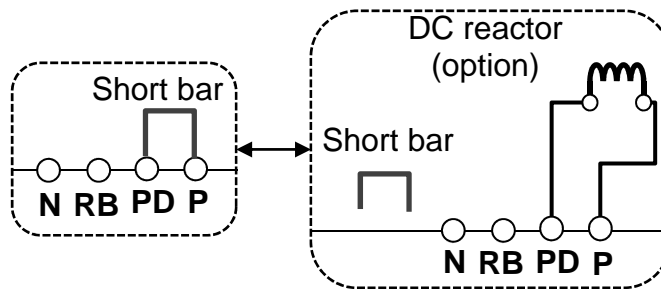

7.5.11 Regenerative Braking Option



- We want to set a short deceleration time, but overvoltage error occurs.
- When hanging the device for elevation or lowering, overvoltage error occurs.

7.5.12 Connection Terminals for External Braking Resistor (P,RB)



- In SJ series P1, braking resistor circuit is included in the following models as standard.  
P1-00044-L (004L) - P1-01240-L (220L)  
P1-00041-H (007H) - P1-00930-H (370H)
- By attaching the optional braking resistor, you can use the device even at large regenerative load (lowering load or load applied at high-speed rotation).

- With the braking resistor and regenerative braking unit, you can improve braking power and suppress overvoltage.
- To enhance braking power using an option, attach a braking resistor or braking unit.

**Prohibited**

- Do not attach a resistor whose resistance is lower than the predefined value. Otherwise, the regenerative braking (BRD) circuit may be damaged.

**Failure**

- Do not connect items other than the braking resistor to the RB terminal and P terminal.
- Do not short the RB terminal and P terminal.

**Caution**

- Please arrange the terminals so that heat generated from braking resistor does not affect the inverter.

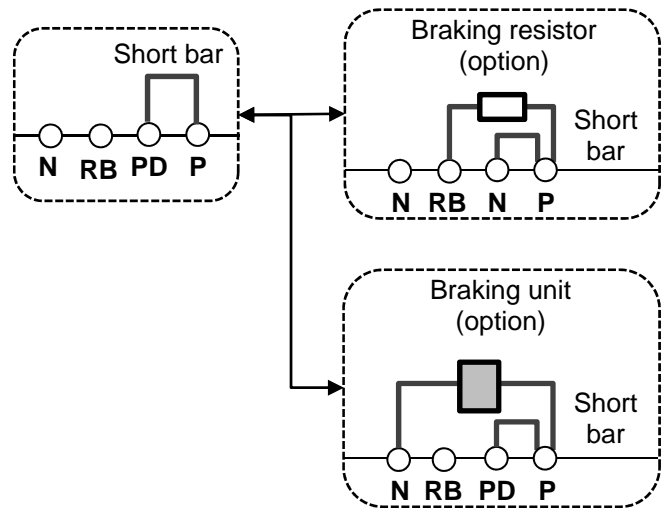

**7.5.13** Inverter Earth Terminal (G)

**Do**

- Make sure that the inverter and motor are grounded for use.

**Electric shock**

- Otherwise, you run the risk of electric shock.

**Do**

- Use grounding wires whose thickness is not less than that of the applicable wires and make them short as much as possible.

**Electric shock**

**Do**

- In accordance with the electric installation engineering standards, connect 200V-class model to the earth electrode completing class-D ground work (equivalent to the third class grounding: 100Ω or less grounding resistance) and 400V-class model to the earth electrode completing class-C ground work (equivalent to the special third class grounding: 10Ω or less grounding resistance).

**Electric shock**

**Prohibited**

- When more than one inverters are used, connect them that the grounding route (condition) should not be shared wires or loops. Otherwise, the inverter or peripheral control devices may malfunction.

**Mal-functioning**

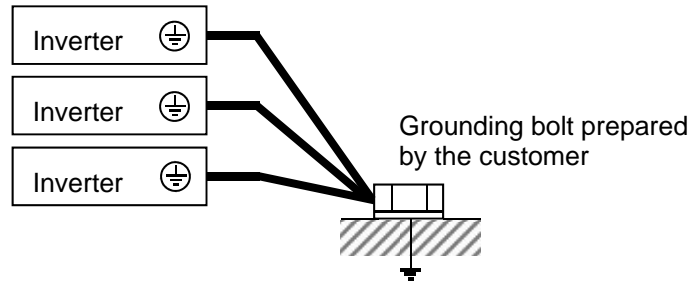
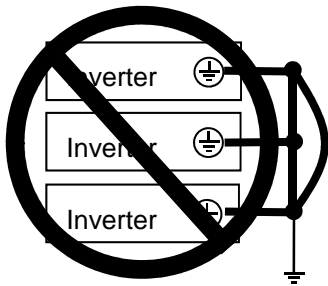

**7.5.14** Enable the Internal EMC Filter

**Q**

- We want to enable the internal EMC filter.
- We want to comply with European Directive.

**A**

- To enable the EMC filter, move the short bar or terminal.

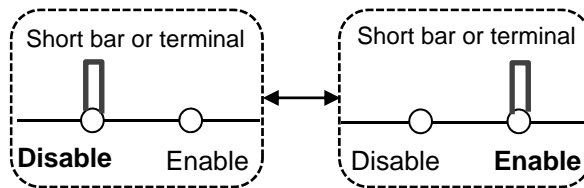

**!**

- For locations to be shorted, see the main circuit wiring diagram.

## 7.6 Operation and Optional Areas

### 7.6.1 Structure of Operation and Optional Areas

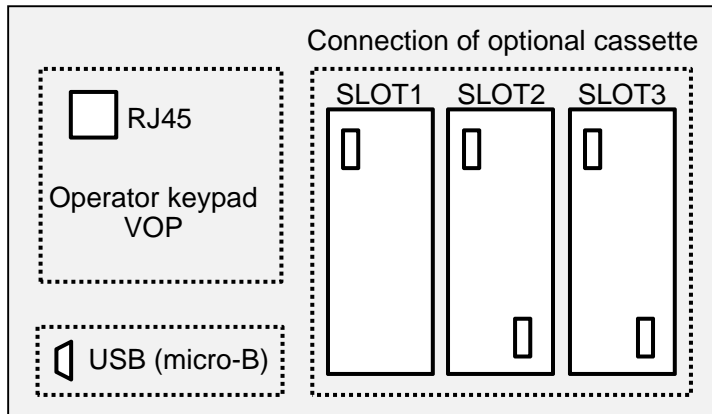

Operator keypad (factory default setting)  
The operator keypad is connected by default.

Option connection (factory default state)  
Optional slots are closed.

### 7.6.2 Description of Operation and Optional Areas

Connecting location	Name	Description
RJ45	Operator keypad VOP	The operator keypad VOP is connected. You can take out the operator keypad outside the panel using a straight LAN cable.
SLOT1	Optional cassette slot 1	You can connect various optional cassettes.
SLOT2	Optional cassette slot 2	You can connect various optional cassettes. The encoder feedback option must be connected to the slot 2.
SLOT3	Optional cassette slot 3	You can connect various optional cassettes.
USB (micro-B)	Connecting area for PC	By connecting with a PC, performs communication with a PC tool ProDriveNext.



- Before removing the operator keypad or disconnecting a USB device, be sure to turn off the power supply and wait until the POWER lamp goes off.
- When removing the operator keypad or disconnecting a USB device, hold the front cover. Otherwise, it may cause connection failure.
- Some extended options have predetermined connecting locations.
- Feedback option -> Slot 2
- Function safety option -> Slot 3

### 7.6.3 Take Out the Operator Keypad on the Panel



- We want to take out the operator keypad on the front side of the panel where the inverter is installed to operate it.



- You can take out the operator keypad VOP outside the panel for operation. When taking the VOP outside the panel, please contact the inverter technical communication center shown in the back cover.

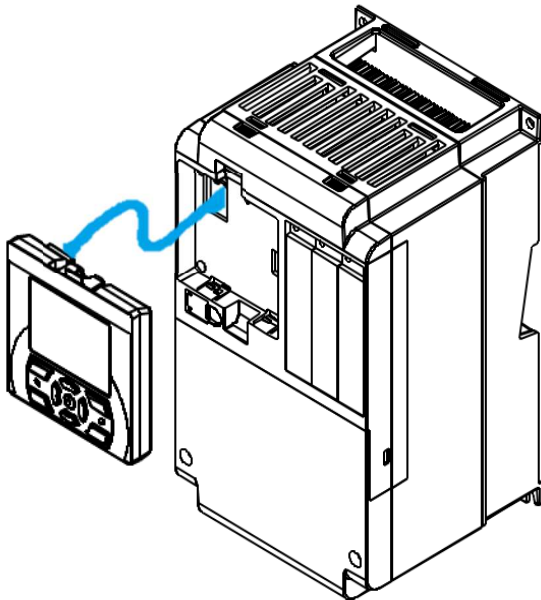

- To remove the operator keypad from the inverter to use it, order a connector cable option ICS-1 (1m) or ICS-3 (3m).
- If you prepare a cable by yourself, the following cables are recommended.
  - TSUKO Cat5e cable with connectors at both ends (twisted wire)
  - TSUNET-MC350E-MP 8C B 8-8
  - Hitachi Metals, Ltd. Straight wire with connectors at both ends
  - NETSTAR-C5E PC 24AWGX4P
- Use a connector cable within 3m. If you use the connector exceeding 3m, it may cause malfunctioning.
- While power is supplied to the inverter, do not attach or remove the operator keypad.

## 7.7 Control Circuit Terminal Area

### 7.7.1 Switch Configuration

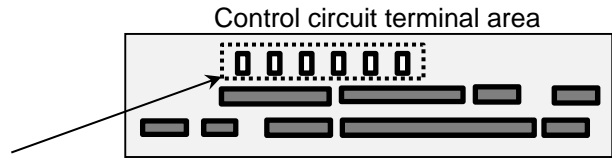
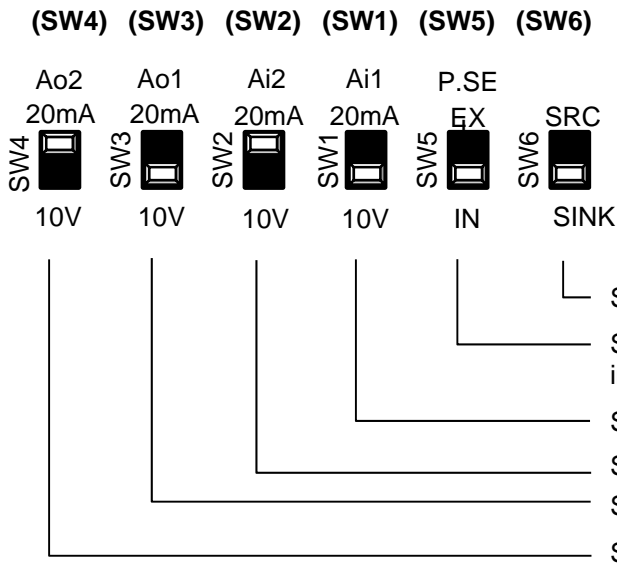

#### Points to be noted on switches

Failure
 

- Using a switch under power-on condition may cause failure. Use the switch only after turning off the power and confirming that the POWER lamp on the operator keypad is off.

 Do

Failure
 

- If the switch status does not match the actual input and output specifications, it may cause failure. Make sure to check that input and output to be used and switch characteristics are the same.

 Do

#### Description of switches

Indication	SW name	Description
Ai1 (SW1)	Analog input 1 switch	Switches input specification of analog input 1 (Ai1 terminal). 10V: Voltage input is available. 20mA: Current input is available.
Ai2 (SW2)	Analog input 2 switch	Switches input specification of analog input 2 (Ai2 terminal). 10V: Voltage input is available. 20mA: Current input is available.
Ao1 (SW3)	Analog output 1 switch	Switches output specification of analog output 1 (Ao1 terminal). 10V: Output changes to voltage output. 20mA: Output changes to current output.
Ao2 (SW4)	Analog output 2 switch	Switches output specification of analog output 2 (Ao2 terminal). 10V: Output changes to voltage output. 20mA: Output changes to current output.
P.SEL (SW5)	Switching the method of power supply to the input terminals	Switches the method of power supply to the input terminals. IN: Drives the input terminals using the internal power supply. EX: Inputs an external power supply to drive input terminals. (In the case of EX, a power supply is required between the input terminals and COM.)
SRC/SINK (SW6)	Switch of sink/source for the input terminals	Switches the sink/source logic for input terminals. This switch is enabled when SW5 is IN. SINK: Enables sink logic. SRC: Enables source logic.



**7.7.2** Wiring to the Control Circuit Terminal Block

■ Points to be noted on wiring the control circuit terminals

 Electric shock Failure

- L, COM, and CM2 are common terminals for input and output signals, and they are insulated from one another. Do not make these common terminals shorted or grounded.

 Prohibited

- Do not make them grounded via an external device.

 Mal-functioning

- Separate the wiring to the control circuit terminal block from that of the main circuit line (power line) or relay control circuit. If it is unavoidable to do so, make them positioned at right angles to each other. Otherwise, the inverter may malfunction.

 Do

 Do

- Although the control circuit terminal block has two lines, you can easily perform wiring by starting from the lower terminals. Make setting to perform wiring from the lower area.

 Do

- When wiring between Ai1 and L and between Ai2 and L, make sure to check that the positions of the corresponding DIP switches SW1 and SW2 are at the desired input (voltage or current).

 Failure

- Input of erroneous voltage or current caused by erroneous selection of switch or input of a value outside the specification range (using P24 terminal (24V) instead of H terminal (10V)), incorrect wiring (wires are installed in reverse orientation and input of voltage/current is reversed, short circuit occurs between H and L, wiring of a knob causes short circuit between H and L at 0Ω, etc.) may cause failure.

 Prohibited

 Mal-functioning

- For wiring to the control circuit terminal block, use twisted shield wires, and connect the shield films to each common terminal.

 Do

 Mal-functioning

- The wiring length to the control circuit terminal block shall be within 20m. If the connecting wire exceeds 20m, you may not be able to get sufficient characteristics due to effects of voltage drop. If it is unavoidable to set the length to more than 20m, use an analog insulation signal converter, and check that there is no problem with operation.

 Do

 Mal-functioning

- After wiring, lightly pull the wires to check that wires are securely connected.

 Do

 Do

- For output terminals and relay output terminals, install a diode for preventing counter-electromotive force.

 Failure

- Otherwise, counter-electromotive force is applied, which may cause failure.

**Recommended terminals for wiring**

- For the convenience of wiring and improvement of connection reliability, it is recommended to use rod terminals with the following specifications.
- For the control circuit terminal block, a spring clamp type terminal block is employed.

• Rod terminals with sleeve

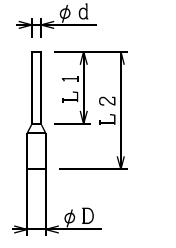
Wire size mm <sup>2</sup> (AWG)	Rod terminal model *1	L1 [mm]	L2 [mm]	φd [mm]	φD [mm]	
0.25 (24)	AI 0,25-8YE	8	12.5	0.8	2.0	
0.34 (22)	AI 0,34-8TQ	8	12.5	0.8	2.0	
0.5 (20)	AI 0,5-8WH	8	14	1.1	2.5	
0.75 (18)	AI 0,75-8GY	8	14	1.3	2.8	

\*1) Manufacturer: Phoenix Contact

Caulking tool CRIMPFOX UD 6-4 or CRIMPFOX ZA 3



**Method of wiring/detaching wires**

- Press in the orange portion on the control circuit terminal block using a slotted screwdriver (2.5mm or less in width).  
(The wire insertion slot opens.)
- While pressing the slotted screwdriver in the terminal block, insert the wire or rod terminal into the wire insertion slot (round hole).
- Extract the slotted driver to fix the wire.



- Also when extracting the wire, extract it while the orange portion is pressed in with the slotted screwdriver (the wire insertion slot is open).

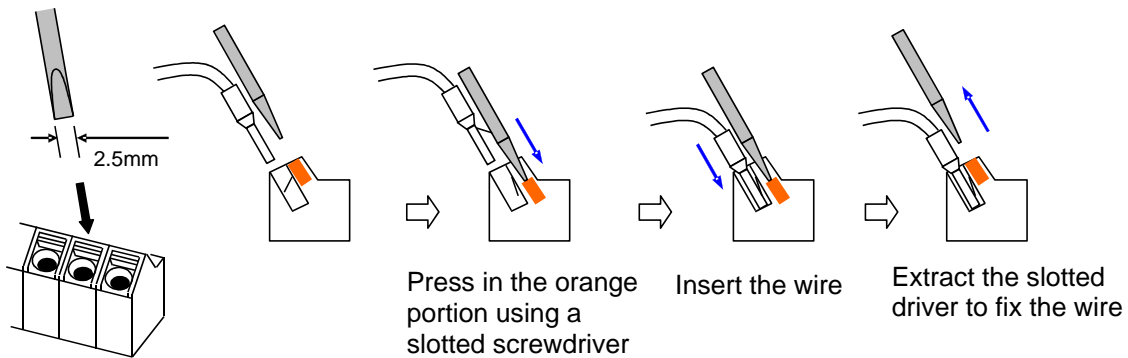

7.7.3 Wiring Portion Under Control Circuit

• [ ] indicates the factory default setting.

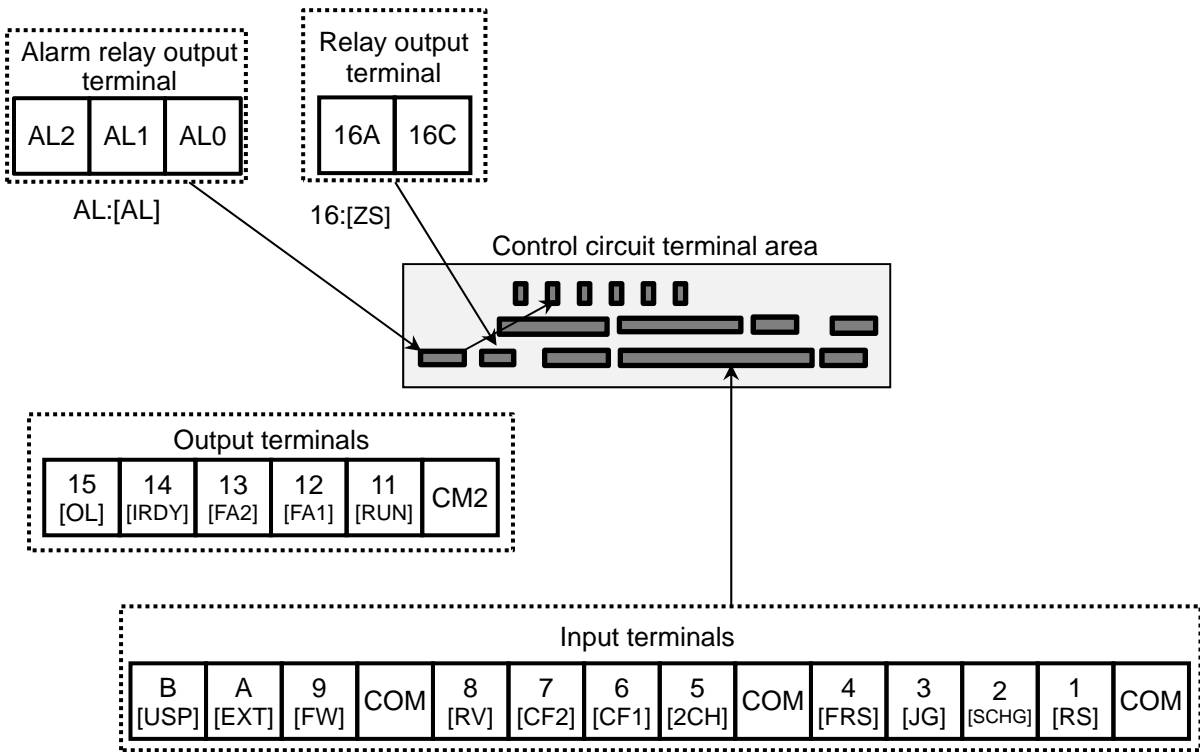

**Mal-functioning**

! Do

- When connecting contacts to control circuit terminals, use a relay that does not generate contact failure even at weak current or voltage emitted from cross-bar twin contacts.

**Logic of input terminals**

✓ Using SW6, switch the sink/source logic.

**Failure**

! Do

- When connecting a relay with output terminals, connect a diode for absorbing surge in parallel with the coil. Otherwise, internal elements may burn. (See the chapter for output terminals)

**Input terminals**

- All COM terminals are at the same potential.
- When connecting a power supply between 1-9, A, B and COM, switch SW5 to the external power supply (EX).
- You can switch between the sink/source logic of input terminals by using SW6.

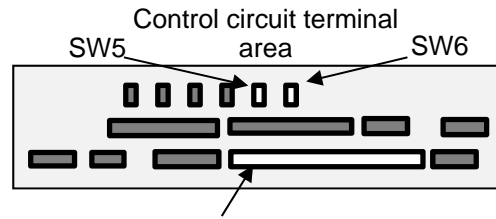

(Wiring example)

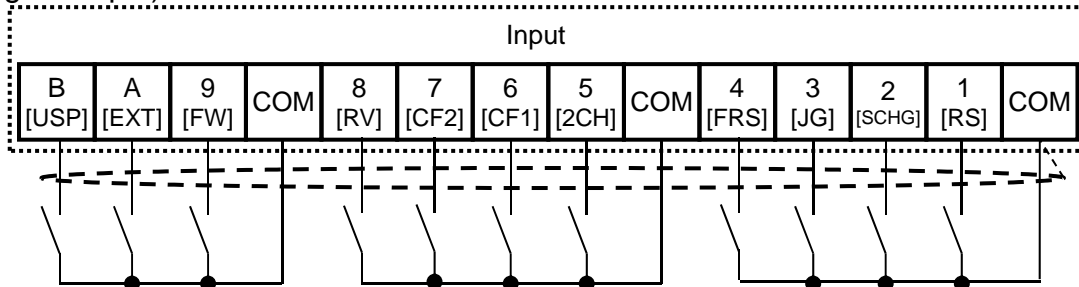

• [ ] indicates the factory default setting.

		Terminal symbol	Terminal name	Description	Electrical characteristics
Input terminal	Digital input	9, 8, 7, 6, 5, 4, 3, 2, 1	Input terminal	You can select terminal functions using the parameter settings corresponding to each terminal. You can switch between the sink logic and source logic by switching SINK/SRC of SW6.	Voltage between each input/COM • ON voltage Min. DC18V • OFF voltage Max. DC3V • Maximum allowable voltage DC27V • Load current 5.6mA (at DC27V)
	Contact/pulse	A	Pulse input-A	When [CA-90] is set to 00, A, and B terminals can be used as input terminals. You can select terminal functions using the parameter settings corresponding to each terminal.	Voltage between each input/COM • ON voltage Min. DC18V • OFF voltage Max. DC3V • Maximum allowable voltage DC27V • Load current 5.6mA (at DC27V) • Maximum 32kpps pulse input
		B	Pulse input-B	When [CA-90] is not set to 00, they are used as terminals for pulse string input. The maximum input pulse is 32kpps.	
	Common	COM	Common for input terminal	Common terminals for digital input terminals (1,2,3,4,5,6,7,8,9,A,B). There are three COM terminals.	

**Initial terminal function**

[RS] Reset

- Resets when trip occurs.

[SCHG] Switch of frequency command

- Switches between the main speed command [AA111](OFF) and auxiliary speed command [AA112](ON).

[JG] Jogging

- When operation command is input with [JG]ON, operation is performed at the frequency set for [AG-22].

[FRS] Free-run stop

- The motor performs free-run when [FRS] is ON.

[2CH] 2-stage acceleration/deceleration

- When [2CH] is ON, the acceleration/deceleration time 2[AC124]and [AC126] are enabled.

[EXT] External trip

- When [EXT] is ON, trip [E012] is issued.

[FW] normal rotation and [RV] reverse rotation

Normal rotation FW	Reverse rotation RV	Description
OFF	OFF	There is no command.
ON	OFF	Forward rotation command operation
OFF	ON	Reverse rotation command operation
ON	ON	There is no command (logic inconsistency).

[CF1] multistage speed 1 and [CF2] multistage speed 2 commands

Multistage speed 1 CF1	Multistage speed 2 CF2	Description
OFF	OFF	The set frequency command is enabled
ON	OFF	[Ab-11] frequency command is enabled
OFF	ON	[Ab-12] frequency command is enabled
ON	ON	[Ab-13] frequency command is enabled

\*) By configuring CF3 and 4, you can configure up to 15th speed.

[USP] Prevention of power restoration restarting

- When [USP] is ON, upon power-on, trip [E013] is issued if the operation command is issued.

**Output terminals**  
(Wiring example)

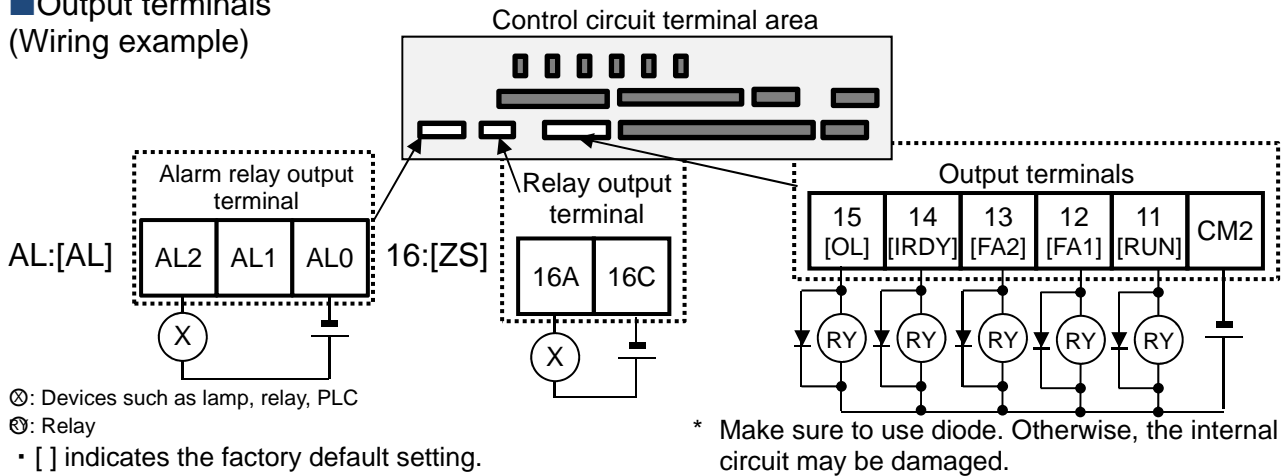

- ⊗: Devices such as lamp, relay, PLC
- ⊙: Relay
- [ ] indicates the factory default setting.

			Terminal symbol	Terminal name	Description	Electrical characteristics
Output terminal	Digital output	Open collector	15,14 13,12 11	Output terminal	You can select terminal functions using the parameter settings corresponding to each terminal. These terminals can be used both in sink logic or source logic.	Open collector output <ul style="list-style-type: none"> <li>• Between each terminal and CM2</li> <li>• Voltage drop at ON: 4V or below</li> <li>• Maximum allowable voltage: 27V</li> <li>• Maximum allowable current: 50mA</li> </ul>
			CM2	Common for output terminal	Common terminals for output terminals 11-15	
		Relay	16A 16C	1a relay terminal	A relay for contact A output.	Maximum capacity of contact <ul style="list-style-type: none"> <li>• AC250V, 2A (resistance)/AC250V, 1A (induction)</li> </ul> Minimum capacity of contact <ul style="list-style-type: none"> <li>• DC1V ,1mA</li> </ul>
			AL0 AL1 AL2	1c relay terminal	A relay for contact C output.	Maximum capacity of contact AL1/AL0 : <ul style="list-style-type: none"> <li>• AC250V, 2A (resistance)/AC250V, 0.2A (induction)</li> </ul> AL2/AL0 : <ul style="list-style-type: none"> <li>• AC250V, 1A (resistance)/ • AC250V, 0.2A (induction)</li> </ul> Minimum capacity of contact (common) <ul style="list-style-type: none"> <li>• AC100V, 10mA/DC5V ,100mA</li> </ul>

**Initial terminal function**

- [RUN:001] During operation signal
  - Turns ON during operation (PWM output).
- [FA1:002] Frequency reached signal
  - Turns ON when the output frequency reaches the command frequency.
- [FA2:003] Frequency reached signal 2
  - Turns ON when the output frequency reaches the set frequency [CE-10]-[CE-13].
- [IRDY:007] Operation ready completion
  - Turns ON when operation is ready.
- [OL:035] Overload advance notice
  - Turns ON when current exceeds the level of overload advance notice.
- [ZS:040] 0 Hz detection signal
  - Turns ON when the output frequency goes below the 0-Hz detection value level [CE-33].

About [AL] operation

• When [CC-17] = 00

Power supply	Status	AL0-AL1	AL0-AL2
ON	Normal	Open	Close
ON	Trip	Close	Open
OFF	—	Open	Close

• When [CC-17] = 01

Power supply	Status	AL0-AL1	AL0-AL2
ON	Normal	Close	Open
ON	Trip	Open	Close
OFF	—	Open	Close

7.7.4 Wiring Portion Above Control Circuit

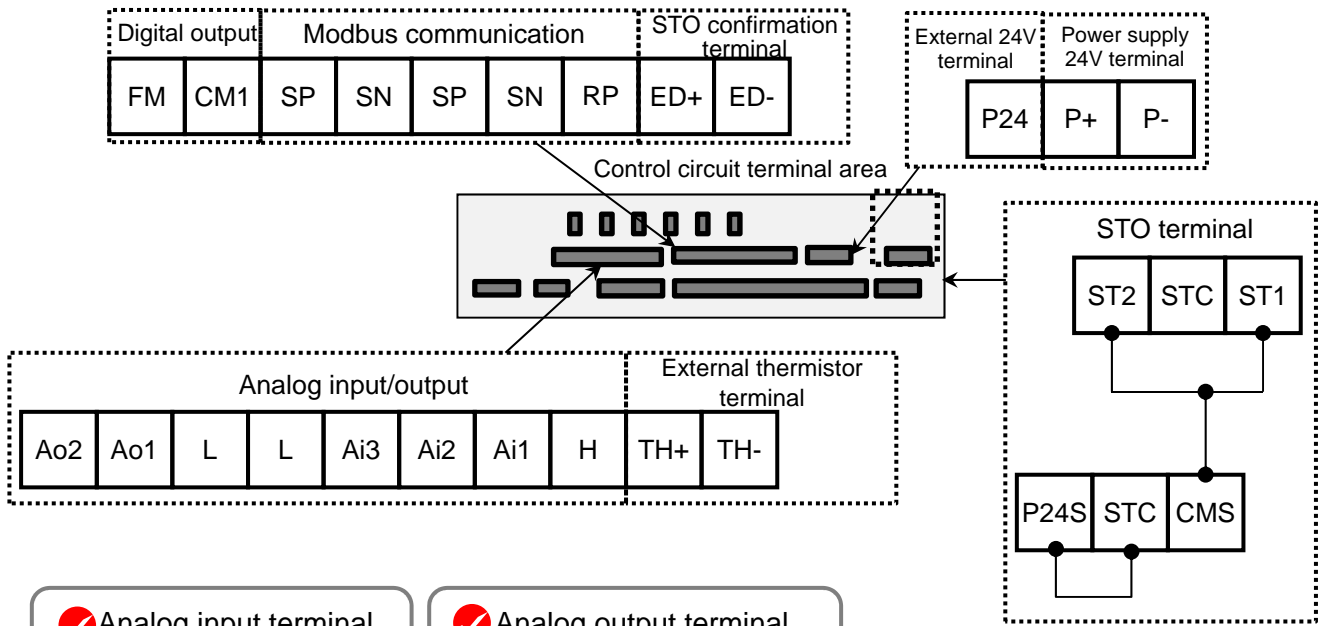

✓ **Analog input terminal (factory default state)**  
 The corresponding switches are as follows.

- Ai1 (voltage input): SW1
- Ai2 (current input): SW2

✓ **Analog output terminal (factory default state)**  
 The corresponding switches are as follows.

- Ao1 (voltage output): SW3
- Ao2 (current output): SW4

✓ **Connection of STO terminal**  
 When shipped from the factory, wiring is performed so that STO terminal is disabled.

**Failure** (Warning icon)

- Do not short between the analog power supply H and L terminals, power supply P+ and P- terminals, P24 and P- terminals, P+ and CM1 terminals, and P24 and CM1 terminals.

**Prohibited** (Prohibition icon)

- Otherwise, the inverter may fail.

■ Analog input/output  
(Wiring example)

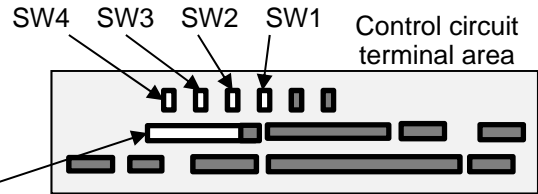
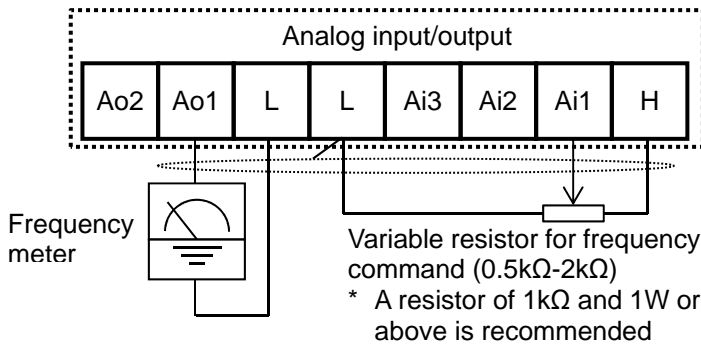

- In the example shown on the left, voltage is input when the variable resistor is used in H-Ai1-L, therefore, set the SW1 of analog input 1 (Ai1) to the voltage side.
- In the example shown on the left, if the frequency meter supports current measurement feature (4-20mA), set the SW3 of analog output 1 (Ao1) to the current side of SW3.

	Terminal symbol	Terminal name	Description	Electrical characteristics	
Analog input terminal for switching voltage and current	Power supply	L	Analog power common	Common terminals for analog input terminals (Ai1, Ai2, Ai3) and analog output terminals (Ao1, Ao2). There are two L terminals.	
		H	Power supply for setting speed	This is a DC10V power supply. It is used when using analog input terminals (Ai1, Ai2, Ai3) and variable resistor for inputting voltage.	Maximum allowable input current 20mA
	Analog input	Ai1	Analog input terminal 1 (voltage/current switching SW1)	For Ai1 and Ai2, DC0-10V voltage input and 0-20mA current input can be switched using a switch for use. It can be used for input frequency command or feedback.	In the case of voltage input: <ul style="list-style-type: none"> <li>• Input impedance about 10kΩ</li> <li>• Allowable input voltage DC-0.3V-12V</li> </ul>
		Ai2	Analog input terminal 2 (voltage/current switching SW2)		In the case of current input: <ul style="list-style-type: none"> <li>• Input impedance about 100Ω</li> <li>• Maximum allowable input current 24mA</li> </ul>
		Ai3	Analog input terminal 3	DC-10V to 10V voltage input is available. It can be used for input frequency command or feedback.	Only voltage input: <ul style="list-style-type: none"> <li>• Input impedance about 10kΩ</li> <li>• Allowable voltage input DC-12V to 12V</li> </ul>
	Analog output	Ao1	Analog output terminal 1 (voltage/current switching SW3)	For Ao1 and Ao2, DC0-10V voltage output and 0-20mA current output can be switched using a switch as output of information monitor data of the inverter.	In the case of voltage output: <ul style="list-style-type: none"> <li>• Maximum allowable output current 2mA</li> <li>• Output voltage accuracy ±10% (ambient temperature: 25°C±10°C)</li> </ul>
		Ao2	Analog output terminal 2 (voltage/current switching SW4)		In the case of current input: <ul style="list-style-type: none"> <li>• Allowable load impedance 250Ω or below</li> <li>• Output current accuracy: ±20% (ambient temperature: 25±10°C)</li> </ul>

■ External thermistor  
(Wiring example)

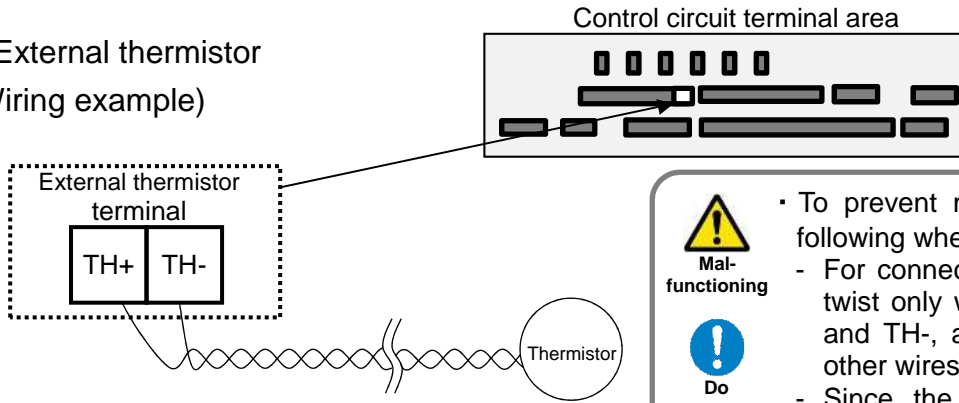

**Mal-functioning**

- To prevent malfunctioning, note the following when performing wiring.
- For connection to the TH terminal, twist only wires connecting to TH+ and TH-, and separate them from other wires.
- Since the current flowing in the thermistor is very weak, separate the wires from main circuit line (power line).
- The length of wiring to the thermistor shall be within 20m.

**Do**

		Terminal symbol	Terminal name	Description	Electrical characteristics
Thermistor terminal	Analog input	TH+	External thermistor input	When an external thermistor is connected, and resistance abnormality occurs due to abnormal temperature, etc., trip the inverter. Connect the thermistor with TH+ and TH-. The level of detecting resistance abnormality can be adjusted from 0 to 10000Ω. [Recommended thermistor characteristics] Recommended product: SHIBAURA ELECTRONICS Co., Ltd. PB-41E Allowable rated power: 100mW or more Impedance at abnormal temperature: 3kΩ	DC0~5V [Input circuit]
		TH-	Common for external thermistor		



■ FM output terminal

(Wiring example)

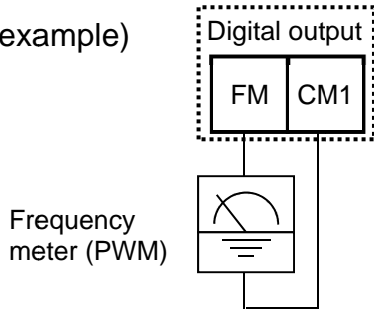

**A**

- For FM output, you can choose the PWM output method with 6.4ms fixed interval or pulse output method in which pulse frequency varies.
- You can control FM output by setting parameters.

			Terminal symbol	Terminal name	Description	Electrical characteristics
Digital	output	Monitor output	FM	Digital monitor (voltage)	For digital monitor output, you can choose the PWM output method at 6.4ms interval or pulse output method with about 50% duty in which frequency varies.	Pulse string output DC0-10V • Maximum allowable current 1.2mA • Maximum frequency 3.60kHz
			CM1	Common for digital monitor	The common terminal for digital monitor.	

■ Power input/output

(Wiring example)

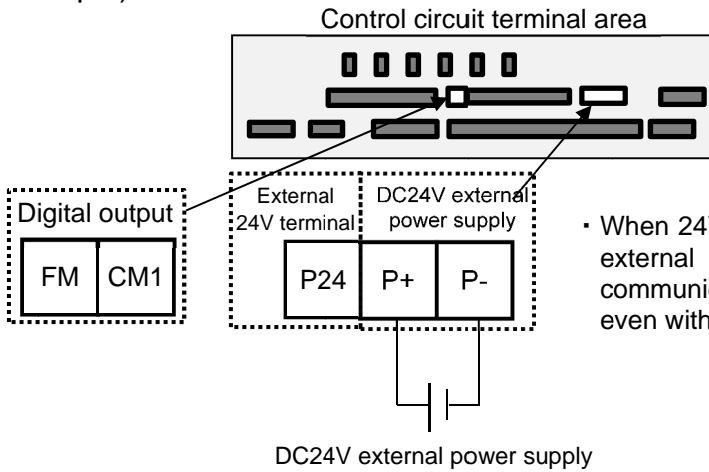

- When 24V power is supplied to P+ and P- from an external source, change of parameters and communication of optional devices are enabled even without main power supply.

			Terminal symbol	Terminal name	Description	Electrical characteristics
24V power supply	Power input	P24	24V output power terminal	DC24V power supply for contact signal. The common terminal is P-.	100mA output at maximum	
		P+	External 24V input terminal (24V)	Input an external DC24V power to the inverter. With input of 24V power, you can change parameter settings or operate optional communication without using a control power supply.	Allowable input voltage DC24V ± 10% Maximum power consumption 1A	
		P-	Terminal for P24/P+ (0 (zero) V)			

Serial communication

(Wiring example)

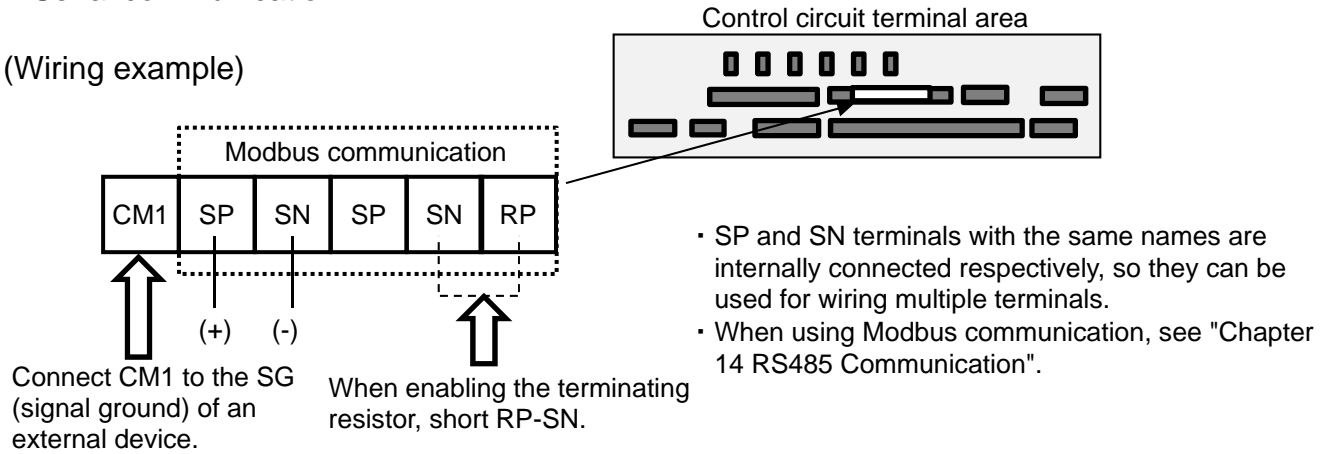

	Terminal symbol	Terminal name	Description	Electrical characteristics
RS485 communication	SP SN RP (CM1)	RS-485 terminal for Modbus communication	SP terminal: RS-485 differential (+) signal SN terminal: RS-485 differential (-) signal RP terminal: Connect to SP via the terminating resistor CM1 terminal: Connect with the signal ground of an external communication device. (also used by FM terminal) There are two SP terminals and SN terminals each, which are connected internally. Maximum baud rate is 115.2kbps.	Equipped with terminating resistor (120Ω) Enable: Short RP-SN Disable: Open RP-SN

STO terminal

- For the terminal function, see "21.4 STO Terminal Function".
- \* The section above describes only the function of STO terminal. If certification of function safety is needed, see the SJ-P1 Safety Function Guide separately provided.

Terminal symbol	Terminal name
P24S	24V output power terminal
CMS	Common terminal for STO terminal
STC	Logic switching terminal
ST1	STO input 1
ST2	STO input 2
ED+	Monitoring output terminal
ED-	Monitoring output common

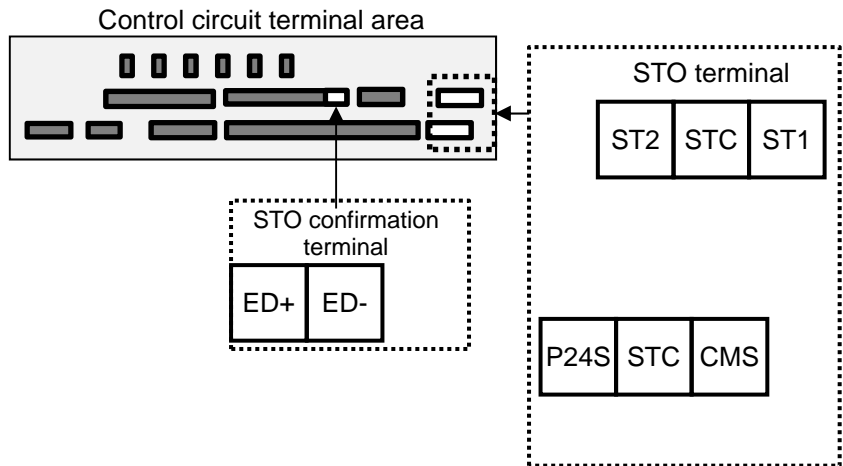

(Memo)

## 8

## Chapter 8 Operation Check/Residual Risks

### Contents

8.1 What This Chapter Explains .....	8-1
8.2 Content of the Checklist.....	8-1
8.3 Sections with Residual Risks.....	8-2
8.4 Residual Risk Checklist .....	8-3

### 8.1 What This Chapter Explains

This chapter describes residual risks in operation and items to be checked concerning the risks.

The customer who use this product shall appropriately perform risk assessment before performing trial run or using the product, and appropriately protect their personnel and systems.

Although this chapter describes all the possible measures to make sure, it does not cover all the risks in your systems. Please note that we will bear no responsibility for damages resulting from causes described in this chapter. Make sure to perform risk assessment of the system equipped with this product.

Also, make sure to carefully read "Chapter 1 Safety Instructions/Risks" for safety work.

### 8.2 Content of the Checklist

The items in the checklist shown in the next section are classified in accordance with the following definitions in the same way as "Chapter 1 Safety Instructions/Risks".

#### **DANGER**

Indicates that incorrect handling may cause hazardous situations, which have a high chance of resulting in serious personal injury or death, and may result in major physical loss or damage.

#### **WARNING**

Indicates that incorrect handling may cause hazardous situations, which may result in serious personal injury or death, and may result in major physical loss or damage.

#### **CAUTION**

Indicates that incorrect handling may cause hazardous situations, which may result in moderate or slight personal injury or damage, and may result in physical loss or damage alone.

8.3 Sections with Residual Risks

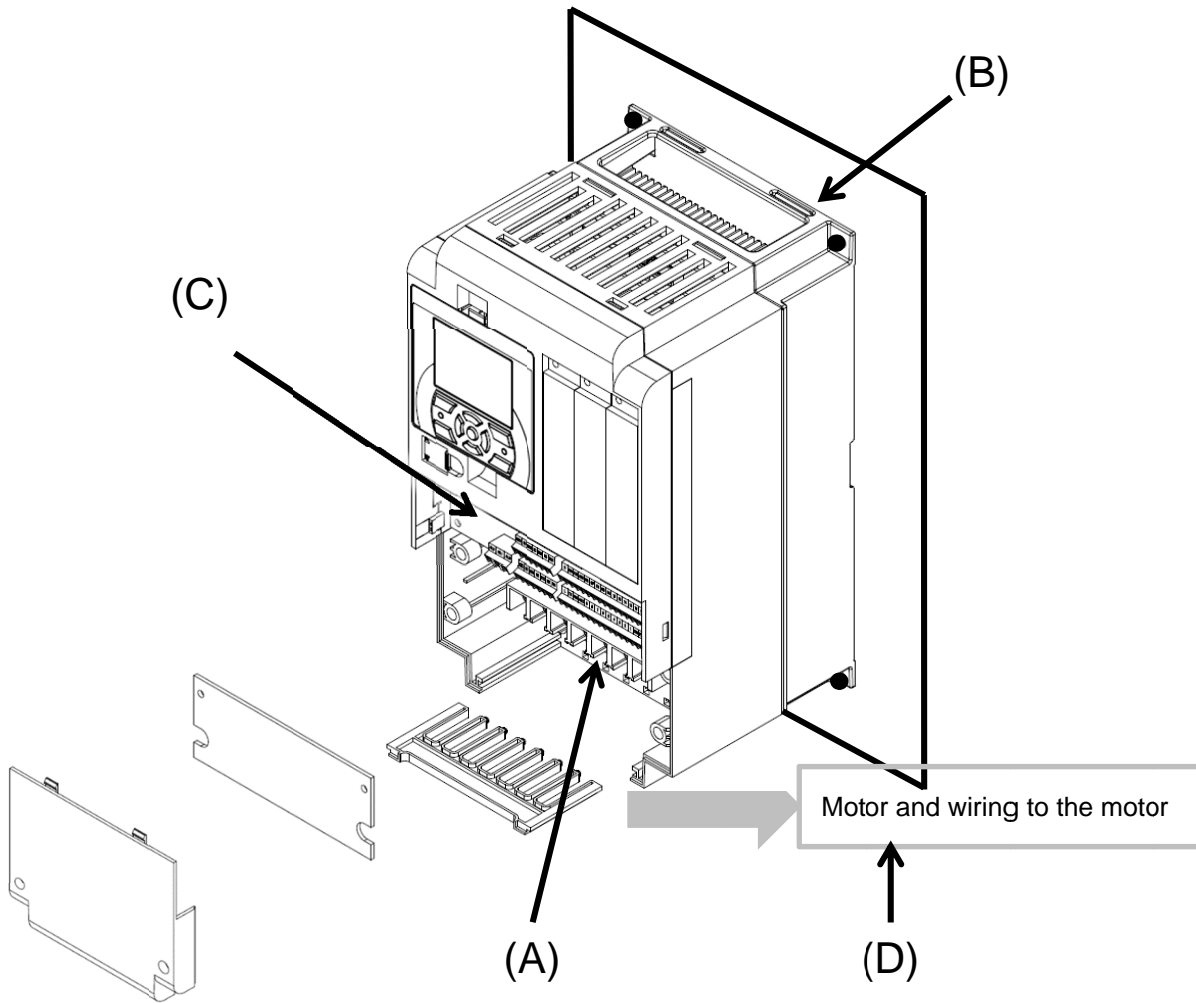

■ Residual risk checklist No.

No.	Section name	⚠ DANGER	⚠ WARNING	⚠ CAUTION
(A)	Main circuit terminal block	8, 10		
(B)	Heat sink	4		1
(C)	I/O terminal block	11		
(D)	Motor connected with the inverter and wiring to the motor	12, 13		
-	Unknown section	9, 14, 15		2, 3, 5, 6, 7

## 8.4 Residual Risk Checklist

No.	Operation stage	Work	Target section	Residual risk	Details of harm	Protective measure	√
1	Installation	Installation	(B)	Caution	Damage caused by careless transport	Do not drop the product. Do not carry the inverter in a manner that applies force to the cover or operator keypad.	<input type="checkbox"/>
2	Installation	Installation	-	Caution	Reduction of component life due to use in a location exposed to direct sunlight or at a temperature outside the specification range.	Check that ambient temperature is within the standard specification range in the whole year by means of cooling and ventilation.	<input type="checkbox"/>
3	Installation	Installation	-	Caution	Failure due to short circuit caused by using in a location which humidity and condensation are out of standard range described in specification..	Check that ambient temperature is within the standard specification range in the whole year by means of cooling and ventilation. Otherwise, install the product in a location free from condensation.	<input type="checkbox"/>
4	Installation	Installation	(B)	DANGER	The cooling fin that is heated to exceed 150°C sets fire to a flammable wall.	Install the inverter on an inflammable metal wall.	<input type="checkbox"/>
5	Installation	Installation	-	Caution	Component failure due to entry of dust, corrosive gas, or other substances.	Install the inverter inside a totally enclosed panel.	<input type="checkbox"/>
6	Installation	Installation	-	Caution	Reduction of a component life due to degradation of cooling capability by horizontal installation	Install it vertically.	<input type="checkbox"/>
7	Installation	Installation	-	Caution	When the fin is installed outside the inverter, the cooling fan fails due to droplet, oil mist, etc.	When installing the fin outside the inverter, install it in a location free from droplet, oil mist, etc.	<input type="checkbox"/>
8	Maintenance for installation	Electrical connections	(A)	DANGER	Arc flew out due to screws that are loosened by vibration, and set fire to the internal components.	Check screws are appropriately tightened on a regular basis.	<input type="checkbox"/>
9	Maintenance for installation	Electrical connections	-	DANGER	Arc flew out due to screws that are loosened by vibration, and set fire to combustibles.	Check screws are appropriately tightened on a regular basis. Do not place flammable materials near the installed inverter.	<input type="checkbox"/>
10	Maintenance before use	Wiring Inspection	(A)	DANGER	When the cover is removed, electric shock is caused in a high-voltage section.	Do not remove the cover when power is supplied. After power is turned off, wait 10 minutes or more to perform working.	<input type="checkbox"/>
11	Maintenance before use	Wiring Inspection	(C)	DANGER	When the operator removes the cover, electric shock is caused when a tool touches a high-voltage section.	Do not remove the cover when power is supplied. After power is turned off, wait 10 minutes or more to perform working.	<input type="checkbox"/>

\* Installation, wiring, and setting work need to be performed by specialized technicians.

No.	Operation stage	Work	Target section	Residual risk	Details of harm	Protective measure	√
12 (a)	Installation	Electrical connections	(D)	DANGER	Due to long wiring length, insulation degraded by surge, which eventually burns the motor.	If the wiring length exceeds 20m, shorten the motor wiring length. Install the optional LCR filter and ACL.	<input type="checkbox"/>
12 (b)	Installation	Electrical connections	(D)	DANGER	Since a motor with different voltage class is connected to the inverter, insulation degraded by surge, which eventually burns the motor.	Match the voltage class of inverter and that of motor.	<input type="checkbox"/>
12 (c)	Installation	Electrical connections	(D)	DANGER	Due to unstable output caused by imbalance of power supply voltage, undervoltage, extreme voltage drop, aging of motor, the motor burns, and eventually the inverter fails.	Check the receiving voltage of inverter, power receiving method, and power supply capacity are appropriate.	<input type="checkbox"/>
12 (d)	Use Maintenance	Wiring Inspection	(D)	DANGER	The short circuit failure caused by degradation of motor insulation, cracking of aged wires, etc., causes phase loss on inverter output, motor cable, and motor. Driving the inverter in such a condition burns the motor, and eventually the inverter fails.	Check there is no phase loss by inspection.	<input type="checkbox"/>
12 (e)	Installation Use	Setting	(D)	DANGER	By performing inappropriate parameter settings, high current flows in the motor, causing it to burn.	Set appropriate values for parameters related to motor electronic thermal function [bC-01] to [bC125]. Set appropriate values for the settings of base frequency, rated motor voltage, motor constant, duty rating, and DC output of control mode and motor. (representative parameters) Motor-related parameters: IM: [Hb102]–[Hb118] SM (PMM): [Hd102]–[Hd118] Control mode: [AA121] Duty rating: [Ub-03] DC braking: [AF101] - [AF109]	<input type="checkbox"/>
13	Use	Operation	(D)	DANGER	The stopped motor automatically starts running.	To restart the motor after stopping it by a function, define it in the system.	<input type="checkbox"/>
14	General	General	-	DANGER	Damage and injury caused by hidden risks.	Perform risk assessment on the system, and check that the fail safe function is incorporated into the system.	<input type="checkbox"/>
15	General	General	-	DANGER	Damage and injury caused by failure to obtain additional information concerning risks.	Obtain the latest version of User's Guide so that necessary information can be checked. Communicate information to the end users as necessary.	<input type="checkbox"/>

\* Installation, wiring, and setting work need to be performed by specialized technicians.

\* When using the [SET] terminal function of input terminals, also check the second settings.

# 9

## Chapter 9 Operating

### Contents

- 9.1 What This Chapter Explains ..... 9-1
- 9.2 Start Operating the Inverter! ..... 9-2
  - 9.2.1 Operator Keypad and Icon Display ..... 9-2
  - 9.2.2 Transition of Operator Keypad Screen..... 9-6
- 9.3 Set up parameters! ..... 9-7
  - 9.3.1 Checking the List and Configuring "Scroll Mode" ..... 9-7
  - 9.3.2 Changing a Parameter While Watching a Monitor "Concurrent Monitor" ..... 9-11
- 9.4 Monitor Inverter Information! ..... 9-13
  - 9.4.1 Three-Line Monitor Screen "Multi-Monitor" ..... 9-13
  - 9.4.2 Setting Screen "Concurrent Monitor" ..... 9-14
  - 9.4.3 Monitor with Large Characters "Big Monitor" ..... 9-15
- 9.5 Check Error History! ..... 9-16
  - 9.5.1 Trip History "Total Count Monitor" ..... 9-16
  - 9.5.2 Retry History "Why Retry Monitor" ..... 9-17
- 9.6 Copy Data! ..... 9-18
  - 9.6.1 READ Function ..... 9-18
  - 9.6.2 WRITE Function ..... 9-19
- 9.7 System Settings! ..... 9-20
- 9.8 Change Assist Bar Information! ..... 9-22
- 9.9 Supplementary Information ..... 9-23
- 9.10 Parameter Functions ..... 9-24
  - 9.10.1 Protecting Parameters (Prohibiting Change) ..... 9-24
  - 9.10.2 Limiting Displayed Parameters ..... 9-25
  - 9.10.3 Saving Automatically Changed Parameters ..... 9-33
  - 9.10.4 Protecting Parameters by Password ..... 9-34
- 9.11 Display Fixation Function ..... 9-36
  - 9.11.1 Fixation of Display Using the DISP Terminal ..... 9-36
- 9.12 Error Operation on the Operator Keypad .... 9-37
  - 9.12.1 Selection of Operation at Disconnection of Operator Keypad ..... 9-37
  - 9.12.2 Display of Battery Level Warning ..... 9-38
- 9.13 Preventing Read and Write of Unnecessary Data ..... 9-39
  - 9.13.1 Disabling Data R/W ..... 9-39

### 9.1 What This Chapter Explains

The chapter provides explanations of the liquid crystal operation panel VOP (Viewable Operator Panel). What can be done with VOP and use methods are provided.

When using the inverter, make sure to carefully read "Chapter 1 Safety Instructions/Risks" for safety work.

(Tips)



- I want to go back to the menu without saving changes.
- I want to go back to the previous window.
- I want to go back because I don't know what to do next.



- The cancel function is assigned to the F1 key. Press the F1 key to go back.



- For details, see the following sections.

Symbol	Meanings
	General and troubleshooting questions
	Key points for a solution
	Notes
	Confirmation of procedures



## 9.2 Start Operating the Inverter!

### 9.2.1 Operator Keypad and Icon Display

**Q**

- I don't know how to use the operator keypad VOP.
- I don't understand what is shown on the window.

**A**

- The overview of the operator keypad is given below.
- \* The color of the screen image may be different from the actual color.

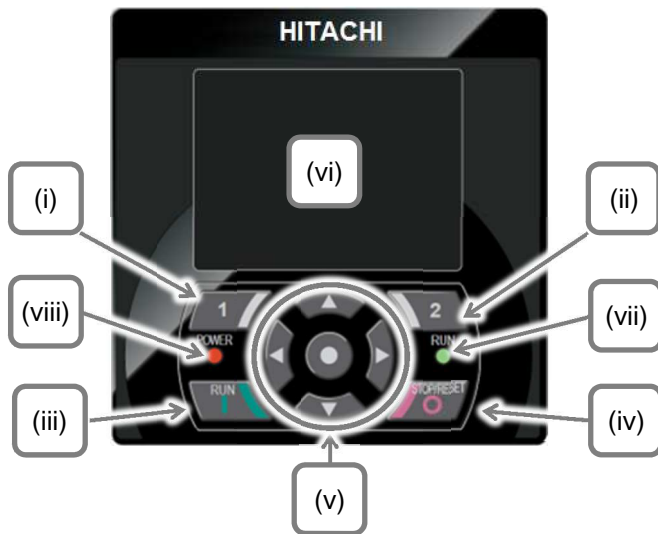

No.	Name	Setting
(i)	F1 key	Displays functions such as navigation to the home screen and cancellation at the bottom left of the screen.
(ii)	F2 key	Displays functions such as data storage at the bottom right of the screen.
(iii)	RUN key	The device runs when this key is enabled.
(iv)	STOP/RESET key	Performs deceleration stop and trip reset.
(v)	Arrow keys & SEL key (center)	Select data on the screen using arrow keys, and confirm by pressing the O key in the center.
(vi)	Display screen	Displays parameters and data.
(vii)	RUN lamp	Turns on when an operation command is sent.
(viii)	POWER lamp	Turns on when the operator keypad is ON. Turns on when R0 and T0 on the main circuit or P+ and P- on the terminal block are ON.

- About display screen (vi)

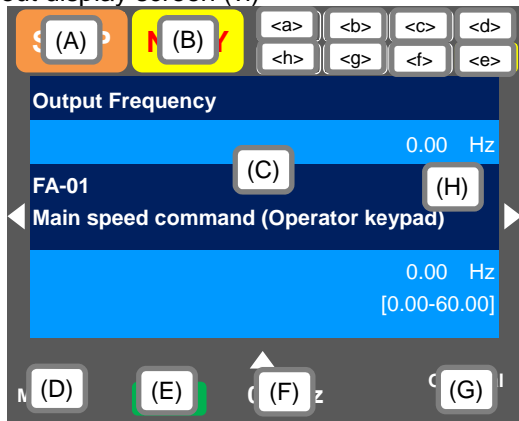

No.	Description
(A)	Displays the operation status.
(B)	Displays the warning status.
(C)	Displays data/parameters.
(D)	Displays details of the function assigned to the F1 key.
(E)	Displays the operation of RUN key on the operator keypad.
(F)	Displays frequency command, torque command, inverter name, clock, etc. The function to be displayed in this section can be selected using the F2 key (option) on the main screen.
(G)	Displays details of the function assigned to the F2 key.
(H)	When soft-lock function is enabled, the [LKS] mark is displayed.

No.	Name	Description
<a>	Power status	Displays the type of input power supply.
<b>	SET function	Displays which of the first setting or second setting is selected for SET terminal function.
<c>	Parameter	Displays the status of display restriction mode.
<d>	Screen No.	Displays the screen number.
<e>	STO function	Displays the STO command.
<f>	Control mode	Displays the command control mode.
<g>	EzSQ	Displays the program operation of EzSQ.
<h>	Special status	Displays the operation of special function.

- Sections of display screen on the operator keypad

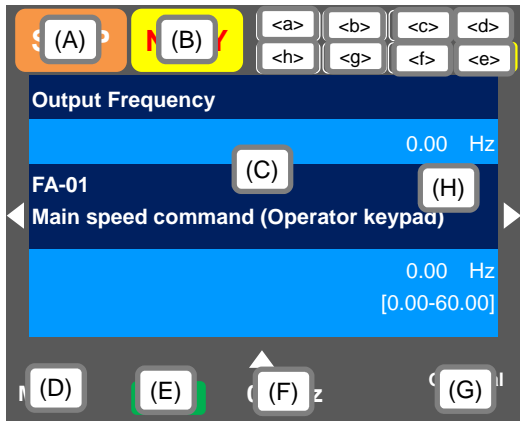

**Display (A) Main Operation status display**

No.	Indication	Description
A1		Displayed during normal rotation operation. There is a parameter that cannot be changed during operation.
A2		Displayed during reverse rotation operation. There is a parameter that cannot be changed during operation.
A3		Output is in process by 0Hz command. This is also displayed by DB, FOC, and SON functions. There is a parameter that cannot be changed during operation.
A4		Displayed during trip after the occurrence of error. For errors that cannot be canceled, perform reset operation to cancel. -> 18.3.1 Checking the Trip Information
A5		Displayed when setting inconsistency occurs. Resolve the inconsistency. -> 18.5.2 Checking the Setting Inconsistency
A6		This is displayed when the device is forcibly stopped by a function although an operation command is issued. <ul style="list-style-type: none"> <li>The operation command is issued with frequency command at 0Hz.</li> <li>When the operation command is issued from a source other than the operator keypad, the device is stopped by the STOP key on the operator keypad.</li> <li>When the operation command is issued from a source other than the operator keypad, the device is stopped by the breaking terminal function [RS], [FRS], etc.</li> <li>The device is stopped by the instantaneous power failure non-stop function.</li> </ul> At this time, the RUN lamp blinks.
A7		The operation is suspended due to lack of operation command. <ul style="list-style-type: none"> <li>If the operation command is issued from than the operator keypad, the operation is stopped when the breaking function is enabled.</li> </ul>

(Tips)

- A6: When set to STOP (in red)
- > If Display(F): Frequency command is set to 0.00Hz, the frequency command is 0Hz. Check if the frequency command is issued.
- > For example, while the device is running with the [FW] terminal, if it is stopped by the stop key, operation restarts when the [FW] terminal is turned on after turned off once.

**Display (B) Warning status display**

No.	Indication	Description
B1		This is displayed by the following functions. <ul style="list-style-type: none"> <li>Under overload limit</li> <li>Under torque limit</li> <li>Under overcurrent suppression</li> <li>Under overvoltage suppression</li> <li>Under upper/lower limit operation</li> <li>Under jump frequency operation</li> <li>Under minimum frequency limit</li> </ul>
B2		This is displayed by the following functions. <ul style="list-style-type: none"> <li>Overload advance notice</li> <li>Motor thermal advance notice</li> <li>Inverter thermal advance notice</li> <li>Motor heating advance notice</li> </ul>
B3		Displayed during retry standby or restart standby.
B4		Operation is not started even if the operation command is issued. <ul style="list-style-type: none"> <li>Under insufficient voltage of the main power</li> <li>Under operation only by the 24V power supply</li> <li>Under reset operation</li> <li>Off when the [REN] terminal function is enabled</li> </ul>
B5		Displayed upon the fan life advance notice.
B6		Displayed upon the capacitor life advance notice on the circuit board.
B7		Displayed upon the fan life advance notice and capacitor life advance notice on the circuit board.
B8	(None)	A status other than above

(Tips)

- B1:LIM and B2:ALT are displayed when current or internal voltage is rising. If an error occurs, load or other element needs to be reconsidered.
- If it is determined that the life of cooling fan or capacitor on the circuit board is ending, the indication above is displayed.

**Display (E) Display of RUN key function on the operator keypad**

No.	Indication	Description
E1		Normal rotation by the RUN key on the operator keypad.
E2		Reverse rotation by the RUN key on the operator keypad.
E3	>FW icon"/>	The RUN key is enabled by the [F-OP] terminal or VOP function. (Normal rotation)
E4	>RV icon"/>	The RUN key is enabled by the [F-OP] terminal or VOP function. (Reverse rotation)
E5	(None)	The command other than the RUN key is selected.

(Tips)

- This section is displayed when the RUN key on the operator keypad is enabled.
- To run the device from the operator keypad while this item is not displayed, check [AA111] first.

- Sections of display screen on the operator keypad

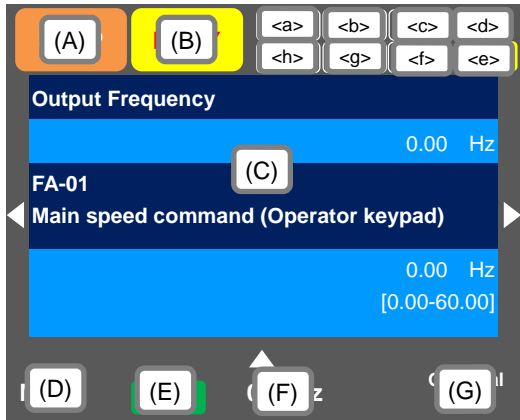

**<a> Power status display**

No.	Indication	Description
a1	(None)	There is input to the main power supply/control power supply.
a2	CTRL	There is input to the control power supply.
a3	24V	The device runs with 24V input to P+/P-.

(Tips)

- Indicates the status of power input. When CTRL or 24V is displayed, main power is not input, which makes operation impossible. Check the power supply.

**<b> Display of SET function operation status**

No.	Indication	Description
b1	M1	The [SET] terminal is not selected or the [SET] terminal is selected but the function is disabled. (common setting and first setting are enabled)
b2	M2	The [SET] terminal is selected and the function is enabled. (common setting and second setting are enabled)

- If the [SET] terminal is not used, M1 is displayed. If the center of parameter is “-” (common setting such as [AC-01]) or “1” (first setting such as [AA111]), the setting is enabled, and “2” (second setting such as [AA211]) is ignored.

**<c> Selection of parameter display**

No.	Indication	Description
c1	(None)	All-parameter display mode.
c2	UTL	Individual-function display mode.
c3	USR	User-setting display mode.
c4	CMP	Data-comparison display mode.
c5	MON	Monitor display mode.

(Tips)

- This section is displayed when the display limit function is working. If there is a hidden parameter, change the setting in [UA-10].

**<d> Display of monitor screen No.**

(Tips)

- Displays the screen number of each monitor. When making inquiries, please tell us the number of monitor displayed on your screen. The list of monitor screen numbers is shown in the next page.

**<e> STO function display**

(Tips)

- If the function is displayed, it means the current is shut off.
- \* For details of the STO function display, please contact us.

**<f> Display of control command mode**

No.	Indication	Description
f1	(None)	The speed control mode.
f2	TRQ	The torque control mode.
f3	POS	The position control mode.

(Tips)

- Indicates the mode of control operation.

**<g> Display of EzSQ operation mode**

No.	Indication	Description
g1	(None)	EzSQ is not selected.
g2	Ez_S	The EzSQ program is stopped.
g3	Ez_R	The EzSQ program is working.

(Tips)

- You can check whether the EzSQ function is working.

**<h> Display of special function status**

No.	Indication	Description
h1	(None)	The device is not in the special status.
h2	AUT	The device is auto-tuning.
h3	SIM	The device is in the simulation mode.

(Tips)

- If the function is displayed, it means that the device is in the special state.

## ■ List of monitor screen numbers

No	Name	Screen number
1	Three-line monitor screen "Multi-monitor"	H01
2	Setting screen for rotating direction of operator keypad	H02
3	Setting screen "Concurrent monitor"	H03
4	Monitor with large characters "Big monitor"	H04
5	Selection screen for parameter code	H05
6	Trip history "Total count monitor"	H06
7	Trip currently occurring	H07
8	Detailed trip history screen	H08
9	Retry history "Why retry monitor"	H09
10	Detailed retry history screen	H10
11	Detailed screen for limitation status icon	H11
12	Home screen option	o01
13	Inverter name setting	o02
14	Selection of data displayed at the bottom center	o03
15	Menu screen	M01
16	R/W function screen	R01
17	Screen for selecting data uploaded using the R/W function	R02
18	Screen for selecting saving location for data uploaded using the R/W function	R03
19	Screen for displaying progress status of uploading using the R/W function	R04
20	Screen for selecting data downloaded using the R/W function	R05
21	Screen for selecting the location for reading data that is downloaded using the R/W function	R06
22	Screen for displaying progress status of downloading using the R/W function	R07
23	System settings screen	S01
24	Language selection screen	S02
25	Dimming setting screen	S03
26	Setting screen for automatic light off time	S04
27	Setting screen for dimming at light off	S05
28	Setting screen for automatic home transition time	S06
29	Monitor screen for basic inverter information	S07
30	Selection screen for operator initialization	S08
31	Operator version display screen	S09
32	Date and time screen	S11
33	Date and time setting screen	S12
34	Selection screen for date and time display format	S13
35	Setting screen for battery level warning	S14
36	Inverter model selection screen	S19
37	Read lock selection screen	S21
38	Selection screen for blinking at the time of trip	S22
39	Color setting screen	S23

No	Name	Screen number
40	Selection screen for self-check mode	S25 ~S35
41	Setting screen for automatic home screen	S36
42	Remote mode switching screen	S38
43	Scroll menu	L01
44	Scroll screen	L02
45	Message screen	*)

\*) If a message is displayed, see "18.5.3 Checking Display Messages".

9.2.2 Transition of Operator Keypad Screen

- Types of main monitor screen

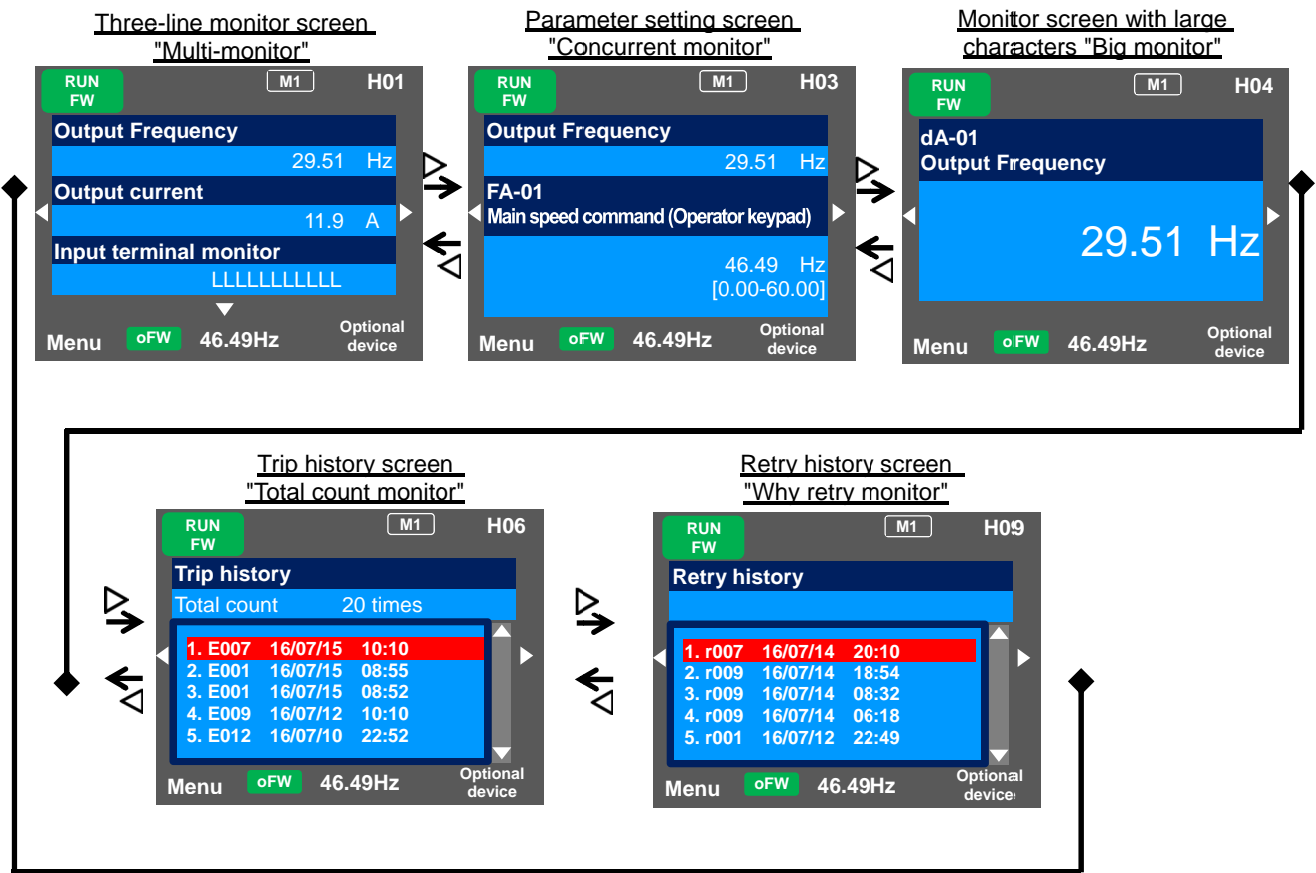

- Menu screen

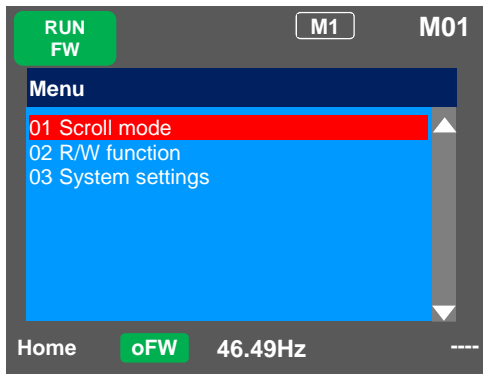

- Home screen option

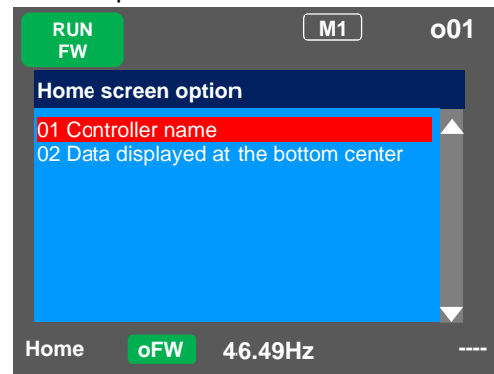

- You can switch between the main screen and menu screen using the F1(1) key.



- You can navigate to the home screen option from the main screen by using the F2(2) key. To return to the home screen, press F1(1) key.

### 9.3 Set up parameters!

#### 9.3.1 Checking the List and Configuring "Scroll Mode"



- I want to first configure settings to rotate the motor.
- To configure inverter settings, I want to change parameters.
- I want to check parameter settings all at once.



- Press F1 (Menu) key on the screen that is displayed upon power-on (Multi-monitor in the example below) to move to the system settings screen (M01).



- When configuring basic settings of motor, base frequency, rated voltage of motor, input and output of terminals, as well as when configuring individual functions, change parameters in the scroll mode.
- You can check list of setting data of parameters in the scroll mode, therefore, it is also useful when checking the settings.
- In the system settings, if the scroll screen is set to the initial screen, dA-01, dA-02, and dA-03 of the d: Monitor are initially displayed.

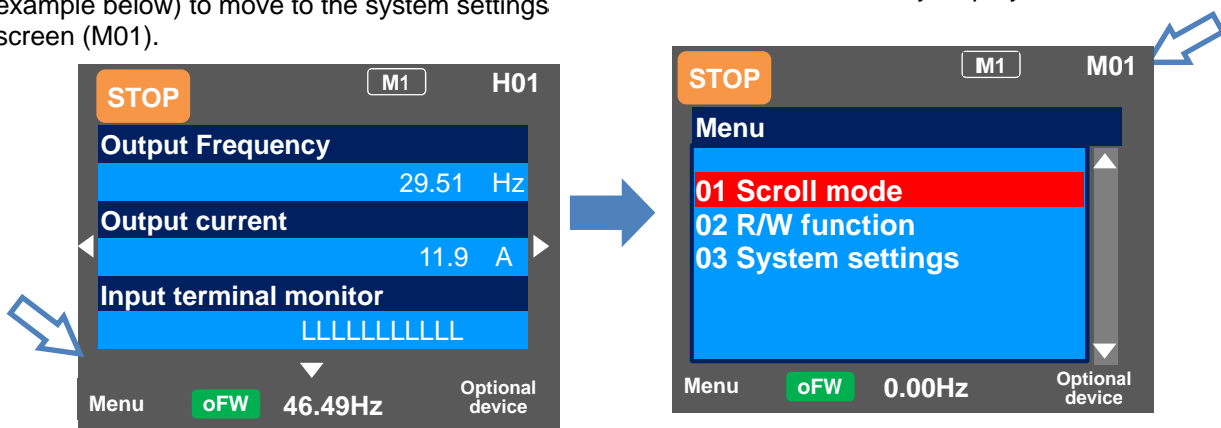

Scroll menu - Parameter selection screen

Set-up procedure	Action
	<p>3.1 Choose the scroll mode on the system settings screen (M01) and press the SEL(O) key to show the scroll menu (L01). To 3.2.</p>
	<p>3.2 Choose a group you want to browse using the up and down (<math>\Delta</math>/<math>\nabla</math>) keys, and then press the SEL(O) key to move to the parameter list display. For example, select "H: Motor control". Example: In the example shown below, the Hb group, which is a basic parameter of induction motor, is checked, and a parameter is changed. To 3.3.</p>

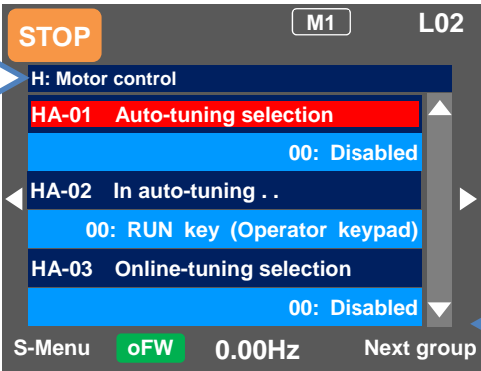
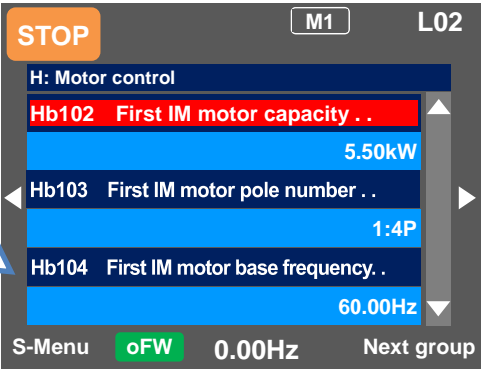
Set-up procedure	Action
	<p>3.3 Parameters of "H: Motor control" are displayed. Using the up and down (<math>\Delta \nabla</math>) keys, you can check parameters. Pressing the F2(2) key jumps to the top [Hb102] of the next group of [HA].</p> <p>(Tips) You can jump to the top parameter of the sub-group in the group ([HA], [Hb], etc. in the case of group H) using the F2(2) key (transition is performed in one direction).</p> <p>Example of group H: ...-&gt;HA-&gt;Hb-&gt;HC-&gt;Hd-&gt;HA-&gt;...</p>
	<p>3.4 Using the up and down (<math>\Delta \nabla</math>) keys, you can check parameters. Choose the parameter to change, and then press the SEL(O) key.</p> <p>Example1) [Hb103] The parameter to change the first IM motor pole number. To 3.5.</p> <p>Example2) [Hb104] The parameter to change the first IM motor base frequency. To 3.6.</p>

Example1) Change [Hb103] First IM motor pole number

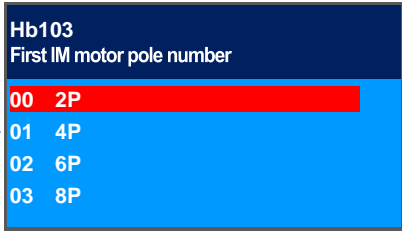
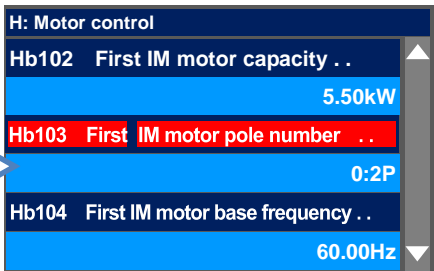
Set-up procedure	Action
	<p>3.5 If the number of motor poles is 2, using the up and down (<math>\Delta \nabla</math>) keys, adjust it to "00 2P", and then press the F2(Save) key.</p> <p>(Tips) Data is saved when the F2(2) key is pressed. It is still saved even after the device is turned off. When configuring an item, the entire screen changes to the screen for setting the item. When not saving the setting after changing it, press the F1(Back) key. The screen returns to the parameter list display.</p>
	<p>3.6 To confirm if the data is correctly changed, check the lower section of the parameter display. Press the F1(1) key three times to return to the monitor.</p>

Example2) Change [Hb104] First IM motor base frequency.

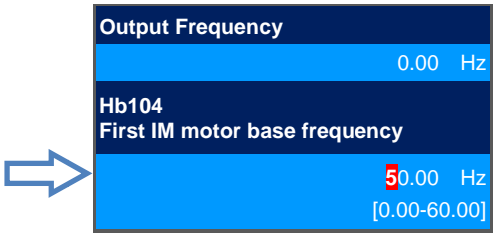
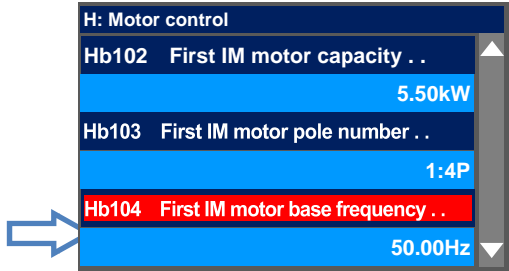
Set-up procedure	Action
	<p>3.8 You can change the right-most digit of data area. Change the value using the arrow (<math>\Delta \nabla \leftarrow \rightarrow</math>) keys, and then press the F2(2) key. To 3.9.</p> <p>(Tips) In the figure on the right, base frequency is changed to 50.00Hz. Data is saved when the F2(2) key is pressed. It is still saved even after the device is turned off. You can make adjustments while performing monitoring. The monitor on the upper area shows the parameter selected in the Big monitor.</p>
	<p>3.6 To confirm if the data is correctly changed, check the lower section of the parameter display. Press the F1(1) key three times to return to the monitor.</p>





- In the scroll mode screen (L02), (i) you can jump to the parameter at the top of each group by using the right and left (◀▶) keys or (ii) jump to the parameter at the top of the sub-group (AA, Ab, etc.) of the group by using F2(Next group) key.

- (i) You can jump to the top parameter of each group by using the right and left (◀▶) keys.  
 (...<->All parameters<->d: Monitor<->F: Command monitor/setting<->...<->U: Initial setting, PDN<-> All parameters<->...)
- (ii) You can jump to the top parameter of the sub-group in the group (AA, Ab, etc.) using the F2(Next group) key (transition is performed in one direction (see below)).  
 • Example of group A: ...->AA->Ab->AC->...->AJ->AA->...

- (i) Jump function using the right and left (◀▶) keys

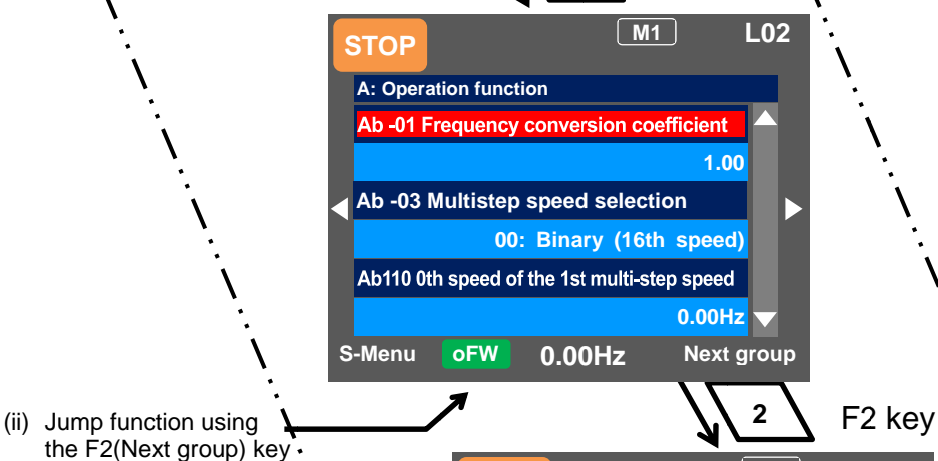
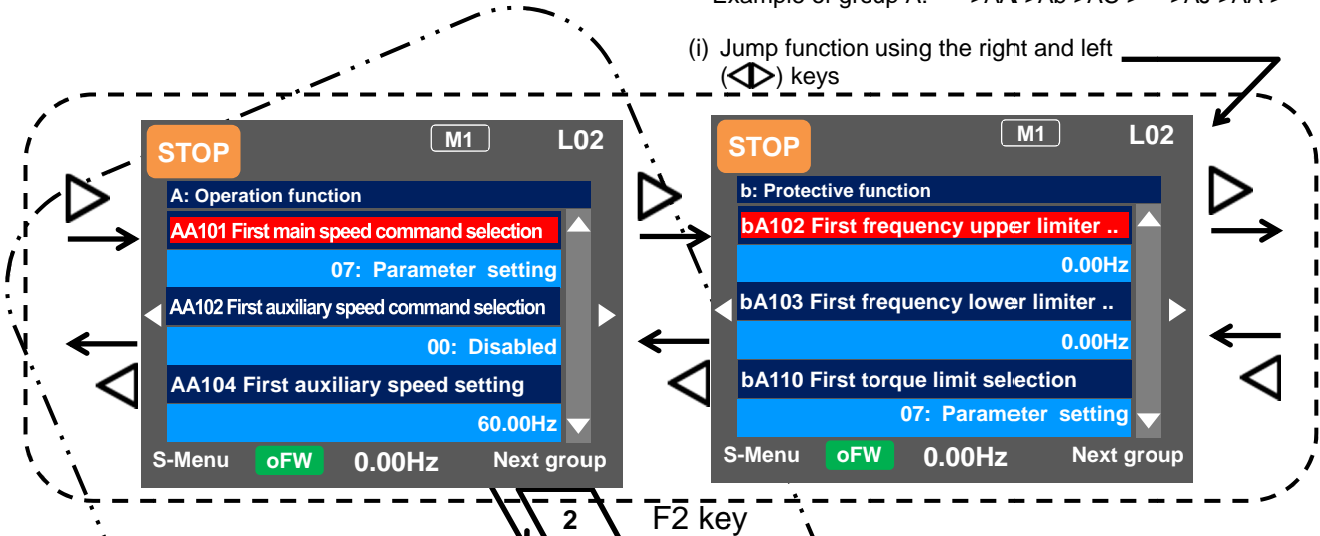

- (ii) Jump function using the F2(Next group) key

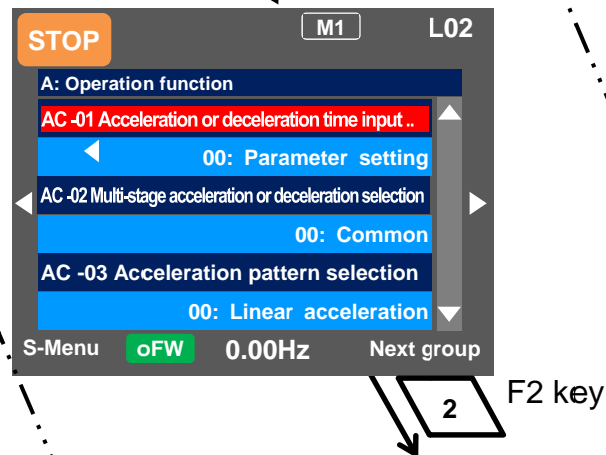

**9.3.2** Changing a Parameter While Watching a Monitor "Concurrent Monitor"



- To control the inverter operation, I want to change a parameter while monitoring the operation.



- On the screen that is displayed upon power-on, using the right and left (◀▶) keys, navigate to a setting screen "Concurrent monitor" (H03).

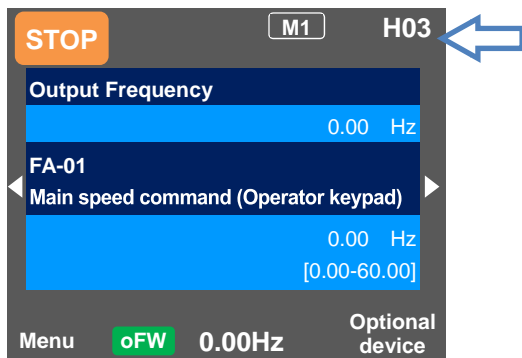

- When configuring settings such as frequency command and acceleration/deceleration time while watching the monitor during operation, you can change the settings on this monitor screen.
- On the setting screen "Concurrent monitor", you can change parameters while watching the monitor. For details of the monitor, see "9.4.2 Monitoring of Setting Screen "Concurrent Monitor".



- In the case of a parameter that requires selection of an item, the screen changes to the item selection screen.

Monitor screen - Parameter selection screen

Set-up procedure	Action
	3.1 Press the SEL(O) key to change the color of parameter field. To 3.2. (Tips) Using the up and down (Δ▽) keys, you can choose to change the parameter or change the monitor.
	3.2 When the SEL(O) key is pressed again, the leftmost letter of the parameter can be changed. To 3.3.
	3.3 Using the arrow (Δ▽◀▶) keys to change the parameter number that you want to change, and then press the SEL(O) key. Example1) When the frequency command destination [AA101] First speed command selection is changed. To 3.4. Example2) When the frequency command value is controlled in [FA-01] while the frequency command destination is set to 07: Parameter setting. To 3.7.

Example1) Change the [AA101] First main speed command selection to [Ai1] terminal.

\* The [Ai1] terminal is an analog input terminal (voltage/current).

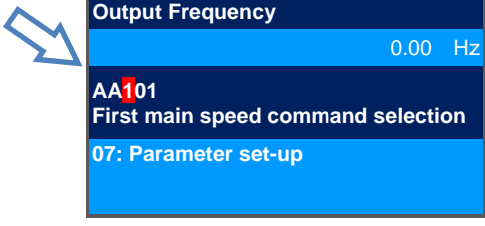
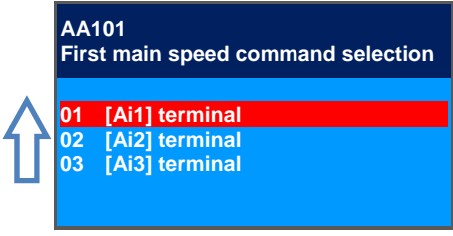
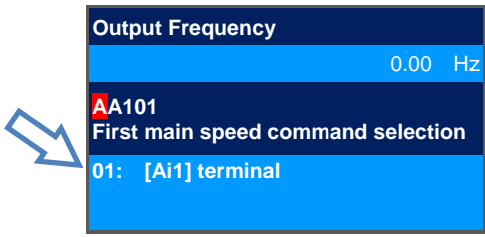
Set-up procedure	Action
	<p>3.4 Press the SEL(O) key while [AA101] is displayed. To 3.5.</p> <p>(Tips) The information currently selected is shown in the lower section. "07: Parameter setting" is currently selected.</p>
	<p>3.5 Using the up and down (<math>\Delta</math><math>\nabla</math>) keys, select "01 [Ai1] terminal", and then press the F2(2) key. To 3.6.</p> <p>(Tips) Data is saved when the F2(2) key is pressed. It is still saved even after the device is turned off. When configuring an item, the entire screen changes to the screen for setting the item.</p>
	<p>3.6 To confirm if the data is correctly changed, check the lower section. Press the F1(1) key to return to the monitor.</p> <p>(Tips) The information currently selected is shown in the lower section. "01 [Ai1] terminal" is currently selected.</p>

Example2) Change frequency command in [FA-01].  
(If the frequency command selection is "07: Parameter setting")

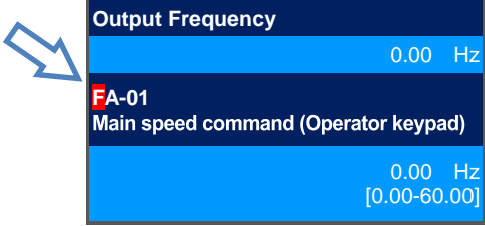
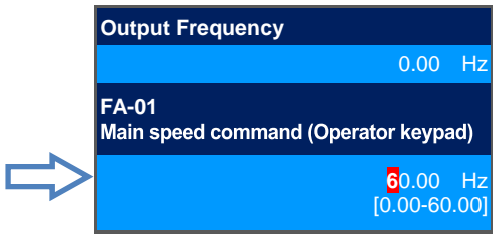
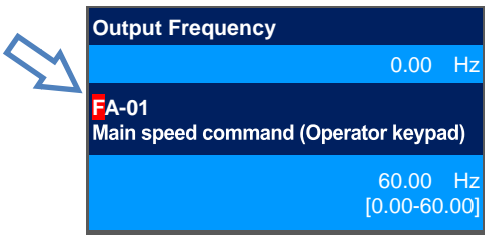
Set-up procedure	Action
	<p>3.7 Press the SEL(O) key while [FA-01] is displayed. To 3.8.</p> <p>(Tips) In [FA-01], the set value can be changed if the string inside ( ) of main speed command indicates the operator keypad or multi-step speed. In other cases, it is set to the command monitor.</p>
	<p>3.8 You can change the right-most digit of data. Change the value using the arrow (<math>\Delta</math><math>\nabla</math><math>\leftarrow</math><math>\rightarrow</math>) keys, and then press the F2(2) key. To 3.9.</p> <p>(Tips) In the figure on the right, base frequency is changed to 60.00Hz. Data is saved when the F2(2) key is pressed. It is still saved even after the device is turned off. You can make adjustments while performing monitoring.</p>
	<p>3.9 To confirm if the data is correctly changed, check the lower section. Press the F1(1) key to return to the monitor.</p> <p>(Tips) The current frequency command is shown in the lower section. Currently, 60.00Hz is input as the command.</p>

### 9.4 Monitor Inverter Information!

#### 9.4.1 Three-Line Monitor Screen "Multi-Monitor".



• I want to monitor multiple data at the same time.



• What is displayed on the first line of three-line monitor screen "Multi-monitor" (H01) is the same as that displayed on the upper area of the setting screen "Concurrent monitor" (H03) and the screen with large characters, "Big monitor" (H04).



• On the screen that is displayed upon power-on, using the right and left (◀▶) keys, navigate to "H01".



• In the three-line monitor screen, you can monitor three types of information at the same time. You can change and save the monitored data.

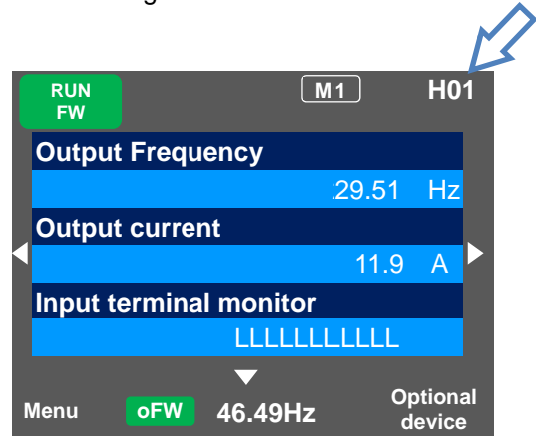

Example) Change the output current monitor to the input power monitor.

Set-up procedure	Action
	4.1.1 Press the SEL(O) key to change the color of the field in upper section. Using the up and down (Δ▽) keys, navigate to the second line. To 4.1.2
	4.1.2 When the SEL(O) key is pressed, the left-most letter of the parameter can be changed. To 4.1.3
	4.1.3 Using the arrow (Δ▽◀▶) keys, change [dA-02] to [dA-30]. To 4.1.4
	4.1.4 Press the SEL(O) key to confirm the monitoring target. Press the F1(1) key to return to the monitor.

9.4.2 Setting Screen "Concurrent Monitor"



- I want to change the monitor used when changing a parameter while performing monitoring.



- What is displayed on the upper monitor of the setting screen "Concurrent monitor" (H03) is the same as that displayed on the first line of three-line monitor screen "Multi-monitor" (H01) and the screen with large characters, "Big monitor" (H04).



- On the screen that is displayed upon power-on, using the right and left (◀▶) keys, navigate to "H03".



- On the setting screen, you can control parameter data while performing monitoring. To change the selected data, the screen changes to the setting screen that shows options.

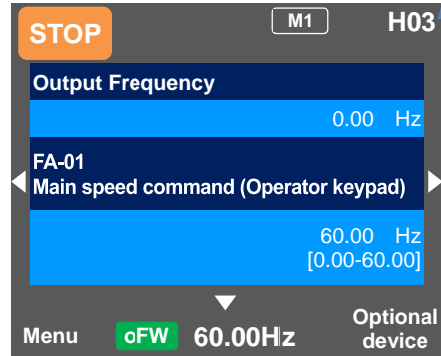

Example) Change the output frequency monitor to the PID1 output monitor.

Set-up procedure	Action
	4.2.1 Press the SEL(O) key to change the color of parameter field. Using the up and down (Δ∇) keys to select and navigate to the detail of monitoring. To 4.2.2
	4.2.2 When the SEL(O) key is pressed, the left-most letter of the parameter can be changed. To 4.2.3
	4.2.3 Using the arrow (Δ∇◀▶) keys, change [dA-01] to [db-50]. To 4.2.4
	4.2.4 Press the SEL(O) key to confirm the monitoring target, which is then displayed in the upper section. Press the F1(1) key to return to the monitor. You can also configure parameters using the up and down (Δ∇) keys .

**9.4.3** Monitor with Large Characters "Big Monitor"



• I want to perform monitoring with numeric values displayed in larger size.



• In the monitor screen with large characters, you can display a parameter in bigger size.



• What is monitored on the screen with large characters, "Big monitor" (H04) is the same as the upper monitor of the setting screen "Concurrent monitor" (H03) and the first line of three-line monitor screen "Multi-monitor" (H01).



• On the screen that is displayed upon power-on, using the right and left (◀▶) keys, navigate to "H04".

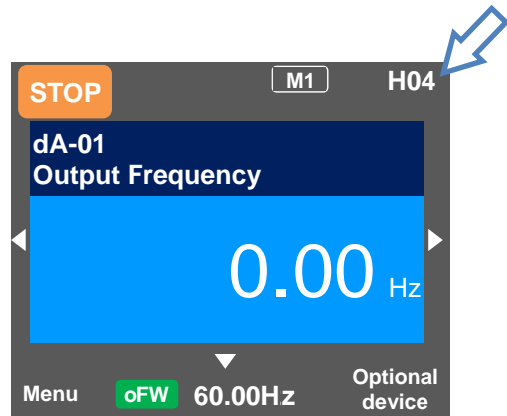

Example) Change the output frequency monitor to the integrated input power monitor.

Set-up procedure	Action
	4.3.1 When the SEL(O) key is pressed, the left-most letter of the parameter can be changed. To 4.3.2
	4.3.2 Using the arrow (Δ▽◀▶) keys, change [dA-1] to [dA-32]. Press the SEL(O) key to confirm and return to the monitor.

## 9.5 Check Error History!

### 9.5.1 Trip History "Total Count Monitor"



• I want to check trip history.



- To display time in trip history, you need to configure clock settings.
- To use the clock function, you need an optional battery that is separately sold.



• On the screen that is displayed upon power-on, using the right and left (◀▶) keys, navigate to "H06".



- The trip history screen "Total monitor" shows details of the errors that have occurred and the total number of times trip occurred.
- For details of errors, see "Chapter 18 Tips/FAQ/Troubleshooting".

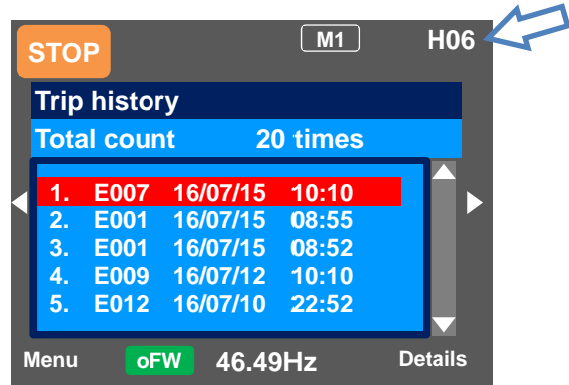

Set-up procedure	Action
	5.1.1 Using the up and down (Δ∇) keys, select history information you want to check. To 5.1.2
	5.1.2 Press the SEL(O) key to show details of the selected history information. To 5.1.3
	5.1.3 Using the up and down (Δ∇) keys, you can check details. Press the F1(1) key to return to the monitor.

9.5.2 Retry History "Why Retry Monitor"



• I want to check retry history.



- To display time in retry history, you need to configure clock settings.
- To use the clock function, you need an optional battery that is separately sold.



• On the screen that is displayed upon power-on, using the right and left (◀▶) keys, navigate to "H09".



- The retry history screen "Why retry monitor" shows details of the errors that have occurred and the total number of times retry was performed.
- For details of errors, see "Chapter 18 Tips/FAQ/Troubleshooting".

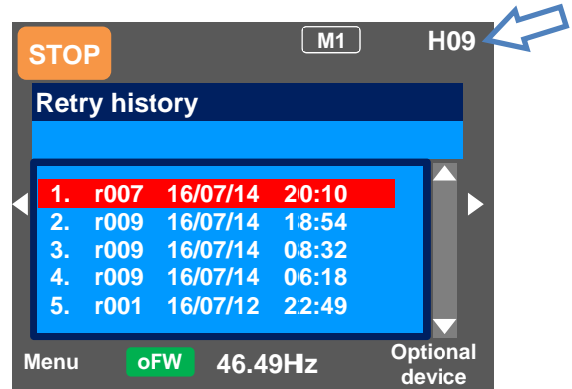

Set-up procedure	Action
	5.2.1 Using the up and down (Δ▽) keys, select history information you want to check. To 5.2.2
	5.2.2 Press the SEL(O) key to show details of the selected history information. To 5.2.3
	5.2.3 Using the up and down (Δ▽) keys, you can check details. Press the F1(1) key to return to the monitor.



## 9.6 Copy Data!

### 9.6.1 READ Function



- I want to back up inverter data on the operator keypad just in case.
- I want to retrieve data to migrate settings to another inverter.



- On the screen that is displayed upon power-on, press the F1(1) key to navigate to the menu screen "M01". Then, select the R/W function by pressing the SEL(O) key.



- With R/W function, you can read and write data.
- Only a set of data can be saved.

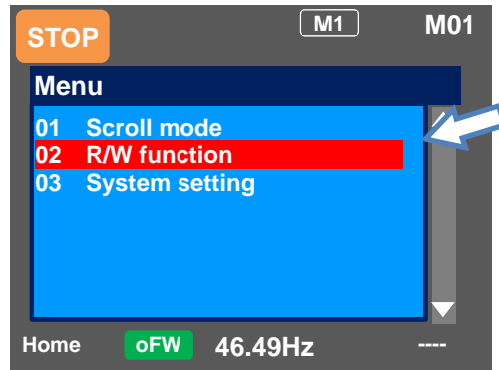

Set-up procedure	Action
	6.1.1 Press the SEL(O) key to confirm the READ function. To 6.1.2
	6.1.2 Select data to be read by using the up and down (Δ∇) keys. Then, confirm the function by pressing the SEL(O) key. To 6.1.3
	6.1.3 In accordance with the instruction shown on the screen, specify the location of data you to be saved, and press the F2(2) key to navigate to the confirmation screen. Then, press the F2(2) key to start reading the data. When the completion screen appears, the procedure is complete.  Display description: No. Date Time Inverter name: No. Data type * Inverter name: No. is unique to SJ-P1. * Data type is 1: Only parameters or 2: Parameters+EzSQ. * To display date and time, you need to configure clock settings from System settings.

\* If you cannot read data, see "9.13.1 Disabling Data R/W".

9.6.2 WRITE Function



- I want to write data to migrate settings to another inverter.
- I want to rewrite data that was read.



- On the screen that is displayed upon power-on, press the F1(1) key to navigate to the menu screen "M01". Then, select the R/W function by pressing the SEL(O) key.



- With R/W function, you can read and write data.

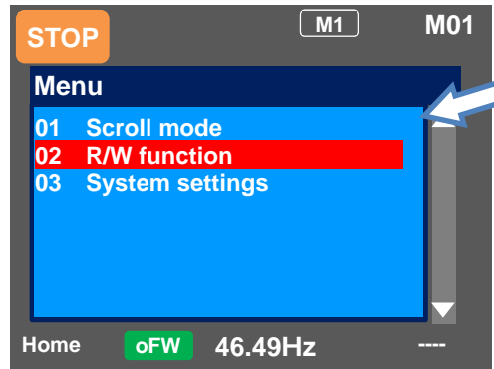

Set-up procedure	Action
	6.2.1 Select the write function by using the up and down ( $\Delta$ / $\nabla$ ) keys. Then, confirm by pressing the SEL(O) key. To 6.2.2
	6.2.2 Select data to be written by using the up and down ( $\Delta$ / $\nabla$ ) keys. Then, confirm the function by pressing the SEL(O) key. To 6.2.3
	6.2.3 In accordance with the instruction shown on the screen, select data to be written to the inverter, and press the F2(2) key to start writing. When the completion screen appears, the procedure is complete. Display description: No. Date Time Inverter name: No. Data type * Inverter name: No. is unique to SJ-P1. * Data type is 1: Only parameters or 2: Parameters+EzSQ. * To display date and time, you need to configure clock settings from System settings.

\* If you cannot write data, see "9.13.1 Disabling Data R/W".

## 9.7 System Settings!



- I want to change settings of the operator keypad.
- I want to initialize settings of the operator keypad.



- On the screen that is displayed upon power-on, press the F1(1) key to navigate to the menu screen "M01". Then, select the R/W function by pressing the SEL(O) key or right (▶) key.

No.	Name	Tips
01	Language selection	Changes the language setting.
02	Dimming	Controls the brightness of operator keypad screen.
03	Automatic light off time*1)	Controls the time to automatically light off the screen.
04	Dimming at light off *1	Controls the brightness when the screen is automatically lit off.
05	Automatic home transition time	Sets the time to automatically return to the home screen.
06	Initial home screen selection	Sets the screen that is displayed upon power-on and automatic return to the home screen.
07	Read lock	Limits the reading of data.
08	Blinking during trip	Sets whether blinking is performed or not during trip.
09	Date and time*2)	Configures settings of time, display format, and battery level warning.
10	Battery level warning	Displays a warning message when the battery runs out.
11	Color setting	Sets the background color.
12	Basic inverter information monitor	Checks information of the main unit.
13	Selection of connected model	Sets SJ-P1.
14	Operator keypad version	Displays the version of the operator keypad.
15	Initialization of operator keypad	Initializes the operator keypad.
16	Self-check mode	Operates self-check mode.
17	Remote mode switching	If this setting is enabled, when the F1 key on the home screen is pressed for 1 second or more, you can switch the frequency command and operation command to commands issued from the operator keypad.
18	Reserve	Do not change the setting from OFF.

\*1) The light off function is disabled until trip is canceled after the occurrence of trip. For details, see the User's Guide.

\*2) To use the clock function, you need an optional battery that is separately sold.  
Recommended product: Hitachi Maxell, Ltd. CR2032, 3V  
If no electricity is supplied to the inverter, battery replacement is required every two years.



- On the System settings screen, you can use extended functions.

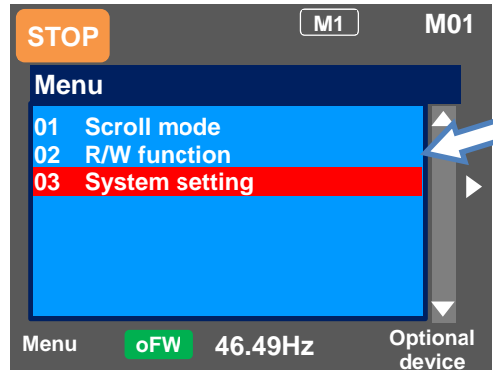

- If there is an error in the memory area in the operator keypad, an error message is displayed on the operator keypad. In such a case, initialize the operator keypad from the System settings, and confirm the settings. If the error on the operator keypad is not solved, the internal memory may be damaged. You need to replace the operator keypad.

### Battery replacement of the operator keypad VOP



- The battery used for clock function is not included with this device. Prepare CR2032 as necessary.
- When battery is changed, the clock data is initialized, therefore, you need to configure the setting again.
- Even if the battery runs out, data in VOP (read parameters and EzSQ program) are retained.

### Disposal of battery of the operator keypad VOP



- Disposal of the operator keypad VOP or battery that is no longer needed may subject to regulations of your municipalities. Dispose of them in accordance with regulations of respective municipalities. Insulate the battery using a tape or other materials when disposing of it.



- Care must be taken in export of an operator keypad VOP equipped with a battery.
- When products equipped with lithium primary battery (including all manganese dioxide lithium coin batteries and heat-resistant manganese dioxide lithium coin batteries) are exported to or transferred via California in the U.S., it is obliged to mark the following sentences in the packaging case, individual packages, and instruction manuals.

**Perchlorate Material - special handling may apply.  
See [www.dtsc.ca.gov/hazardouswaste/perchlorate](http://www.dtsc.ca.gov/hazardouswaste/perchlorate)**

- When you export your products equipped with the operator keypad VOP to California in the U.S., please mark the indications shown above on the packaging case such as external box and transportation box of your product.



- Follow the following steps to replace the battery.
  - (i) Check the inverter is turned off and the POWER lamp on the operator keypad is off.
  - (ii) Remove the operator keypad VOP from the main unit. When removing the operator keypad, hold the front cover.
  - (iii) Open the cover of the operator keypad VOP, which is on the back side, and then insert the battery. Make sure that you can see the + side when inserting the battery.
  - (iv) Close the cover, and install the operator keypad VOP in the inverter again.



- As batteries are subject to leakage, explosion, heat generation, and fire, do not short circuit + and - terminals, charge, disassemble, heat, expose to fire, or apply a strong impact.



**Prohibited**

- If a strong impact is accidentally applied to them (e.g., dropped on the floor), do not use the battery because they may have leakage.



**Do**

- It is defined by the UL standard that battery replacement must be performed by a skilled technician. Please assign a skilled technician to perform the replacement work.
- If you cannot see what is displayed on the operator keypad VOP because the service life is near its end, replace the operator keypad VOP.

### 9.8 Change Assist Bar Information!



- I want to change the frequency command displayed on the assist bar to inverter name.
- I want to display current time on the assist bar.



- On the screen that is displayed upon power-on, press the F2(2) key to navigate to the option screen "o01". Then, select data that is shown at the bottom center by pressing the SEL(O) key. After selecting data, save it by pressing the F2(2) key.



- By selecting the F2(2) key option from the home screen, you can change the content of display of status bar.

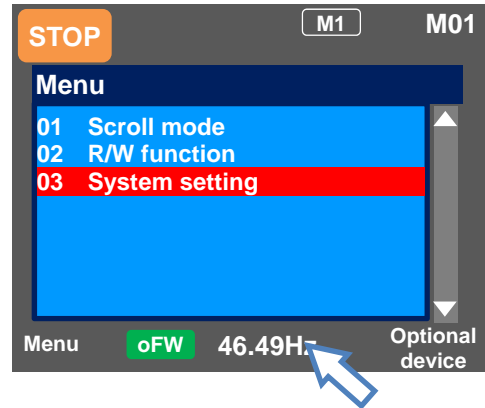

Option		Tips
01 Controller (inverter) name		You can specify 8-digit string from alphanumeric letters and symbols.
02 Data displayed at the bottom center	00 Frequency command	The current frequency command is displayed.
	01 Torque command	The current torque command is displayed (during torque control).
	02 Time	The current time is displayed.
	03 Controller name	The specified controller (inverter) name is displayed.

## 9.9 Supplementary Information

### ■ Back to the home monitor

Q

- I want to go back to the home monitor.

A

- Press the F1 key repeatedly to go back to the home monitor. When home is shown above the F1 key, you can go back to the home monitor, and navigate through the home monitor using the right and left keys.

### ■ I want to delete saved data that I read.

Q

- I want to delete saved data that I read using the read function.

A

- By performing initialization of the operator keypad on the System settings screen, you can delete data that is saved using the read function. However, note that the settings of the operator keypad are also initialized.

### ■ Display (B) Details of warning status display

Q

- I see icons with "NRDY", "LIM", and "ALT", but I don't know what they mean.

A

- When the up key is pressed while a monitor screen other than the trip history "Total monitor" is displayed, the screen changes to the monitor where you can check the current status. Press the SEL(O) key, down key, and F1 key to go back.

### ■ Switch between normal/reverse rotations on the operator keypad

Q

- I want to switch between the normal rotation and reverse rotation on the operator keypad in a simple manner.

A

- By pressing the down key on the three-line monitor screen "Multi-monitor", you can specify F1 (normal rotation) or F2 (reverse rotation). To go back to the monitor, press the up key.

## 9.10 Parameter Functions

### 9.10.1 Protecting Parameters (Prohibiting Change)

**Q**

- I want to protect a parameter value that I changed.
- I do not want anyone to change the setting without permission.

**A**

- By configuring the soft-lock function [UA-16] and [UA-17], you can prevent parameters from being changed.
- While soft-lock function is enabled, the LKS mark (Lock State mark) is shown on the right of parameters.

**A**

- By configuring the soft-lock function [UA-16] and [UA-17], you can prevent parameters from being changed.
- While soft-lock function is enabled, the LKS mark (Lock State mark) is shown on the right of parameters.

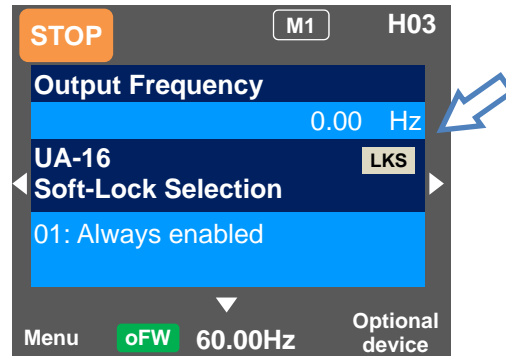

**Parameter**

Item	Parameter	Data	Description
Soft-lock selection	[UA-16]	00	When the soft-lock terminal [SFT] is on, data set to [UA-17] other than [UA-16] are locked.
		01	After the setting is performed, data set to [UA-17] other than [UA-16] are locked.
Soft-lock target selection	[UA-17]	00	All data other than [UA-16] and [UA-17] cannot be changed
		01	Data other than [UA-16] and [UA-17] and set frequency cannot be changed
Input terminal selection	[CA-01]~ [CA-11]	036	[SFT]: Used when the soft-lock function is used on terminals.

### 9.10.2 Limiting Displayed Parameters

**Q**

- I want to display only the necessary parameters.
- I want to hide parameters not in use as much as possible.
- I want to display only parameters that have been changed.

**A**

- You can change the content of display on the operator keypad according to your purpose.
- To know which parameters are changed, you can check by setting [UA-10] to 03.
- If you do not want to display parameters for functions not in use, you can reduce them by setting [UA-10] to 01.

#### Parameter

Item	Parameter	Data	Description
Display selection	[UA-10]	00	All parameters are displayed.
		01	Parameters are displayed by function. Disabled functions are not displayed with some exceptions.
		02	Display is performed in accordance with the settings configured by the user. Parameters set to [UA-31] to [UA-62] are displayed with some exceptions.
		03	Parameters that have been changed from the factory default settings and some other parameters are displayed.
		04	Monitor parameters and some other parameters are displayed.
Selection of second setting parameter display	[UA-21]	00	Hides parameters of second setting [**2**].
		01	Displays parameters of second setting [**2**].
Selection of whether to display option parameter	[UA-22]	00	Hides parameters that start with o.
		01	Displays parameters that start with o.
User parameter selection	[UA-31]	255	No assignment
	~ [UA-62]	*****	Choose the code you want to display. (all codes are subjected)

**A**

- If you are not using the input terminal function [SET] for switching to the second setting, by setting [UA-21] to 00, you can reduce a great number of displayed items.
- If you are not using option cassettes, by setting [UA-22] to 00, you can reduce indications for option cassettes.



### ■ (1) Function-specific display: [UA-10]=01

- If a function is not selected, parameters related to the function are hidden.

#### (i) IM control parameters

Display condition: AA121≤10 or AA221≤10

Parameter	Name
Hb*02	* selection of the IM motor capacity
Hb*03	* selection of the IM motor pole number
Hb*04	* IM base frequency
Hb*05	* IM maximum frequency
Hb*06	* IM motor rated voltage
Hb*08	* IM motor rated current
Hb*10	* IM motor constant R1
Hb*12	* IM motor constant R2
Hb*14	* IM motor constant L
Hb*16	* IM motor constant lo
Hb*18	* IM motor constant J
Hb*30	* minimum frequency (V/f, A.bst, IM-SLV)
Hb*31	* reduced voltage start time (V/f)
Hb*40	* selection of operation mode for manual torque boost
Hb*41	* volume of manual torque boost (V/f)
Hb*42	* break point of manual torque boost (V/f)
Hb*45	* selection of energy-saving operation (V/f)
Hb*46	* energy-saving response/accuracy adjustment (V/f)
Hb*50	* free V/f frequency 1
Hb*51	* free V/f voltage 1
Hb*52	* free V/f frequency 2
Hb*53	* free V/f voltage 2
Hb*54	* free V/f frequency 3
Hb*55	* free V/f voltage 3
Hb*56	* free V/f frequency 4
Hb*57	* free V/f voltage 4
Hb*58	* free V/f frequency 5
Hb*59	* free V/f voltage 5
Hb*60	* free V/f frequency 6
Hb*61	* free V/f voltage 6
Hb*62	* free V/f frequency 7
Hb*63	* free V/f voltage 7
Hb*70	* slip compensation P gain with sensor (V/f, A.bst)
Hb*71	* slip compensation I gain with sensor (V/f, A.bst)
Hb*80	* output voltage gain (V/f)
HC*01	* voltage compensation gain of automatic torque boost
HC*02	* slip compensation gain of automatic torque boost
HC*10	* 0th speed range limiter (IM-0Hz-SLV)
HC*11	* amount of boost at the start (IM-SLV, IM-CLV)
HC*12	* amount of boost at the start (IM-0Hz-SLV)
HC*13	* selection of whether a secondary-resistance correction is to be conducted (IM-SLV, IM-0Hz-SLV, IM-CLV)
HC*14	* selection of reversal prevention (IM-SLV, IM-0Hz-SLV, IM-CLV)
HC*20	* time constant for torque current command filter
HC*21	* speed feed forward compensation adjustment gain

- For more information about the display condition, see the table below.
- The \* mark in the table is replaced by 1 or 2. (1 represents first and 2 represents second.)

#### (ii) SM (PMM) control parameters

Display condition: AA121>10 or AA221>10

Parameter	Name
Hd*02	* SM(PMM) motor capacity selection
Hd*03	* SM(PMM) motor poles selection
Hd*04	* SM(PMM) base frequency
Hd*05	* SM(PMM) maximum frequency
Hd*06	* SM(PMM) motor rated voltage
Hd*08	* SM(PMM) motor rated voltage
Hd*10	* SM(PMM) motor constant R
Hd*12	* SM(PMM) motor constant Ld
Hd*14	* SM(PMM) motor constant Lq
Hd*16	* SM(PMM) motor constant Ke
Hd*18	* SM(PMM) motor constant J
Hd*30	* SM(PMM) lowest frequency (switch) (SM-SLV, SM-IVMS)
Hd*31	* SM no-load current (SM-SLV, SM-IVMS)
Hd*32	* SM start method selection (SM-SLV, SM-IVMS, SM-CLV)
Hd*33	* SM initial position estimation Zero-V stand-by times (SM-SLV, SM-IVMS, SM-CLV)
Hd*34	* SM initial position estimation Detection stand-by times (SM-SLV, SM-IVMS, SM-CLV)
Hd*35	* SM initial position estimation Detection times (SM-SLV, SM-IVMS, SM-CLV)
Hd*36	* SM initial position estimation Voltage gain (SM-SLV, SM-IVMS, SM-CLV)
Hd*37	* SM initial position estimation Magnetic-pole position offset
Hd-41	IVMS carrier frequency
Hd-42	Filter gain of IVMS detection current
Hd-43	Open-phase voltage detection gain selection SM(PMM)-IVMS
Hd-44	Selection of open-phase switch threshold correction SM(PMM)-IVMS
Hd-45	Speed control P gain SM(PMM)-IVMS
Hd-46	Speed control I gain SM(PMM)-IVMS
Hd-47	Waiting time for open-phase switching SM(PMM)-IVMS
Hd-48	Restriction on the rotation-direction determination SM(PMM)-IVMS
Hd-49	Timing adjustment for open-phase voltage detection SM(PMM)-IVMS
Hd-50	Minimum pulse range adjustment SM(PMM)-IVMS
Hd-51	Current limit of IVMS threshold
Hd-52	IVMS threshold gain
Hd-58	IVMS carrier-frequency switching start/finish point

## (iii) Position control parameters

Display condition: AA123≠00 or AA223≠00

Parameter	Name
AE-01	Electronic gear installation position selection
AE-02	Numerator of electronic gear ratio
AE-03	Denominator of electronic gear ratio
AE-04	Positioning completion range setting
AE-05	Positioning completion delay time setting
AE-06	Positioning control feed forward
AE-07	Position loop gain

## (iv) Orientation

Display condition: AA123=01 or AA223=01

Parameter	Name
AE-08	Position bias volume
AE-10	Orientation stop position for input destination selection
AE-11	Orientation stop position
AE-12	Orientation speed setting
AE-13	Orientation direction setting

## (v) Absolute position control

Display condition: AA123&gt;01 or AA223&gt;01

Parameter	Name
AE-20~50	Position command 0-15
AE-52	Position range designation (forward rotation side)
AE-54	Position range designation (reverse rotation side)
AE-56	Positioning mode selection
AE-60	Teaching selection
AE-61	Memorization of current position at power-off
AE-62	Preset position data
AE-64	Gain for calculating the deceleration stop distance
AE-65	Bias for calculating the deceleration stop distance
AE-66	APR control speed limit
AE-67	APR start speed
AE-70	Zero return mode selection
AE-71	Zero return direction selection
AE-72	Low speed zero return speed
AE-73	High speed zero return speed

## (vi) Normal acceleration/deceleration speed

Display condition: AC-02=00

Parameter	Name
AC*15	* 2-stage acceleration/deceleration selection
AC*16	* 2-stage acceleration frequency
AC*17	* 2-stage deceleration frequency
AC*20	* acceleration time 1
AC*22	* deceleration time 1
AC*24	* acceleration time 2
AC*26	* deceleration time 2

## (vii) Multi-stage acceleration/deceleration

Display condition: AC-02=01

Parameter	Name
AC-30	Acceleration time for multi-speed 1st speed
AC-32	Deceleration time for multi-speed 1st speed
AC-34	Acceleration time for multi-speed 2nd speed
AC-36	Deceleration time for multi-speed 2nd speed
AC-38	Acceleration time for multi-speed 3rd speed
AC-40	Deceleration time for multi-speed 3rd speed
AC-42	Acceleration time for multi-speed 4th speed
AC-44	Deceleration time for multi-speed 4th speed
AC-46	Acceleration time for multi-speed 5th speed
AC-48	Deceleration time for multi-speed 5th speed
AC-50	Acceleration time for multi-speed 6th speed
AC-52	Deceleration time for multi-speed 6th speed
AC-54	Acceleration time for multi-speed 7th speed
AC-56	Deceleration time for multi-speed 7th speed
AC-58	Acceleration time for multi-speed 8th speed
AC-60	Deceleration time for multi-speed 8th speed
AC-62	Acceleration time for multi-speed 9th speed
AC-64	Deceleration time for multi-speed 9th speed
AC-66	Acceleration time for multi-speed 10th speed
AC-68	Deceleration time for multi-speed 10th speed
AC-70	Acceleration time for multi-speed 11th speed
AC-72	Deceleration time for multi-speed 11th speed
AC-74	Acceleration time for multi-speed 12th speed
AC-76	Deceleration time for multi-speed 12th speed
AC-78	Acceleration time for multi-speed 13th speed
AC-80	Deceleration time for multi-speed 13th speed
AC-82	Acceleration time for multi-speed 14th speed
AC-84	Deceleration time for multi-speed 14th speed
AC-86	Acceleration time for multi-speed 15th speed
AC-88	Deceleration time for multi-speed 15th speed

## (viii) Internal current braking

Display condition: AF\*01=01, 02

Parameter	Name
AF*02	* braking mode
AF*03	* DC braking frequency
AF*04	* DC braking delay time
AF*05	* DC braking force at the time of the stop
AF*06	* DC braking time at the time of the stop
AF*07	* DC current braking trigger selection
AF*08	* DC braking force at the start
AF*09	* DC braking time at the start

## (ix) Brake control 1 (common to forward/reverse)

Display condition: AF\*30=01, 02

Parameter	Name
AF*31	* brake release establishment waiting time
AF*32	* acceleration waiting time
AF*33	* stop waiting time
AF*34	* brake check waiting time
AF*35	* brake release frequency
AF*36	* brake release current
AF*37	* brake apply frequency

## (x) Brake control 1 (forward/reverse set individually)

Display condition: AF\*30=02

Parameter	Name
AF*38	* brake release establishment waiting time (reverse rotation side)
AF*39	* acceleration waiting time (reverse rotation side)
AF*40	* stop waiting time (reverse rotation side)
AF*41	* brake check waiting time (reverse rotation side)
AF*42	* brake release frequency (reverse rotation side)
AF*43	* brake release current (reverse rotation side)
AF*44	* brake apply frequency (reverse rotation side)

## (xi) Brake control 2

Display condition: AF\*30=03

Parameter	Name
AF*50	* brake release delay time
AF*51	* brake apply delay time
AF*52	* brake check time
AF*53	* servo lock time at start
AF*54	* servo lock time at stop

## (xii) Free electronic thermal

Display condition: bc\*11=02

Parameter	Name
bC*20	* free electronic thermal frequency 1
bC*21	* free electronic thermal current 1
bC*22	* free electronic thermal frequency 2
bC*23	* free electronic thermal current 2
bC*24	* free electronic thermal frequency 3
bC*25	* free electronic thermal current 3

## (xiii) Gain mapping 1

Display condition: HA\*20=00

Parameter	Name
HA*21	* gain switch time
HA*27	* gain mapping P control P gain 1
HA*30	* gain mapping P control P gain 2

## (xiv) Gain mapping 2

Display condition: HA\*20=01

Parameter	Name
HA*22	* gain switch intermediate speed 1
HA*23	* gain switch intermediate speed 2
HA*24	* gain mapping maximum frequency
HA*31	* gain mapping P gain 3
HA*32	* gain mapping I gain 3
HA*33	* gain mapping P gain 4
HA*34	* gain mapping I gain 4

## (xiv) Instantaneous power failure non-stop

Display condition: bA-30≠00

Parameter	Name
bA-31	Instantaneous power failure non-stop Function triggering voltage
bA-32	Instantaneous power failure non-stop Target level
bA-34	Instantaneous power failure non-stop Deceleration time
bA-36	Instantaneous power failure non-stop Deceleration start range
bA-37	Instantaneous power failure non-stop Constant DC voltage control P gain
bA-38	Instantaneous power failure non-stop Constant DC voltage control I gain

## (xv) Overvoltage suppression

Display condition: bA\*40≠00

Parameter	Name
bA*41	* overvoltage suppression level setting
bA*42	* overvoltage suppression operating time
bA*44	* constant DC voltage control P gain
bA*45	* constant DC current control I gain

## (xvi) Overexcitation deceleration

Display condition: bA\*46≠00

Parameter	Name
bA*47	* overexcitation output filter time constant (V/f)
bA*48	* overexcitation voltage gain (V/f)
bA*49	* overexcitation suppression level setting (V/f)

## (xvii) PID1

Display condition: AH-01=01, 02

Parameter	Name
db-30	PID1 feedback data 1 monitor
db-32	PID1 feedback data 2 monitor
db-34	PID1 feedback data 3 monitor
db-42	PID1 target value monitor (after calculation)
db-44	PID1 feedback data monitor (after calculation)
db-50	PID1 output monitor
db-51	PID1 deviation monitor
db-52	PID1 deviation 1 monitor
db-53	PID1 deviation 2 monitor
db-54	PID1 deviation 3 monitor
db-61	PID current P gain monitor
db-62	PID current I gain monitor
db-63	PID current D gain monitor
db-64	PID feed forward monitor
FA-30	PID1 target value 1 (monitor+setting)
FA-32	PID1 target value 2 (monitor+setting)
FA-34	PID1 target value 3 (monitor+setting)
AH-02	PID1 deviation minus
AH-03	PID1 unit selection (PID1)
AH-04	PID1 scale adjustment (0%)
AH-05	PID1 scale adjustment (100%)
AH-06	PID1 scale adjustment (decimal point)
AH-07	PID1 target value 1 Input destination selection
AH-10	PID1 target value 1 Set value
AH-12	PID1 multistage target value 1
AH-14	PID1 multistage target value 2
AH-16	PID1 multistage target value 3
AH-18	PID1 multistage target value 4
AH-20	PID1 multistage target value 5
AH-22	PID1 multistage target value 6
AH-24	PID1 multistage target value 7
AH-26	PID1 multistage target value 8
AH-28	PID1 multistage target value 9
AH-30	PID1 multistage target value 10
AH-32	PID1 multistage target value 11
AH-34	PID1 multistage target value 12
AH-36	PID1 multistage target value 13
AH-38	PID1 multistage target value 14
AH-40	PID1 multistage target value 15
AH-42	PID1 target value 2 Input destination selection
AH-44	PID1 target value 2 Set value
AH-46	PID1 target value 3 Input destination 2 selection
AH-48	PID1 target value 3 Set value
AH-50	PID1 target value 1 Operator selection
AH-51	PID1 feedback data 1 Input destination selection
AH-52	PID1 feedback data 2 Input destination selection
AH-53	PID1 feedback data 3 Input destination selection
AH-54	PID1 feedback data Operator selection

## PID1 (continued)

Display condition: AH-01=01, 02

Parameter	Name
AH-60	PID1 gain switch method selection
AH-61	PID1 proportional gain 1
AH-62	PID1 integral gain 1
AH-63	PID1 differential gain 1
AH-64	PID1 proportional gain 2
AH-65	PID1 integral gain 2
AH-66	PID1 differential gain 2
AH-67	PID1 gain switch time
AH-70	PID feed forward selection
AH-71	PID1 changeable range
AH-72	PID2 excessive deviation level
AH-73	PID1 feedback comparison signal OFF level
AH-74	PID1 feedback comparison signal ON level

## (xviii) PID2

Display condition: AJ-01=01, 02

Parameter	Name
db-36	PID2 feedback data monitor
db-55	PID2 output monitor
db-56	PID2 deviation monitor
FA-36	PID2 target value (monitor+setting)
AJ-02	PID2 deviation minus
AJ-03	PID2 unit selection (PID2)
AJ-04	PID2 scale adjustment (0%)
AJ-05	PID2 scale adjustment (100%)
AJ-06	PID2 scale adjustment (decimal point)
AJ-07	PID2 target value Input destination selection
AJ-10	PID2 target value Set value
AJ-12	PID2 feedback data Input destination selection
AJ-13	PID2 proportional gain
AJ-14	PID2 integral gain
AJ-15	PID2 differential gain
AJ-16	PID2 changeable range
AJ-17	PID2 excessive deviation level
AJ-18	PID2 feedback comparison signal OFF level
AJ-19	PID2 feedback comparison signal ON level

## (xiv) PID3

Display condition: AJ-21=01, 02

Parameter	Name
db-38	PID3 feedback data monitor
db-57	PID3 output monitor
db-58	PID3 deviation monitor
FA-38	PID3 target value (monitor+setting)
AJ-22	PID3 deviation minus
AJ-23	PID3 unit selection (PID3)
AJ-24	PID3 scale adjustment (0%)
AJ-25	PID3 scale adjustment (100%)
AJ-26	PID3 scale adjustment (decimal point)
AJ-27	PID3 target value Input destination selection
AJ-30	PID3 target value setting
AJ-32	PID3 feedback data Input destination selection
AJ-33	PID3 proportional gain
AJ-34	PID3 integral gain
AJ-35	PID3 differential gain
AJ-36	PID3 changeable range
AJ-37	PID3 excessive deviation level
AJ-38	PID3 feedback comparison signal OFF level
AJ-39	PID3 feedback comparison signal ON level

## (xx) PID4

Display condition: AJ-41=01, 02

Parameter	Name
db-40	PID4 feedback data monitor
db-59	PID4 output monitor
db-60	PID4 deviation monitor
FA-40	PID4 target value (monitor+setting)
AJ-42	PID4 deviation minus
AJ-43	PID4 unit selection (PID4)
AJ-44	PID4 scale adjustment (0%)
AJ-45	PID4 scale adjustment (100%)
AJ-46	PID4 scale adjustment (decimal point)
AJ-47	PID4 target value Input destination selection
AJ-50	PID4 target value setting
AJ-52	PID4 feedback data Input destination selection
AJ-53	PID4 proportional gain
AJ-54	PID4 integral gain
AJ-55	PID4 differential gain
AJ-56	PID4 changeable range
AJ-57	PID4 excessive deviation level
AJ-58	PID4 feedback comparison signal OFF level
AJ-59	PID4 feedback comparison signal ON level

## (xxi) PID in general

Display condition: AH-01=01, 02 or AJ-01=01, 02 or AJ-21=01, 02 or AJ-41=01, 02

Parameter	Name
AH-75	PID selection of soft-start function
AH-76	PID soft-start target level
AH-78	PID acceleration time for soft-start
AH-80	PID soft-start time
AH-81	PID start abnormal judgment implement selection
AH-82	PID start abnormal judgment level
AH-85	PID sleep condition selection
AH-86	PID sleep start level
AH-87	PID sleep operation time
AH-88	PID selection of boost before sleep
AH-89	PID boost time before sleep
AH-90	PID boost volume before sleep
AH-91	PID minimum operating time before sleep
AH-92	PID minimum retention time of sleep state
AH-93	PID wake condition selection
AH-94	PID wake start level
AH-95	PID wake operation time
AH-96	PID wake start deviation amount

## (xxii) Simulation mode

Display condition: PA-20=01

Parameter	Name
PA-21	Selection of error code for alarm test
PA-22	Output current monitor optional output selection
PA-23	Output current monitor optional setting value
PA-24	P-N voltage monitor optional output selection
PA-25	P-N voltage monitor optional setting value
PA-26	Output voltage monitor optional output selection
PA-27	Output voltage monitor optional setting value
PA-28	Output torque monitor optional output selection
PA-29	Output torque monitor optional setting value
PA-30	Frequency adjustment optional output selection
PA-31	Frequency matching optional setting value

## (xxiii) Trace

Display condition: Ud-01≠00

Parameter	Name
Ud-02	Start of trace
Ud-03	Selection of the number of trace data
Ud-04	Selection of the number of trace signals
Ud-10~17	Selection of trace data 0-17
Ud-20	Trace signal -0 I/O selection
Ud-21	Trace signal -0 Selection of input terminal
Ud-22	Trace signal -0 Selection of output terminal
Ud-23	Trace signal -1 I/O selection
Ud-24	Trace signal -1 Selection of input terminal
Ud-25	Trace signal -1 Selection of output terminal
Ud-26	Trace signal -2 I/O selection
Ud-27	Trace signal -2 Selection of input terminal
Ud-28	Trace signal -2 Selection of output terminal
Ud-29	Trace signal -3 I/O selection
Ud-30	Trace signal -3 Selection of input terminal
Ud-31	Trace signal -3 Selection of output terminal
Ud-32	Trace signal -4 I/O selection
Ud-33	Trace signal -4 Selection of input terminal
Ud-34	Trace signal -4 Selection of output terminal
Ud-35	Trace signal -5 I/O selection
Ud-36	Trace signal -5 Selection of input terminal
Ud-37	Trace signal -5 Selection of output terminal
Ud-38	Trace signal -6 I/O selection
Ud-39	Trace signal -6 Selection of input terminal
Ud-40	Trace signal -6 Selection of output terminal
Ud-41	Trace signal -7 I/O selection
Ud-42	Trace signal -7 Selection of input terminal
Ud-43	Trace signal -7 Selection of output terminal
Ud-50	Selection of trace trigger 1
Ud-51	Selection of operation of trigger 1 when trace data is triggered
Ud-52	Trigger 1 level when trace data is triggered
Ud-53	Selection of operation of trigger 1 when trace signal is triggered
Ud-54	Selection of trace trigger 2
Ud-55	Selection of operation of trigger 2 when trace data is triggered
Ud-56	Trigger 2 level when trace data is triggered
Ud-57	Selection of operation of trigger 2 when trace signal is triggered
Ud-58	Trigger condition selection
Ud-59	Trigger point setting
Ud-60	Sampling time setting

## (xxiv) EzSQ

Display condition: UE-02≠00

Parameter	Name
db-01	Program download monitor
db-02	Program number monitor
db-03~db-07	Program counter (Task1-5)
db-08~db-16	User monitor 0-4
db-18~db-23	Analog output monitor YA0-YA5
UE-01	EzSQ execution interval
UE-10~UE-73	EzSQ user parameter U (00)-U(63)
UF-02~UE-32	EzSQ user parameter UL(00)-U(15)

**■(2) User setting: [UA-10]=02****A**

- Parameters set to the user setting functions [UA-31] to [UA-62], main speed command [FA-01], output frequency monitor [dA-01], and display selection [UA-10] are displayed.

**■(3) Data-comparison display: [UA-10]=03****A**

- Only parameters that have been changed from the factory default settings are displayed.
- All monitor displays [d\*\*\*\*] and [F\*\*\*\*], display selection [UA-10], and the password for display [UA-01] are always shown.

**!**

- The initial value used for comparison is determined by the inverter model and the following settings.
  - Initialized region selection [Ub-02]
  - Duty type selection [Ub-03]
- When base frequency is changed, the standard value of motor constant I0 is changed, which is regarded as change has been made. (The set value is retained.) When calling the initial value of Hitachi's induction motor (IM), by setting [Hb103] selection of the number of poles to another value (e.g., set 4 poles to 2 poles, and then to 4 poles again), you can set data corresponding with the base frequency after change to [Hb116] Motor constant I0.

**■(4) Monitor display: [UA-10]=04****A**

- All monitor displays [d\*\*\*\*] and [F\*\*\*\*] and display selection [UA-10] are shown.

### 9.10.3 Saving Automatically Changed Parameters



- I want to change a parameter value that I changed.



- [UA-31] is the newest data, and [UA-62] is the oldest data.
- Only one value is saved for a parameter.
- If more than 32 parameters are changed, the oldest data of [UA-62] is deleted, and values are shifted by one parameter. Then, new data is saved in [UA-31].



- When selection of user parameter automatic setting [UA-30] is set to 01, parameters whose data has been changed are automatically saved in [UA-31] to [UA-62].
- Also, when you want to retrieve history of parameter changes, set selection of user parameter automatic setting [UA-30] to 01.
- Up to 32 changed parameters can be saved.

#### ■ Parameter

Item	Parameter	Data	Description
User parameter automatic setting selection	[UA-30]	00	Disable
		01	When a parameter is changed, the parameter is automatically set to [UA-31] to [UA-62].
User parameter selection	[UA-31]	no	No assignment
	~ [UA-62]	*****	When this function is enabled, automatically recorded parameters are displayed. (all codes are subjected)



### 9.10.4 Protecting Parameters by Password

**Q**

- I want to protect a parameter value that I changed.
- I do not want anyone to change the setting without permission.

**A**

- By setting a password to the display selection function [UA-10] and soft-lock function [UA-16], you can prevent parameters from being displayed or changed.

**!**

- If you forget the set password, there is no way to unlock the password lock. Also, the password cannot be investigated by our plant or service station, therefore, care must be taken when setting a password.

#### ■ Parameter

Item	Parameter	Data	Description
Password for display	[UA-01]	0000~FFFF	Lock/unlock the display selection function [UA-10].
Soft-lock password	[UA-02]	0000~FFFF	Lock/unlock the soft-lock function [UA-16].
Display selection	[UA-10]	00	All parameters are displayed.
		01	Parameters are displayed by functions. Disabled functions are not displayed with some exceptions.
		02	Display is performed in accordance with the settings configured by the user. Parameters set to [UA-31] to [UA-62] are displayed with some exceptions.
		03	Parameters that have been changed from the factory default settings and some other parameters are displayed.
		04	Monitor parameters and some other parameters are displayed.
Soft-lock selection	[UA-16]	00	When the soft-lock terminal [SFT] is on, changes of data set to [UA-17] other than [UA-16] are locked.
		01	After the setting is performed, changes of data set to [UA-17] other than [UA-16] are locked.
Input terminal selection	[CA-01]~ [CA-11]	036	[SFT]: Used when the soft-lock function is used on terminals.

■ Outline of password function  
(Example of password for limiting display)

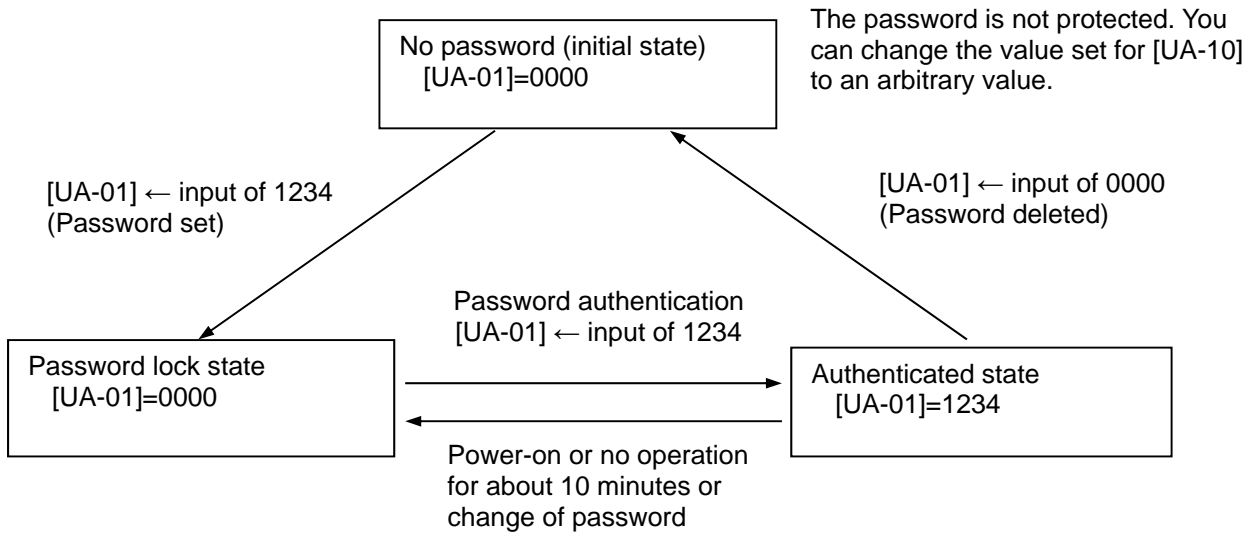

The password is protected. You cannot change the value set for [UA-10]. The LKP icon is displayed in the parameter section.

After password authentication, although the password setting information is not deleted, you can change the value set for [UA-10]. If power is turned on again or 10 minutes pass without any operation, the password is automatically locked again.

■ Outline of password function  
(Example of a soft-lock password)

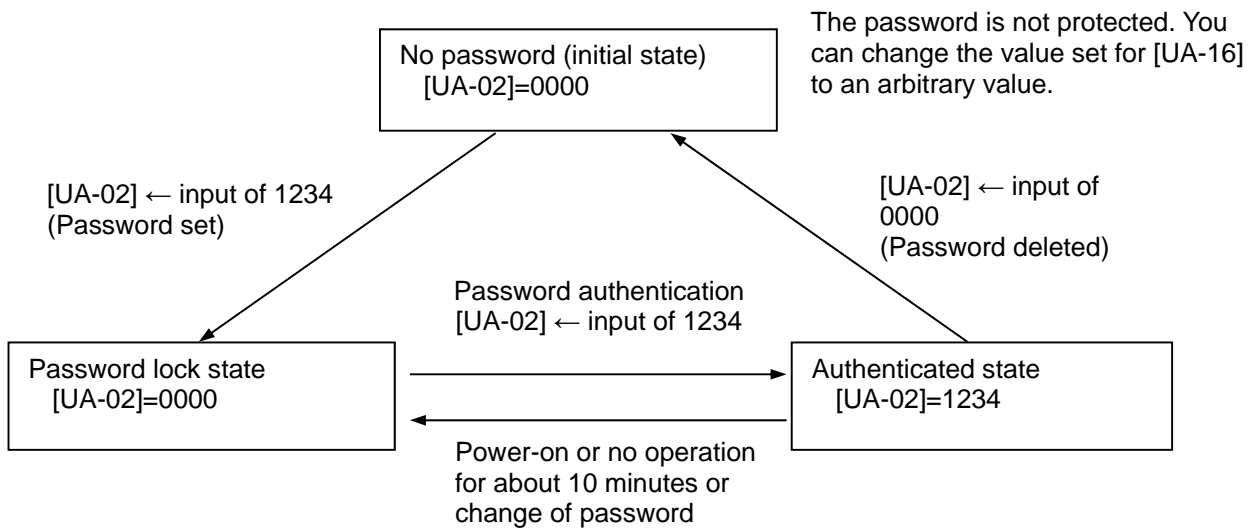

The password is protected. You cannot change the value set for [UA-16]. The LKP icon is displayed in the parameter section.

After password authentication, although the password setting information is not deleted, you can change the value set for [UA-16]. If power is turned on again or 10 minutes pass without any operation, the password is automatically locked again.

## 9.11 Display Fixation Function

### 9.11.1 Fixation of Display Using the DISP Terminal

**Q**

- I don't want anyone to operate the device on the operator keypad without permission.

**A**

- When the [DISP] function of the input terminal function is on, display of the operator keypad VOP is fixed on the monitor screen (the home screen selected in VOP).
- When the [DISP] function of the input terminal function is on, keys other than the RUN key and STOP/RESET keys are disabled.
- To disable the RUN key, set [AA111] to a value other than 02.
- The following shows operations when the [DISP] terminal is on.
  - When STOP key selection [AA-13] is 01, even if [AA111] is other than 02, you can stop the inverter or reset inverter trip by using the STOP/RESET key.
  - When STOP key selection [AA-13] is 02, even if [AA111] is other than 02, you can reset inverter trip by using the STOP/RESET key.
  - When STOP key selection [AA-13] is 00, if [AA111] is other than 02, the STOP/RESET key is also disabled, thus disabling all keys.

#### ■ Parameter

Item	Parameter	Data	Description
Selecting the input terminal	[CA-01]~ [CA-11]	102	[DISP]: Used when the screen fixation function is used on terminals.
Operation command selection	[AA111]	00	[FW]/[RV] terminals
		01	3 wire
		02	RUN key on the operator keypad
		03	RS485 setting
		04	Option 1
		05	Option 2
		06	Option 3
STOP key selection	[AA-13]	00	Disable
		01	Enable
		02	Enable only reset

## 9.12 Error Operation on the Operator Keypad

### 9.12.1 Selection of Operation at Disconnection of Operator Keypad

**Q**

- I want to trip the inverter when connection with the operator keypad is shut off.
- I want to decelerate and stop the inverter when connection with the operator keypad is shut off.

**A**

- You can configure operation when the operator keypad is disconnected. When about 5 seconds have passed after communication with the operator keypad is disconnected, it is determined that disconnection occurred.
- For operation at disconnection, see the parameter table shown below.

#### Parameter

Item	Parameter	Data	Description
Selection of operation at disconnection of operator keypad	[UA-20]	00	When disconnection occurs, the inverter trips due to [E040] Operator keypad communication error.
		01	When disconnection occurs, the inverter trips with [E040] Operator keypad communication error after deceleration stop.
		02	Ignores detection of disconnection.
		03	Performs the free-run stop when disconnection occurs. No error occurs.
		04	Performs the deceleration stop when disconnection occurs. No error occurs.

### 9.12.2 Display of Battery Level Warning

**Q**

- I want to know if I should replace the battery of the operator keypad VOP when it runs out.
- I want to trip the inverter due to error when the battery of the operator keypad runs out.

**A**

- The operator keypad VOP is monitored on a regular basis, and when it is determined the time setting of operator keypad VOP returns to the initial state, it is determined to be error.
- When [UA-19] is set to 01 and it is determined that abnormality occurs, the output terminal function 080 [LBK] is turned on. When time is configured on VOP, [LBK] is turned off.
- When [UA-19] is set to 02, when it is determined that abnormality occurs, an error is generated, and the inverter trips due to [E042] RTC error. The output terminal function 080 [LBK] is turned on at the same time the error occurs. When time on VOP is configured, [LBK] is turned off.

**!**

- You can cancel trip of [E042] RTC error by performing the reset operation, however, if time is not configured, the error occurs again. In this case, the output terminal function 080 [LBK] is on.
- If [UA-19] is set to a value other than 00, insert the battery in the operator keypad VOP, and set [UA-19] after configuring time.

#### ■ Parameter

Item	Parameter	Data	Description
Battery level warning selection	[UA-19]	00	Disable
		01	The output terminal function 080 [LBK] is turned on as a warning.
		02	Generates the [E042] RTC error and the inverter trips. Turns on the output terminal function 080 [LBK].

## 9.13 Preventing Read and Write of Unnecessary Data

### 9.13.1 Disabling Data R/W

**Q**

- I don't want anyone to read data on the operator keypad VOP.
- I don't want anyone to write data on the operator keypad VOP.

**A**

- By setting [UA-18] Data R/W selection to 01, Read/Write access from VOP is disabled, and read and write of unnecessary data can be prevented.
- After the parameter is confirmed, if it is set to 01 after data is read for backup, unnecessary read and write can be prevented.

#### ■ Parameter

Item	Parameter	Data	Description
Data R/W selection	[UA-18]	00	R/W enabled. Read and write are possible.
		01	R/W disabled. Read and write are prohibited.

(Memo)

## 10

# Chapter 10 Test Run

## Contents





10.1 What This Chapter Explains .....	10-1
10.2 Let's Check the Procedures Before Test Runs ! .....	10-2
10.3 Settings and Commands Required for Running the Inverter.....	10-3
10.4 Let's Configure Settings for Test Runs! .....	10-4
10.4.1 To perform test runs via operator keypad VOP .....	10-4
10.4.2 Running by attaching a variable resistor tab to the terminal block [FW] input, H, Ai1, and L .....	10-6
10.4.3 Supplement .....	10-7
10.5 Checking in the simulation mode.....	10-8

## 10.1 What This Chapter Explains

This chapter provides an operational flow to do a test run.

For method for using the operator keypad VOP, see “Chapter 10.4.1 Operation Using the Operator Keypad VOP” and “Chapter 9 Operating Instructions”. Furthermore, to do a test run not via the operator keypad VOP, configure the setting by referring to “Chapter 11 Examples of Settings by Operation Command Destination”.

Before conducting a test run, make sure to carefully read “Chapter 1 Safety Instructions/Risks” for safety work.

Symbol	Meanings
	General and troubleshooting questions
	Key points for a solution
	Notes
	Confirmation of procedures



## 10.2 Let's Check the Procedures Before Test Runs !



- Want to check the procedure for test runs.
- Want to check the operation performance between this unit and the host device even though a load and motor have not been connected yet.
- Want to confirm how the system behaves in an error condition, via making error conditions.



- To perform a test run, follow the procedures shown below.
- Carefully read and understand “Chapter 1 Safety Instructions” and the relevant instructions in the following chart before starting works.

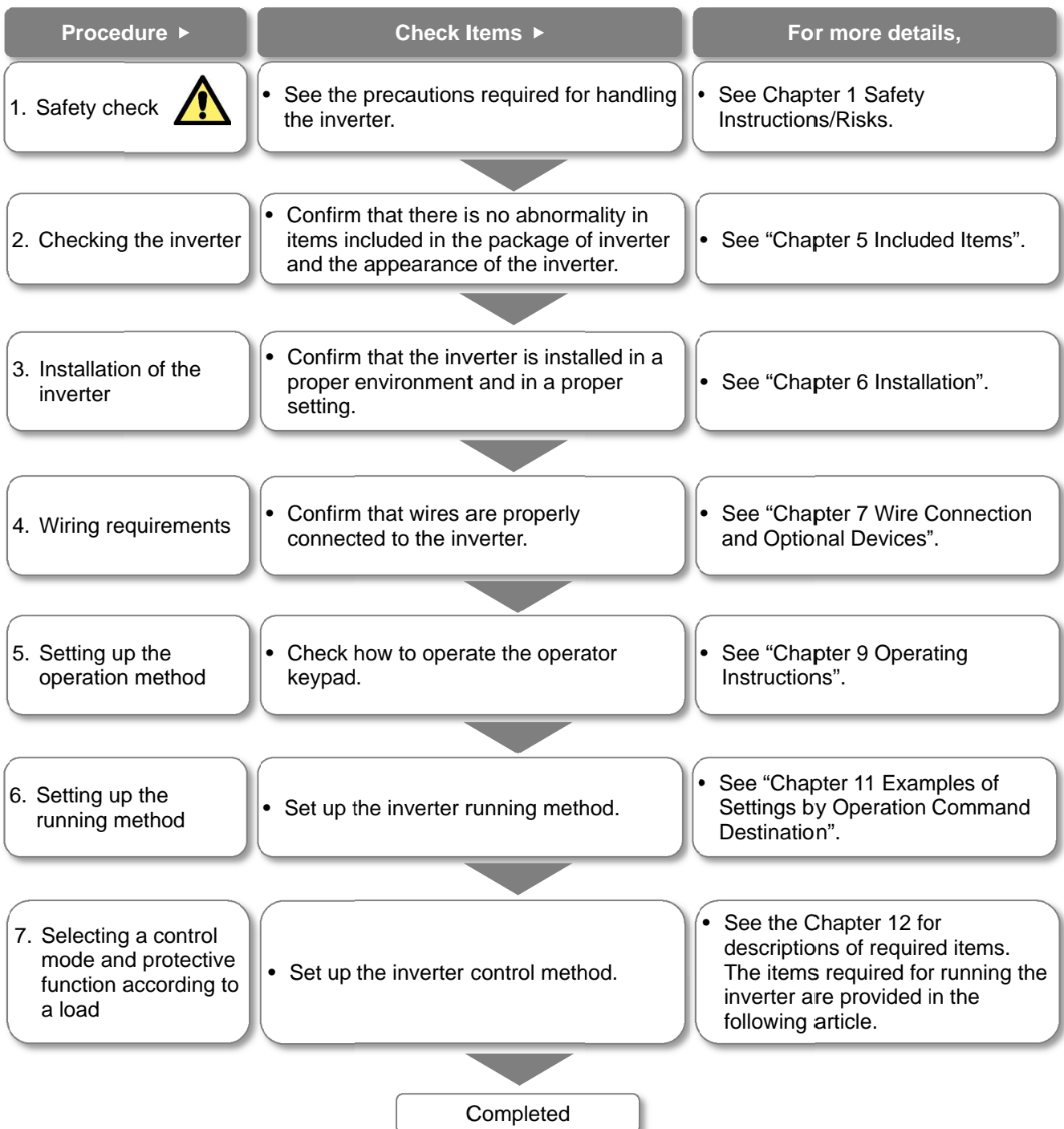

## 10.3 Settings and Commands

### Required for Running the Inverter



- Want to turn the motor.



- To turn the motor, configure the following settings:

#### 1

Basic setting for motor

- Set the following parameters in accordance with the plate of motor. Set the data indicating the basic characteristics of motor.

Item	Parameter	
	IM	SM(PMM)
Motor capacity selection	[Hb102]	[Hd102]
Selection of number of motor poles	[Hb103]	[Hd103]
Base frequency (frequency)	[Hb104]	[Hd104]
Maximum frequency (frequency)	[Hb105]	[Hd105]
Rated voltage of motor	[Hb106]	[Hd106]
Rated current of motor	[Hb108]	[Hd108]

\*) See "12.3 Basic Settings for Motor" for details.

#### 2

Setting for protection of motor

- The motor may be burned if a large current keeps on flowing in the motor; the setting therefore must be performed appropriately.

Item	Parameter
First electronic thermal level	[bC110]
First electronic thermal characteristics selection	[bC111]

\*) See "12.7 Temperature Protection of Motor" for details.

#### 3

Setting for activating the motor

- The voltage output of the inverter requires not only an operation command but also a frequency command. In the initial state, a main speed command is used as a frequency command.

Item	Parameter
First main speed command selection	[AA101]
First operation command selection	[AA111]
Main speed command	[FA-01]

\*) For details, see "12.4 Select a Frequency Command", "12.5 Selecting a Operation Command" and "Chapter 11 Examples of Settings by Operation Command Destination".



- This article explains the settings for operation. Carefully read Safety Instructions before handling the inverter.

#### 4

Settings for motor control

- Set the motor control method.
- For changing to the mode of driving an SM (PMM), you need to change the control method.

Item	Parameter
First control mode	[AA121]

\*) For details, see "12.9 Select motor control method in accordance with motor and load".

- When driving an SM (PMM) or using other motors than Hitachi's standard motors, or setting long wiring length, you need to set up the following motor constants:

- For induction motor IM

Item	Parameter
First IM motor constant R1	[Hb110]
First IM motor constant R2	[Hb112]
First motor constant L	[Hb114]
First IM motor constant I0	[Hb116]
First IM motor constant J	[Hb118]

- For synchronous motor (permanent magnetic motor) (SM (PMM))

Item	Parameter
First SM (PMM) motor's constant R1	[Hd110]
First SM (PMM) motor's constant Ld	[Hd112]
First SM (PMM) motor's constant Lq	[Hd114]
First SM (PMM) motor's constant Ke	[Hd116]
First SM (PMM) motor's constant J	[Hd118]

## 10.4 Let's Configure Settings for Test Runs!

### 10.4.1 To perform test runs via operator keypad VOP



- Want to perform a test run using operator keypad VOP.



- From the initial screen displayed at power-on, move to "H03" with the LEFT/RIGHT (◀▶) keys.
- For procedure of changing parameters, see "9.3 Let's Set Parameters".



- To perform a test run only via operator keypad VOP, set the following parameters from the initial value, or check the following parameters.

- ① Frequency command destination selection [AA101]
- ② Main speed command [FA-01]
- ③ Operation command destination selection [AA111]
- ④ Setting the electronic thermal level of motor [bC110]

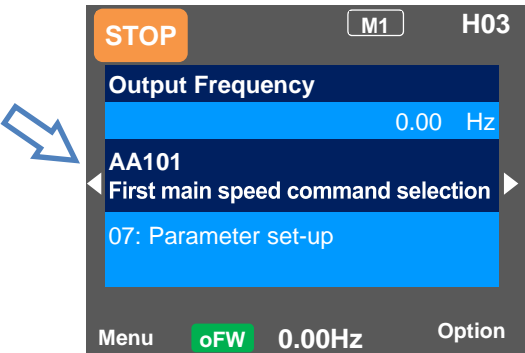
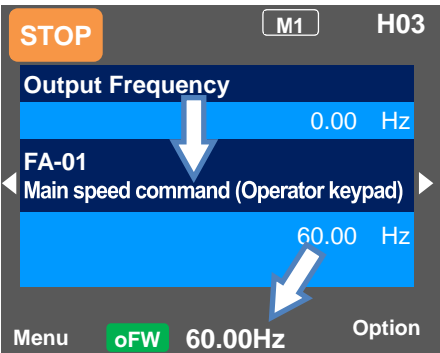
Display description	Setting item
<p>①</p>  <p>Menu <b>oFW</b> 0.00Hz Option</p>	<p>① Frequency command destination selection [AA101] Set the frequency command destination to "07: Parameter set-up".</p>
<p>②</p>  <p>Menu <b>oFW</b> 60.00Hz Option</p>	<p>② Main speed command [FA-01] When the frequency command destination is set to "07: Parameter set-up", "Main speed command (Operator keypad)" will be shown. If a frequency command is set in this state, the value will be shown at the bottom command monitor area.</p>

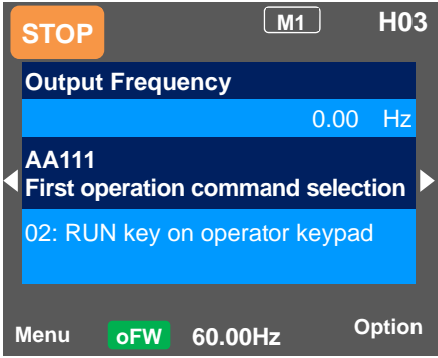
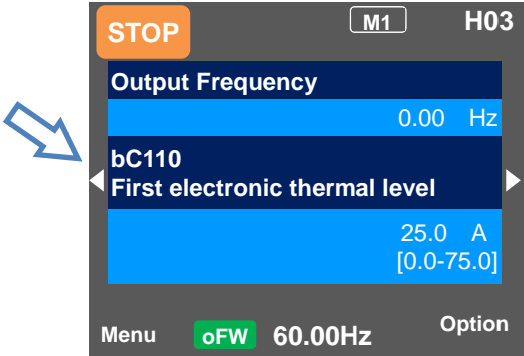
Setting item	Note
<p>③</p> 	<p>③ Operation command destination selection [AA111]  When the operation command destination is set to "02: RUN key on operator keypad", "oFW" will be shown on operator keypad at the bottom in the area for displaying function of RUN key.  ※ When the destination is set to reverse, "oRV" will be shown.</p>
<p>④</p> 	<p>④ Setting the electronic thermal level of motor [bc110]  Set the level so that it does not exceed the rated current of motor.  ⚠ Note that the motor may be burned if the electronic thermal level is not appropriately set.  ※ The electronic thermal for protecting the inverter works automatically.</p>

### 10.4.2 Running by attaching a variable resistor tab to the terminal block [FW] input, H, Ai1, and L



- Want to perform a test run, using a variable resistor.
- Want to run with 10V voltage input.



- From the initial screen displayed at power-on, move to "H03" with the LEFT/RIGHT arrow (◀▶) keys.
- For procedure of changing parameters, see "9.3 Let's Set Parameters".

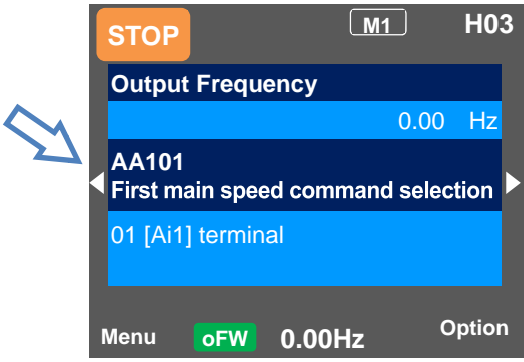
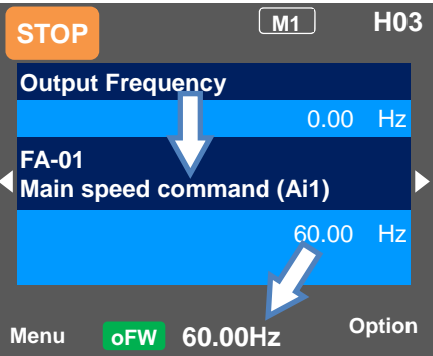

- To perform a test run using analogue input Ai1, set the following parameters from the initial value, or check the following parameters.
  - ① Frequency command destination selection [AA101]
  - ② Main speed command [FA-01]
  - ③ Operation command destination selection [AA111]
  - ④ Setting the electronic thermal level of motor [bC110]

Display description	Setting item
① 	① Frequency command destination selection [AA101] Set the frequency command destination to "01: Ai1 input".
② 	② Checking the main speed command [FA-01] When the operation command destination is set to "01: Ai1 input", "Main speed command (Ai1)" will be shown. If a frequency command is set in this state, the value will be shown at the bottom command monitor area.



Do

- To connect a cable between Ai1 and L, or between Ai2 and L, make sure to check that a desired input (voltage or current) is provided to the corresponding positions of DIP switch SW1 and SW2.



Failure



Prohibited

- A damage may be caused by inputting a wrong voltage or current for reasons such as wrong selection of switches, input beyond the specification range (P24 terminal of 24V is used instead of H terminal of 10V), and wrong wiring (voltage/current being input reversely because the wire is connected in the wrong way; a cable between H and L is short-circuited at 0 Ω during wiring of a tab; and so on).

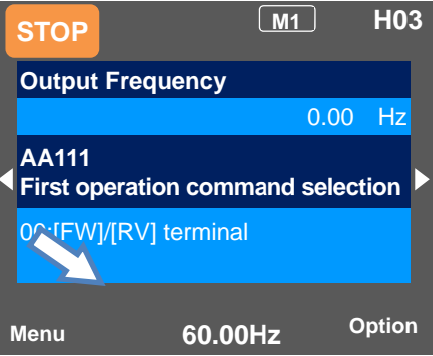
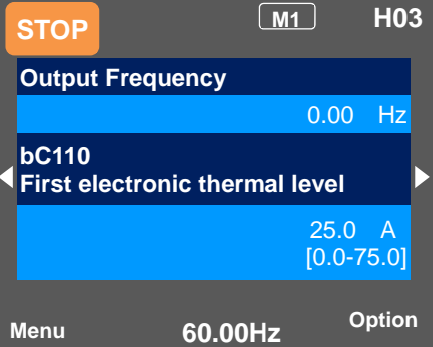
Setting item	Note
<p>③</p> 	<p>③ Operation command destination selection [AA111] When the operation command destination is set to "00:[FW]/[RV] terminal", the display will disappear from the area for displaying function of RUN key on operator keypad at the bottom.</p> <p>※ Normal/reverse rotation can be set at [FW]/[RV] terminal.</p>
<p>④</p> 	<p>④ Setting the electronic thermal level of motor [bc110] Set the level so that it does not exceed the rated current of motor.</p> <p>⚠ Note that the motor may be burned if the electronic thermal level is not appropriately set.</p> <p>※ The electronic thermal for protecting the inverter works automatically.</p>

### 10.4.3 Supplement



- Check the setting of the motor capacity, the number of motor poles, frequency, voltage, and current in order to conduct motor control.
- IM: Induction motor
- In the initial state, the motor is in the V/f control mode, in which voltage is output proportional to the frequency for induction motor control. For control modes, see "12.9 Selecting the Motor Control Mode according to Motor and Load".

General motor items	Code	Setting range (unit)
Capacity	[Hb102]	0.01~160.00 (kW)
Number of motor poles	[Hb103]	2 to 48 (poles)
Frequency	[Hb104]	10.00~590.00 (Hz)
	[Hb105]	10.00~590.00 (Hz)
Voltage	[Hb106]	1~1000 (V)
Current	[Hb108]	0.01~10000.00 (A)

- SM (PMM): Synchronous (permanent magnet) motor

General motor items	Code	Setting range (unit)
Capacity	[Hd102]	0.01~160.00 (kW)
Number of motor poles	[Hd103]	2 to 48 (poles)
Frequency	[Hd104]	10.00~590.00 (Hz)
	[Hd105]	10.00~590.00 (Hz)
Voltage	[Hd106]	1~1000 (V)
Current	[Hd108]	0.01~10000.00 (A)

- See "12.3 Basic Settings for Motor" for details.

## 10.5 Checking in the simulation mode



- Want to check a terminal without letting the inverter outputs.
- Want to perform a simulative operation check by giving an operation command without outputting.



- If the simulation mode [PA-20] is set to 01 and the power is turned on again, the inverter enters the simulation mode and does not output to the motor.
- To cancel the simulation mode, set [PA-20] to 00 and then turn on the power again.
- Because the inverter behaves just like a normal operation except that it cannot output to the motor, you can check terminals and communication operations.
- It will be possible to change the internal data on a real-time basis by assigning a parameter or analog input to the internal data.
- Operation checks can be performed in the condition that the control power supply is input or 24-V power supply is used.
- If the error code selection [PA-21] is set during the simulation mode, a trip is issued as soon as the setting is made. To cancel a trip, reset the inverter (turn ON the [RS] terminal or press RESET key) as usual. When the inverter is reset, [PA-21] will be automatically set to 00.



- The motor cannot be driven in the simulation mode.
- To check the actual motor behavior, set the simulation mode [PA-20] to “00: Disable” and then turn on the power again.
- To activate the simulation mode, activate it in the condition that 24-V power supply is input for 24-V power supply; that control power supply is input for control power supply terminals (R0, T0) inputs; and that R, S, and T terminals are input for main power supply inputs R, S, and T. Then turn off the power to end the simulation mode.
- Because the simulation mode is for simulating terminals' behaviors, the function activated by a motor control operation does not work.
- In the simulation mode, if an error not listed in the selection of error code for alarm test [PA-21] is entered, the error will not be generated.
- In the simulation mode, if a serious fault error is entered to the selection of error code for alarm test [PA-21], the power needs to be turned on again. (Serious fault errors: E010, E011, E014, E019, E020)



Entering the simulation mode

1

Set the simulation mode [PA-20] to 01.

2

Turn off the power, and then turn it on again.

3

The simulation mode becomes active.



Canceling the simulation mode

1

Set the simulation mode [PA-20] to 00.

2

Turn off the power, and then turn it on again.

3

The simulation mode is canceled.

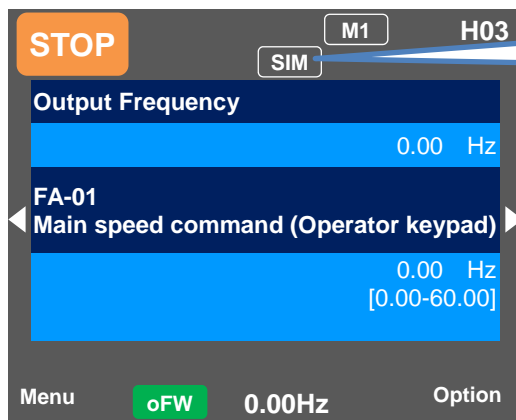

Indicated during the simulation mode.

(Example: usage 1)

Checking the behavior while the alarm [AL] is on.

- The operation was started.
- P-N voltage monitor optional selection [PA-24] was set to 01, and P-N voltage monitor optional setting value [PA-25] was set to the maximum value.

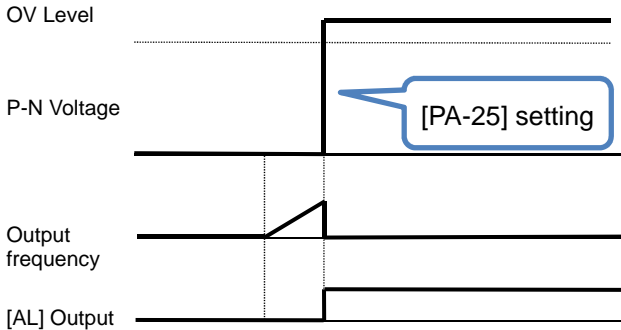

- An overvoltage error [E007] occurred and [AL] was ON.

(Example: usage 2)

Checking the signal output of overload prewarning level [OL].

- The overload prewarning level [CE106] was set, and the operation was started.
- Output current monitor optional output selection [PA-22] was set to 02, and [Ai1] was increased and decreased.

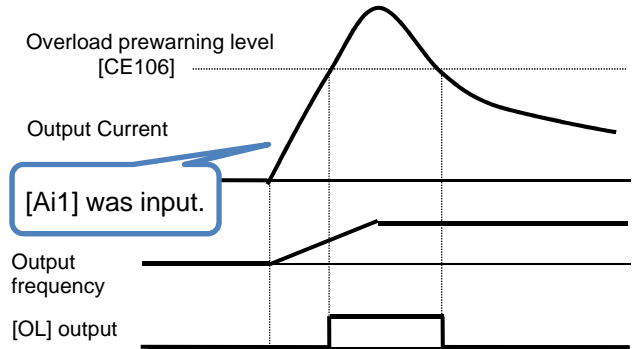

- [OL] was turned ON because the output current exceeded the overload prewarning level [CE106].

■ Parameter

Item	Parameter	Data	Description
Simulation mode	[PA-20]	00	Disable
		01	Enable
Selection of error code for alarm test	[PA-21]	000~255	Issues a set error. Errors not listed in the selection do not occur.
Output current monitor optional output selection P-N voltage monitor optional output selection Output voltage monitor optional output selection Output torque monitor optional output selection Frequency adjustment frequency optional output selection	[PA-22] [PA-24] [PA-26] [PA-28] [PA-30]	00	Disable
		01	Enable (Parameter setting)
		02	Enable (Setting by [Ai1])
		03	Enable (Setting by [Ai2])
		04	Enable (Setting by [Ai3])
		05	Enable (Setting by [Ai4])
		06	Enable (Setting by [Ai5])
		07	Enable (Setting by [Ai6])
Output current monitor optional setting value	[PA-23]	0.0 to 3.0 × Inverter rated current (A)	Treats the set values as internal output values.
P-N voltage monitor optional setting value	[PA-25]	200V class: 0.0 to 450.0 (Vdc) 400V class: 0.0 to 900.0 (Vdc)	Treats the set values as internal output values.
Output voltage monitor optional setting value	[PA-27]	200V class: 0.0-300.0(V) 400V class: 0.0-600.0(V)	Treats the set values as internal output values.
Output torque monitor optional setting value	[PA-29]	-500.0~500.0 (%)	Treats the set values as internal output values.
Frequency matching frequency optional setting value	[PA-31]	0.00~590.00 (Hz)	Treats the set values as internal output values.





# 11

## Chapter 11 Examples of Settings by Operation Command Destination

### Contents

- 11.1 What This Chapter Explains ..... 11-1
- 11.2 Frequency and operation commands ..... 11-1
  - 11.2.1 Setting the operator keypad..... 11-2
  - 11.2.2 Operating on operator keypad ..... 11-2
  - 11.2.3 Commanding by the multi-speed terminal ..... 11-3
  - 11.2.4 Operating using FW/RV terminal ..... 11-3**
  - 11.2.5 Commanding by using a frequency setter ..... 11-4
  - 11.2.6 Operation on 3 wire terminals ..... 11-4
  - 11.2.7 Adjusting analog inputs (Ai1/Ai2) ..... 11-5
  - 11.2.8 Adjusting analog outputs (Ao1/Ao2/FM)..... 11-5
  - 11.2.9 Adjusting analog input (Ai3) ..... 11-6
  - 11.2.10 Prevention of malfunction of input terminals..... 11-6
  - 11.2.11 Stabilization of output terminals ..... 11-6

### 11.1 What This Chapter Explains

This chapter provides examples of settings by connection at a frequency command destination and operation command destination. In respective settings, an operation command and frequency command are to be set separately; hence it is possible to set according to working environments by combining each command. Make sure to carefully read “Chapter 1 Safety Instructions/Risks” for safety work.

### 11.2 Frequency and operation commands



- In this chapter, frequency commands and operation commands are explained separately. Both frequency commands and operation commands can be combined with other examples.



- The inverter does not output until both a frequency command (e.g. 60Hz) and an operation command (forward rotation command) are entered.

Symbol	Meanings
	General and troubleshooting questions
	Key points for a solution
	Notes
	Confirmation of procedures

■ Frequency command 1

11.2.1 Setting the operator keypad

- On the parameter setting screen, select [AA101] = 07 frequency command.
- Frequency command can be changed using (1) parameter [FA-01] (if the operator keypad is used); or (2) parameter setting [Ab110].

(Example) For [FA-01]

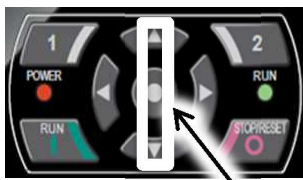
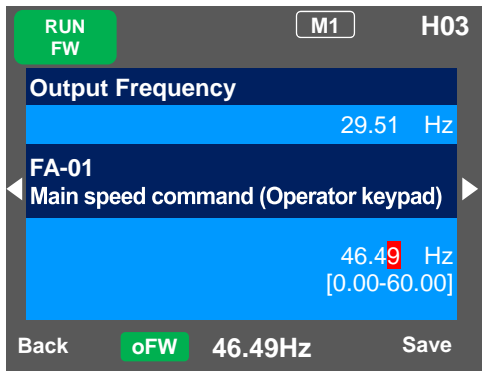

■ Frequency command

- Frequency command can be changed by using UP/DOWN keys to set the main speed command [FA-01] to a desired setting.

■ Parameter

Parameter	Setting function	Set value
[AA101]	Frequency setting by setting on the operator keypad	07
[FA-01]*)	Main speed command	0.00Hz
[Ab110]*)	0th speed of the 1st multi-step speed	0.00Hz

\*) If [AA101] is set to 07, a change made to either [FA-01] or [Ab110] parameter will be reflected to the other parameter. If [FA-01] cannot be changed or a change is not reflected, it means that the command destination hasn't been the operator keypad due to terminal functions or setting of [AA101]. You need to set the frequency value other than 0.00.

■ Operation command 1

11.2.2 Operating on operator keypad

- On the parameter setting screen, select 02 for [AA111].



RUN key (to operate)

STOP key (to stop)



■ Operation and stop commands

You can operate or stop by pressing RUN key or STOP key on the operator keypad.

■ Parameter

Parameter	Setting function	Set value
[AA111]	Operates with RUN key on the operator keypad.	02

■ Frequency command 2

**11.2.3** Commanding by the multi-speed terminal

- Where a multi-speed command hasn't been entered, the command complies with [AA101].
- Where zero speed is used, select 07 for [AA101].

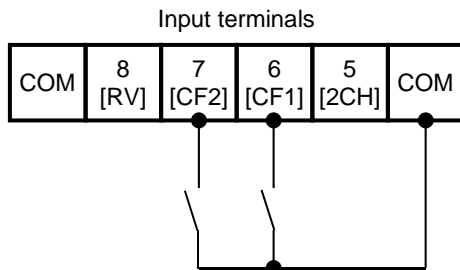

■ Frequency command

- Switch the frequency command by ON/OFF inputs of the multi-speed terminals [CF1] and [CF2].

■ Parameter

Parameter	Setting function	Set value
[AA101]	Frequency setting by setting on the operator keypad	07
[FA-01]*1)	Main speed command	0.00Hz
[Ab110]*1)	0th speed of the 1st multi-step speed ([CF1]OFF/[CF2]OFF)	0.00Hz
[Ab-11]*2)	1st speed of the multi-step speed ([CF1]ON/[CF2]OFF)	0.00Hz
[Ab-12] *2)	2nd speed of the multi-step speed ([CF1]OFF/[CF2]ON)	0.00Hz
[Ab-13] *2)	3rd speed of the multi-step speed ([CF1]ON/[CF2]ON)	0.00Hz
[CA-06]	Terminal No. 6 is for [CF1].	001
[CA-07]	Terminal No. 7 is for [CF2].	002

\*1) If [AA101] is set to 07, a change made to either [FA-01] or [Ab110] parameter will be automatically reflected to the other parameter. If [FA-01] cannot be changed or a change is not reflected, it means that the command destination hasn't been the operator keypad due to terminal functions or setting of [AA101].

\*2) Set the frequency command used at the multi-step speed command.

■ Operation command 2

**11.2.4** Operating using FW/RV terminal

- Select 00 [FW]/[RV] terminal for [AA111] on the parameter setting screen.

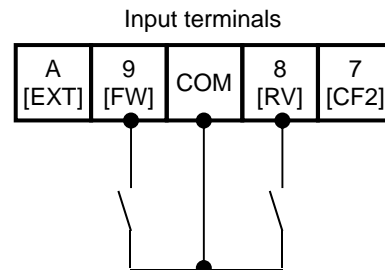

■ Operation and stop commands

You can operate or stop by ON/OFF inputs of either the [FW] terminal or [RV] terminal.

■ Parameter

Parameter	Setting function	Set value
[AA111]	Operation by [FW]/[RV] terminal	00
[CA-09]	Terminal No. 9 is for [FW].	001
[CA-08]	Terminal No. 8 is for [RV].	002

■ Frequency command 3

**11.2.5** Commanding by using a frequency setter

- Select 01 for [AA101] on the parameter setting screen.
- ※ The switch for Ai1 on the control circuit board needs to be voltage.

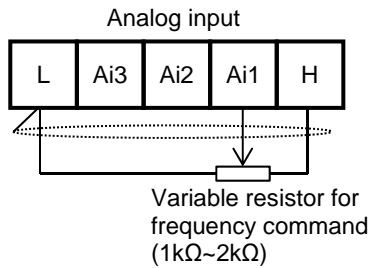

■ Frequency command

- Switch the frequency command by adjusting the tab position of frequency setter.

■ Parameter

Parameter	Setting function	Set value
[AA101]	Gives a frequency command with Ai1 terminal input.	01

■ Operation command 3

**11.2.6** Operation on 3 wire terminals

- On the parameter setting screen, select 01 for [AA111]. In this paragraph, the 3-wire function is assigned to the input terminal function.

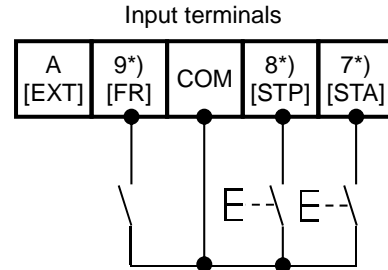

\*) Terminal No. 7 [CA-07]=016, No. 8 [CA-08]=017, No. 9 [CA-09]=018



■ Operation and stop commands

- To start operation, turn ON the [STA] terminal; to stop, turn ON the [STP] terminal. Select the rotation direction using the [FR] terminal.

■ Parameter

Parameter	Setting function	Set value
[AA111]	Gives a frequency command using the 3 wire function.	01
[CA-09]	Terminal No. 9 is for [FR].	018
[CA-08]	Terminal No. 8 is for [STP].	017
[CA-07]	Terminal No. 7 is for [STA].	016

Adjustment of I/O terminals - Example 1

11.2.7 Adjusting analog inputs (Ai1/Ai2)

(Example) Adjusting the operation (example for Ai1)

- You can limit the operation range of command frequency by setting the ratio to the input. (where a frequency is given via terminal input)

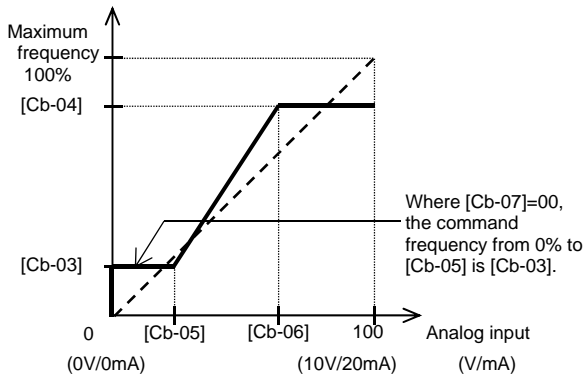

Parameter

Parameter		Setting function
Ai1	Ai2	
[Cb-03]	[Cb-13]	Sets a frequency command ratio to a start ratio for analog input.
[Cb-04]	[Cb-14]	Sets a frequency command ratio to an end ratio for analog input.
[Cb-05]	[Cb-15]	Sets a start ratio for analog input for 0 to 10 V/0 to 20 mA.
[Cb-06]	[Cb-16]	Sets the end ratio for analog input for 0 to 10 V/0 to 20 mA.

- Ai2 can be adjusted by substituting Ai1 parameter of the example with Ai2 parameter.

(Example) Making fine adjustment (example for Ai1)

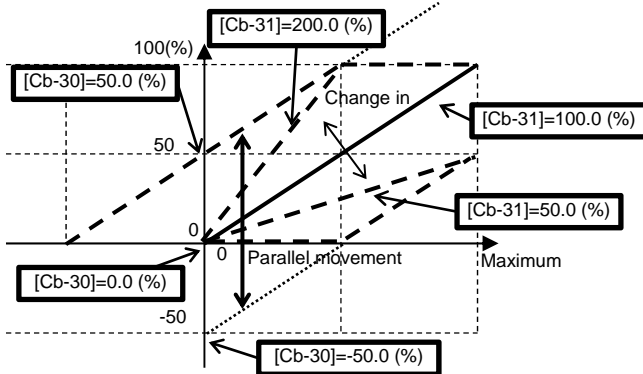

Parameter

Parameter		Setting function
Ai1	Ai2	
[Cb-30]	[Cb-32]	Adjusts the zero point of reference line to voltage input 10 V / current input 20 mA and the maximum frequency.
[Cb-31]	[Cb-33]	Adjusts the inclination of reference line of voltage input 10 V / current input 20 mA.

\*) Voltage and current inputs can be switched using the switch on the board.

Adjustment of I/O terminals - Example 2

11.2.8 Adjusting analog outputs

(Ao1/Ao2/FM)

(Example) Adjusting the operation (example for Ao1)

- Firstly, set a value equivalent to 0% output.

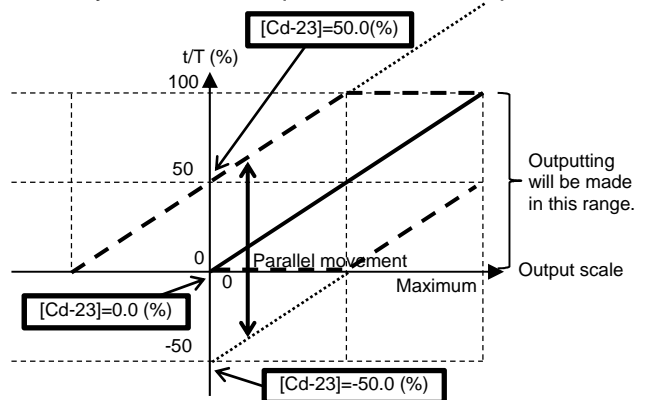

- Secondly, adjust a value equivalent to 100% output.

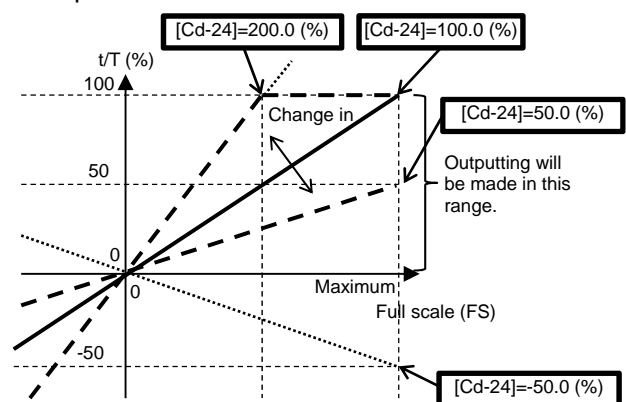

Parameter

Parameter			Setting function
Ao1	Ao2	FM	
[Cd-23]	[Cd-33]	-	Adjusts the zero point of reference line to voltage output 10 V / current output 20 mA and data at 100%.
[Cd-24]	[Cd-34]	-	Adjusts the inclination of voltage output 10 V / current output 20 mA and data at 100%.
-	-	[Cd-13]	Adjusts the zero point of reference line to output 100% duty ratio and data at 100%.
-	-	[Cd-14]	Adjusts the inclination of output 100% duty ratio and data at 100%.

■ Adjustment of I/O terminals - Example 3

**11.2.9** Adjusting analog input (Ai3)

(Example) Adjusting the operation (example for Ai3)

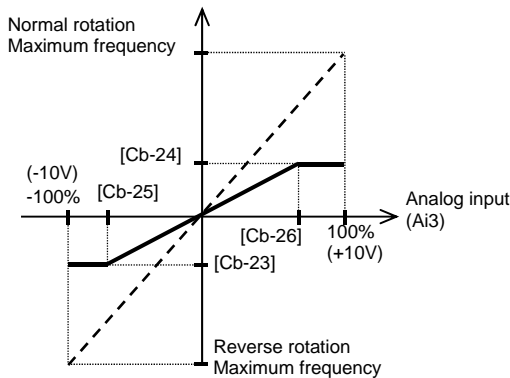

■ Parameter

Parameter	Setting function
Ai3	
[Cb-23]	Sets a frequency command ratio to a start ratio for analog input.
[Cb-24]	Sets a frequency command ratio to an end ratio for analog input.
[Cb-25]	Sets a start ratio for analog input for -10 to 10V.
[Cb-26]	Sets an end ratio for analog input for -10V to 10V.

(Example) Making fine adjustment

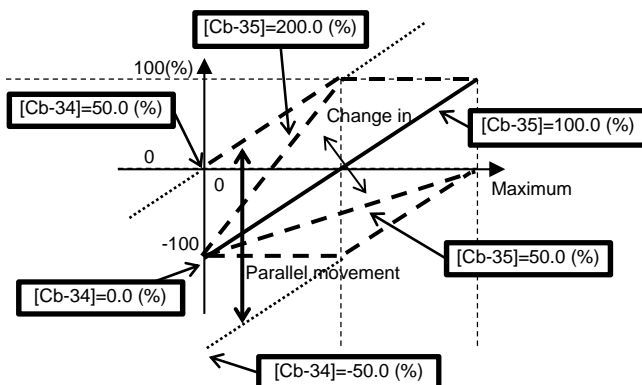

■ Parameter

Parameter	Setting function
Ai3	
[Cb-34]	Adjusts -10V of the reference line to -10V/10V and frequency.
[Cb-35]	Adjusts the inclination of reference line.

■ Adjustment of I/O terminals - Example 4

**11.2.10** Prevention of malfunction of input terminals

- Malfunctions due to noises or other factors can be prevented by setting responses of input terminals.

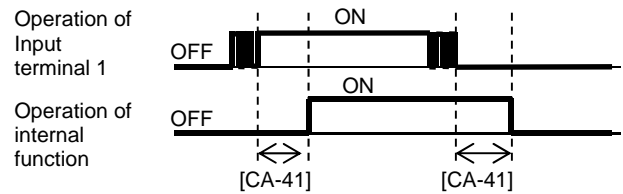

■ Parameter

Input terminals	Response time	Input terminals	Response time
1	[CA-41]	7	[CA-47]
2	[CA-42]	8	[CA-48]
3	[CA-43]	9	[CA-49]
4	[CA-44]	A	[CA-50]
5	[CA-45]	B	[CA-51]
6	[CA-46]		

■ Adjustment of I/O terminals - Example 5

**11.2.11** Stabilization of output terminals

- Excess sensitive reactions of internal functions can be stabilized by setting delays of output terminals.

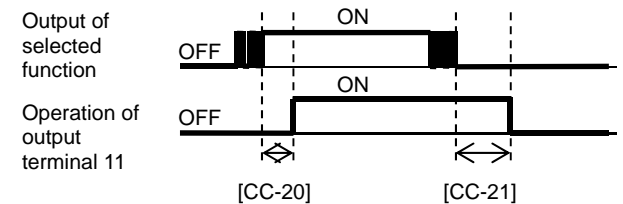

■ Parameter

Output terminal	On-delay time	Off-delay time
11	[CC-20]	[CC-21]
12	[CC-22]	[CC-23]
13	[CC-24]	[CC-25]
14	[CC-26]	[CC-27]
15	[CC-28]	[CC-29]
16A-16C	[CC-30]	[CC-31]
AL1-AL0/ AL2-AL0	[CC-32]	[CC-33]

## 12

# Chapter 12 Inverter Functions

## 12.1 What This Chapter Explains

This chapter describes various functions of the inverter. Select a function that you want to use and configure it.

Make sure to carefully read “Chapter 1 Safety Instructions/Risks” for safety work.







Caution

- Wrong parameter setting could cause unexpected operation and result in a dangerous situation.



Do

- Check and carefully read “Chapter 1 Safety Instructions/Risks” again before setting parameters. Carefully read a note for each parameter.

Symbol	Meanings
	General and troubleshooting questions
	Key points for a solution
	Notes
	Confirmation of procedures



- Search a function to use.



- Show the content of this chapter.

Chapter	Item	Page
12.2	Basic setting of inverter	12-2-1
12.3	Basic setting of motor	12-3-1
12.4	Select a frequency command.	12-4-1
12.5	Select an operation command.	12-5-1
12.6	Limit frequency and operation commands.	12-6-1
12.7	Thermal protection of motor	12-7-1
12.8	Use a function to accelerate or decelerate the motor.	12-8-1
12.9	Select a motor control method suitable for motor and load.	12-9-1
12.10	Process control suitable for system	12-10-1
12.11	Torque control suitable for load	12-11-1
12.12	Adjust motor sound, noise, and inverter heat.	12-12-1
12.13	Use the tripless function.	12-13-1
12.14	Change the way of start.	12-14-1

Chapter	Item	Page
12.15	Change the way of stop.	12-15-1
12.16	Use a system protection function.	12-16-1
12.17	Switch the operation mode for operation.	12-17-1
12.18	Control the cooling fan of the inverter.	12-18-1
12.19	Output a warning signal to the terminal.	12-19-1
12.20	Output operation status to the terminal.	12-20-1
12.21	Compare output frequency and output it to the terminal.	12-21-1
12.22	Detect disconnection or out-of-range of analogue input.	12-22-1
12.23	Combine output signals and output them to the terminal.	12-23-1
12.24	What can be done with signal output from external	12-24-1
12.25	What can be done with signal output to external	12-25-1

## 12.2 Basic setting of inverter

### 12.2.1 Change duty rating of inverter



- Want to change the duty rating mode to the one checked in selecting the mode.
- Want to lower the capacity of the inverter against the motor since the duty of the fan or pump is small.
- Want to use the inverter for a lift or others with a heavy duty.



- The duty rating mode of the inverter can be chosen from Normal Duty (ND), Low Duty (LD), and Very Low Duty (VLD). See “Difference in duty rating modes” in the following.
- The rated current, excess duty endurance, and rated temperature of the inverter could change depending on the duty rating mode.
- A change of the inverter duty rating mode is reflected immediately after the duty type [Ub-03] is changed.



- When [Ub-03] is changed, the parameter set for the electric current is automatically adjusted at the ratio of the changed rated current and the set value is changed accordingly.
- Another check is necessary if the electric current is set by using the excess duty limit function, direct current control function, electronic thermal function, excess duty warning function, or low current detection function.
- When VLD is selected and the control mode is selected out of the VLD specification range with the control type [AA121], the control mode is automatically set to the V/f control. Another check is necessary when the control type setting is changed.

**Parameters**

Item	Parameters	Data	Description
Duty Type	[Ub-03]	00	VLD (Very Low Duty)
		01	LD (Low Duty)
		02	ND (Normal Duty)

**Difference in duty rating modes**

Duty rating	ND (Normal Duty)	LD (Low Duty)	VLD (Very Low Duty)
<b>Excess duty endurance</b>	150% (1 min.) 200% (3 sec.)	120% (1 min.) 150% (3 sec.)	110% (1 min.) 120% (3 sec.)
<b>Temperature characteristics</b>	50 °C (with derating)	45°C (with derating)	40°C (with derating)
<b>Corresponding control type *)</b>	Induction motor IM <ul style="list-style-type: none"> <li>• V/f control</li> <li>• V/f control with sensor</li> <li>• SLV (sensorless vector) control</li> <li>• 0 Hz-range SLV control</li> <li>• Vector control with sensor</li> </ul> Synchronous motor SM <ul style="list-style-type: none"> <li>• SLV control</li> </ul>	Induction motor IM <ul style="list-style-type: none"> <li>• V/f control</li> <li>• V/f control with sensor</li> <li>• SLV (sensorless vector) control</li> </ul> Synchronous motor SM <ul style="list-style-type: none"> <li>• SLV control</li> </ul>	Induction motor IM <ul style="list-style-type: none"> <li>• V/f control</li> <li>• V/f control with sensor</li> <li>• SLV (sensorless vector) control</li> </ul> Synchronous motor SM <ul style="list-style-type: none"> <li>• SLV control</li> </ul>
<b>Major applications</b>	Lifts, cranes, etc. Conveyors, transportation machines, etc. Fans, pumps		

\*) Feedback option of the optional cassette is necessary for the vector control with sensor.



- The inverter rating is changed.

1 Press right (▶) key on the display screen.

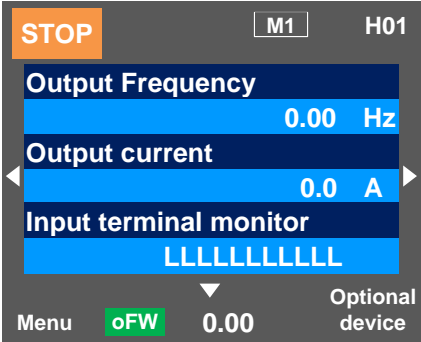

2 Press SEL(o) key twice on the parameter setting display screen and the parameter area begins blinking.

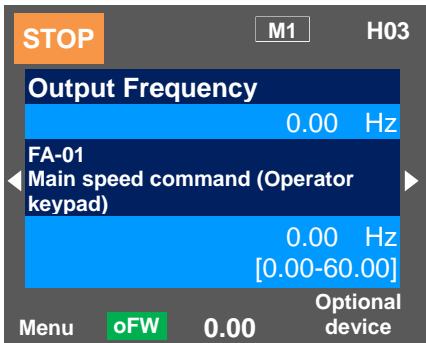

1

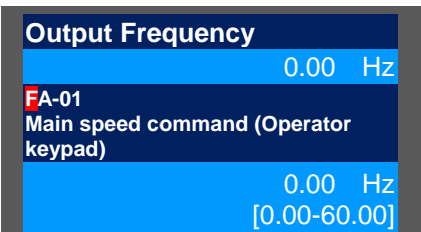
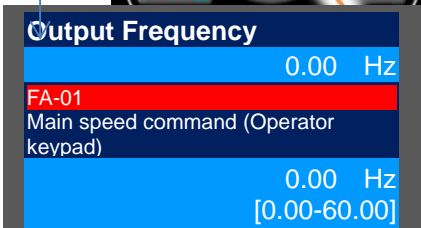

3 Use up, down, right, and left keys to choose a parameter and SEL(o) key to set it.

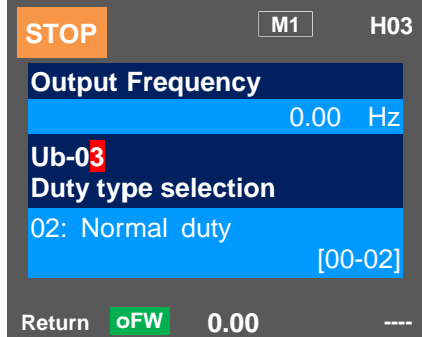

4 Use up and down keys to choose a mode and SEL(o) key to set it.

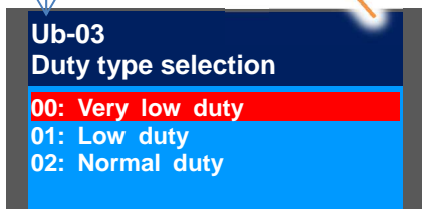
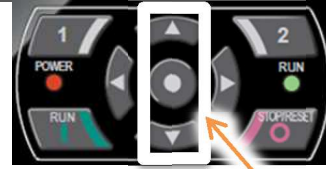
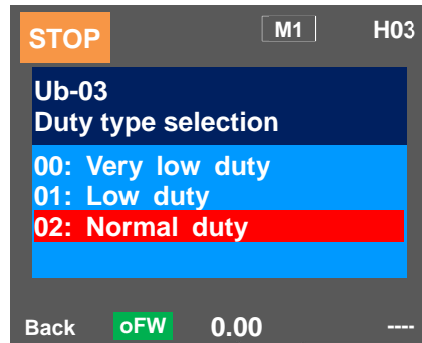

\*The change is applied and SEL(o) key is used to proceed.

5 Check the content on the previous screen. If the content is changed, the change is supposed to be stored in the storage element and the mode is switched.

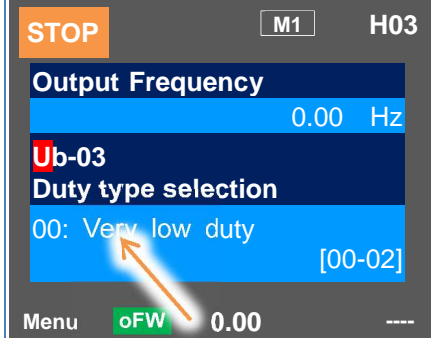

12.2.2 Initialization of inverter



- Want to initialize the setting.
- Want to return to the factory setting.
- Want to initialize the setting except the terminal block setting.
- Want to initialize the setting except the communication setting.
- Want to clear the trip history only.



- Duty type selection (Ub-03) is not initialized.
- The initialization sets the parameters to initial values. If the data before the initialization are necessary, read the data using the R/W function (Read) on the operator keypad or use PC software to save the data on a PC.



- When the initialization target [Ub-01] is chosen and [Ub-05] Start Initialization is set to 01, the designated data can be initialized to the factory setting.
- Only the trip history can be cleared without initialization of the stored parameter values.

- Initial values to be stored after the initialization can be changed by changing the initial value selection [Ub-02], For details of the modes, see a list of the parameters attached to this document.

Parameters

Item	Parameters	Data	Description
Selection of initialization	[Ub-01]	00	The initialization is disabled.
		01	The trip history and retry history are cleared.
		02	All the parameters are all initialized.
		03	The trip history, retry history, and all parameters are initialized.
		04	The trip history, retry history, all parameters, and program data for EzSQ are initialized.
		05	Parameters other than those of I/O terminal function are initialized.
		06	Parameters other than the communication function parameters are initialized.
		07	Parameters other than those of I/O terminal function and communication function are initialized.
		08	Only the program data for EzSQ are initialized.
Selection of initial values	[Ub-02]	00	Mode 0
		01	Mode 1
		02	Mode 2
		03	Mode 3
Initialization start	[Ub-05]	00	Function disabled
		01	Initialization start

Content of [Ub-01] parameters chosen for initialization

Item	Parameter range	Description
Classification of I/O terminal functions	[CA-01]~[CA-11]	Input terminal selection
	[CA-21]~[CA-31]	a/b contact selection
	[CA-41]~[CA-51]	Input terminal response
	[Cb-40]	Thermistor selection
	[CC-01]~[CC-07]	Output terminal selection
	[CC-11]~[CC-17]	a/b contact selection
	[CC-20]~[CC-33]	Output delay
	[CC-40]~[CC-60]	Logical operation function

Item	Parameter range	Description
Classification of communication functions	[CF-01]~[CF-10]	Setting of RS485 communication
	[CF-20]~[CF-38]	Setting of EzCOM communication

■ Table of initialization targets

[Ub-01] Selection of initialization:

Initialization targets are indicated by ■.

[Ub-01]	(1) History data	(2) Setting of I/O terminal	(3) Communication function	(4) Other than parameters (2) and (3)	(5) EzSQ
00					
01	■				
02		■	■	■	
03	■	■	■	■	
04	■	■	■	■	■
05			■	■	
06		■		■	
07				■	
08					■



- Example of initialization of the trip history, all the parameters, and the program data for EzSQ

1 Press right (▶) key on the display screen.



2 Press SEL(o) key twice on the parameter setting display screen and the parameter area begins blinking.

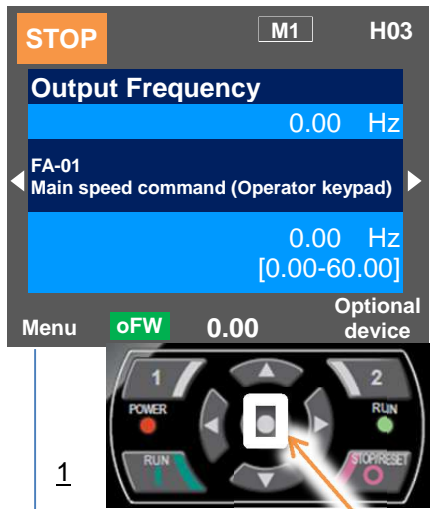

1

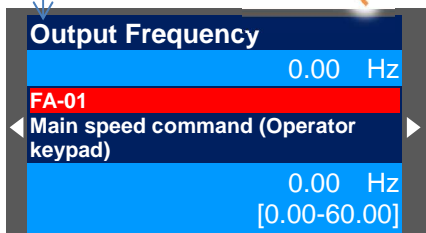

2

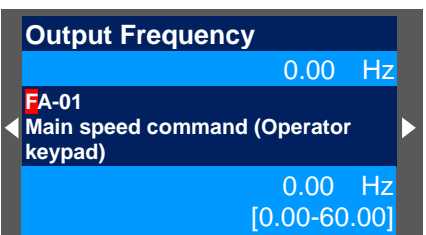

3 Use up, down, right, and left keys to choose a parameter and SEL(o) key to set it.

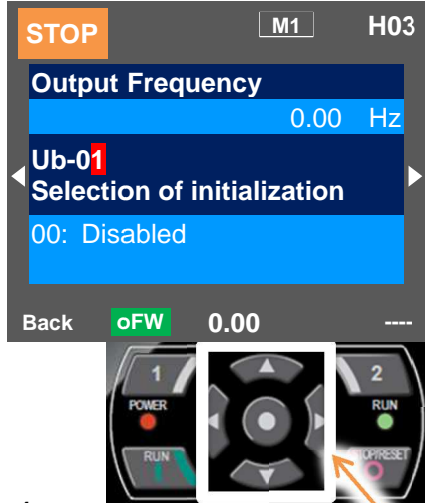

4 Use up and down keys to choose a mode and SEL(o) key to set it.

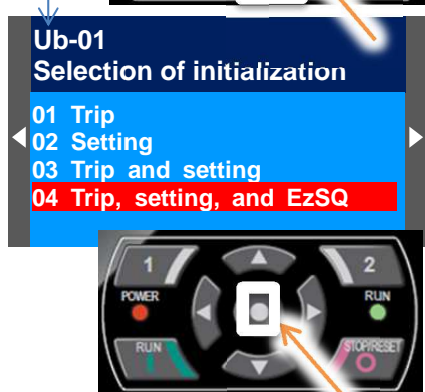
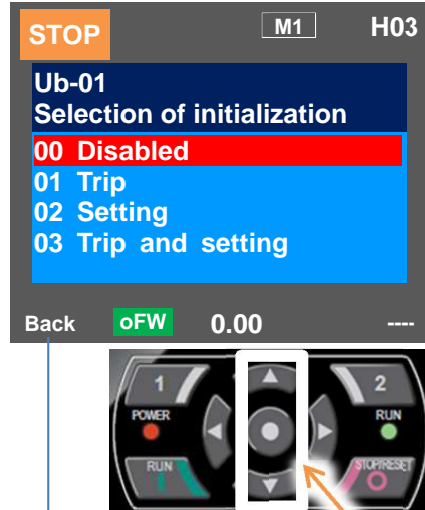

5 Check the content on the previous screen. The initialization is not done yet.

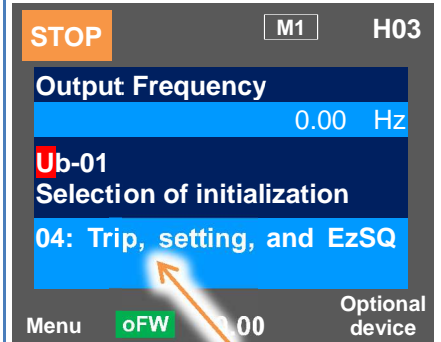

6 Next, use up, down, right, and left keys to choose [Ub-05] and SEL(o) key to set it.

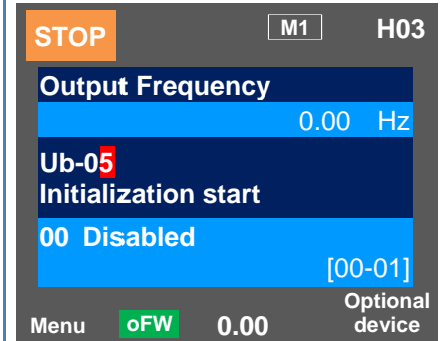

7 Choose Enabled and press SEL(o) key and initialization begins.

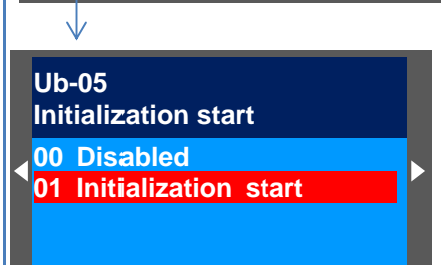
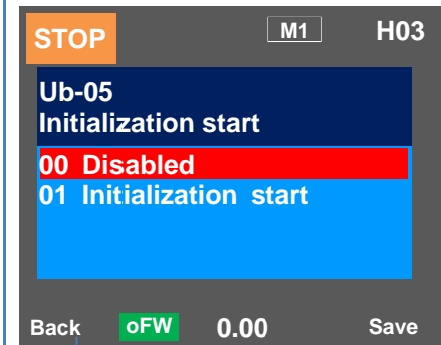

8 Initialization is on-going.



9 初期化完了！画面となります。

(Memo)

## 12.3 Basic setting of motor

### 12.3.1 Parameter setting of motor rating data



- Want to make setting suitable for the motor.
- Unstable motor operation



- Basic parameters to control and protect the motor are set.
- The following basic parameters need to be set for any control type.
- The motor operation could be stabilized if the motor items are set to the inverter.
- The induction motor (IM) and synchronous motor (SM) / permanent magnet motor (PMM) are set separately.

#### ■ About induction motor (IM)

Items of Induction motor	Parameters of inverter		Setting range (unit)	Description
Capacity	[Hb102]	Selection of motor capacity	0.01~160.00 (kW)	Sets the motor capacity.
Number of motor poles	[Hb103]	Selection of number of motor poles	2-48 (poles)	Sets the number of motor poles.
Frequency	[Hb104]	Base frequency	10.00~590.00 (Hz)	Sets the base frequency of motor.
	[Hb105]	Max. frequency	10.00~590.00 (Hz)	Sets the max. frequency of motor.
Voltage	[Hb106]	Rated voltage of motor	1~1000 (V)	Sets the rated voltage of motor.
Current	[Hb108]	Rated current of motor	0.01~10000.00 (A)	Sets the rated current of motor.

#### ■ About synchronous motor (SM) / permanent magnetic motor (PMM)

Items of PM motor	Parameters of inverter		Setting range (unit)	Description
Capacity	[Hd102]	Selection of motor capacity	0.01~160.00 (kW)	Sets the motor capacity.
Number of poles	[Hd103]	Selection of number of poles	2-48 (poles)	Sets the number of poles.
Frequency	[Hd104]	Base frequency	10.00~590.00 (Hz)	Sets the base frequency of motor.
	[Hd105]	Max. frequency	10.00~590.00 (Hz)	Sets the max. frequency of motor.
Voltage	[Hd106]	Rated voltage of motor	1~1000 (V)	Sets the rated voltage of motor.
Current	[Hd108]	Rated current of motor	0.01~10000.00 (A)	Sets the rated current of motor.





The motor could burn if the base frequency is set smaller than the motor frequency. (Smaller than 50 Hz in case of standard induction motor)



The motor could burn if the max. frequency and rated voltage are set out of the range specified in the motor specifications.



For setting the max. frequency larger than 60 Hz, contact the motor manufacturer about allowed max. frequency.



After initialization, the motor protection function needs to be configured again. Otherwise, the motor could burn.

#### ■ Capacity and number of poles

**A**

- The inverter reads out preset standard motor data if the capacity and number of poles are changed.
- The motor disturbance could be suppressed and the motor operation could be stabilized if the capacity and number of poles are correctly set.

#### ■ Base frequency

**A**

- Set the base frequency according to the motor specifications.



- The induction motor should be regarded as a special one if used at higher than 60 Hz. In this case, the inverter capacity may need to be made larger as the maximum capacity of the inverter motor is incorrect.

#### ■ Max. frequency

**A**

- Sets the max. frequency of motor to use.

#### ■ Rated voltage

**A**

- Set the rated voltage of motor according to the motor specifications.



- Expected characteristics may not be obtained if the motor rated voltage is set higher than receiving voltage or inverter rated voltage.
- Set the rated voltage of motor in the following way if it is switched from SJ700.  
[Hb106]=A082xA045/100

#### ■ Rated current

**A**

- Set the rated current of motor according to the motor specifications. Inappropriate setting could disturb the motor protection.
- The motor control could become unstable unless the motor rated current is correctly set.



- Expected characteristics may not be obtained if the motor rated current is set higher than the inverter rated current. In some cases, the inverter protection works first.

■ Automatic voltage regulation function (AVR function)

**A**

- The inverter automatically operates the automatic voltage regulation function (AVR function). This function outputs voltage to the motor correctly even with variation in the input voltage to the inverter.
- Output of a voltage larger than the input voltage is not allowed even using this function.

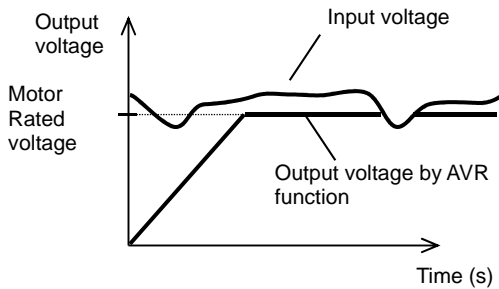

**A**

- To use operation with conventional AVR function being set OFF, make the setting in [bA146] over-excitation function selection.
- [bA146]=02 for AVR OFF during deceleration.
- [bA146]=01 for AVR OFF all time.

■ Relation between frequency and voltage under general V/f control (IM)

**A**

- General V/f control command is given in the following with the base frequency and rated voltage being set.
- At the frequency in the range from the base to max. frequency, the output voltage reaches a max. of the rated voltage of motor.

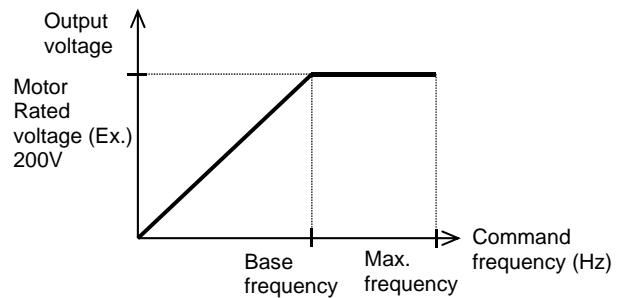

■ Control of general synchronous motor

**!**

- Basically the synchronous motor needs current calculation control and the motor parameters need to be set. The parameters in this item and motor constants in the next item need to be set.

### 12.3.2 Motor constant setting

Q

- Unstable motor operation
- Want to use a motor other than Hitachi's.
- Want to use the vector control function.
- Want to use the automatic boost function.

!

- Note that the motor constants will be overwritten if any of the following actions is taken. This applies to both IM and SM (PMM).
  - The motor capacity or number of motor poles is changed.
  - The auto-tuning is performed.
  - The initialization is performed.

Please be advised to save the constants using the R/W function on the operator keypad VOP.

- For details of adjustment, see "12.9,1 Control mode selection".

A

- The motor operation could be stabilized if the following operations are made.
- In particular, the motor constants need to be set according to the motor specifications when the automatic boost function, automatic boost function with sensor, sensorless vector control function, 0 Hz-range sensorless vector control function, or vector control function with sensor is used.
- The motor constants of Hitachi's standard motor are automatically set to the followings when the motor capacity or number of motor poles is changed.
- Some of the motor constants in the followings are automatically set to acquired constant data when the auto-tuning function is used. For details, see the next section.
- The motor constants can be chosen from the motor constant selection or manually changed or adjusted.
- Hitachi's IE3 motor constants are used as initial values of the induction motor (IM) constants.

#### ■ IM motor constant parameters

Item	Parameters	Data	Description
Motor constant R1	[Hb110]	0.000001~1000.000000(Ω)	Sets the primary resistance of IM.
Motor constant R2	[Hb112]	0.000001~1000.000000(Ω)	Sets the secondary resistance of IM.
Motor constant L	[Hb114]	0.000001~1000.000000(mH)	Sets the leakage inductance of IM.
Motor constant I0	[Hb116]	0.01~10000.00(A)	Sets the no-load current of IM.
Motor constant J	[Hb118]	0.00001~10000.00000(kg <sup>m</sup> <sup>2</sup> )	Sets the moment of inertia of the system.

!

- Set the motor constant I0 in the following way if it is switched from SJ700.  
[Hb116]=(50Hz/A003)×H023 (or H033)

- 基底周波数を変更した場合、モータ定数 I0 の基準値が変わり、変更ありと見なされます。(設定値は維持されます)。正しい値をオートチューニングで取得するか、日立の誘導モータ(IM)の初期値を呼び出す場合には、[Hb103]極数選択を別の値、例えば、一旦4極を2極にし、再び4極に設定することで変更された後の基底周波数に対応するデータが[Hb116]モータ定数 I0 に設定されます。

## ■ SM/PMM motor constant parameters

Item	Parameters	Data	Description
Motor constant R	[Hd110]	0.000001~1000.000000( $\Omega$ )	Sets the resistance of SM/PMM.
Motor constant Ld	[Hd112]	0.000001~1000.000000(mH)	Sets the d-axis inductance of SM/PMM.
Motor constant Lq	[Hd114]	0.000001~1000.000000(mH)	Sets the q-axis inductance of SM/PMM.
Motor constant Ke	[Hd116]	0.1~100000.0(mVs/rad)	Sets the calculated value of induced voltage of SM/PMM.
Motor constant J	[Hd118]	0.00001~10000.000000(kgm <sup>2</sup> )	Sets the moment of inertia of the system.



- The base (max.) frequency can be calculated from the rated number of revolutions of the motor ( $\text{min}^{-1}$ ) and the number of poles in the following formula.  
Base (max.) frequency (Hz) = rated number of revolutions ( $\text{min}^{-1}$ )  $\times$  number of poles (pole)/120
- The motor constant Ke is the peak value of the phase induced voltage (mV) per electrical angular speed (rad/s).

### 12.3.3 Auto-tuning of motor



- Want to use a motor other than Hitachi's.
- Unstable motor operation
- The adjusted motor environment has changed.
- The wiring was changed from the one used in the trial operation.
- The motor and wires were replaced



- The auto-tuning is a function that measures and automatically sets the motor constants necessary for the motor control.
- There are two types of auto-tuning functions: Offline auto-tuning where the auto-tuning function finishes after a single measurement and online auto-tuning where the auto-tuning function measures a change in the constants due to motor temperature increase every time the motor is started or stopped.
- Use the offline auto-tuning to measure the motor constants if you use a motor whose constants are unknown.
- The online auto-tuning can stabilize the motor behavior by correcting the temperature increase of the motor during operation.

■ Parameters

Item	Parameters	Data	Description
Auto-tuning selection	[HA-01]	00	Function disabled
		01	Non-revolving auto-tuning is performed. After this parameter is set, an operation command starts the tuning.
		02	Revolving auto-tuning is performed. After this parameter is set, an operation command starts the tuning.
		03	The tuning for the IVMS control type is performed. After this parameter is set, an operation command starts the tuning.
Operation command for auto-tuning	[HA-02]	00	RUN key on the operator keypad
		01	Command is sent from the designated operation commander.
Online tuning selection	[HA-03]	00	Function disabled
		01	The online tuning is performed. The online tuning is automatically performed after the deceleration stops in ordinary operations.





- When 02 (revolving) is chosen in the auto-tuning selection [HA-01], the motor automatically begins rotating when the tuning starts. Make sure of the followings.
  - No problem shall occur even with the rotation at a frequency close to 80% of the base frequency.
  - The motor shall not be driven from external.
  - The braking shall be in the open state.





- The torque is not high enough during the auto-tuning. Lift or other machine could have unexpected slipping. Remove the motor from the loading machine and perform the auto-tuning to the independent motor. (In this case, the moment of inertia J is that of the independent motor and hence the moment of inertia of the loading machine should be converted to the value about the motor axis and added to J.)





- For a machine with limited motor axis rotation (lift, ball screw, etc.), 01 (non-revolving) should be chosen in [HA-01] since rotation higher than the allowed one could occur causing a damage to the machine.





- The constants of Hitachi's standard induction motor (IE3 motor) are used as default in the factory setting. If you use Hitachi's standard induction motor, expected characteristics will be achieved without offline auto-tuning in most cases .
- Smooth tuning could be done if the offline auto-tuning is first performed for the factory-set parameters.
- If you use a synchronous motor SM (or permanent magnet motor PMM), perform the tuning after the control type [AA121] is set to 11 (SM/PMM: Synchronous activation) or 12 (SM/PMM: IVMS activation).
- If expected characteristics cannot be achieved, adjust the parameters and motor constants.
- Perform the offline auto-tuning before using the online auto-tuning function.
- The motor constants are for a single phase of Y-connection.
- The offline auto-tuning is performed only when the operation can be made.
- If no-load current is not known, check the current in the operation at the base frequency with the V/f control by using an electric current monitor and enter the value to [Hb116] before the auto-tuning.
- Even if 01 (non-revolving) is chosen for [HA-01], the motor could rotate slightly.
- The offline auto-tuning automatically overwrites the parameters with acquired data. The online auto-tuning does not overwrite the parameters with the data as it corrects internal data.

■ Parameter data overwritten in the offline auto-tuning

Selection of IM/SM	Parameters to be overwritten	
	Non-revolving tuning [HA-01]=01	Revolving tuning [HA-01]=02
Induction motor (IM) control [AA121]=00~10	[Hb110] Motor constant R1 [Hb112] Motor constant R2 [Hb114] Motor constant L	[Hb110] Motor constant R1 [Hb112] Motor constant R2 [Hb114] Motor constant L [Hb116] Motor constant I0 [Hb118] Motor constant J
Control of synchronous motor (permanent magnetic motor) (SM (PMM)) [AA121]=11~12	[Hd110] Motor constant R [Hd112] Motor constant Ld [Hd114] Motor constant Lq	-

\*The above table shows the case where [SET] terminal is OFF or not selected. If [SET] terminal is made ON and the secondary setting is used, the parameters of [H\*21\*] ([Hb210], [Hd210], etc.) are effective and overwritten according to the selection of the control type [AA221].

■ IVMS auto-tuning



- If a high torque is necessary for activation, Hitachi's original IVMS control is used. If 03 is chosen for the auto-tuning selection [HA-01], it can be detected whether the target motor can be driven with the IVMS control, although combination check should be made in advance. Contact our sales personnel.
- The tuning with the IVMS control should be performed on an independent motor with the control type [AA121] set to 12 (SM/PMM: IVMS activation).
- In case of failure of the auto-tuning with the IVMS control, data necessary for the IVMS control cannot be obtained from the motor and the control type [AA121] should be set to 11 (SM/PMM: Synchronous activation) to drive the motor.



## Offline auto-tuning

1

Check the control type [AA121].

For the induction motor (IM), make sure that the control type [AA121] is set to the one for IM. For the synchronous motor (SM) or permanent magnetic motor (PMM), make sure that the control type [AA121] is set to the one for PMM.

2

Set the auto-tuning selection [HA-01].

In the auto-tuning selection [HA-01], 01: Non-revolving or 02: Revolving is set. The tuning does not begin at this stage. Only "non-revolving" can be chosen for synchronous motor (SM) / permanent magnetic motor (PMM).

3

Set a start command for tuning.

Pressing OPERATION button on the operator keypad starts the tuning, Pressing STOP button terminates the tuning, However tuning data are not saved.

4

The inverter automatically operates.

Output of a preset pattern is given to the motor. If the auto-tuning selection [HA-01] is set to 01: Non-revolving, non-revolving output of three different patterns is given.

If the auto-tuning selection [HA-01] is set to 02: Revolving, acceleration and deceleration are repeated twice in addition to the above output. The frequency increases up to 80% of the base frequency.

After the above operation finishes, the output with no revolution is checked as final check.

5

The tuning finished.

When the tuning End display appears, the tuning finishes. Use STOP key to cancel the End display.



## Online auto-tuning

1

Perform the offline auto-tuning.

The online auto-tuning works with the designated motor constants and the offline auto-tuning described on the left is performed.

2

The online tuning selection [HA-03] is set.

Set the online tuning selection [HA-03] to 01: Enabled.

3

Check the online auto-tuning.

The online tuning operates for up to 5 s when every operation stops. Use the online tuning after making sure that the operation and stop can be made correctly by your operation command.



- In case of termination due to trip or erroneous tuning, correct data cannot be acquired. See the next section.
- The result of the online tuning is automatically reflected in up to 5 s after the stop. It is not reflected if the operation is restarted during the tuning.
- The online tuning is not performed if the servo-on function [SON] or forcing function [FOC] is working.
- In the factory setting, the offline auto-tuning can be started by the operation key on the operator keypad. It can be changed to a designated operation command by changing the operation command [HA-02] of the auto-tuning.

■ Tuning failure during auto-tuning.

Expected causes▶	Examples of measures
<ul style="list-style-type: none"> <li>The control type is not suitable for the motor.</li> </ul>	<ul style="list-style-type: none"> <li>Since the tuning type changes depending on the control type [AA121], IM control or SM/PMM control, set the type in accordance with the motor.</li> </ul>
<ul style="list-style-type: none"> <li>The base frequency, motor rated voltage, or motor rated current is not suitable for the motor specifications.</li> </ul>	<ul style="list-style-type: none"> <li>Since wrong basic parameters of the motor could cause excess current or trip, check the basic parameters and set them appropriately.</li> </ul>
<ul style="list-style-type: none"> <li>STOP key was pressed.</li> </ul>	<ul style="list-style-type: none"> <li>Pressing the STOP key on the operator keypad interrupts the auto-tuning. Check the setting of the auto-tuning again before starting the tuning.</li> </ul>
<ul style="list-style-type: none"> <li>External factors such as braking caused a trip.</li> </ul>	<ul style="list-style-type: none"> <li>Factors that cause the trip need to be removed.</li> </ul>
<ul style="list-style-type: none"> <li>The input terminal function worked.</li> </ul>	<ul style="list-style-type: none"> <li>The tuning could be disturbed if the input terminal function works during the auto-tuning.</li> </ul>
<ul style="list-style-type: none"> <li>The motor capacity is too small compared to the one set for the inverter.</li> </ul>	<ul style="list-style-type: none"> <li>If the tuning does not finish correctly, the motor constants need to be set manually.</li> </ul>



- In case of failure of the auto-tuning, the motor constant data are not updated and the motor works in the untuned state.





12.4 Select a frequency command.

12.4.1 Type of frequency command



- The frequency command selected in each function is enabled.
- For details, see the next and subsequent sections.
- The value of the enabled frequency command is shown in [FA-01]. If the frequency command can be modified on the operator keypad, the modification is made by changing [FA-01] when, for example, [AA101]=07 is effective. ([Ab110] is overwritten when [FA-01] is changed.)



- The operation of the inverter requires not only a frequency command but also an operation command.
- To use the second setting switching [SET] of the input terminal function, replace 1 of the third digit of the parameter with 2. Ex.: [AA101]->[AA201]. If the third digit is “-”, the parameter is shared for the first and second settings.

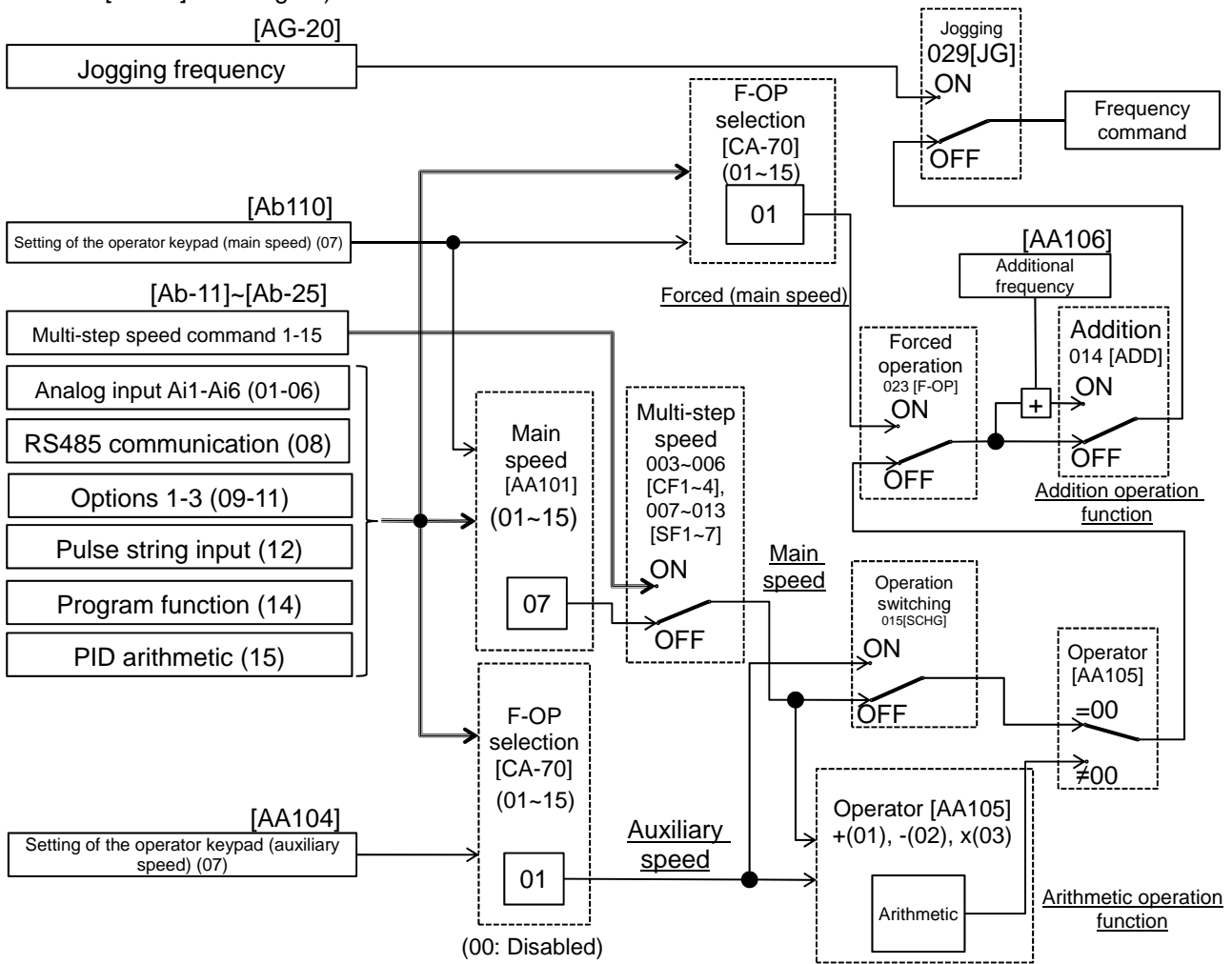

- In the above example, [AA101]=07 (operator keypad) is enabled. For details, see the following explanation.
- Other command destinations can be chosen even when RS485 (Modbus communication, EzCOM function) and program function (EzSQ) are being used.

- If an operation command is given from the operation screen of PC software ProDriveNext, [AA101]=07 and [AA111]=03 are forcibly overwritten when the operation screen opens. When the operation screen closes, the values returned to the ones used before the screen opened.
- Functions not assigned to the input terminal functions [CA-01]-[CA-11] become OFF.

12.4.2 Operation on operator keypad



- Want to change the frequency from the operator keypad for trial operation.
- Want to change the frequency while watching it on the monitor.
- Want to change the frequency from the operator keypad.



- The operator keypad is used to give a frequency command.
- For operation using the operator's keypad, the operation direction can be changed by setting RUN key direction selection [AA-12].



- The output of the inverter (operation of the motor) requires not only a frequency command but also an operation command.
- The main and auxiliary speeds can be selected and calculated by using the input terminal function [SCHG] and the operator selection. For details, see "12.4.9 Selecting and calculating two commands to make a command"
- If not using the operator keypad, you need to make FW/RV direction switching from each command.

■ Parameters

Item	Parameters	Data	Description
Main speed command selection	[AA101]	07	The frequency set from the operator keypad is for main speed In this case the setting is made for [Ab110].
Auxiliary speed command selection	[AA102]	07	Auxiliary speed to use switching and arithmetic functions is set from the operator keypad. For auxiliary speed, the setting is made for [AA104].
0th speed of the 1st multi-step speed	[Ab110]	0.00~590.00(Hz)	Frequency setting of the main speed on the operator keypad. Shared for the 0th speed of the multi-step speed function.
Auxiliary speed setting	[AA104]	0.00~590.00(Hz)	Frequency setting of the auxiliary speed on the operator keypad.
RUN key direction selection	[AA-12]	00	Forward rotation operation
		01	Reverse rotation operation
Output terminal function	[CC-01] ~ [CC-07]	010	[FREF] ON when a frequency command can be given from the operator keypad.

**12.4.3** Operation with analogue signal from terminal block

■ Enabling frequency command from terminal block



- Want to give a frequency command from an external device.
- Want to use a frequency setter to change the frequency.
- Want to connect a variable resistor to change the frequency.



- A frequency command is given by input from the terminal block.
- The inverter has three kinds of external analogue input.

Terminal connection	Input range	Switching method
Ai1-L	0-10 V/0-20 mA switchable	SW1 on the board is switched.
Ai2-L	0-10 V/0-20 mA switchable	SW2 on the board is switched.
Ai3-L	-10~10V	-

- For each input, relation between the input signal and the frequency command can be set independently. See “12.24 Things that can be done with external signal input.”
- To add/subtract a command, the auxiliary speed command [AA102] and operator [AA105] should also be set. [Ai3] can be added to [Ai1] and [Ai2] without choosing an operator in the [Cb-22][Ai3] terminal selection. For details, see “12.24 Things that can be done with external signal input.”

■ Parameters

Item	Parameters	Data	Description
Main speed command selection	[AA101]	01	Input between Ai1 and L enabled.
		02	Input between Ai2 and L enabled.
		03	Input between Ai3 and L enabled.
		04	Input between Ai4 and L enabled. *1)
		05	Input between Ai5 and L enabled. *1)
		06	Input between Ai6 and L enabled. *1)

\*1) Optional P1-AG is necessary.



- The output of the inverter requires not only a frequency command but also an operation command.
- Note that the voltage input and the current input are switched from each other by the terminal block switch.
- For adjustment of the analogue input, see “12.24 Things that can be done with external signal input.”



- First, the voltage SW and current SW are switched when the wiring is made.

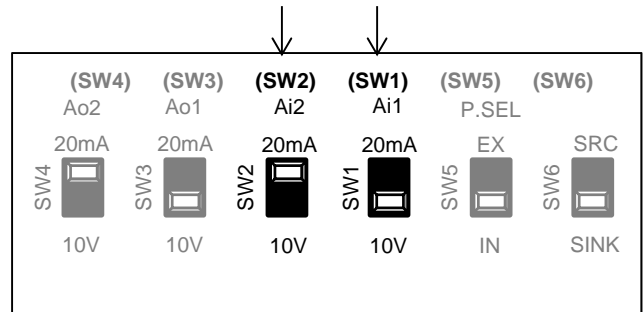

- Next, a command destination for the parameter [AA101] is set.

**12.4.4** Command from RS485 communication



- Want to use RS485 communication to give a frequency command.



- For details, see “Chapter 14 RS485 Communication”.



- RS485 communication is used to give a frequency command.

■ Parameters

Item	Parameters	Data	Description
Main speed command selection	[AA101]	08	Command from RS485 communication

**12.4.5** Command from optional cassette



- Want to use the optional board to give a frequency command.



- For the frequency commands, refer to the instruction manual provided together with each optional cassette.



- Optional device is used to give a frequency command.
- An option from which a command is received is chosen from multiple options.

■ Parameters

Item	Parameters	Data	Description
Main speed command selection	[AA101]	09	Frequency commands from optional cassette in slot 1 enabled.
		10	Frequency commands from optional cassette in slot 2 enabled.
		11	Frequency commands from optional cassette in slot 3 enabled.

**12.4.6** Making command from pulse string input

■ Input terminals [A] and [B] of the main body are used.



- Want to make a frequency command from the frequency given in a pulse string of the open collector.



- To use the input terminals [A] and [B] of the main body as a pulse string input frequency command, set [CA-90] to be 01: command.
- A pulse string given as input to the input terminals [A] and [B] of the inverter is used.
- A pulse string given as input to the input terminals [A] and [B] can be used as a frequency command / PID feedback value in each control mode.
- Set an input pulse frequency that corresponds to the maximum frequency to the pulse string frequency scale [CA-92].
- The pulse string input values to the input terminals [A] and [B] can be monitored with [dA-70].

■ Parameters (main body)

Item	Parameters	Data	Description
Main speed command selection	[AA101]	12	Frequency command from pulse string input (input terminals [A] and [B])
Pulse string input (main body) detection target selection	[CA-90]	01	Used for frequency command
Pulse string input (main body) mode selection	[CA-91]	00	Mode 0: 90° phase difference pulse string
		01	Mode 1: Forward/Reverse rotation command and rotation direction
		02	Mode 2: Forward rotation pulse string and reverse rotation pulse string
Pulse string frequency (main body) scale	[CA-92]	0.05~32.00 (kHz)	Input a pulse string frequency that corresponds to the maximum frequency.
Pulse string frequency (main body) filter time constant	[CA-93]	0.01~2.00 (sec)	A filter is applied to the input of the pulse string frequency.
Pulse string frequency (main body) bias size	[CA-94]	-100.0~100.0(%)	A bias is applied to the input of the pulse string frequency.
Pulse string frequency (main body) upper detection limit	[CA-95]	0.0~100.0 (%)	The output of the pulse string frequency input is limited.
Pulse string frequency (main body) lower detection limit	[CA-96]	0.0~100.0 (%)	In outputting the pulse string frequency input, pulses with the frequency lower than the limit is set to 0.0%.

■ Monitor (main body)

Item	Parameters	Data	Description
Pulse string input monitor (main body)	[dA-70]	-100.00~100.00(%)	The frequency command from the pulse string input (input terminals A/B) is displayed.

\*To give a pulse string input frequency command, there are two methods. One is to use the main body's terminals and the other is to use the optional P1-FB.



- Start/End function of analogue input cannot be used. To limit the pulse string input frequency, use the pulse string frequency bias size [CA-94], the pulse string frequency upper detection limit [CA-95], and the pulse string frequency lower detection limit [CA-96]
- When the pulse input frequency is below the pulse string frequency lower detection limit [CA-96], it is regarded as 0 Hz in the processing.
- Slow start if the pulse string frequency lower detection limit [CA-96] is set to a high value.

- Internal arithmetic block diagram  
Internal processing is schematically drawn.

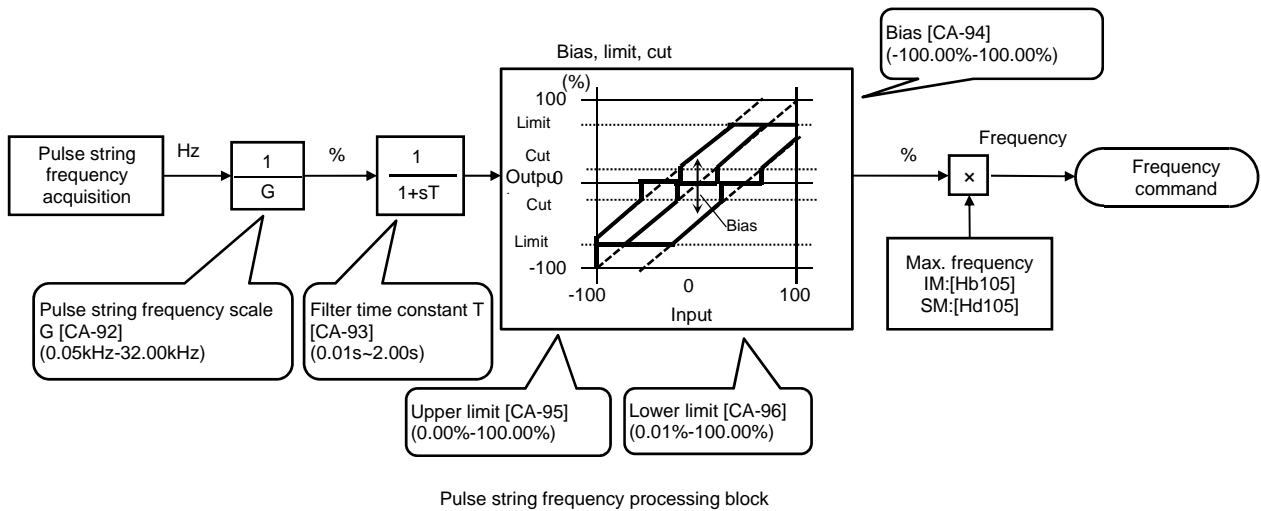

- For details of the pulse string input mode, see below.  
Command frequency is determined by the frequency of the pulse string input.  
The sign of the command frequency is determined in the following way.

(1) Mode 0: [CA-91]=00 90° phase difference pulse string

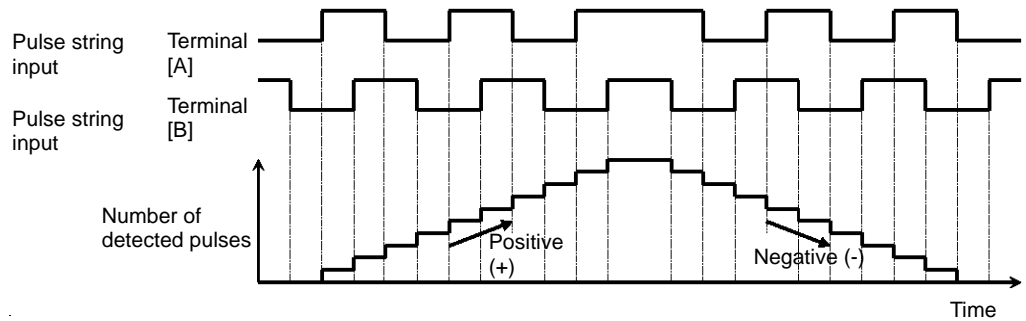

(2) Mode 1: [CA-91]=01 forward and reverse rotation

commands + pulse string

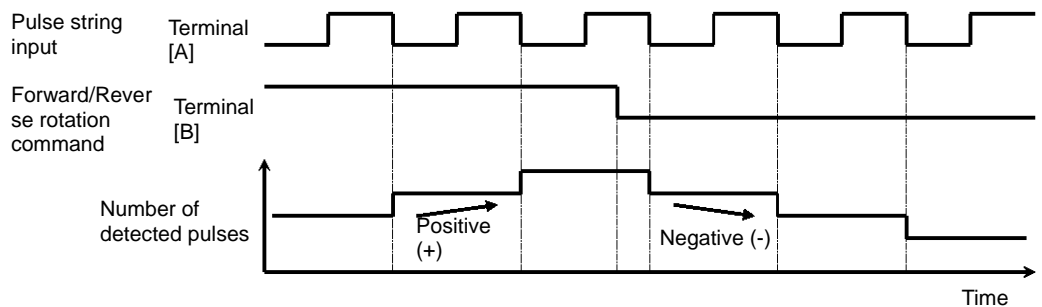

(3) Mode 2: [CA-91]=02

Forward rotation pulse string + reverse rotation pulse string

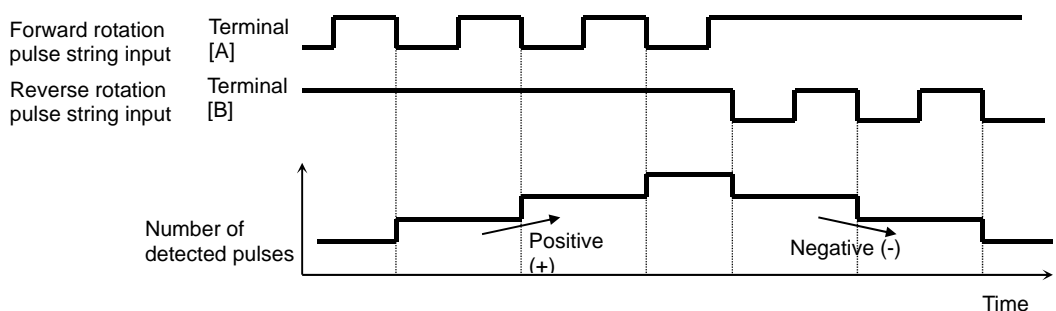

■ Use of optional cassette P1-FB



- Want to make a frequency command from the frequency given in a pulse string of the line driver.



- The pulse string given in [SAP][SBP][SAN][SBN] of the optional cassette P1-FB (feedback option) is used.
- A pulse string given as input to P1-FB can be used as a frequency command / PID feedback value in each control mode.
- Set an input pulse frequency that corresponds to the maximum frequency to the pulse string frequency scale [ob-12].
- The pulse string input values to P1-FB can be monitored with [dA-71].



- Start/End function of analogue input cannot be used. To limit the pulse string input frequency, use the pulse string frequency bias size [ob-14], the pulse string frequency upper detection limit [ob-15], and the pulse string frequency lower detection limit [ob-16]
- When the pulse input frequency is below the pulse string frequency lower detection limit [ob-16], it is regarded as 0 Hz in the processing.
- Slow start if the pulse string frequency lower detection limit [ob-16] is set to a high value.

■ Parameters (main body)

Item	Parameters	Data	Description
Main speed command selection	[AA101]	13	Frequency command from optional P1-FB enabled.
Pulse string input (option) detection target selection	[ob-10]	01	Used for frequency command
Pulse string input (option) mode selection	[ob-11]	00	Mode 0: 90° phase difference pulse string
		01	Mode 1: Forward/Reverse rotation command and rotation direction
		02	Mode 2: Forward rotation pulse string and reverse rotation pulse string
Pulse string frequency (option) scale	[ob-12]	0.05~200.0 (kHz)	A pulse string frequency equivalent to the maximum frequency is given.
Pulse string frequency (option) filter time constant	[ob-13]	0.01~2.00 (sec)	A filter is applied to the input of the pulse string frequency.
Pulse string frequency (option) bias size	[ob-14]	-100.0~100.0(%)	A bias is applied to the input of the pulse string frequency.
Pulse string frequency (option) upper detection limit	[ob-15]	0.0~100.0 (%)	The output of the pulse string frequency input is limited.
Pulse string frequency (option) lower detection limit	[ob-16]	0.0~100.0 (%)	In outputting the pulse string frequency input, pulses with the frequency lower than the limit is set to 0.0%.

■ Monitor (main body)

Item	Parameters	Data	Description
Pulse string input monitor (option)	[dA-71]	-100.00~100.00(%)	Frequency command from pulse string input (option input A phase / B phase)



Internal arithmetic block diagram  
Internal processing is schematically drawn.

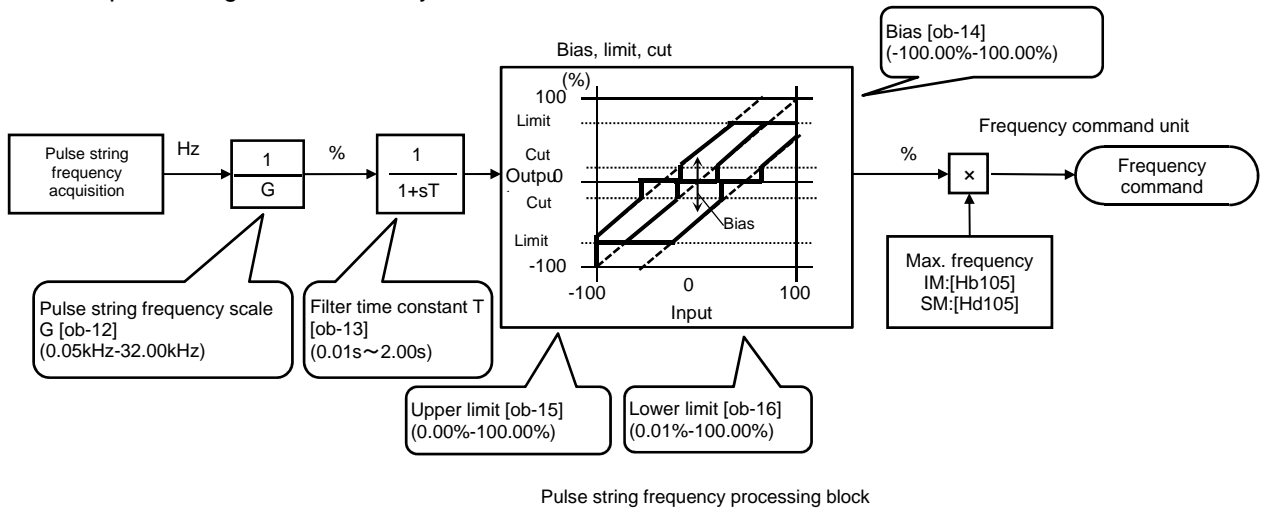

For details of the pulse string input mode, see below.  
Command frequency is determined by the frequency of the pulse string input.  
The sign of the command frequency is determined in the following way.

(1) Mode 0: [ob-11]=00 90° phase difference pulse string

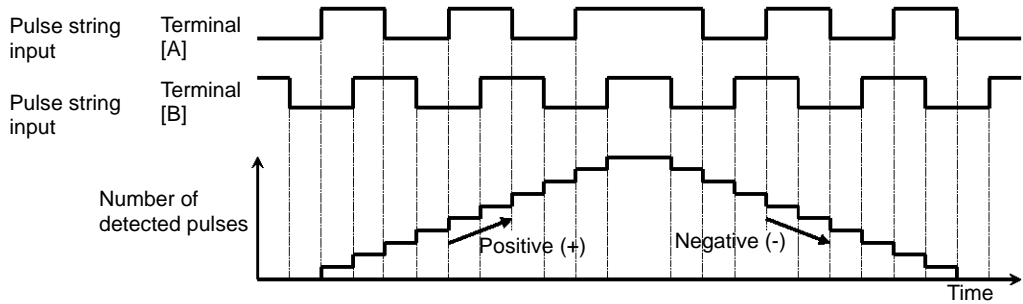

(2) Mode1:[ob-11]=01 Forward and reverse commands  
+ pulse string

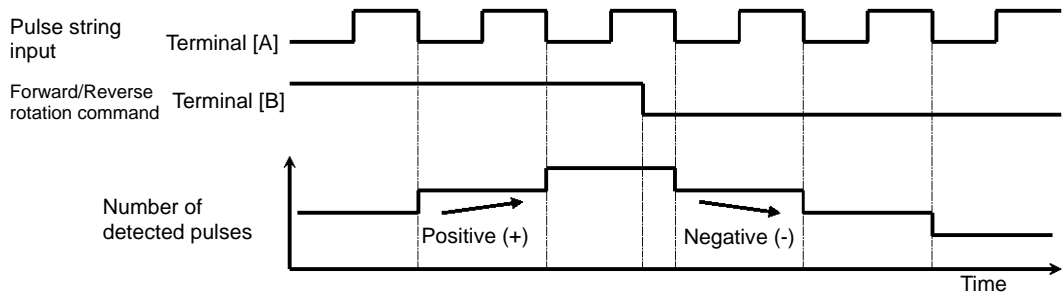

(3) Mode 2: [ob-11]=02 Forward rotation pulse string  
+ reverse rotation pulse string

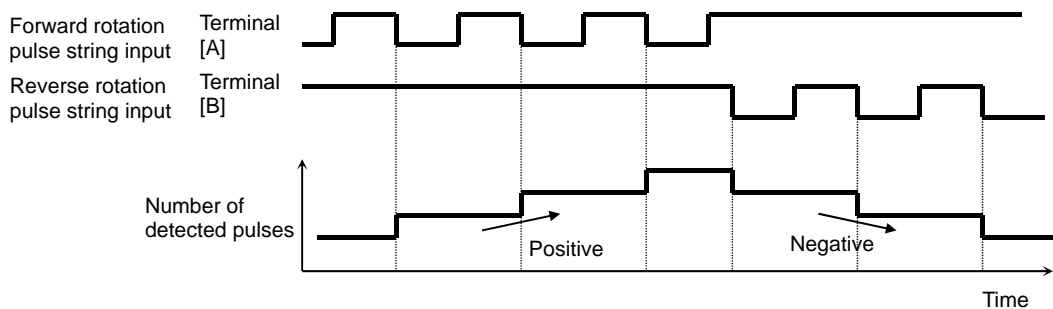

**12.4.7** Command by sequence control (EzSQ)



- Want to use Set-Freq to make a command in the EzSQ function which is set from a PC.



- A frequency command can be made through the code programmed in EzSQ if Set-Freq is used in the EzSQ programming and the frequency command is set from EzSQ.



- A program created on PC needs to be downloaded from the PC to the inverter.
- Downloaded program begins working when the program action of the EzSQ function is enabled.
- For details, see the instruction manual of EzSQ.

■ Parameters

Item	Parameters	Data	Description
Main speed command selection	[AA101]	14	Frequency command from the program function EzSQ enabled.
EzSQ function selection	[UE-02]	00	Actions of the downloaded programs disabled.
		01	The program starts when [PRG] terminal is made ON.
		02	The program starts after the setting or power activation.

**12.4.8** Command by PID control



- Want to use PID control to control a fan or pump.
- Want to use process control.



- To use the PID control for motor control, PID arithmetic is set in the frequency command selection after the PID function is set.



- To give a command from the PID control, parameters of the PID control function need to be set. For details, see “12.10 Process control in accordance with system.”

■ Parameters

Item	Parameters	Data	Description
Main speed command selection	[AA101]	15	An arithmetic result of the PID control is output.

**12.4.9** Selecting and calculating two commands to make a command



- Want to multiply gain to the command frequency.
- Want to make a command with two input values summed up.
- Want to subtract a command to make forward/reverse rotation.
- Want to switch two commands.



- By selecting an operator, one can either switch between main speed and auxiliary speed ([SCHG] switching with [AA105]=00) or make a command (arithmetic frequency) ([AA105] not equal to 00) on the basis of addition, subtraction, or multiplication of the two speeds.

■ Parameters

Item	Parameters	Data	Description
Main speed command selection	[AA101]	01~15	01: Ai1-L input, 02: Ai2-L input, 03: Ai3-L input, 07: parameter setting, 08: RS485 communication, 12: pulse string input (main body), 14: program function EzSQ, 15: PID arithmetic, 00: disabled (only for auxiliary speed)
Main speed command selection	[AA102]		
Operator selection	[AA105]	00	The arithmetic function is disabled and can be switched by using the [SCHG] terminal.
		01	(Main speed) + (auxiliary speed) is used for the command.
		02	(Main speed) - (auxiliary speed) is used for the command.
		03	(Main speed) x (auxiliary speed) is used for the command.
Input terminal function	[CA-01]~[CA-11]	015	[SCHG] Main speed and auxiliary speed are switched from each other for the operation. OFF: Main speed is effective, ON: Auxiliary speed is effective. *) The operator needs to be [AA105]=00.

■ Operating two commands

(Ex. 1) Gain is multiplied.

[AA101]=01 (Ai1 command)/[AA102]=07 (set [Ab110])/ [AA105]=03 (multiplication)/[Ab110]=3.00(Hz)

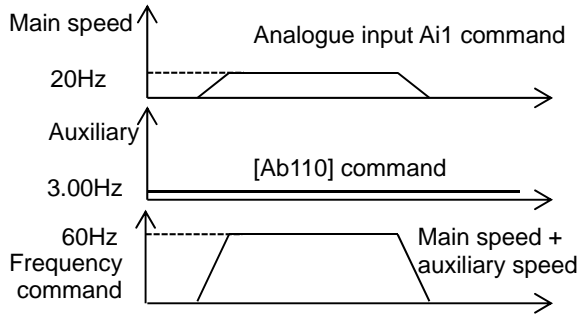

(Ex. 2) Command by addition

[AA101]=01 (Ai1 command)/[AA102]=02 (set [Ab110])/ [AA105]=01 (addition)

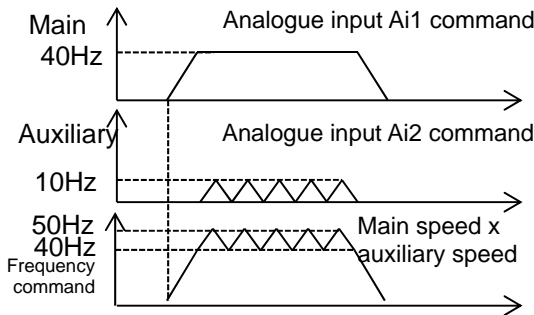

■ Switching of two commands

[AA101]=01 (Ai1 command)/[AA102]=07 (set [Ab110])/ [AA105]=00 (disabled)/[Ab110]=3.00(Hz)

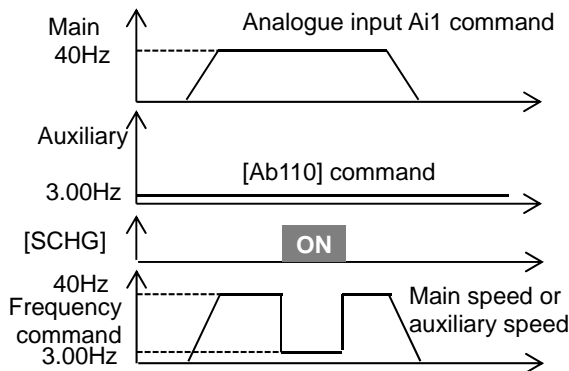

(Ex. 3) Forward rotation at a high speed and reverse rotation at a low speed are made by a command.

[AA101]=01 (Ai1 command)/[AA102]=07 (set [Ab110])/ [AA105]=02 (disabled)/[Ab110]=10.00(Hz)

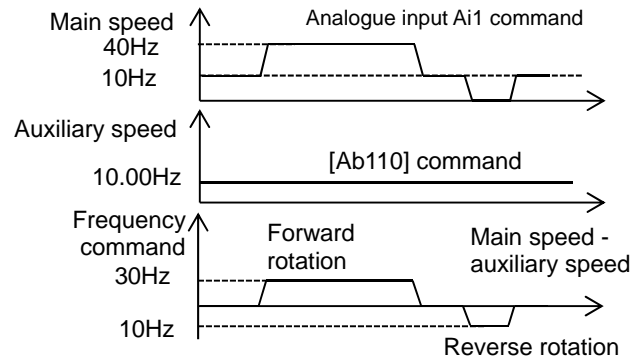

- The same setting can be used for both [AA101] and [AA102], Square can be calculated multiplication.
- The input terminal [FUP]/[FDN] functions are effective for commands where the main speed can be set (with the operator keypad setting, multi-speed setting, and analogue holding function [AHD]).



- The output frequency of the inverter accelerates/decelerates toward the frequency command, following the setting of the acceleration/deceleration time.

**12.4.10** Multi-step switching of frequency commands.



- Want to use signal input to make multi-step switching of the output frequency of the inverter.



- A frequency command is controlled with a signal pattern by setting multiple command frequencies in advance.
- In the multi-step speed command, one can either give a binary combination of 0 (OFF) and 1 (ON) or give a priority on certain terminals (bit operation).
- In the binary operation, a frequency at max. 16th speed with four terminals can be set. In the bit operation, a frequency at max. 8th speed with seven terminals can be set.



- If the operator keypad [AA101]=07 is chosen in the frequency command selection, rewriting of the main speed command [FA-01] automatically rewrites [Ab110], frequency setting of the 0th speed.
- The frequency setting for the 1st to 15th speeds should be made in the 1st-15th speeds of the multi-step speed function ([Ab-11]-[Ab-25]).
- With the multi-step speed function, one can set the acceleration/deceleration time individually for the frequency switching in the multi-step speed command. For details, see “12.8.3 Setting acceleration/deceleration time in multi-step speed”
- The multi-step speed function is effective only for the main speed command. Not applied to the auxiliary speed command
- If [SET] terminal is made ON and the secondary setting function is used, [Ab210] instead of [Ab110] becomes effective.

■ Parameters

Item	Parameters	Data	Description
Main speed command monitor	[FA-01]	Data change depending on the frequency command selection.	The frequency command value is shown.
Multi-step speed selection	[Ab-03]	00	Binary operation, max. 16 speed modes
		01	Bit operation, max. 8 speed modes
0th speed of the multi-step speed	[Ab110]	0.00/Min. frequency -max. frequency (Hz)	0th speed of the multi-step speed
1st-15th speeds of the multi-step speed	[Ab-11]~[Ab-25]	0.00/Min. frequency -max. frequency (Hz)	1st-15th speeds of the multi-step speed
Multi-step input determination time	[CA-55]	0~2000(ms)	This is the time to fix the frequency in switching the multi-step speed.

■ (1) Binary operation (max. 16-speed command: [Ab-03]=00)

**A**

- Multi-step speeds of 0th to 15th speeds can be chosen by assigning 003-006 ([CF1]-[CF4]) to the input terminals 1-9, A, and B [CA-01]-[CA-11].

■ Action table

Multi-step speed	CF4	CF3	CF2	CF1	Parameters
0th speed	OFF	OFF	OFF	OFF	Ab110
1st speed	OFF	OFF	OFF	ON	Ab-11
2nd speed	OFF	OFF	ON	OFF	Ab-12
3rd speed	OFF	OFF	ON	ON	Ab-13
4th speed	OFF	ON	OFF	OFF	Ab-14
5th speed	OFF	ON	OFF	ON	Ab-15
6th speed	OFF	ON	ON	OFF	Ab-16
7th speed	OFF	ON	ON	ON	Ab-17
8th speed	ON	OFF	OFF	OFF	Ab-18
9th speed	ON	OFF	OFF	ON	Ab-19
10th speed	ON	OFF	ON	OFF	Ab-20
11th speed	ON	OFF	ON	ON	Ab-21
12th speed	ON	ON	OFF	OFF	Ab-22
13th speed	ON	ON	OFF	ON	Ab-23
14th speed	ON	ON	ON	OFF	Ab-24
15th speed	ON	ON	ON	ON	Ab-25

■ Action chart

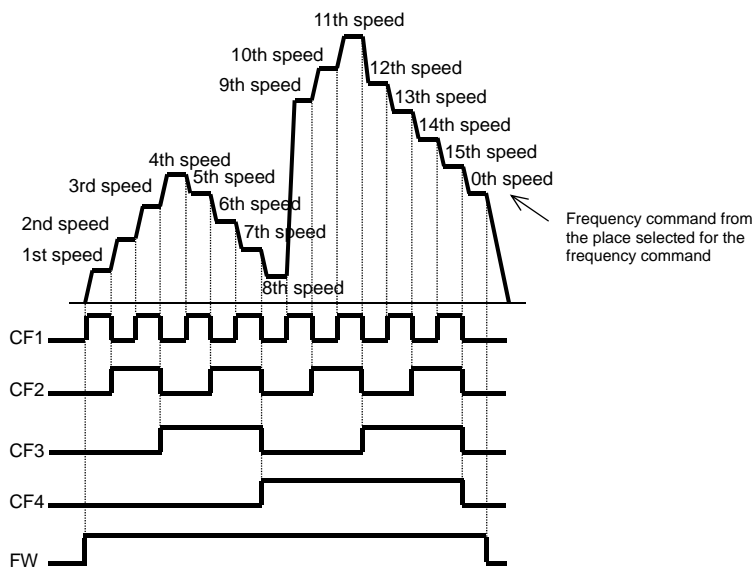

- For the binary operation, idling time to wait for a terminal input to be given can be set in the multi-step input determination time [CA-55]. This can prevent transition during terminal switching.
- Data are fixed after the time specified in [CA-55] passes with no change in the input. Input response would be slow if the determination time is set to be large.
- For the command frequency of the 0th speed, the command designated in the main speed selection [AA101] is used. The left table is for [AA101]=07.

Ex.) 2nd speed is effective.

In this case we have [CA-06]=003 (CF1) and [CA-07]=004 (CF2).

No assignment is made for 005 (CF3) and 006 (CF4).

Only the input terminal No. 7 (CF2) is ON.

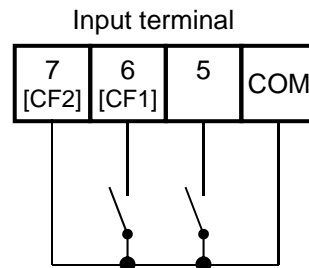

Multi-step speed	CF4	CF3	CF2	CF1
1st speed	OFF	OFF	OFF	ON
2nd speed	OFF	OFF	ON	OFF
3rd speed	OFF	OFF	ON	ON

■ (2) Bit operation (max. 8-speed command: [Ab-03]=01)

**A**

- Multi-step speeds of 0th to 7th speeds can be chosen by assigning 007-013 ([SF1]-[SF7]) to the input terminals 1-9, A, and B [CA-01]-[CA-11].
- The frequency setting of [SF1]-[SF7] should be made to the multi-step speeds of 1st to 7th speeds ([Ab-11]-[Ab-17]).



- If multiple terminals are made ON simultaneously, the one with smaller number has priority. "-" in the table indicates that a frequency is chosen independently from ON/OFF state of the terminals.
- For the command frequency of the 0th speed, the command designated in the main speed selection [AA101] is used. The following table is for [AA101]=07.

■ Action table

Multi-step speed	SF7	SF6	SF5	SF4	SF3	SF2	SF1	Parameters
0th speed	OFF	OFF	OFF	OFF	OFF	OFF	OFF	Ab110
1st speed	-	-	-	-	-	-	ON	Ab-11
2nd speed	-	-	-	-	-	ON	OFF	Ab-12
3rd speed	-	-	-	-	ON	OFF	OFF	Ab-13
4th speed	-	-	-	ON	OFF	OFF	OFF	Ab-14
5th speed	-	-	ON	OFF	OFF	OFF	OFF	Ab-15
6th speed	-	ON	OFF	OFF	OFF	OFF	OFF	Ab-16
7th speed	ON	OFF	OFF	OFF	OFF	OFF	OFF	Ab-17

■ Action chart

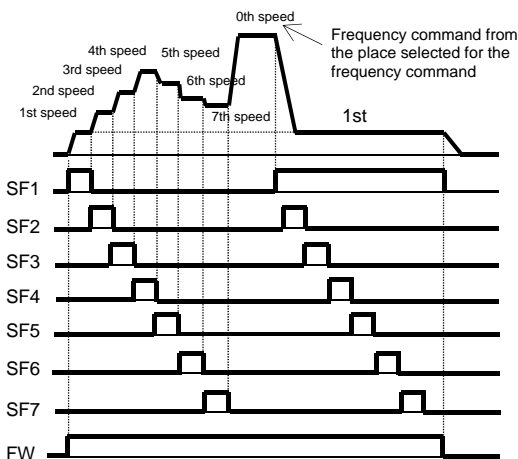

Ex.) 2nd speed is effective.

In this case we have [CA-06]=007 (SF1) and [CA-07]=008 (SF2).

No assignment is made for 009 (SF3) and 013 (SF7).

Only the input terminal No. 7 (SF2) is ON.

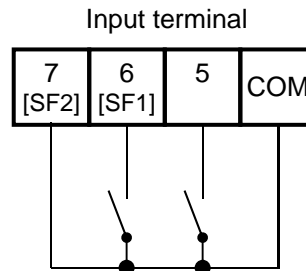

Multi-step speed	SF4	SF3	SF2	SF1
1st speed	-	-	-	ON
2nd speed	-	-	ON	OFF
3rd speed	-	ON	OFF	OFF

If SF1 becomes ON in this state, the 1st speed becomes effective.

**12.4.11** Temporal addition of frequency command



- Want to increase the frequency of the motor only if a signal input is given.
- Want to increase the frequency by giving a signal to the inverter with a conveyor or others.
- Want to remove clogging of the pump by increasing the frequency.



- Only when the input terminal function 014 [ADD] signal is given, the designated frequency is added or subtracted.
- Addition or subtraction is chosen on the basis of the designated sign of the frequency.



- The frequency addition of the input terminal function 014 [ADD] is made within the limited frequency range. If the frequency is not within the range between the upper and lower limits or exceeds the maximum frequency, the frequency command is restricted.
- If the sign of the frequency command changes ((-) to (+) or (+) to (-)) as a result of the arithmetic, the rotation direction is reversed.
- This function is also effective for PID target value.

■ Parameters

Item	Parameters	Data	Description
Additional frequency setting	[AA106]	-590.00~590.00(Hz)	Sets the frequency to add.
Input terminal selection	[CA-01]~[CA-11]	014	[ADD] The designated frequency is added.



12.4.12 Remote operation of frequency



- Want to change the frequency of the motor using signal input.
- Want to change the frequency fusing a remote external button.
- Want to change the PID target value fusing a remote external button.

■ UP/DOWN function



- The frequency command of the inverter can be changed by a signal input if 020 [FUP terminal and 021 [FDN] terminal are assigned in the input terminal function.
- This function works following the selected frequency command when the frequency command selection [AA101] is 07 (parameter effective) or when a multi-step speed command is given.
- The command operation time with the terminals 020[FUP]/021[FDN] being ON follows the acceleration time [CA-64] to increase or the deceleration time [CA-66] to decrease.



- When 020 [FUP] terminal / 021 [FDN] terminal is made ON/OFF immediately after the power shutdown, data may not be able to be correctly saved.
- Cannot be used to set the frequency of the input terminal function 029 [JG] jogging operation.

- Even when 024 [SET] function is used to switch to the second control, the operation time follows the acceleration time [CA-64] to increase or the deceleration time [CA-66] to decrease.
- If 01 (save) is chosen in [CA-61], the frequency value adjusted by the 020 [FUP] terminal / 021 [FDN] function can be saved. To clear the saved frequency value, assign 022[UDC] to the input terminal and change the [UDC] terminal from ON to OFF. Clearance by [UDC] follows the designated value of [CA-62].

■ Action chart

(For the case where the frequency command comes with the parameter setting and multi-step speed function)

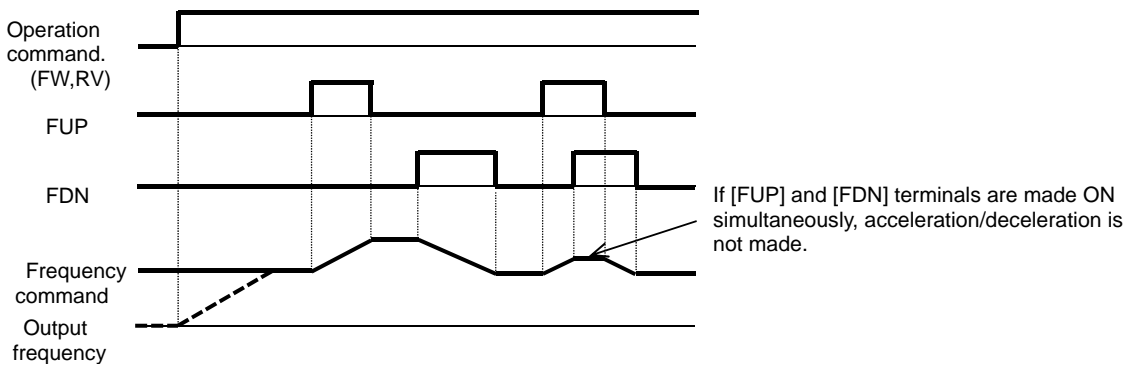

■ Analogue command holding function (analogue holding function)



- If the main speed command [AA101] is an analogue input command (01-03), this function is effective even when data are held by the analogue command holding [AHD] function.
- If 019[AHD] function is effective, the held data can be moved up/down by using [FUP]/[FDN] function.



- The input terminal function 019 [AHD] analogue command holding function (analogue holding function) holds the command of the analogue input when the function becomes ON. When the function becomes OFF, the command returns to the analogue command. Namely, data changes with the [FUP]/[FDN] function are not saved.

■ Action chart

(A frequency command uses [AHD] in the analogue input.)

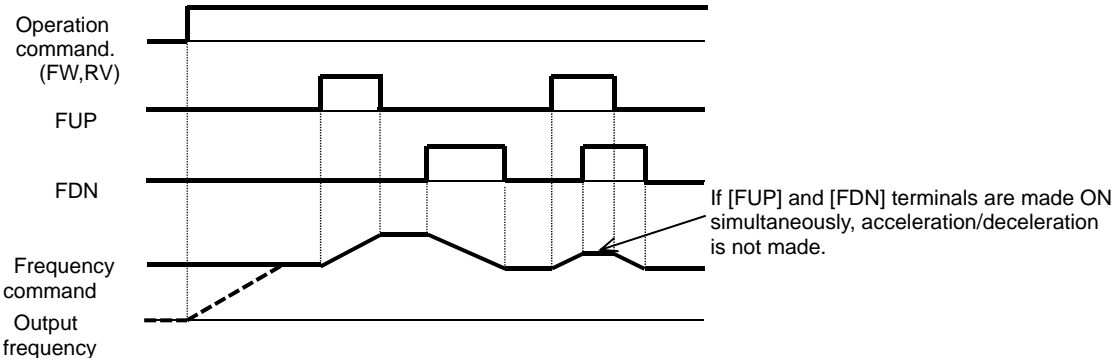

■ Parameters

Item	Parameters	Data	Description
Main speed command selection	[AA101]	01~15	01: Ai1-L input, 02: Ai2-L input, 03: Ai3-L input, 07: parameter setting, 08: RS485 communication, 12: pulse string input (main body), 14: program function EzSQ, 15: PID arithmetic
Input terminal function selection	[CA-01]~[CA-11]	019	AHD: Analogue command holding
		020	FUP: Remote operation acceleration
		021	FDN: Remote operation deceleration
		022	UDC: Remote operation data clearance
FUP/FDN overwriting target selection	[CA-60]	00	Overwrites the frequency command.
		01	PID target value is overwritten.
FUP/FDN memory selection	[CA-61]	00	The command is not saved in case of power shutdown.
		01	The command is saved in case of power shutdown.
FUP/FDN UDC terminal mode selection	[CA-62]	00	Cleared to 0 Hz.
		01	Cleared to the saved command.
Acceleration time for FUP/FDN functions	[CA-64]	0.00~3600.00(s)	Sets acceleration time for FUP/FDN functions.
Deceleration time for FUP/FDN functions	[CA-66]	0.00~3600.00(s)	Sets deceleration time for FUP/FDN functions.

**12.4.13** Temporary change of frequency command destination



- Want to set a frequency temporarily from the analogue command.
- Want to make temporary operation with fixed frequency.



-When 023 [F-OP] terminal is ON, the command destination of [CA-70] is employed in a priority to the frequency command destination given in [AA101].



- When 023 [F-OP] terminal is ON, the operation command destination also employs the operation command selection designated in [CA-71].

■ Parameters

Item	Parameters	Data	Description
Input terminal function selection	[CA-01]~[CA-11]	023	[F-OP]: Gives a forced command.
Frequency command selection with [F-OP] enabled.	[CA-70]	01~15	01: Ai1-L input, 02: Ai2-L input, 03: Ai3-L input, 04: Ai4-L input, 05: Ai5-L input, 06: Ai6-L input, 07: parameter setting, 08: RS485 communication, 09:option 1, 10: option 2, 11: option 3, 12: pulse string input (main body), 13: pulse string input (option) 14: program function EzSQ, 15: PID arithmetic
Operation command selection with [F-OP] enabled.	[CA-71]	00~03	00: [FW]/[RV] terminal, 01: 3 wire, 02: RUN key on operator keypad, 03: RS485 communication, 04: option 1, 05: option 2, 06: option 3

## 12.5 Selecting operation command

### 12.5.1 Types of operation commands

**A**

- The operation command (operation modes) selected in a function is enabled.
- For details, see the description in the next and subsequent sections.



- The operation of the inverter requires not only an operation command but also a frequency command.

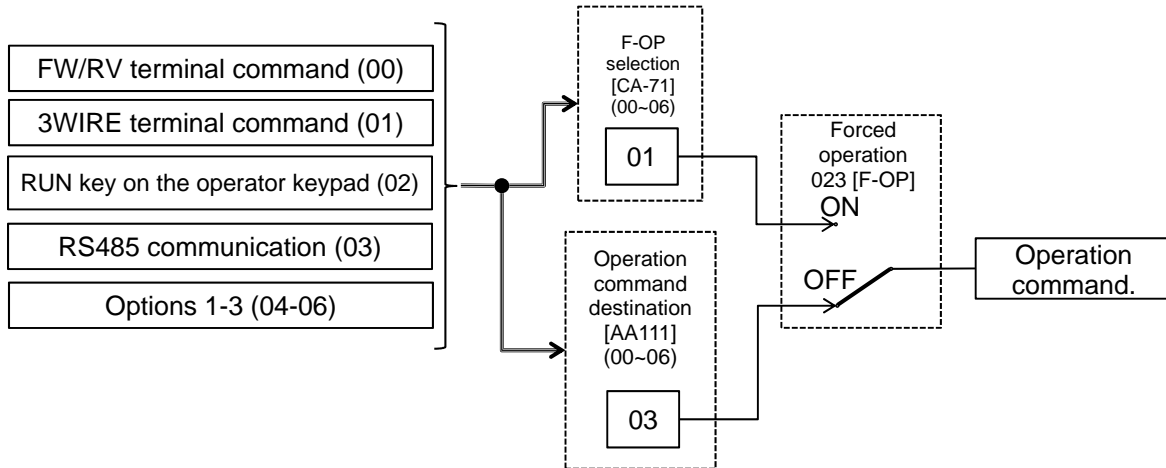

- The above shows an example of operation with [AA111]=02 (RUN key on the operator keypad).

- Functions not assigned to the input terminal functions [CA-01]-[CA-11] become OFF.

### 12.5.2 Operation on operator keypad



- Want to make trial operation from the operator keypad.
- Want to make operation from the operator keypad.



- The operator keypad is used to give a frequency command.
- Use “Operation key” and “Stop key” to make and stop operation, respectively.
- For operation using the operator keypad, the operation direction can be changed by setting RUN key direction selection [AA-12].



- The output of the inverter requires not only an operation command but also a frequency command.
- If the forced operation 023 [F-OP] of the terminal function is enabled, the command destination specified in the [F-OP] function becomes effective irrespective of the present setting.

#### Parameters

Item	Parameters	Data	Description
Operation command selection	[AA111]	02	Operation command from “Operation key”/“Stop key” on the operator keypad.
RUN key direction selection	[AA-12]	00	Forward rotation command from the operator keypad.
		01	Reverse rotation command from the operator keypad.
Output terminal function	[CC-01]~ [CC-07]	011	[REF] ON when an operation command can be given from the operator keypad.

**12.5.3** Operation with forward/reverse rotation terminal



- Want to make operation with input to the terminal of the inverter.
- Want to switch forward and reverse rotation by making the terminal ON/OFF.



- A forward rotation command can be given from [FW] terminal and a reverse one from [RV] terminal.
- Operation can be started/stopped by making the [FW] or [RV] terminal function ON/OFF on the control circuit terminal block of the inverter.
- In the factory setting, the [FW] and [RV] terminals are assigned to the terminal Nos. 9 and 8, respectively. This assignment can be changed by setting [CA-01]-[CA-11] in the input terminal setting selection.
- a/b contact of each terminal can be switched by changing the corresponding setting item of [CA-21]-[CA-31].

■ Parameters

Item	Parameters	Data	Description
Operation command selection	[AA111]	00	Run/Stop from the control circuit terminal block. ([FW], [RV] terminals)
Input terminal function selection	[CA-01]~[CA-11]	01	[FW] terminal function
		02	[RV] terminal function
Input terminal a/b (NO/NC) selection	[CA-21]~[CA-31]	00	a contact (NO)
		01	b contact (NC)



- The output of the inverter requires not only an operation command but also a frequency command.
- The input terminal function 023 [F-OP] is enabled, the command destination specified in the [F-OP] function becomes effective irrespective of the present setting.

- Simultaneous input of a forward and reverse rotation commands is equivalent to stop command.
- The relation between [FW] and [RV] terminals is given below.

FW terminal	RV terminal	Operation command.
OFF	OFF	Stop command
ON	OFF	Forward rotation command.
OFF	ON	Reverse rotation command.
ON	ON	Stop command

- Commands can be given by [FW]/[RV] command of the EzSQ function.

**12.5.4** Operation with 3 wire function of terminal block

**Q**

- Want to make operation with input to the terminal of the inverter.
- Want to make operation with button switch.
- Want to skip the self-holding circuit of the operation button.

**A**

- Operation start command can be given from [STA] terminal and stop command from [STP] terminal.
- To use the 3 wire function, the setting of the operation command selection [AA111] and the input terminal setting selection [CA-01]-[CA-11] needs to be changed.
- Select [AA111]=02 3 wire function. In this example, the 3 wire function is assigned to the input terminal function in the following way.  
\*) Set the terminals as the terminal No. 7 [CA-07]=016, No. 8 [CA-08]=017, No. 9 [CA-09]=018.

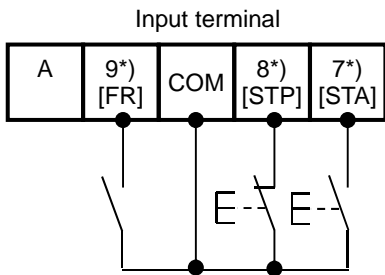

- The output of the inverter requires not only an operation command but also a frequency command.
- The terminal 023 [F-OP] is enabled, the command destination specified in the [F-OP] function becomes effective irrespective of the present setting.

- Operation can be started/stopped by making the 016 [STA]/017 [STP] terminal function ON/OFF on the control circuit terminal block of the inverter.
- 018 [F/R] terminal function switches forward and reverse rotations by the contact.
- The terminal action is made in the following way.

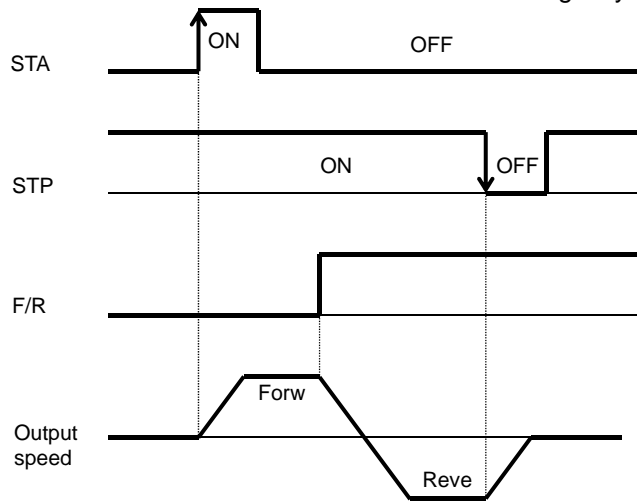

■ Parameters

Item	Parameters	Data	Description
Operation command selection	[AA111]	01	Run/Stop from the control circuit terminal block. ([STA], [STP] terminals)
Input terminal function selection	[CA-01]~[CA-11]	016	[STA] terminal function
		017	[STP] terminal function
		018	[F/R] terminal function

**12.5.5** Operation with RS485 communication



- Want to make operation with a command through RS485 communication.



- RS485 coil is used to give an operation start/stop command.



- The output of the inverter requires not only an operation command but also a frequency command.
- The terminal 023 [F-OP] is enabled, the command destination specified in the [F-OP] function becomes effective irrespective of the present setting.

■ Parameters

Item	Parameters	Data	Description
Operation command selection	[AA111]	03	Start/Stop by RS485 communication command.

**12.5.6** Operation from optional board



- Want to make operation with a command through communication of the optional board.



- Optional communication command is used to give an operation start/stop command.



- The output of the inverter requires not only an operation command but also a frequency command.
- The terminal 023 [F-OP] is enabled, the command destination specified in the [F-OP] function becomes effective irrespective of the present setting.

■ Parameters

Item	Parameters	Data	Description
Operation command selection	[AA111]	04	Frequency command from option 1 enabled.
		05	Frequency command from option 2 enabled.
		06	Frequency command from option 3 enabled.



**12.5.7** Disabling the keys on operator keypad



- Don't want to let the operator keypad stop operation when the operation is made under an external command.
- Don't want to let the operation made by a communication command be stopped but want to reset it in case of a trip.



- When a terminal command or communication command is given, the operation cannot be stopped from the operator keypad by setting [AA-13]=01.
- Set [AA-13]=02 to disable the Stop key and use the resetting function in case of a trip.



- Set [AA-13] to 00: Disabled if a stop command is given from the operator keypad of the inverter in case of emergency.
- Usually, operation under an operation command from other than the operator keypad can be stopped by using the Stop/Reset key on the operator keypad.
- When the operation under an external command is stopped from the operator keypad, the operation stops for safety. To restart the operation, turn off the external command and on it again.
- When 102 [DISP] terminal function is ON, the operator keypad screen is fixed to home screen.

■ Parameters

Item	Parameters	Data	Description
Operation command selection	[AA111]	00	Run/Stop from the control circuit terminal block. ([FW], [RV] terminals)
		01	Run/Stop from the control circuit terminal block. ([STA], [STP] terminals)
		02	Start/Stop by RS485 communication command.
STOP key selection	[AA-13]	00	Function disabled Always recognizes stop/reset key operation.
		01	Function enabled The stop/reset key no longer works.
		02	Only inverter trips can be reset by the stop/reset key.
Input terminal function selection	[CA-01]~ [CA-11]	102	[DISP] terminal function



- [AA-13] STOP key selection is enabled when the operation command [AA111] is set to a value other than the value of the operator keypad (02).
- Unlike SJ700, the communication function on SJ-P1 continues communication even during resetting and therefore no idling time is necessary for the resetting.

### 12.5.8 Temporary change of operation command destination



- Want to make operation from the operator keypad temporarily.
- Want to make operation from the terminal block input temporarily.



- When 023 [F-OP] terminal is ON, the command destination of [CA-71] is employed in a priority to the operation command destination given in [AA111].



- When 023 [F-OP] terminal is ON, the frequency command destination also employs the frequency command selection designated in [CA-70].
- If [AA111] and [CA-71] are set differently from each other, the operation is interrupted when the [F-OP] terminal is made ON or OFF. The selected operation command is enabled when it is made OFF and then ON.

#### Parameters

Item	Parameters	Data	Description
Input terminal function selection	[CA-01]~[CA-11]	023	[F-OP]: Gives a forced command.
Frequency command selection with [F-OP] enabled.	[CA-70]	01~15	01: Ai1-L input, 02: Ai2-L input, 03: Ai3-L input, 04: Ai4-L input, 05: Ai5-L input, 06: Ai6-L input, 07: parameter setting, 08: RS485 communication, 09: option 1, 10: option 2, 11: option 3, 12: pulse string input (main body), 13: pulse string input (optional) 14: program function EzSQ, 15: PID arithmetic
Operation command selection with [F-OP] enabled.	[CA-71]	00~06	00: [FW]/[RV] terminal, 01: 3 wire, 02: RUN key on operator keypad, 03: RS485 communication, 04: option 1, 05: option 2, 06: option 3



12.6 Limit frequency and operation commands.

12.6.1 Limit frequency and operation commands.



- Want to limit the command range.
- Want to set the lower limit of the frequency command value to prevent excessively low flow rate.
- Want to set the upper limit of the frequency command value for the system.



- A limiter of the upper and lower limits of the frequency command can be set. The upper limiter can be set from analogue input by setting [bA101].
- This function limits a frequency command even if a frequency command value outside the range between the upper and lower limiters is set.
- When [bA102] is 0.00 Hz and [bA103] is 0.00 Hz, the corresponding data do not work.



- The upper and lower limiters should be set lower than the max. frequency. Otherwise, warning of the inconsistency will arise.
- To set the limiters, set the upper limiter [bA102] first. Make sure that it is larger than the lower limiter value [bA103].
- Under the restriction by the upper and lower limiters and the minimum frequency, a LIM icon appears.
- To enable the upper limiter, set [bA101]. When [bA101]=07, the upper limiter is enabled by setting [bA102] to a value other than 0.00.

Parameters

Item	Parameters	Data	Description
Max. frequency	For IM [Hb105] For SM (PMM) [Hd105]	10.00~590.00(Hz)	Sets the max. frequency. IM: Induction motor [AA121]=00-10 SM(PMM): Synchronous motor (permanent magnet motor) [AA121]=11, 12
Min. frequency	[Hb130]	0.00~10.00(Hz)	Sets the min. frequency to start output. Disabled when [AA121]=09, 10.
Selection of upper limit of frequency	[bA101]	00~13	00 (disabling)/01 (Ai1 terminal input)/02 (Ai2 terminal input)/ 03 (Ai3 terminal input)/04 (Ai4 terminal input)/ 05 (Ai5 terminal input)/06 (Ai6 terminal input)/ 07 (parameter setting)/08 (RS485)/09 (option 1)/ 10 (option 2)/11 (option 3)/ 12 (pulse string input (main body))/13 (pulse string input P1-FB)
Frequency upper limiter	[bA102]	0.00, lower limiter of frequency -max. frequency (Hz)	Sets the upper limit of the frequency command. Disabled when 0.00 is set (for [bA101]=07).
Frequency lower limiter	[bA103]	0.00, start frequency -upper limiter of frequency (Hz)	Sets the lower limit of the frequency command. Disabled when 0.00 is set.
Frequency upper limit monitor	[dA-14]	0.00~590.00(Hz)	The employed upper limit of the frequency is shown.

Limiting a command

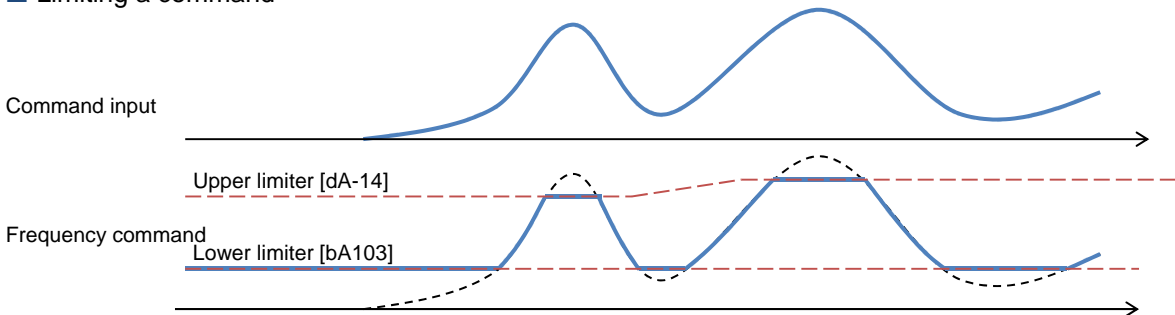

### 12.6.2 Limit operation command direction.



- Want to limit the operation command direction.
- Want to prevent damage of the machine due to the inverter output in opposite direction.



- Output in the allowed rotation direction can be obtained by setting the operation direction limit selection [AA114] to limit the direction of the operation.
- Set the operation direction limit selection if reverse operation output could adversely affect connected machines with no external force applied.



- Even if this function works, you may have output of reverse operation as a result of the control other than V/f control. In this case, enable the reverse operation prevention function. See “12.6.3 Limiting output direction.”
- Even if this function is used, the motor may rotate in the reverse direction under an external force applied in that direction. If you use this function to limit the operation direction, use the function for a system that does not receive an external force applied in the reverse direction.
- The reverse rotation direction command due to a negative value of the frequency is also restricted.
- Output stops when the direction is being limited.

#### Parameters

Item	Parameters	Data	Description
Operation direction limit selection	[AA114]	00	Both forward and reverse rotations enabled
		01	Only forward rotation enabled
		02	Only reverse rotation enabled

### 12.6.3 Limit output direction.



- Want to prevent damage of the machine due to reverse rotation of the motor.



- Under some control, output at a low speed in the direction opposite to the one specified in the operation command may occur. The output can be restricted in the direction specified in the operation command if the reverse rotation prevention function selection [HC114] is used.
- Enable the reverse rotation prevention function selection if the reverse rotation of the motor could give damage to the connected machine.



- This function is enabled when the control method [AA121] is set to 08 (sensorless vector control), 09 (sensorless vector control in zero speed range), or 10 (vector control with sensor).
- Even if this function is used, the motor may rotate in the reverse direction under a high-load external force applied in that direction. If you use this function to limit the operation direction, make sure that the motor would not make reverse rotation.

Item	Parameters	Data	Description
Control method selection	[AA121]	08	Sensorless vector control
		09	Sensorless vector control in zero speed range
		10	Vector control with sensor
Selection of reverse rotation prevention function	[HC114]	00	Disabled
		01	Enabled

**12.6.4** No output until operation permission



- Want to have no motor output until the system permits the operation.



- The system is configured in such a way that the operation can be stopped for safety irrespective of the operation command until the system allows the operation.
- If 101[REN] is assigned in the input terminal function, the inverter is not allowed to make output until the terminal [REN] becomes ON.



- This function becomes enabled when 101[REN] is set to any of the input terminal selections [CA-01]-[CA-11].
- The operation does not start if [REN] is set to OFF. To make output from the inverter based on an operation command in a trial operation, [REN] needs to be set to 000[no] temporarily.

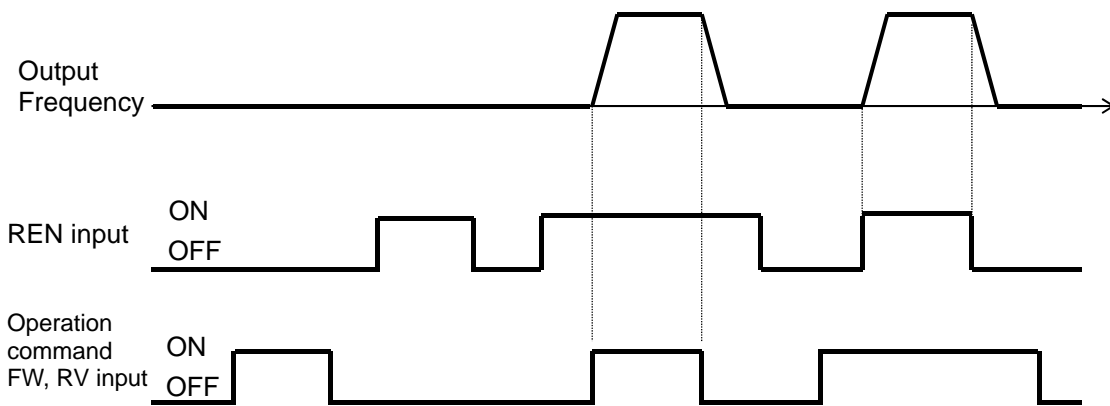

■ Parameters

Item	Parameters	Data	Description
Input terminal function	[CA-01]~[CA-11]	101	[REN]: Controls Permitted/Not permitted using operation permission signal. ON: Allowed OFF: Not allowed

## 12.7 Temperature protection of motor

### 12.7.1 Electronic thermal setting of motor



- Want to make thermal protection of motor
- Want to change the protection level in accordance with the motor rated voltage.

■ Change of electronic thermal level of motor



- Setting in accordance with the motor rated current protects continuous flow of current in the motor. To make the protection earlier, the protection level should be set lower than the motor rated current.



- Make the setting correctly as this is necessary to protect the motor.
- When the thermal protection begins, [E005] motor electronic thermal error occurs.
- Irrespective of the thermal setting of the motor, the inverter electronic thermal protection works independently to protect the inverter.
- When the current grows rapidly, [E001] excessive current error could occur before [E005] motor electronic thermal error.
- Even electronic thermal level is set high, electronic thermal for inverter itself works separately, at frequency decreased from 5Hz and 80% at 0Hz.

(Ex. 1) Motor rated current 64A ([bC110]=64.0A)  
 Setting range:12.8A(20%)~204.0A(300%)  
 When driven at a base frequency

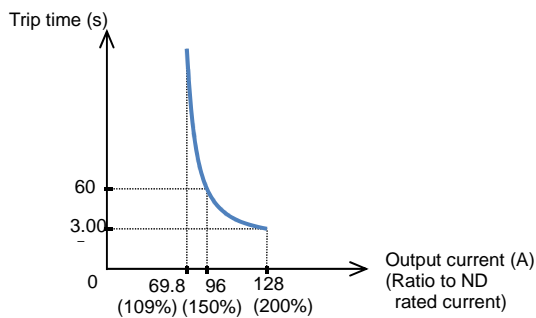

- The electronic thermal time-limited characteristics is shown in (Ex. 1) when the first electronic thermal level [bC110] is 64A
- Example 1 shows the case of reduction ratio x1. (For example, the case of the motor driven at a base frequency for [bC111]=01.)
- The magnification ratio and hence the time to a trip could change depending on the choice of the electronic thermal characteristic.
- A trip occurs in 60 s when an electric current of 150% of the electronic thermal level x1 flows continuously.

■ Parameters

Item	Parameters	Data	Description
First electronic thermal level	[bC110]	In range of 20-300% of the inverter rated current (unit: A) *1)	Sets the protection current of motor.
First electronic thermal characteristics selection	[bC111]	00	Reduced torque characteristics: Pattern for cooling function deterioration at a low speed
		01	Constant torque characteristics: Pattern for constant output
		02	Free setting: Multiple patterns are available according to the motor characteristics.

\*1) The inverter rated current is switched by the load type selection [Ub-03]. Even if [bC110] is set to be high, [E001] excessive current error occurs when the current exceeds the excess current level.



Change of electronic thermal characteristics



- Want to make protection taking account of the cooling function at a low speed.
- Want to change the thermal protection setting pattern freely.



- Optimal protection characteristics can be achieved with the deterioration of the cooling ability of the motor at a low speed taken account of. ([bC111]=00)
- Frequency-dependent characteristics can be set in the selection of the electronic thermal characteristics. ([bC111]=02)



- Autocooling motor needs to be used with reduced load (current) since the cooling function of the autocooling fan becomes less effective when the motor rotation frequency decreases.
- The reduced torque characteristics are in accordance with the heat generation of the autocooling motor.

Parameters

Item	Parameters	Data	Description
First electronic thermal characteristics selection	[bC111]	00	Reduced torque characteristics: Pattern for cooling function deterioration at a low speed
		01	Constant torque characteristics: Pattern for constant output
		02	Free setting: Multiple patterns are available according to the motor characteristics.

Reduced torque electronic thermal [bC111]=00

(Ex. 2) Induction motor rated current 64A, [bC110]=64 A  
 For base frequency [Hb104]=60Hz, output frequency=20 Hz



- Can be used for load reduction in accordance with the cooling performance at a low speed.
- When the first electronic thermal level [bC110] is 64 A, the reduction ratio is  $\times 0.8$  for operations at a base frequency of 60 Hz and output frequency of 20 Hz and the electronic thermal time-limited characteristics are given in the lower part of Example 2.
- Since Example 1 shows the case of the reduction ratio  $\times 1$ , a trip occurs in 60 s when an electric current of 150%  $\times 1$  of the ND rated current flows continuously. However in Example 2, a trip occurs in 60 s when an electric current of  $150\% \times 0.8 = 120\%$  of the ND rated current flows continuously.

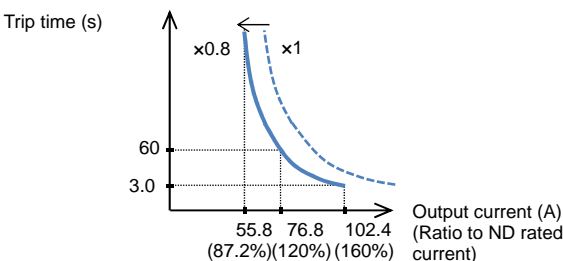
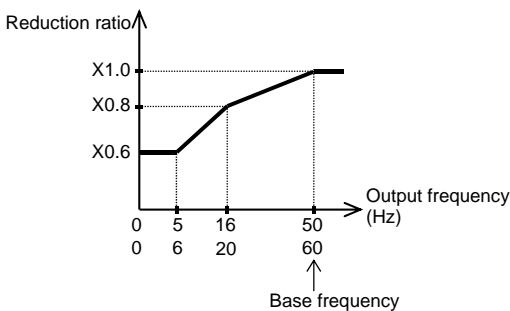

- Constant torque electronic thermal
  - Use this setting to use the constant-torque motor

(Ex. 3) For induction motor rated current: 64A,  
 [bC110]=64(A)  
 Base frequency [Hb104]=50Hz, output frequency  
 =5Hz

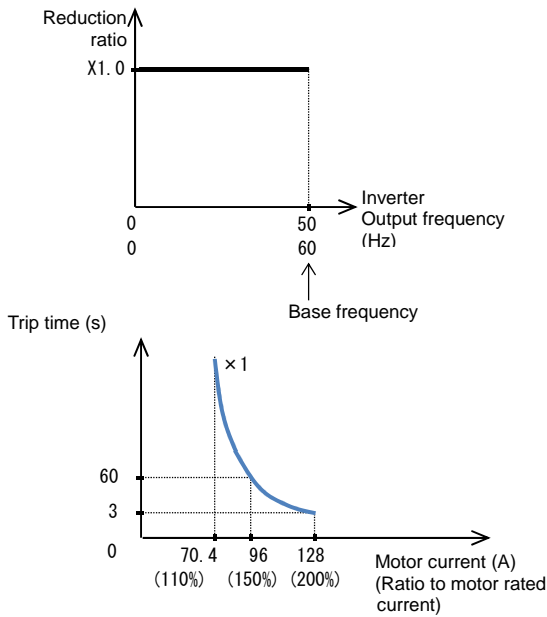

- When the first electronic thermal level [bC110] is 64 A, the reduction ratio is  $\times 0.9$  for operations at a base frequency of 60 Hz and output frequency of 2.5 Hz and the electronic thermal time-limited characteristics are given in the lower part of Example 3.
- Since Example 1 shows the case of the reduction ratio  $\times 1$ , a trip occurs in 60 s when an electric current of 150%  $\times 1$  of the ND rated current flows continuously. However in Example 3, a trip occurs in 60 s when an electric current of  $150\% \times 0.9 = 135\%$  of the ND rated current flows continuously.

- Free electronic thermal characteristics
  - To protect the motor, the electronic thermal characteristics can be freely set in accordance with the load.

■ Parameters

Item	Parameters	Data	Description
Free electronic thermal frequency 1	[bC120]	0.00~[bC122](Hz)	Frequency corresponding to free electronic thermal current 1
Free electronic thermal current 1	[bC121]	Inverter rated current $\times$ 0-300% (A) *1)	Current corresponding to free electronic thermal frequency 1
Free electronic thermal frequency 2	[bC122]	[bC120]~[bC124](Hz)	Frequency corresponding to free electronic thermal current 2
Free electronic thermal current 2	[bC123]	Inverter rated current $\times$ 0-300% (A) *1)	Current corresponding to free electronic thermal frequency 2
Free electronic thermal frequency 3	[bC124]	[bC122]~590.00(Hz)	Frequency corresponding to free electronic thermal current 3
Free electronic thermal current 3	[bC125]	Inverter rated current $\times$ 0-300% (A) *1)	Current corresponding to free electronic thermal frequency 3

\*1) The inverter rated current is switched by the load type selection [Ub-03].

Free electronic thermal characteristics (continued)  
(Ex. 4) For output frequency of [bC122]

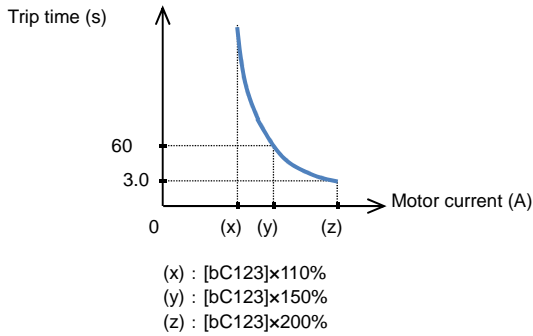
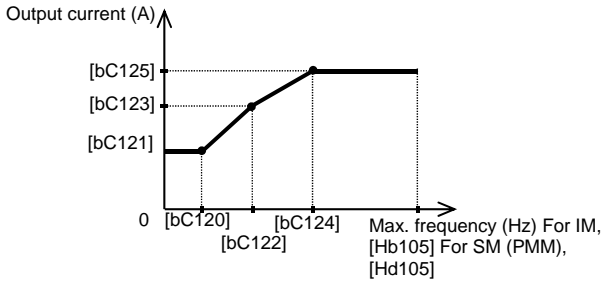

Change of heat emission characteristics of electronic thermal



- Want to set heat emission characteristics of the motor.



- When the current is below the electronic thermal level, the temperature integration data can be reduced according to the heat emission from the motor. ([bC112]=01)
- Constant period mode employed in SJ700 can also be chosen.

Ex. 1) Subtraction mode (for [bC112]=01, [bC113]=600 s(10 min.))

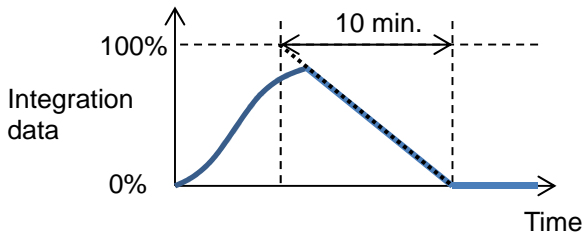

- When the output frequency coincides with the first free-electronic thermal frequency 2 [bC122], the electronic thermal time-limited characteristics are given in the lower part of Example 4.
- In Example 4, a trip occurs in 60 s when an electric current of 150% of the designated first free-electronic thermal current 2 [bC123] flows continuously.



- When [bC121][bC123][bC125] are set as default (0.00) and [bC111] electronic thermal is set as 02, E005 is generated.
- Be sure to set [bC125][bC123] and [bC121] in this sequence when to set free electronic thermal.



- The electronic thermal of the inverter works independently even when the electronic thermal subtraction time is made shorter.
- Appropriate setting should be made for the motor that you use.
- In case of [bC112]=00, resetting cannot be made in 10 s after occurrence of an error.
- [bC112]=00 to be set to be equivalent to SJ700.

Ex. 2) Constant period mode (for [bC112]=00)

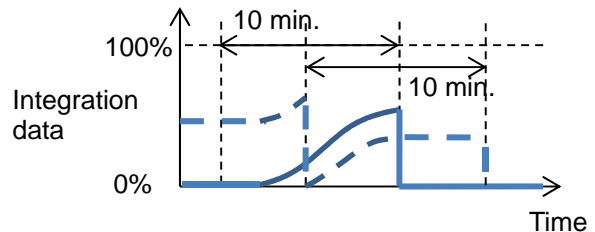

\*) In the constant period mode, a trip occurs when either of the duplicated counters reaches 100%. In the constant period mode, data are cleared with a constant period of 10 minutes.

Parameters

Item	Parameters	Data	Description
First electronic thermal subtraction function selection	[bC112]	00	Constant period mode: The temperature integration data are cleared with a constant period of 10 minutes.
		01	Subtraction mode: The temperature integration data are subtracted in accordance with the heat emission of the motor.
First electronic thermal subtraction time	[bC113]	1s~1000s	Should be set in accordance with the heat emission time of the motor. Sets the time for the integration data to change from 100% to 0%.

■ Maintaining electronic thermal after power termination or resetting



- Want to continue the motor protection even after the power is shut off and the system is restarted.



- The temperature integration data of the motor are saved even after power termination or inverter trip resetting. When the motor current increases again when the power is made on or the system is reset, the system is restarted with the saved temperature integration data.



- When the data-holding function is used, the integration data are held even if the inverter is powered off for a long period of time, and a risk of occurrence of an error would increase. After it is powered on, a short-time operation could cause an error.

Item	Parameters	Data	Description
First electronic thermal data holding selection	[bC-14]	00	Not holding: The temperature integration data are cleared by the power shut-off and resetting.
		01	Holding: The temperature integration data are not cleared and subtracted only in the subtraction mode.

■ Related functions



- Want to know the integration state of the motor electronic thermal.



- The integration state can be monitored from [dA-42] electronic thermal load rate monitor (motor).
- If you want a warning signal when the electronic thermal exceeds a certain level, set the output signal function 026 [THM] and [CE-30] electronic thermal warning level (motor). For details, see “12.19.8 Output of warning before thermal protection of motor.”



- Want to know the integration state of the inverter electronic thermal.



- The integration state can be monitored from [dA-43] electronic thermal load rate monitor (controller).
- If you want a warning signal when the electronic thermal exceeds a certain level, set the output signal function 027 [THC] and [CE-31] electronic thermal warning level (controller). For details, see “12.19.9 Output of warning before thermal protection of inverter.”

## 12.7.2 Monitoring of motor temperature



- Want to make thermal protection of motor
- Want to make temperature protection of the motor using a thermistor resistance.



- The temperature protection of an external device can be made by connecting a thermistor installed in the motor or other external device to the inverter and setting the function of the thermistor.
- The external thermistor should be wired between the control terminals TH+ and TH-.
- Set the thermistor selection [Cb-40] and the resistance level to cause an error [bb-70] in accordance with the thermistor's specifications.
- [E035] thermistor error occurs when the thermistor resistance reaches the thermistor error level [bb-70] depending on the motor temperature.
- When [Cb-40] is set to 02, [dA-38] motor temperature monitor indicates the detected temperature of the motor.



- When an external thermistor is not connected, a trip occurs if the thermistor selection [Cb-40] is set to 01.
- To use this function, the wiring distance between the motor and the inverter has to be 20 m or shorter. Since the current flowing in the thermistor is very weak, a measure such as wiring separation should be taken to prevent noise from the motor current.
- When [Cb-40] is set to a value other than 02, [dA-38] motor temperature monitor indicates 0 °C.

### Parameters

Item	Parameters	Data	Description
Thermistor error level	[bb-70]	0~10000.(Ω)	Set the resistance for the temperature at which a trip occurs in accordance with the thermistor resistance specifications. Effective when [Cb-40]=01, 02
Thermistor selection	[Cb-40]	00	Disabled
		01	Enabled Positive temperature coefficient resistor (PTC)
		02	Enabled Negative temperature coefficient resistor (NTC)
Thermistor adjustment	[Cb-41]	0.0~1000.	Use as gain adjustment.
Motor temperature monitor	[dA-38]	-20.0~200.0(C°)	Indicates the detected motor temperature.

## 12.8 Use function of accelerating or decelerating motor speed

### 12.8.1 Change acceleration time and deceleration time

#### Q

- To speed up the acceleration of the motor to make it more responsive.
- To extend the acceleration time for the purpose of preventing over current.
- To extend the deceleration time for the purpose of preventing over voltage.
- To slow down the acceleration or deceleration of the motor that has a large load inertia.

#### A

- Set up the acceleration time and the deceleration time of the motor. Set a longer time for slower acceleration or deceleration; set a shorter time for faster acceleration or deceleration.
- Set, as the acceleration time, the time that it takes to rise from 0 Hz to the maximum frequency; set as the deceleration time, the time that it takes to fall from the maximum frequency to 0 Hz.
- In the initial state, the acceleration time 1 [AC120] and the deceleration time 1 [AC122] are enabled.
- The currently enabled acceleration time and deceleration time can be monitored with [FA-10] and [FA-12], respectively; In the initial state, [FA-10] = [AC120] acceleration time 1 and [FA-12] = [AC122] deceleration time 1



- When the function of acceleration or deceleration action cancellation 071 [LAC] is selected as the Input terminal function and the signal is turned ON, the set acceleration or deceleration time will become re-set at 0 s and the output frequency will be made instantaneously to follow the frequency command.
- The target of command for the acceleration or deceleration time can be selected with [AC-01].
  - Employ the internally-set acceleration or deceleration time.
  - Employ the acceleration or deceleration time of the program function EzSQ.
- The acceleration or deceleration time may be changed in response to the command given by the multi-speed function. For details, see Chap. 12.4.10: Switching the frequency in multiple speeds.

#### ■ Parameter

Item	Parameter	Data	Description
Maximum frequency	For IM, [Hb105] For SM (PMM), [Hd105]	10.00~590.00(Hz)	Set the maximum value for the frequency.
Acceleration time 1	[AC120]	0.00~3600.00(s)	Set, as the acceleration time, the time that it takes to rise from 0 Hz to the maximum frequency.
Deceleration time 1	[AC122]	0.00~3600.00(s)	Set, as the deceleration time, the time that it takes to fall from the maximum frequency to 0 Hz.
Acceleration or deceleration input type	[AC-01]	00~04	00: Parameter set-up 04: Program function EzSQ
Input terminal selection	[CA-01]~[CA-11]	071	Acceleration or deceleration cancellation function [LAC] OFF: Function disabled. ON: Ignore the acceleration or deceleration time, and follow the command.
Acceleration time (Monitor + Setting)	[FA-10]	0.00~3600.00(s)	Display the currently-enabled acceleration time.
Deceleration time (Monitor + Setting)	[FA-12]	0.00~3600.00(s)	Display the currently-enabled deceleration time.

■ An actual example of setting up the acceleration or deceleration time

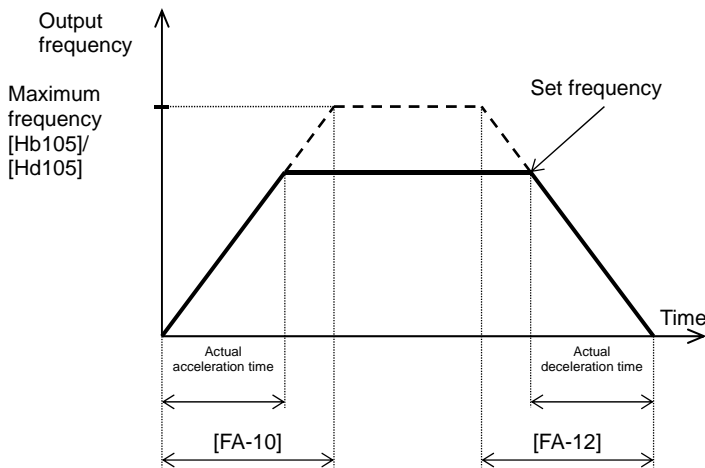

Acceleration time  $t_s$

$$t_s = \frac{(J_L + J_M) \times N_M}{9.55 \times (T_s - T_L)}$$

Deceleration time  $t_B$

$$t_B = \frac{(J_L + J_M) \times N_M}{9.55 \times (T_B + T_L)}$$

$J_L$  : Moment of inertia J (kg·m<sup>2</sup>) of the load converted into that of the motor shaft.

$J_M$  : Moment of inertia J (kg·m<sup>2</sup>) of the motor.

$N_M$  : Revolution speed of the motor (r/min)

$T_s$  : Maximum acceleration torque (N·m) of the motor driven by the inverter.

$T_B$  : Maximum deceleration torque (N·m) of the motor driven by the inverter.

$T_L$  : required operating torque (N·m)



- However short the acceleration or deceleration time is set, the actual acceleration or deceleration of the motor cannot be shorter than the minimum acceleration or deceleration time that is determined by the moment of inertia J of the mechanical system and the motor torque. An act of acceleration or deceleration in a shorter time than the minimum acceleration or deceleration time may cause an over current or over voltage trip to happen.

### 12.8.2 Switch acceleration time and deceleration time in two stages



- To change the acceleration or deceleration time by an external command.
- To slowly accelerate at lower speeds because a larger torque is needed for starting the movement; to shorten the acceleration time at higher speeds than a predetermined value for the purpose of enhancing the response.
- To revolve forward with faster acceleration or deceleration; to revolve backward with slower acceleration or deceleration.



- Setting this function allows you to change the acceleration or deceleration time while driving in response to the terminal command, the frequency command, or the direction command.
- When [AC115] = 00, setting 031 [2CH] in any of the [CA-01] to [CA-11] and turning OFF/ON the target Input terminal allows you to switch the acceleration or deceleration time. ⇒ (Example 1)



- When the input terminal is used for switching, operation should be performed by assigning 031 [2CH] to any of [CA-01] to [CA-11].

- When [AC115] = 01, the frequency command and the relationship between the set values [AC116] and [AC117] can be used to switch the acceleration or deceleration time.  
⇒ (Example 2)
- When [AC115] = 02, the acceleration or deceleration time can be switched between that for the forward revolution and that for the backward revolution.  
⇒ (Example 3)

#### Parameter

Item	Parameter	Data	Description
Maximum frequency	For IM, [Hb105] For SM (PMM), [Hd105]	10.00~590.00(Hz)	Set the maximum value for the frequency.
Acceleration time 1	[AC120]	0.00~3600.00(s)	Set, as the acceleration time, the time that it takes to rise from 0 Hz to the maximum frequency.
Deceleration time 1	[AC122]	0.00~3600.00(s)	Set, as the deceleration time, the time that it takes to fall from the maximum frequency to 0 Hz.
Acceleration time 2	[AC124]	0.00~3600.00(s)	Set, as the acceleration time, the time that it takes to rise from 0 Hz to the maximum frequency.
Deceleration time 2	[AC126]	0.00~3600.00(s)	Set, as the deceleration time, the time that it takes to fall from the maximum frequency to 0 Hz.
2-stage acceleration or deceleration selection	[AC115]	00	Switching by [2CH] terminal (Example 1)
		01	Switching by 2-stage acceleration or deceleration frequency (Example 2)
		02	Enabled only when the revolution is switched between the forward and the backward directions (Example 3)
2-stage acceleration frequency	[AC116]	0.00~590.00(Hz)	Enabled when 2-stage acceleration or deceleration selection [AC115] is 01.
2-stage deceleration frequency	[AC117]	0.00~590.00(Hz)	Enabled when 2-stage acceleration or deceleration selection [AC115] is 01.
Acceleration or deceleration input type	[AC-01]	00	Use the "Setting" of the operator keypad to input the type.
Input terminal function selection	[CA-01]~[CA-11]	031	2-stage acceleration or deceleration function [2CH]. When [AC115] = 00, OFF: The set acceleration or deceleration command is enabled. ON: [AC124]/[AC126] is forcefully enabled.



**A**

- You can use [AC115] to select one of the following three methods of switching the acceleration or deceleration time:
  - Switching by the Input terminal function [2CH];
  - Automatically switching by any given frequency; and
  - Automatically switching only at the time of switching between the forward revolution and the backward revolution.
- Described below is an exemplar case of switching between the acceleration or deceleration time 1 and the acceleration or deceleration time 2.



- Set, as the acceleration time, the time that it takes to rise from 0 Hz to the maximum frequency; and set as the deceleration time, the time that it takes to fall from the maximum frequency to 0 Hz. Each of the set times is the corresponding one of the following values.
  - Acceleration time 1: Calculated value from [AC120];
  - Deceleration time 1: Calculated value from [AC122];
  - Acceleration time 2: Calculated value from [AC124]; and
  - Deceleration time 2: Calculated value from [AC126].

(Example 1) In the case of setting [AC115] = 00

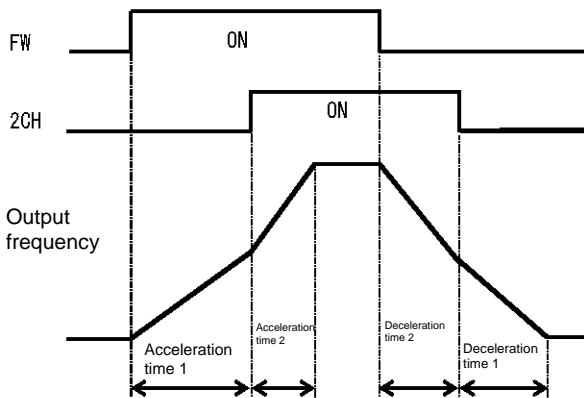

(Example 2) In the case of setting [AC115] = 01

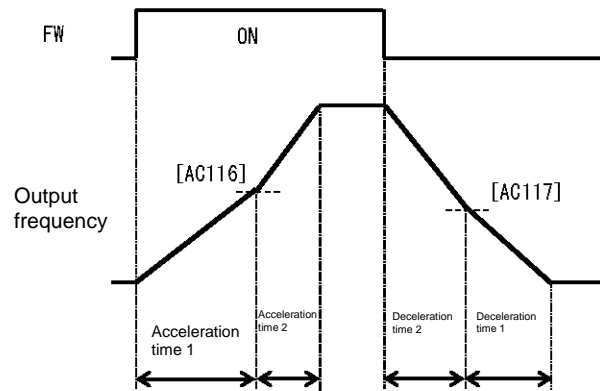

(Example 3) In the case of setting [AC115] = 02

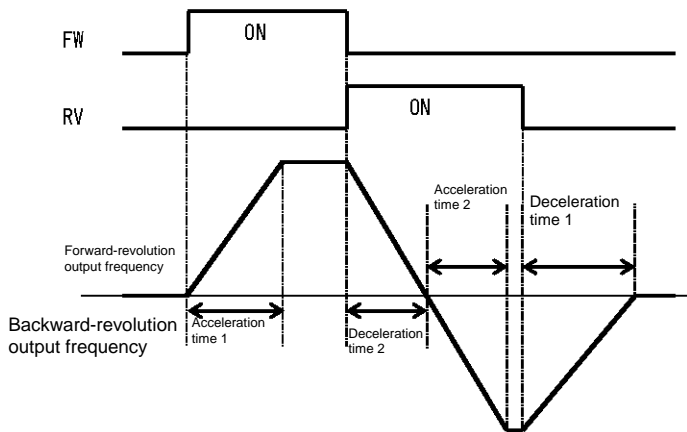

### 12.8.3 Switch the acceleration or deceleration time in multiple stages.



- To use the multi-speed command by giving a frequency command with different acceleration or deceleration times.
- To accelerate or decelerate to a predetermined frequency by using a plurality of different acceleration or deceleration times.



- Setting up this function allows the acceleration or deceleration time to be changed in response to the multi-speed terminal command.

#### Parameter



- When using the input terminal function to switch the multiple speeds, operation should be performed by assigning 003 [CF1] to 006 [CF4] or 007 [SF1] to 013 [SF7] to any of [CA-01] to [CA-11].
- When [AC-02] multi-stage acceleration or deceleration selection is 01, the 2-stage acceleration or deceleration function is disabled.

Item	Parameter	Data	Description
Multi-stage acceleration or deceleration selection	[AC-02]	00	The acceleration or deceleration time follows [AC120]/[AC122] or [AC124]/[AC126] (when 2-stage acceleration or deceleration function is enabled).
		01	The acceleration or deceleration time will be switched in accordance with the multi-speed command.
Multi-speed command	[Ab-11]~[Ab-25]	0.00~590.00 (Hz)	Set the multi-speed command with 1st speed [Ab-11] to 15th speed [Ab-25].
Acceleration time set-up for the multi-speed 1st to 15th speeds	[AC-30], [AC-34], [AC-38], [AC-42], [AC-46], [AC-50], [AC-54], [AC-58], [AC-62], [AC-66], [AC-70], [AC-74], [AC-78], [AC-82], [AC-86]	0.00~3600.00(s)	Set an acceleration time ranging from 0 Hz to the maximum frequency for each of the multi-speed commands.
Deceleration time set-up for the multi-speed 1st to 15th speeds	[AC-32], [AC-36], [AC-40], [AC-44], [AC-48], [AC-52], [AC-56], [AC-60], [AC-64], [AC-68], [AC-72], [AC-76], [AC-80], [AC-84], [AC-88]	0.00~3600.00(s)	Set a deceleration time ranging from the maximum frequency to 0 Hz for each of the multi-speed commands.
Multi-speed selection	[Ab-03]	00	Corresponding to 16-speed binary operation. 003[CF1]~006[CF4]
		01	Corresponding to 8-speed bit operation. 007[SF1]~013[SF7]
Input terminal function selection	[CA-01]~[CA-11]	003~006/ 007~013	Implementing the multi-speed command. 003[CF1]~006[CF4]/ 007[SF1]~013[SF7]

**A**

- Shown below are the multi-speed table for binary operation (when [Ab-03] = 00) and that for bit operation (when [Ab-03] = 01).

■ Table for binary operation [Ab-03]=00.

Input terminal function 003 [CF1] to 006 [CF4]

Multiple speeds	CF4	CF3	CF2	CF1
0th speed	OFF	OFF	OFF	OFF
1st speed	OFF	OFF	OFF	ON
2nd speed	OFF	OFF	ON	OFF
3rd speed	OFF	OFF	ON	ON
4th speed	OFF	ON	OFF	OFF
5th speed	OFF	ON	OFF	ON
6th speed	OFF	ON	ON	OFF
7th speed	OFF	ON	ON	ON
8th speed	ON	OFF	OFF	OFF
9th speed	ON	OFF	OFF	ON
10th speed	ON	OFF	ON	OFF
11th speed	ON	OFF	ON	ON
12th speed	ON	ON	OFF	OFF
13th speed	ON	ON	OFF	ON
14th speed	ON	ON	ON	OFF
15th speed	ON	ON	ON	ON

■ Table for bit operation

[Ab-03] = 01; Input terminal function 007 [SF1] to 013 [SF7]

Multiple speeds	SF7	SF6	SF5	SF4	SF3	SF2	SF1
0th speed	OFF	OFF	OFF	OFF	OFF	OFF	OFF
1st speed	-	-	-	-	-	-	ON
2nd speed	-	-	-	-	-	ON	OFF
3rd speed	-	-	-	-	ON	OFF	OFF
4th speed	-	-	-	ON	OFF	OFF	OFF
5th speed	-	-	ON	OFF	OFF	OFF	OFF
6th speed	-	ON	OFF	OFF	OFF	OFF	OFF
7th speed	ON	OFF	OFF	OFF	OFF	OFF	OFF

■ Exemplar operation

If the set frequency is the same, only the acceleration or deceleration time can be changed.

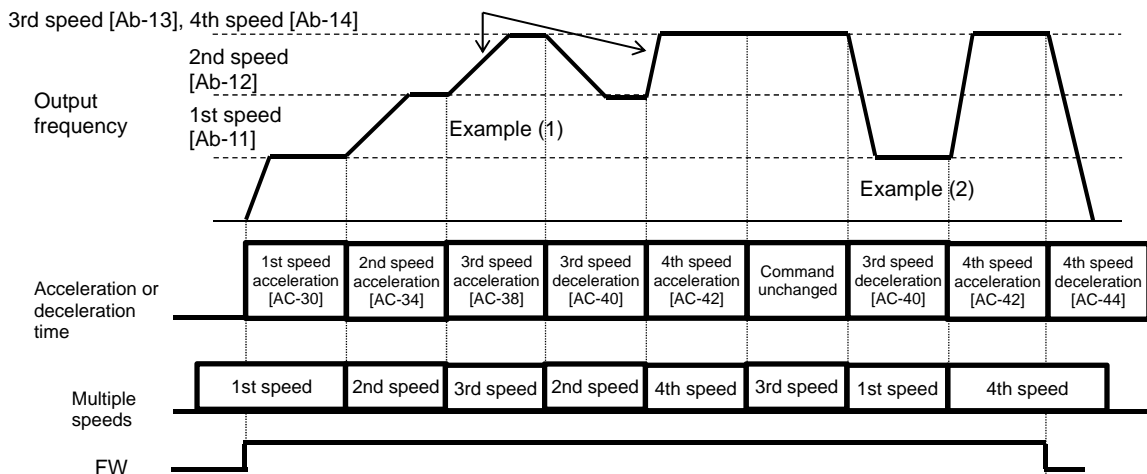

Example (1) If the multi-speed 3rd speed is engaged and the revolution is accelerating, the enabled acceleration time is the multi-speed 3rd speed acceleration time [AC-38].

Example (2) If the multi-speed 1st speed is engaged and the revolution is decelerating, the enabled deceleration time is the multi-speed 3rd speed deceleration time [AC-40] for the multi-speed 3rd speed that has been engaged until the multi-speed 1st speed is engaged.

■ Acceleration or deceleration time table

- The following table shows the multi-speed commands and their corresponding acceleration or deceleration times.

Setting state	Multi-speed command	Command state	Acceleration or deceleration time to be used
<p>The frequency after a speed is ON will be higher than the speed before that.</p> <p>To the accelerating state</p> <p>Acceleration time for multi-speed Mth speed</p>	1st speed ON	Multi-speed 1st speed [Ab-11] > Frequency before 1st speed is ON	Acceleration time for multi-speed 1st speed [AC-30]
	2nd speed ON	Multi-speed 2nd speed [Ab-12] > Frequency before 2nd speed is ON	Acceleration time for multi-speed 2nd speed [AC-34]
	3rd speed ON	Multi-speed 3rd speed [Ab-13] > Frequency before 3rd speed is ON	Acceleration time for multi-speed 3rd speed [AC-38]
	4th speed ON	Multi-speed 4th speed [Ab-14] > Frequency before 4th speed is ON	Acceleration time for multi-speed 4th speed [AC-42]
	5th speed ON	Multi-speed 5th speed [Ab-15] > Frequency before 5th speed is ON	Acceleration time for multi-speed 5th speed [AC-46]
	6th speed ON	Multi-speed 6th speed [Ab-16] > Frequency before 6th speed is ON	Acceleration time for multi-speed 6th speed [AC-50]
	7th speed ON	Multi-speed 7th speed [Ab-17] > Frequency before 7th speed is ON	Acceleration time for multi-speed 7th speed [AC-54]
	8th speed ON	Multi-speed 8th speed [Ab-18] > Frequency before 8th speed is ON	Acceleration time for multi-speed 8th speed [AC-58]
	9th speed ON	Multi-speed 9th speed [Ab-19] > Frequency before 9th speed is ON	Acceleration time for multi-speed 9th speed [AC-62]
	10th speed ON	Multi-speed 10th speed [Ab-20] > Frequency before 10th speed is ON	Acceleration time for multi-speed 10th speed [AC-66]
	11th speed ON	Multi-speed 11th speed [Ab-21] > Frequency before 11th speed is ON	Acceleration time for multi-speed 11th speed [AC-70]
	12th speed ON	Multi-speed 12th speed [Ab-22] > Frequency before 12th speed is ON	Acceleration time for multi-speed 12th speed [AC-74]
	13th speed ON	Multi-speed 13th speed [Ab-23] > Frequency before 13th speed is ON	Acceleration time for multi-speed 13th speed [AC-78]
	14th speed ON	Multi-speed 14th speed [Ab-24] > Frequency before 14th speed is ON	Acceleration time for multi-speed 14th speed [AC-82]
	15th speed ON	Multi-speed 15th speed [Ab-25] > Frequency before 15th speed is ON	Acceleration time for multi-speed 15th speed [AC-86]
	No multi-speed	Other than those above	Acceleration time [AC120]
<p>The frequency after a speed is OFF will be lower than the speed before that.</p> <p>To the decelerating state</p> <p>Deceleration time for multi-speed Nth speed</p>	1st speed OFF	Multi-speed 1st speed [Ab-11] > Frequency after 1st speed is OFF	Deceleration time for multi-speed 1st speed [AC-32]
	2nd speed OFF	Multi-speed 2nd speed [Ab-12] > Frequency after 2nd speed is OFF	Deceleration time for multi-speed 2nd speed [AC-36]
	3rd speed OFF	Multi-speed 3rd speed [Ab-13] > Frequency after 3rd speed is OFF	Deceleration time for multi-speed 3rd speed [AC-40]
	4th speed OFF	Multi-speed 4th speed [Ab-14] > Frequency after 4th speed is OFF	Deceleration time for multi-speed 4th speed [AC-44]
	5th speed OFF	Multi-speed 5th speed [Ab-15] > Frequency after 5th speed is OFF	Deceleration time for multi-speed 5th speed [AC-48]
	6th speed OFF	Multi-speed 6th speed [Ab-16] > Frequency after 6th speed is OFF	Deceleration time for multi-speed 6th speed [AC-52]
	7th speed OFF	Multi-speed 7th speed [Ab-17] > Frequency after 7th speed is OFF	Deceleration time for multi-speed 7th speed [AC-56]
	8th speed OFF	Multi-speed 8th speed [Ab-18] > Frequency after 8th speed is OFF	Deceleration time for multi-speed 8th speed [AC-60]
	9th speed OFF	Multi-speed 9th speed [Ab-19] > Frequency after 9th speed is OFF	Deceleration time for multi-speed 9th speed [AC-64]
	10th speed OFF	Multi-speed 10th speed [Ab-20] > Frequency after 10th speed is OFF	Deceleration time for multi-speed 10th speed [AC-68]
	11th speed OFF	Multi-speed 11th speed [Ab-21] > Frequency after 11th speed is OFF	Deceleration time for multi-speed 11th speed [AC-72]
	12th speed OFF	Multi-speed 12th speed [Ab-22] > Frequency after 12th speed is OFF	Deceleration time for multi-speed 12th speed [AC-76]
	13th speed OFF	Multi-speed 13th speed [Ab-23] > Frequency after 13th speed is OFF	Deceleration time for multi-speed 13th speed [AC-80]
	14th speed OFF	Multi-speed 14th speed [Ab-24] > Frequency after 14th speed is OFF	Deceleration time for multi-speed 14th speed [AC-84]
	15th speed OFF	Multi-speed 15th speed [Ab-25] > Frequency after 15th speed is OFF	Deceleration time for multi-speed 15th speed [AC-88]
	No multi-speed	Other than those above	Deceleration time [AC122]



- The switching timing of frequency command by multi-speed terminal command is different from that of the deceleration time.

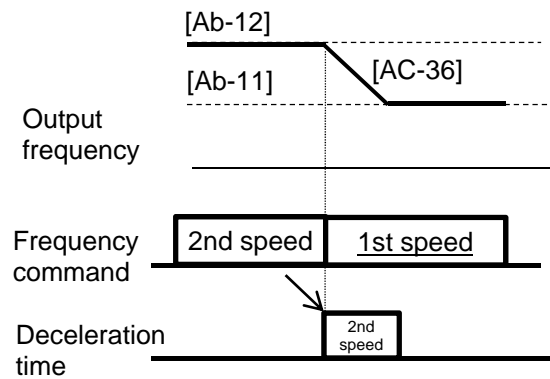
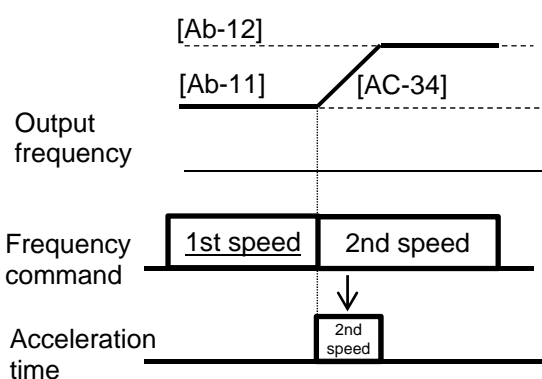

**12.8.4** Stagnate the acceleration or deceleration in the middle of its progress

**Q**

- To withhold temporarily the acceleration until the motor revolution follows the command in order to get a larger torque that is needed for starting the movement.
- To withhold the execution of the command until the frequency drops sufficiently in order to facilitate the deceleration that allows the complete stop of the motor.

**A**

- Use the hold function, which is more effective for a mechanical system that has a larger moment of inertia.
- The acceleration-hold function is to withhold further acceleration until the motor that is starting its revolution achieves a small enough slip. Use this function when an over current trip happens at the start of the motor revolution.
- The deceleration-hold function is to withhold further deceleration until the motor achieves a small enough slip. Use this function when an over voltage trip happens during deceleration.

■ Hold the frequency at any value for a set length of time.

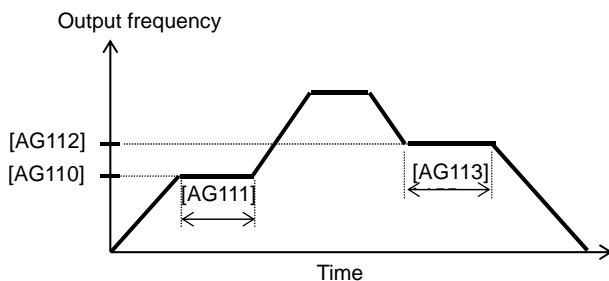

- The working of this function depends on none of the content of the acceleration pattern selection [AC-03] and that of the deceleration pattern selection [AC-04]. This function works for all the patterns.
- There are two methods of stopping the acceleration or deceleration, and they can be used together.
  - Stopping automatically at any frequency for any length of hold time.
  - Stopping by means of the Input terminal function.

■ To hold the frequency by means of the input terminal 100 [HLD] terminal function.

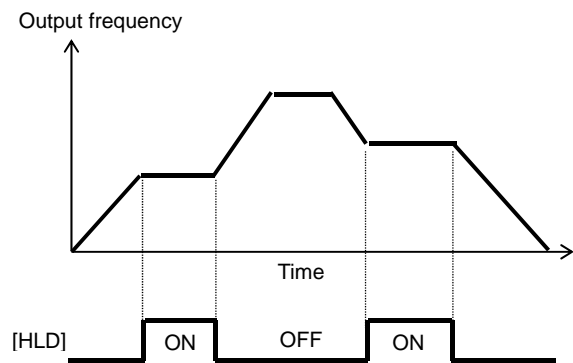

■ Parameter

Item	Parameter	Data	Description
Acceleration-hold frequency	[AG110]	0.00~590.00(Hz)	Setting the frequency at which the acceleration is withheld. A setting of 0.00 is not valid.
Acceleration-hold time	[AG111]	0.00~60.00(s)	Setting the length of time for which the acceleration is withheld.
Deceleration-hold frequency	[AG112]	0.00~590.00(Hz)	Setting the frequency at which the deceleration is withheld. A setting of 0.00 is not valid.
Deceleration-hold time	[AG113]	0.00~60.00(s)	Setting the length of time for which the deceleration is withheld.
Input terminal function selection	[CA-01]~[CA-11]	100	Using the acceleration- or deceleration-hold [HLD] function.

**12.8.5** Change the acceleration or deceleration pattern

**Q**

- To reduce such a large shock caused by an abrupt movement that will collapse the load being transported in lifts or on conveyors.
- To reduce the shock when the motor starts moving and when it is about to stop moving.
- To change the acceleration gradient in accordance with the winding or feeding amount.

**A**

- Setting a(n) acceleration or deceleration pattern is possible that suit each system.
- Setting the acceleration pattern selection and the deceleration pattern selection can be done independently of each other by means of [AC-03] and [AC-04], respectively.
- To use a(n) acceleration or deceleration pattern other than the linear one (00), a stable operation can be achieved by an command that can fix the target of the frequency command by means of the operator-keypad command and/or the multi-speed command.
- Even if a(n) acceleration or deceleration pattern is set, the acceleration time should be set at the time that it takes to rise from 0 Hz to the maximum frequency and the deceleration time should be set at the time it takes to fall from the maximum frequency to 0 Hz.

**!**

- Changing the acceleration or deceleration pattern from one to another will create a sector with a(n) acceleration or deceleration time having a steep gradient. If the occurrence of an over current/over voltage is predictable, it will be prevented by adjusting from happening, the acceleration or deceleration time has to be adjusted to prevent such an occurrence.
- When any other acceleration or deceleration pattern than the linear one (00) is set, a change of command value during the acceleration or deceleration may cause a recalculation of the acceleration or deceleration pattern, which may result in a shock.
- When any other acceleration or deceleration pattern than the linear one (00) is set, use any other command than the analog input one. An unsteady command value may cause a recalculation of the acceleration or deceleration pattern, which may prolong the actual acceleration or deceleration time.

**■ Pattern selection**

Select a pattern for each of the acceleration and the deceleration patterns by referring to the following table.

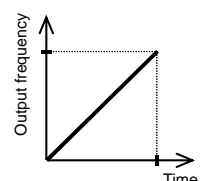
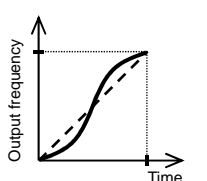
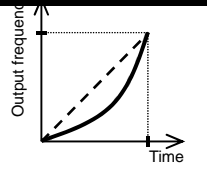
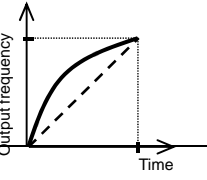
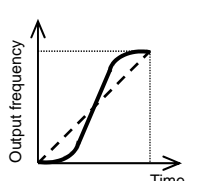
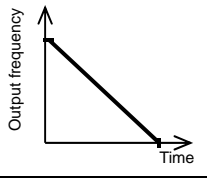
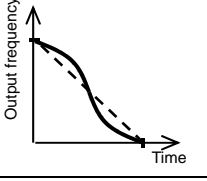
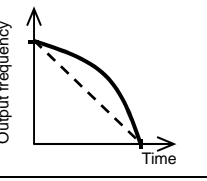
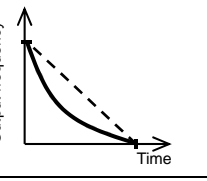
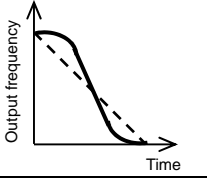
Set value	00	01	02	03	04
Curve	Linear	S-shaped	U-shaped	Inverse-U- shaped	EL-S-shaped
[AC-03] (Acceleration)					
[AC-04] (Deceleration)					
Description	Providing a linear acceleration up or deceleration down to the set frequency value.	Effective in the prevention of load collapse in lifts or on conveyors, for example.	Effective when a winder or the like needs to control of the tension and/or prevent the object to be wound from being cut. Usable for 1-shot winding/feeding.		Providing a shockless start/stop as in the case of the S-shaped curve, but providing a linear middle sector.

- Curve constant (degree of bulging) of pattern
- Determine the bulging degree by referring to the following figure.

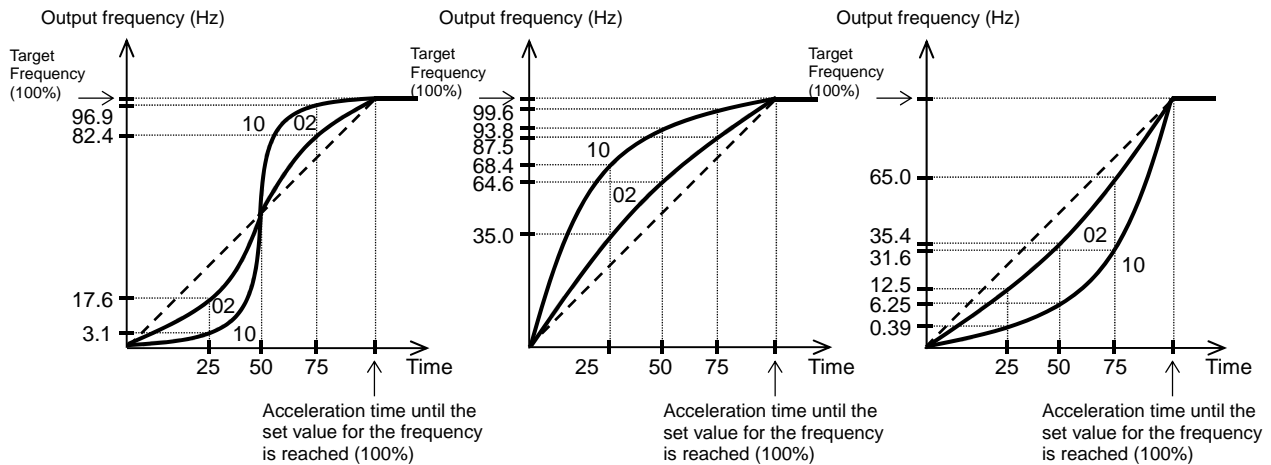

- EL-S-shaped curve's curvature
- Use of an EL-S-shaped curve allows the curvature settings [AC-08] to [AC-11] for acceleration/deceleration.

- Setting all the curvatures at 50 (%) makes the EL-S-shaped curve equivalent to an S-shaped curve.
- When setting the pair of [AC-08] and [AC-09] or that of [AC-10] and [AC-11], divide 100(%) into 2 segments, and assign one of which to the former of the pair and the other to the latter thereof (i.e., the two segments, if summed up, render a value up to 100%).
- A setting where [AC-08] = 100 and [AC-09] = 0 makes the acceleration curve a U-shaped acceleration curve.

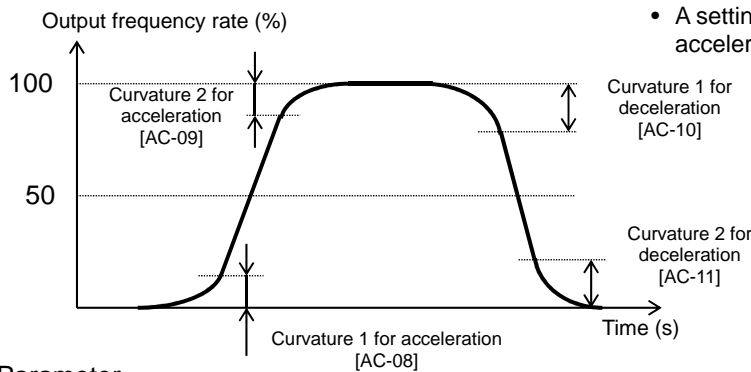

Parameter

Item	Parameter	Data	Description
Acceleration pattern selection Deceleration pattern selection	[AC-03] [AC-04]	00	Linear acceleration/deceleration
		01	S-shaped acceleration/deceleration
		02	U-shaped acceleration/deceleration
		03	Inverse-U-shaped acceleration/deceleration
		04	EL-S-shaped acceleration/deceleration
Acceleration curve constant	[AC-05]	1~10	1 (small bulging) ↕ 10 (large bulging)
Deceleration curve constant	[AC-06]		
Curvature 1 for EL-S-shaped acceleration	[AC-08]	0~100(%)	Designate the curvature of the curved sector when an EL-S-shaped pattern is used. (For acceleration)
Curvature 2 for EL-S-shaped acceleration	[AC-09]		
Curvature 1 for EL-S-shaped deceleration	[AC-10]	0~100(%)	Designate the curvature of the curved sector when an EL-S-shaped pattern is used. (For deceleration)
Curvature 2 for EL-S-shaped deceleration	[AC-11]		

### 12.8.6 Make the frequency follow the command instantaneously

**Q**

- To output the frequency in such a manner as the analog command requires it.
- To make the motor follow the command as fast as possible.

**A**

- If the acceleration or deceleration cancel [LAC] function is selected as the input terminal function selection and the signal is turned ON, the acceleration or deceleration time becomes ignored and the output frequency is made instantaneously to follow the set frequency.



- As the use of the acceleration or deceleration cancellation function makes the output follow the command, a large amount of increase/decrease in the frequency demanded by the command may cause a trip.
- [LAC] function is valid for any frequency command such as one from parameter set-up, one from the communication, and so on.

Item	Parameter	Data	Description
Input terminal function selection	[CA-01]~[CA-11]	071	Acceleration or deceleration cancellation function [LAC] is selected. Canceling the acceleration or deceleration and making the output follow the command.

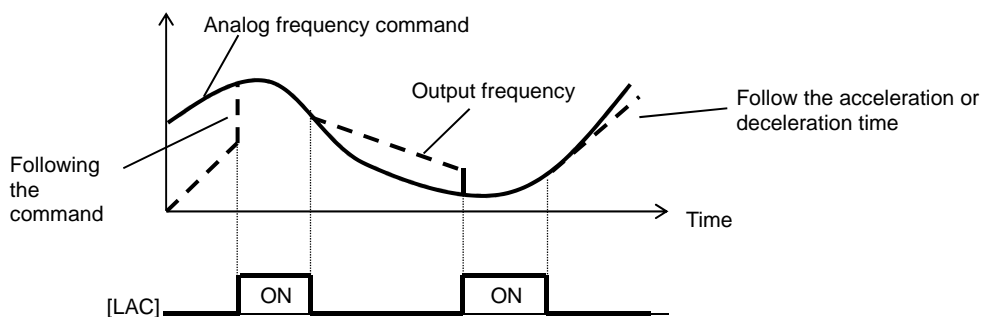





## 12.9 Select motor control method in accordance with motor and load

### 12.9.1 Selection of control mode

**Q**

- To run the a fan/pump with settings that provide a better energy-saving effect.
- To change the frequency-voltage characteristics of a high-speed motor/special motor freely as intended.
- To run multiple motors with a single inverter.

**A**

- Select an appropriate motor control mode for the motor to be driven and the control method.
- Set [AA121] = 11 or 12 to drive a synchronous motor (SM)/permanent magnet motor (PMM).
- The characteristics of the control operation may be improved by automatic tuning.
- Whether the currently-selected mode is the control mode for induction motors or that for synchronous motors (SMs)/permanent magnet motors (PMMs) can be checked by [dC-45] IM/SM(PMM) monitor.

- To conduct high-torque control of conveyors or the like without using encoder feedback.
- To conduct high-torque control of cranes and lifts from 0 Hz without using encoder feedback.
- To control the torque in order to conduct hit-and-stop control as well as tension control.

**!**

- As improper settings for a given motor result in performance below its potential characteristics, be sure to set up appropriately.
- See "12.3 Basic Settings for Motor" for checking.
- To drive multiple induction motors (IMs) by a single inverter, it is recommendable to use it with V/f control's constant torque characteristics.
- An exemplar selection of control mode will be shown in the following section. Some of your systems may have more suitable modes than what is selected as the example.

#### Parameter

Item	Parameter	Data	Description
Control mode	[AA121]	00	V/f control-constant torque characteristics (IM)
		01	V/f control-reducing torque characteristics (IM)
		02	V/f control-free V/f (IM)
		03	Automatic torque boost (IM)
		04	V/f control-constant torque characteristics (IM) with sensor
		05	V/f control-reducing torque characteristics (IM) with sensor
		06	V/f control with sensor-free V/f (IM)
		07	Automatic torque boost (IM) with sensor
		08	Sensorless vector control (IM)
		09	Zero-Hz range sensorless vector control (IM)
		10	Vector control (IM) with sensor
		11	Synchronous-start type sensorless vector control (SM (PMM))
		12	IVMS-start type sensorless vector control (SM (PMM))
IM/SM(PMM) monitor	[dC-45]	00	Induction motor IM being selected.
		01	Synchronous motor SM (permanent magnet motor PMM) being selected.

\* IM : Induction motor  
SM (PMM) : Synchronous motor (permanent magnet motor)



1 Check the motor type.

- Use an induction motor (IM).  
**Proceed to #2**

- To use a synchronous motor (SM)/permanent magnet motor (PMM).  
**Proceed to "12.9.12 Drive synchronous motor (permanent magnet motor)."**

2 Select a control mode.

- No feedback is to be used.

- To use in applications, such as lifts and cranes, that require a high torque from the start.  
**Proceed to "12.9.10 Use zero-speed range (zero-Hz range) sensorless vector control."**

- To use in applications, such as conveyors and machine tools, that carry heavy loads and require a high torque.  
**Proceed to "12.9.9 Use sensorless vector control."**

- To use in applications where the frequency-voltage characteristics of a high-speed motor/special motor need to be changed freely as intended.  
**Proceed to "12.9.4 Drive with free V/f control."**

- To use in applications that require a certain torque at the start though the load is light.  
**Proceed to "12.9.6 Manually adjust torque." or**  
**Proceed to "12.9.7 Automatically adjust torque."**

- To save energy with V/f control appropriately to a fan/pump.  
**Proceed to "12.9.3 Drive with V/f control (reducing torque characteristics)."**

- To use with generic characteristics of V/f control.  
**Proceed to "12.9.2 Drive with V/f control (constant torque characteristics)"**

- To use in applications that require feedback from encoders, sensors, etc.

- To use in applications: that carry a heavy load; that require control needing a high torque; and that require position control.  
**Proceed to "12.9.11 Drive with vector control with sensor."**

- To use in applications where a motor with an encoder is driven and the frequency-voltage characteristics of the motor need to be changed freely as intended.  
**Proceed to "12.9.15 Drive with free V/f control with sensor."**

- To use in applications: where a motor with an encoder is driven; that require a certain torque at the start; and where the motor revolution speed needs to be equal to the command speed.  
**Proceed to "12.9.16 Use automatic boost function with sensor."**

- To use in applications where a fan/pump with an encoder is driven and where the motor revolution speed needs to be equal to the command speed while the energy consumption needs to be reduced.  
**Proceed to "12.9.14 Drive with V/f control with sensor (reducing torque characteristics)."**

- To use in applications where a motor with an encoder is driven and where the motor needs to be used with generic characteristics of V/f control.  
**Proceed to "12.9.13 Drive with V/f control with sensor (constant torque characteristics)."**



- To conduct encoder feedback, see also "12.9.17 Use encoder."

**12.9.2** Drive with V/f control (constant torque characteristics)

**Q**

- To use with a load for running conveyors and bogies.
- To use in a fan/pump that changes its output frequently.
- To avoid trips that may be likely to happen when driven with reducing torque characteristics.
- To run multiple motors with a single inverter.

**A**

- V/f control (constant torque characteristics)
  - With constant torque characteristics, the output voltage is outputted proportionally to a given command frequency along the straight line drawn from the point 0 Hz/0 V to the intersection of the base frequency and the rated voltage.
  - The output voltage corresponding to a frequency range from 0 Hz to the base frequency is determined proportionally to the given frequency, but the output voltage corresponding to a frequency range from the base frequency to the maximum frequency is constant irrespective of the frequency.
  - Use of the manual boost function renders the output voltage higher than that on the basic proportional line by the boost voltage. The manual boost function is effective in the case of low speeds and insufficient torque.



- When a motor is hunting and vibrating, an adjustment of the stability constant [HA110] may improve the state of the motor.
- When a single inverter runs multiple motors and the motors are vibrating, a downward adjustment of the stability constant [HA110] may stabilize the state of the motors.

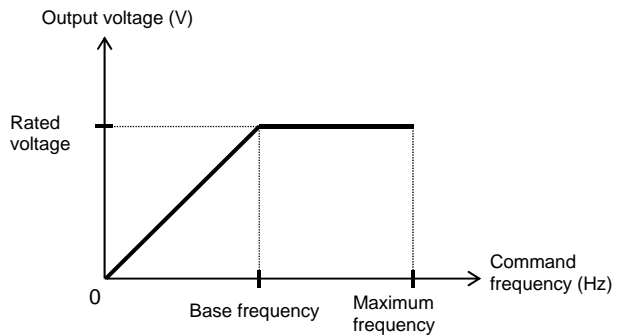

■ Parameter

Item	Parameter	Data	Description
Control mode	[AA121]	00	To be used with the V/f control and the constant torque characteristics (IM).
Stability constant	[HA110]	0~1000(%)	To adjust the control for reducing the hunting of motors.
Base frequency	[Hb104]	10.00 to the maximum frequency (Hz)	To set the base frequency of motors.
Maximum frequency	[Hb105]	Base frequency to 590.00 (Hz)	To set the maximum frequency of motors.
Motor's rated voltage	[Hb106]	1~1000 (V)	Set the rated voltage of motors.

**12.9.3** Drive with V/f control (reducing torque characteristics)



- To reduce the output voltage in accordance with the fan/pump's characteristics in order to get a higher energy-saving effect.
- To use in a more efficient state with less vibration and lower noise, because no large torque is necessary at lower speeds.



- V/f control (reducing torque characteristics)
- Suitable for applications, such as a fan/pump, that require no large torque at a low-speed range.

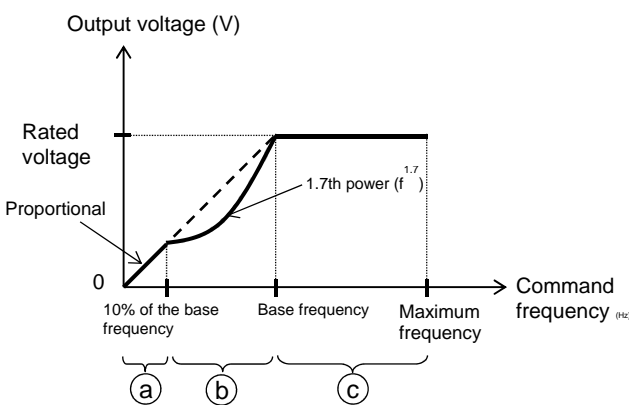

- When a motor is hunting and vibrating, an adjustment of the stability constant [HA110] may improve the state of the motor.

- As the output voltage is low at a low-speed range, improved efficiency, lower noise, and less vibration can be expected.

Period a: Constant torque characteristics are employed for a period from 0 Hz to the frequency that is 10% of the base frequency. (e.g.) A 60-Hz base frequency yields constant torque characteristics for a range from 0 to 6 Hz.

Period b: Reducing torque characteristics are employed for a period from the frequency that is 10% of the base frequency to the base frequency. For a given frequency, the voltage on the curve of the 1.7th power to the given frequency is outputted.

Period c: The voltage has constant-output characteristics for a range from the base frequency to the maximum frequency.

■ Parameter

Item	Parameter	Data	Description
Control mode	[AA121]	01	To be used with the V/f control and the reducing torque characteristics (IM).
Stability constant	[HA110]	0~1000(%)	To adjust the control for reducing the hunting of motors.
Base frequency	[Hb104]	10.00 to the maximum frequency (Hz)	To set the base frequency of motors.
Maximum frequency	[Hb105]	Base frequency to 590.00 (Hz)	To set the maximum frequency of motors.
Motor's rated voltage	[Hb106]	1~1000 (V)	Set the rated voltage of motors.

**12.9.4** Run with V/f control (free V/f)



- To change the characteristics of V/f control in accordance with the voltage characteristics of a special motor.
- To adjust manually the voltage characteristics to optimal ones in order to save energy.



- V/f control (free V/f)
- In the free V/f set-up, any intended V/f characteristics can be set by setting the voltage and the frequency at 7 points.

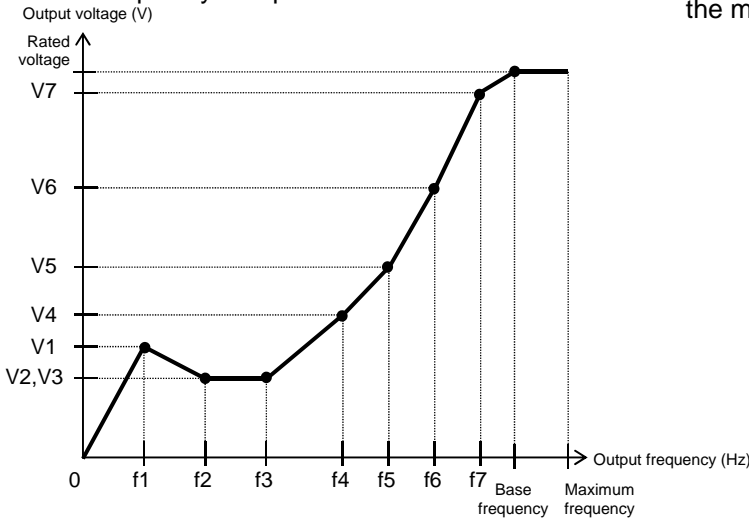

- When a motor is hunting and vibrating, an adjustment of the stability constant [HA110] may improve the state of the motor.
- The frequencies set by free V/f set-up have to always meet the following requirement:  $f1 \leq f2 \leq f3 \leq f4 \leq f5 \leq f6 \leq f7 \leq$  base frequency. The initial value for each of the frequencies set by the free V/f set-up is 0 Hz. Set the maximum frequency and the base frequency first, and then set the frequencies f7, f6, f5, f4, f3, f2, and f1 in this order by the free V/f set-up.
- Setting the [AA121] at 02 (free V/f set-up) disables the manual torque boost operation mode [Hb140].

■ Parameter

Item	Parameter	Data	Description
Control mode	[AA121]	02: Free V/f (IM)	To use the free V/f (IM)
Stability constant	[HA110]	0~1000(%)	To adjust the control for reducing the hunting of motors.
Base frequency	[Hb104]	10.00 to the maximum frequency (Hz)	To set the base frequency of motors.
Maximum frequency	[Hb105]	Base frequency to 590.00 (Hz)	To set the maximum frequency of motors.
Motor's rated voltage	[Hb106]	1~1000 (V)	Set the rated voltage of motors.
Free V/f frequency 7	[Hb162]	[Hb160] to the base frequency (Hz)	Set the frequency at each break point.
Free V/f frequency 6	[Hb160]	[Hb158]~[Hb162] (Hz)	
Free V/f frequency 5	[Hb158]	[Hb156]~[Hb160] (Hz)	
Free V/f frequency 4	[Hb156]	[Hb154]~[Hb158] (Hz)	
Free V/f frequency 3	[Hb154]	[Hb152]~[Hb156] (Hz)	
Free V/f frequency 2	[Hb152]	[Hb150]~[Hb154] (Hz)	
Free V/f frequency 1	[Hb150]	0.00~[H152](Hz)	
Free V/f voltage 7	[Hb163]	0.0~1000.0(V)	Set the output voltage at each break point.
Free V/f voltage 6	[Hb161]		
Free V/f voltage 5	[Hb159]		
Free V/f voltage 4	[Hb157]		
Free V/f voltage 3	[Hb155]		
Free V/f voltage 2	[Hb153]		
Free V/f voltage 1	[Hb151]		



- Even the setting of 1000 V for all of the free V/f voltages 1 to 7 will not enable the inverter to output a voltage that is higher than the input voltage or the motor's voltage selection.

- Set the characteristics very carefully because inappropriate characteristic settings may cause over current to happen during the acceleration or deceleration and/or may cause machine vibration.

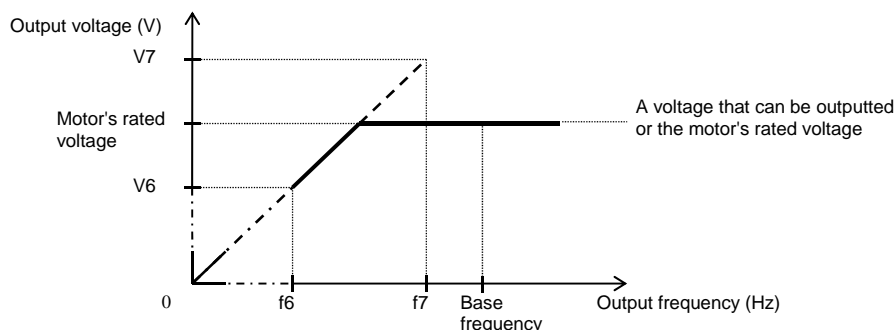

### 12.9.5 Run in the energy-saving mode



- To save energy by using a load corresponding to slower acceleration or deceleration and to a wide range of constant frequency.



- Set **automatic adjustment** so as to achieve the minimum output power of the inverter during constant-speed operation. Suitable for the load corresponding to the reducing torque characteristics of a fan/pump.
- Running with this function needs a setting of 01 for the energy-saving operation selection [Hb145]. The response and the accuracy can be adjusted by the energy-saving response/accuracy adjustment [Hb146].



- Because this function is implemented by relatively slow control, a rapid change in load, such as an impact load, may stall the motor and cause an over current trip
- This function acts when either the V/f control (constant torque characteristics) or the V/f control (reducing torque characteristics) is selected.

#### ■ Parameter

Item	Parameter	Data	Description		
Energy-saving operation selection	[Hb145]	00: disabled; 01: enabled	Select whether or not to conduct the energy-saving operation.		
Energy-saving response/accuracy adjustment	[Hb146]	0~100(%)	Setting	Response	Accuracy
			0 ↕ 100	Slow ↕ Fast	High ↕ Low



12.9.6 Manually adjust torque



- To improve the delayed start of the motor from the start of the operation.
- To improve the small torque at low speeds.



- Raise the output voltage by adding an extra voltage in order to achieve a higher torque at low speeds than otherwise.
- In the V/f control, no special correction is conducted to control the motor. Accordingly, at low output voltages, the resistance component and/or the wiring in the motor will cause the voltage drop, which in turn lowers the voltage applied to the motor. Manual boost corrects the voltage and thereby improves the lowering of the torque at the low-speed range.

e.g.) When [Hb140] = 02, the boost works only for the forward revolution of the motor.

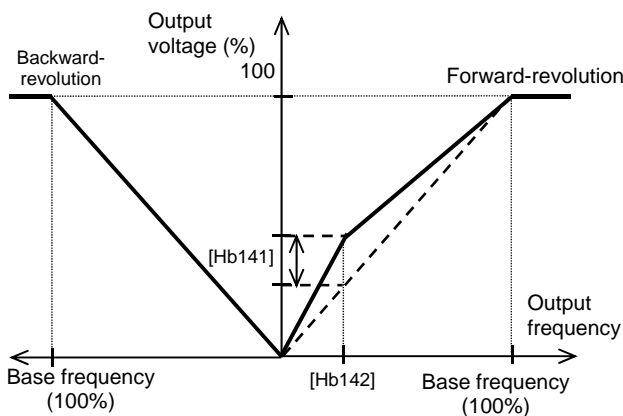

- Be sure not to cause an over excitation of the motor when raising the set value for the manual torque boost. Boosting increases the flow of the current, which may burn the motor.
- The target of the torque boost is the V/f control of induction motors. (except the free V/f)
- As the amount of manual torque boost [Hb141], set the proportion thereof to the motor rated voltage [Hb106] (= 100 %). The set value is the maximum amount to be added at manual torque boost break point [Hb142].
- As the manual torque boost break point [Hb142], set the proportion of the frequency at that point to the base frequency [Hb104] (= 100%).

Parameter

Item	Parameter	Data	Description
Torque boost operation mode selection	[Hb140]	00	Disabled
		01	Always enabled
		02	Enabled only for forward revolution
		03	Enabled only for backward revolution
Amount of manual torque boost	[Hb141]	0.0~20.0(%)	Setting the maximum amount of torque boost for the motor's rated voltage [Hb106] at the time of setting the manual torque boost break point.
Manual torque boost break point	[Hb142]	0.0~50.0(%)	Set, as the break point, the proportion of the boost amount to the base frequency [Hb104]

### 12.9.7 Automatically adjust torque



- To improve the delayed start of the motor from the start of the operation.
- A heavy load slows the motor revolution relative to what the frequency command dictates.



- Automatically adjust the frequency and the output voltage so as to achieve a higher torque.
- The automatic boost corrects the frequency and the output in order to control the motor. Accordingly, it requires the acquisition of the motor constant by means of auto-tuning or the like.



- When a motor is hunting and vibrating, an adjustment of the stability constant [HA110] may improve the state of the motor.
- In the automatic torque boost, set the motor capacity appropriately, the number of motor poles, the base frequency, the rated voltage, and the rated current in order to conduct motor control.
- When the motor performs below its potential characteristics, conduct the auto-tuning and make adjustment by referring to the next section.

#### ■ Parameter

Item	Parameter	Data	Description
Control mode	[AA121]	03	To use the automatic torque boost (IM).
Stability constant	[HA110]	0~1000(%)	To adjust the control for reducing the hunting of motors.
Base frequency	[Hb104]	10.00 to the maximum frequency (Hz)	To set the base frequency of motors.
Maximum frequency	[Hb105]	Base frequency to 590.00 (Hz)	To set the maximum frequency of motors.
Motor's rated voltage	[Hb106]	1~1000 (V)	Set the rated voltage of motors.
Automatic torque boost voltage compensation gain	[HC101]	0~255	To adjust the amount of the voltage added by the automatic torque boost.
Automatic torque boost Slip compensation gain	[HC102]	0~255	To adjust the amount of the frequency added by the automatic torque boost.

Phenomenon▶	Estimated cause(s)▶	Exemplar measures to be taken
Slower motor revolution at low speeds than what is expected	<ul style="list-style-type: none"> <li>Insufficient output voltage, which in turn renders the torque insufficient</li> </ul>	<ul style="list-style-type: none"> <li>Make an adjustment by incrementing the automatic torque boost voltage compensation gain [HC101] by approximately 5% each time.</li> </ul>
	<ul style="list-style-type: none"> <li>Insufficient frequency correction, which in turn renders the torque insufficient.</li> </ul>	<ul style="list-style-type: none"> <li>Make an adjustment by incrementing the automatic torque boost slip compensation gain [HC102] by approximately 5% each time</li> </ul>
A heavy load lowers the revolution frequency of the motor.	<ul style="list-style-type: none"> <li>Insufficient frequency correction, which in turn renders the torque insufficient.</li> </ul>	<ul style="list-style-type: none"> <li>Make an adjustment by incrementing the automatic torque boost slip compensation gain [HC102] by approximately 5% each time</li> </ul>
A heavy load raises the revolution frequency of the motor.	<ul style="list-style-type: none"> <li>An excessive frequency correction raises the frequency.</li> </ul>	<ul style="list-style-type: none"> <li>Make an adjustment by decrementing the automatic torque boost slip compensation gain [HC102] by approximately 5% each time</li> </ul>
With a heavy load, an acceleration causes an over current.	<ul style="list-style-type: none"> <li>An excessive voltage correction increases the current.</li> </ul>	<ul style="list-style-type: none"> <li>Make an adjustment by decrementing the automatic torque boost voltage compensation gain [HC101] by approximately 5% each time.</li> </ul>
	<ul style="list-style-type: none"> <li>An excessive frequency correction raises the frequency.</li> </ul>	<ul style="list-style-type: none"> <li>Make an adjustment by decrementing the automatic torque boost slip compensation gain [HC102] by approximately 5% each time</li> </ul>



- When the revolution of the motor is hindered by breaking or the motor lock caused by foreign objects may cause over current or the like. When no such adjustment as ones mentioned above improves the state, checking the portion around the motor may sometimes improves it.
- If an application of load results in a great amount of change in the inverter's output frequency monitor [dA-01], functions which change automatically change the frequencies for the overload limiting function, the momentary-stop non-stop function, the over voltage suppression function may work depending upon the settings of the functions. For details, see "Chap. 18: Tips/FAQ/Troubleshooting."

### 12.9.8 Stabilize motor revolution



- To improve the unstable state of the motor caused by the vibration that occurs at a certain frequency or higher.



- This is a function to adjust the motor that is hunting to achieve a stable state. Search a set range for a point where the hunting stops, and make an adjustment accordingly.
- When a single inverter drives multiple motors, setting the stability constant at 0 may improve the state.
- When a load with large inertia such as a fan is rotated, decrementing the stability constant [HA110] by 10% each time may improve the state.
- When the motor capacity is smaller than the rated capacity of the inverter, incrementing the set value by 10% each time may improve the state. In contrast, when the motor capacity is larger than the rated capacity of the inverter, decrementing the set value by 10% each time may improve the state.



- If the motor is hunting and vibrating, check if appropriate settings are provided for the motor capacity, the number of motor poles, the base frequency, the rated voltage, and the rated current.
- Then conduct the auto-tuning to check if the hunting ends, and adjust the stability constant.
- Exemplar methods of reducing the hunting include the following methods:
  1. Adjust the carrier frequency [bb101] by gradually decrementing it down to 2 kHz.
  2. Adjust the output voltage gain [Hb180] by gradually decrementing it down to 80%.
 If no effect can be observed, restore the original values.



- Do not conduct a steady operation with a setting for the output voltage gain [Hb180] that exceeds 100%. The motor may be burned.

#### ■ Parameter

Item	Parameter	Data	Description
Stability constant	[HA110]	0~1000(%)	To adjust the control for reducing the hunting of motors.
Output voltage gain	[Hb180]	0~255(%)	Decrease it if the motor is hunting. A lower setting decreases the output voltage.
Carrier frequency	[bb101]	0.5~16.0(kHz) *)	Change the carrier frequency of the PWM output. If the motor is hunting, lower the setting.

\*) Some settings may limit the carrier frequency. For details, see "12.12 Adjust motor sound, noise, and heat production of inverter."

### 12.9.9 Use sensorless vector control



- The motor has a slow response of frequency.
- More torque is needed.
- To use in applications that require a high torque at the start.
- To control the frequency accurately.
- A heavy load slows the motor revolution relative to what the frequency command dictates.



- Automatically adjust the frequency and the output voltage so as to achieve responsively a higher torque even at slow speeds.
- In the sensorless vector control, to control the motor, the frequency and the output voltage are corrected and the response is adjusted with respect to the load inertia.
- Even in the case of Hitachi's standard motors, a large load inertia and/or a long wiring may require the auto-tuning.
- Use of other motors than Hitachi's standard motors requires the setting-up of the motor constant and the load inertia by, for example conducting the auto-tuning.



- In the sensorless vector control, set appropriately the motor capacity, the number of motor poles, the base frequency, the rated voltage, and the rated current in order to conduct motor control.
- When the motor performs below its potential characteristics, conduct the auto-tuning and make adjustment by referring to the next section.
- In the case of a long wiring (approximately longer than 20 m) and in the case of controlling motors other than our company's, the performance may be below what are expected from the characteristics.
- As the capacity becomes farther away from the maximum applicable motor capacity, sufficient operation characteristics becomes more difficult to get.
- In the sensorless vector control, adjustment of the response is possible. The sensorless vector control can be used in applications that require a better follow-up performance of the frequency to the command.
- When a motor is hunting and vibrating, an adjustment of the speed response [HA115] may improve the state of the motor.
- To limit the output direction by enabling the reversal prevention function [HC114].
- To correct the slip change caused by temperature changes by enabling the selection of the secondary resistance correction [HC113]. Connection is needed between a thermistor for measuring the temperature of the motor and the TH terminal.

#### Parameter

Item	Parameter	Data	Description
Control mode	[AA121]	08	To use the sensorless vector control (IM).
Speed response	[HA115]	0~1000(%)	To adjust the responsiveness of the control. A larger value enhances the responsiveness.
Amount of boost at the start(sensorless vector)	[HC111]	0~50(%)	To adjust the current command at the start when the starting torque is not sufficient.
Selection of whether a secondary-resistance correction is to be conducted.	[HC113]	00	Disabled
		01	Enabled Requiring a temperature thermistor.
Selection of reversal prevention	[HC114]	00	Disabled
		01	Enabled Limit the output to prevent the output in the reverse direction.
Time constant for torque current command filter	[HC120]	0~100(ms)	To adjust the filter for the torque current.
Speed feed forward compensation adjustment gain	[HC121]	0~1000(%)	To adjust the feed forward control of the speed controller.

Phenomenon▶	Estimated cause(s)▶	Exemplar measures to be taken
Socks occur during the revolutions at the start.	<ul style="list-style-type: none"> <li>The control system has a speed response that is too high.</li> </ul>	<ul style="list-style-type: none"> <li>Make an adjustment by decrementing the response adjustment [HA115] by 5% each time.</li> <li>Make an adjustment by decrementing the IM motor constant J [Hb118] by 5% each time.</li> <li>Make an adjustment by decrementing the boost amount at the start [HC111] by 5% each time.</li> </ul>
Unsteady revolutions at low speeds, resulting in fluctuating revolutions.	<ul style="list-style-type: none"> <li>The control system has a speed response that is too low.</li> </ul>	<ul style="list-style-type: none"> <li>Make an adjustment by incrementing the response adjustment [HA115] by 5% each time.</li> <li>Make an adjustment by incrementing the IM motor constant J [Hb118] by 5% each time.</li> </ul>
The motor is hunting.	<ul style="list-style-type: none"> <li>The control system has a speed response that is too low.</li> </ul>	<ul style="list-style-type: none"> <li>Make an adjustment by decrementing the response adjustment [HA115] by 5% each time.</li> <li>Make an adjustment by decrementing the IM motor constant J [Hb118] by 5% each time.</li> </ul>
When a load in the motor-stopping direction is applied to the motor, the revolution frequency becomes lower.	<ul style="list-style-type: none"> <li>The motor constant R2 is set at too small a value.</li> </ul>	<ul style="list-style-type: none"> <li>Make an adjustment by incrementing the IM motor constant R2 [Hb112] by 5% of the current value each time.</li> </ul>
When a load in the motor-stopping direction is applied to the motor, the revolution frequency becomes higher.	<ul style="list-style-type: none"> <li>The motor constant R2 is set at too large a value.</li> </ul>	<ul style="list-style-type: none"> <li>Make an adjustment by decrementing the IM motor constant R2 [Hb112] by 5% of the current value each time.</li> </ul>
When a load in the motor-stopping direction is applied to the motor, the revolution frequency becomes higher.	<ul style="list-style-type: none"> <li>Insufficient regenerative torque at low speeds.</li> </ul>	<ul style="list-style-type: none"> <li>Make an adjustment by incrementing the IM motor constant R1 [Hb110] by 5% of the current value each time.</li> <li>Make an adjustment by incrementing the IM motor constant I0 [Hb116] by 5% of the current value each time.</li> </ul>
Revolution in the opposite direction to the command direction occurs for an instant.	<ul style="list-style-type: none"> <li>A command demanding the revolution in the opposite direction is dispatched over the control system for an instant.</li> </ul>	<ul style="list-style-type: none"> <li>Enable the reversal prevention selection [HC114].</li> </ul>



- Set the carrier frequency [bb101] at a value of 2.0 kHz or higher. A set frequency of 1.9 kHz or lower may cause hunting.
- When the revolution of the motor is hindered by breaking or the motor lock caused by foreign objects may cause over current or the like. When no such adjustment as ones mentioned above improves the state, checking the portion around the motor may sometimes improves it.
- If an application of load results in a great amount of change in the inverter's output frequency monitor [dA-01], functions which change automatically change the frequencies for the overload limiting function, the momentary-stop non-stop function, the over voltage suppression function may work depending upon the settings of the functions. For details, see "Chap. 18: Tips/FAQ/Troubleshooting."

### 12.9.10 Use zero-speed range (zero-Hz range) sensorless vector control



- To use in applications, such as cranes, that require a high torque at the start.
- To accurately control the frequency.



- Automatically adjust the frequency and the output voltage so as to achieve responsively a higher torque even at slow speeds.
- In the zero-speed range sensorless vector control, the sensorless vector control is supplemented with an output that can achieve an intended torque from at extremely low speeds such as those in the zero-speed range.
- Even in the case of Hitachi's standard motors, a large load inertia and/or a long wiring may require the auto-tuning.
- Use of other motors than Hitachi's standard motors requires the setting-up of the motor constant and the load inertia by, for example conducting the auto-tuning.
- As in the case of the sensorless vector control, acquire the motor constant by means of auto-tuning or the like.



- In the zero-speed range sensorless vector control, as in the case of the sensorless vector control, set appropriately the motor capacity, the number of motor poles, the base frequency, the rated voltage, and the rated current in order to conduct motor control.
- When the motor performs below its potential characteristics, conduct the auto-tuning and make adjustment by referring to the next section.
- In the case of a long wiring (approximately longer than 20 m) and in the case of controlling motors other than out company's, the performance may be below what are expected from the characteristics.
- As the capacity becomes farther away from the maximum applicable motor capacity, sufficient operation characteristics becomes more difficult to get.
- In the zero-speed range sensorless vector control, as in the case of the sensorless vector control, adjustment of the response is possible. In addition to the adjustment of the response, it is possible to set the torque boost for the current at the start.
- When a motor is hunting and vibrating, an adjustment of the speed response [HA115] may improve the state of the motor.

#### ■ Parameter

Item	Parameter	Data	Description
Control mode	[AA121]	09	To use the zero-speed range sensorless vector control (IM) function.
Speed response	[HA115]	0~1000(%)	To adjust the responsiveness of the control. A larger value enhances the responsiveness.
Zero-speed range limiter	[HC110]	0~100(%)	To limit the current at the start so as not to allow the rising of the current to rise too high.
Amount of boost at the start (zero-speed range sensorless vector)	[HC112]	0~50(%)	To adjust the current command at the start when the starting torque is not sufficient.
Time constant for torque current command filter	[HC120]	0~100(ms)	To adjust the filter for the torque current.
Speed feed forward compensation adjustment gain	[HC121]	0~1000(%)	To adjust the feed forward control of the speed controller.

- In addition to the adjustment of the sensorless vector control, refer to the following description.

Phenomenon▶	Estimated cause(s)▶	Exemplar measures to be taken
Socks occur during the revolutions at the start.	• Boost amount is too large.	<ul style="list-style-type: none"> <li>• Make an adjustment by decrementing the zero-speed range limiter [HC110] by 5% each time.</li> <li>• Make an adjustment by decrementing the zero-speed range boost at the start [HC112] by 5% each time.</li> </ul>
Over current occurs at the start		
The motor cannot provide enough torque for the load is too high for the motor to at the start.	• Boost amount is too small.	<ul style="list-style-type: none"> <li>• Make an adjustment by incrementing the zero-speed range boost at the start [HC112] by 5% each time.</li> </ul>
Acceleration is not possible.		



- Set the carrier frequency [bb101] at a value of 2.0 kHz or higher. A set frequency of 1.9 kHz or lower may cause hunting.
- When the revolution of the motor is hindered by breaking or the motor lock caused by foreign objects may cause over current or the like. When no such adjustment as ones mentioned above improves the state, checking the portion around the motor may sometimes improves it.
- If an application of load results in a great amount of change in the inverter's output frequency monitor [dA-01], functions which change automatically change the frequencies for the overload limiting function, the momentary-stop non-stop function, the over voltage suppression function may work depending upon the settings of the functions. For details, see "Chap. 18: Troubleshooting."



### 12.9.11 Use vector control with sensor

#### Q

- To conduct highly accurate control on the motor with encoder feedback.
- To use the position control function.

#### A

- The feedback of the encoder signal from the motor allows highly accurate frequency control from the low-speed range.
- In the vector control with sensor, to control the motor, the frequency and the output voltage are corrected and the response is adjusted with respect to the load inertia. Accordingly, it requires the acquisition of the motor constant and the load inertia by means of auto-tuning or the like.
- In the vector control with sensor, adjustment of the response is possible. The vector control with sensor can be used in applications that require a better follow-up performance of the speed to the command.
- In the vector control with sensor, the position control mode can be used.
- Even in the case of Hitachi's standard motors, a large load inertia and/or a long wiring may require the auto-tuning.
- Use of other motors than Hitachi's standard motors requires the setting-up of the motor constant and the load inertia by, for example conducting the auto-tuning.
- When a motor is hunting and vibrating, an adjustment of the speed response [HA115] may improve the state of the motor.



- Conducting the vector control with sensor requires the encoder feedback from the motor.
- When [CA-90] = 02, Input terminals [A] and [B] are switched to the terminals for feedback control. When [CA-90] ≠ 02, terminals [EAP], [EBP], [EAN], and [EBN] of the feedback option P1-FB are enabled.

See "12.9.17 Use encoder."

- In the vector control with sensor, set appropriately the motor capacity, the number of motor poles, the base frequency, the rated voltage, and the rated current in order to conduct motor control.
- As the motor's frame number becomes smaller and smaller from the one of the maximum applicable motor, sufficient operation characteristics becomes more difficult to get.
- In the case of a long wiring (approximately longer than 20 m) and in the case of controlling motors other than our company's, the performance may be below what are expected from the characteristics.
- As the motor's frame number becomes smaller and smaller from the one of the maximum applicable motor, sufficient operation characteristics becomes more difficult to get.

#### ■ Parameter

Item	Parameter	Data	Description
Control mode	[AA121]	10	To use the vector control with sensor (IM).
Speed response	[HA115]	0~1000(%)	To adjust the responsiveness of the control. A larger value enhances the responsiveness.
Vector control mode selection	[AA123]	00	Operation is possible by switching between the speed control and the torque control.
		01	Activate the pulse train position control mode.
		02	Activate the absolute position control mode.
		03	Activate the high-resolution absolute position control mode.

Phenomenon▶	Estimated cause(s)▶	Exemplar measures to be taken
The performance is not sufficient for what the motor control characteristics predict.	<ul style="list-style-type: none"> <li>An improper motor constant is being used.</li> </ul>	<ul style="list-style-type: none"> <li>The performance may be improved by automatic tuning. Check "12.3.3 Auto-tune motor."</li> </ul>
Socks occur during the revolutions at the start.	<ul style="list-style-type: none"> <li>The control system has a frequency response that is too high.</li> </ul>	<ul style="list-style-type: none"> <li>Make an adjustment by decrementing the response adjustment [HA115] by 5% each time.</li> <li>Make an adjustment by decrementing the IM motor constant J [Hb118] by 5% each time.</li> </ul>
The motor is hunting.	<ul style="list-style-type: none"> <li>The control system has a frequency response that is too low.</li> </ul>	<ul style="list-style-type: none"> <li>Make an adjustment by incrementing the response adjustment [HA115] by 5% each time.</li> <li>Make an adjustment by incrementing the IM motor constant J [Hb118] by 5% each time.</li> </ul>
Unsteady revolutions at low speeds, resulting in fluctuating revolutions.	<ul style="list-style-type: none"> <li>An improper motor constant is being used.</li> </ul>	<ul style="list-style-type: none"> <li>The performance may be improved by automatic tuning. Check "12.3.3 Auto-tune motor."</li> </ul>
Normal acceleration is impossible and the protection against the over load works.	<ul style="list-style-type: none"> <li>An improper phase sequence is being used.</li> </ul>	<ul style="list-style-type: none"> <li>Set V/f control (00) in [AA121], and check the frequency detection value monitor [dA-08]. The wiring is correct if the forward operation [FW] has a positive (+) value and if the reversal operation [RV] has a negative (-) value. If the forward and negative operations have incorrect values, rearrange the phase sequence in the encoder or check again, "12.9.17 Use encoder."</li> </ul>



- Set the carrier frequency [bb101] at a value of 2.0 kHz or higher. A set frequency of 1.9 kHz or lower may cause an incorrect operation.
- When the revolution of the motor is hindered by breaking or the motor lock caused by foreign objects may cause over current or the like. When no such adjustment as ones mentioned above improves the state, checking the portion around the motor may sometimes improves it.

- If an application of load results in a great amount of change in the inverter's output frequency monitor [dA-01], functions which change automatically change the frequencies for the overload limiting function, the momentary-stop non-stop function, the over voltage suppression function may work depending upon the settings of the functions. For details, see "Chap. 18: Troubleshooting."

### 12.9.12 Control synchronous motor (permanent magnet motor).

Q

- To use the synchronous motor (permanent magnet motor) for saving energy.
- Replace an induction motor with a synchronous motor (permanent magnet motor).

- Things to be noted when conducting the synchronous motor (permanent magnet motor) control

!

- Set an appropriate over current level of the inverter [bb160]. Do not drive a motor whose maximum current (demagnetization level) is below the 150% of [bb160].
    - \* Be aware of the root-mean-square value and the peak value. The rated output current listed in the specification table is the root-mean-square value.
  - This is the control mode for the reducing torque applications where the motor that has the same frame number as the inverter's rating needs a torque at the start that is 50% or smaller. If a certain starting torque is necessary, contact the sales officer of our company.
  - This mode can be used neither in applications that require a constant torque from low speeds nor in applications that involve rapid acceleration or deceleration and that require a large torque from low speeds. Never use this mode for applications involving a gravity load, such as lifts.
  - Synchronous motors (permanent magnet motors) cannot be operated by a direct input from the commercial power supply.
  - Multiple synchronous motors (permanent magnet motors) cannot be driven by a single inverter.
  - Synchronous motors (permanent magnet motors) are more likely to cause over voltage errors than non-synchronous motors (induction motors). If the rapid deceleration and/or the direct-current braking function need to be used, consider the use of an optional braking resistor, a regenerative braking unit, a regenerative power converter.
  - When a hold brake is used, release the brake before the motor starts operation. Otherwise, the motor may lose its synchronism.
  - The motor may move in the reverse direction at the start of its revolution. When a malfunction is caused by the reverse revolution, use the initial-position estimation function [Hd132].
- Controlling a synchronous motor (permanent magnet motor) requires the setting-up of the motor constant. See, "12.3 Basic Settings for Motor." The motor constant is data corresponding to one phase of Y-connection (including wiring).
  - Set the carrier frequency [bb101] at a value of 8.0kHz or higher. Some low carrier frequencies may make the motor generate a lot of heat.
  - The tolerable load moment of inertia is 50 times as large as the motor's moment of inertia or smaller. Some applications whose loads moment of inertia exceed the above mentioned range may result in a performance that is below the desired one.
  - In the case of a long wiring (approximately longer than 20 m) and in the case of controlling motors other than our company's, the performance may be below what are expected from the characteristics.
  - In the case of a long wiring (approximately longer than 20 m), frequency-synchronized re-start may cause an over current error.
  - Driving a motor whose rated current [Hd108] exceeds the inverter's rated current or a motor whose frame number is smaller than the maximum applicable motor by 2 or more may result in a performance that is below the desirable one.
  - Set not only the motor's rated current [Hd108] but also the electronic thermal level [bC110].
  - If the initial position estimation is enabled in the starting method [Hd132], a shrill sound caused by the position detection action may be heard, but this sound has nothing to do with any abnormality.
  - If the initial position estimation is enabled in the starting method [Hd132], start the operation from the state in which the motor stopped. Failure to acquire the correct position may occur, which may result in unintended revolution, over current, or loss of synchronization.

■ Disabled functions



- The following functions cannot be used when the synchronous motor (permanent magnet motor) control is conducted.
- Even when they are enabled by parameters of setting, they are actually disabled.
- In the following table, only the common settings (parameter center "-") and the first settings (parameter center "1") are listed, but it is not possible either to use the second settings (parameter center "2") that correspond to the first settings in the following table.

Item	Parameter	Description
Functions associated with torque control	[FA-15], [FA-16], [dA-15], and [dA-16]	Torque command monitoring function
	[Ad-01] to [Ad-04], and [Ad-40] to [Ad-43], Input terminal 067 [ATR]	Torque controlling function
	[Ad-11] to [Ad-14], Input terminal 068 [TBS]	Torque biasing function
	[bA110] to [bA116], and [bA210] to [bA216], Input terminals 060 [TL], 061 [TRQ1], and 062 [TRQ2] Output terminal 022 [TRQ]	Torque limiting function
	[CE120] to [CE123], Output terminal 019 [OTQ]	Over torque signal
Over current restraining function	[bA120] and [bA121]	Over current restraining function
Functions associated with induction motor control	[HA110]	Stabilization adjustment gain
	[Hb130], [Hb131], [Hb140] to [Hb142], [Hb145], [Hb146], [Hb150] to [Hb163], [Hb170], [Hb171], and [Hb180]	Functions associated with V/f control
	[HC101] and [HC102]	Functions associated with automatic boost
	[HC110] to [HC114], [HC120], and [HC121]	Sensorless vector control, Zero-speed range sensorless vector control
Part of gain mapping function	[HA126],[HA129]	Constant for I control
Part of auto-tuning	[HA-01]=02	Rotating system tuning
	[HA-03]	Online auto-tuning
Commercial power supply switching function	Input terminal 035 [CS]	Switching to commercial power supply
Acceleration or deceleration cancellation function	Input terminal 071 [LAC]	Acceleration or deceleration cancellation function
Jogging Operation	[AG-20], [AG-21], Input Terminals029[JG]	Jogging Operation Function

### ■ Control operation in synchronous start mode

#### A

- In this control mode, operations of magnetic-pole position estimation, synchronous start control, and sensorless vector control are started in this order.
- In the magnetic-pole position estimation, it is possible to select whether the motor is started after the motor's magnetic-pole positions are estimated by use of the initial-position estimation function or the magnetic-pole positions are synchronized by use of the DC braking function.
- In the case of starting after the magnetic-pole position estimation, estimation operation is conducted at the start by setting the start method [Hd132] at 01.
- In the case of the start method [Hd132] being set at 00, the motor is started as its magnetic poles are synchronized with the output phases. In the case where the magnetic poles and the output phases are unsynchronized by a great amount, or in the case that require a certain starting torque, use the starting-time DB to synchronize the magnetic-pole positions and the output phases before the acceleration.
- Use [AF108] to adjust the current during a synchronous starting. Adjustment is possible even when [AF101] = 00. When a larger torque is needed than what is needed in the synchronous starting mode, use of IVMS start mode may improve the situation. Please contact the sales officer of our company.
- The frequency [Hd130] at which the synchronous start control is switched to the sensorless vector control is adjusted at the lowest frequency (switching).
- When a motor is hunting and vibrating, an adjustment of the speed response [HA115] and/or the no-load current [Hd131] may improve the state of the motor.
- When the starting-time DB function is used at the start, see "12.14.2 Start after applying DC braking."

### ■ Parameters for synchronous starting mode

Item	Parameter	Data	Description
Control mode	[AA121]	11	To use synchronous-start type sensorless vector control (SM/PMM)
Speed response	[HA115]	0~1000(%)	To adjust the responsiveness of the control. A larger value enhances the responsiveness.
SM(PMM) lowest frequency (switch)	[Hd130]	0~50(%)	The frequency at which the sensorless vector control is started. Set the ratio to the base frequency [Hd104].
SM(PMM) no-load current	[Hd131]	0~100(%)	Set the ratio of the no-load current to the rated current during the sensorless vector control.
SM(PMM) start method	[Hd132]	00	Initial position estimation is disabled.
		01	Initial position estimation is enabled.
SM(PMM) initial position estimation zero-V stand-by times	[Hd133]	0~255	This is a stand-by adjustment value to stabilize the reference value for the initial position estimation detection.
SM(PMM) initial position estimation detection stand-by times	[Hd134]	0~255	This is an adjustment value to stabilize the current rise of the initial position estimation operation.
SM(PMM) initial position estimation detection times	[Hd135]	0~255	This is a detection-operation adjustment value of the initial position estimation operation.
SM(PMM) initial position estimation voltage gain	[Hd136]	0~200(%)	This is a output-voltage adjustment gain of the initial position estimation operation.
SM(PMM) initial position estimation magnetic-pole position offset	[Hd137]	0~359°	To conduct corrections in a case where the initial position estimation operation has a certain error.
DC braking selection	[AF101]	01	Internal DC braking: enabled
DC braking force at the start	[AF108]	0~100(%)	To adjust the DC braking force. Setting of 100% will provide maximum braking force.
DC braking time at the start	[AF109]	0.0~60.0(s)	Enabled during the internal DC braking. When the operation command is turned ON, DC braking is started.
Over current detection level	[bb160]	Inverter ND rated current × (0.20 to 2.20)	To Set the level at which the over current is detected.

Phenomenon▶	Estimated cause(s)▶	Exemplar measures to be taken
At the start, rotating temporarily in the opposite direction to the intended one.	<ul style="list-style-type: none"> <li>Misalignment of the output phases and the motor's magnetic-pole positions</li> </ul>	<ul style="list-style-type: none"> <li>Enable the initial-position estimation function. [Hd132]=01 In the cases of a slight opposite-direction movement even in the initial-position estimation function, make an adjustment by incrementing [Hd137] by 5° at a time.</li> </ul>
Over current occurs at the start	<ul style="list-style-type: none"> <li>Insufficient starting torque</li> <li>Misalignment of the output phases and the motor's magnetic-pole positions</li> </ul>	<ul style="list-style-type: none"> <li>Enable the initial-position estimation function. [Hd132]=01</li> <li>Set the DC braking at the start [AF101] = 01, and after the start, the time needed for the motor to be stabilized is set in [AF109]. In addition, make an adjustment by incrementing the braking force at the start [AF108] by 5% each time.</li> </ul>
At the start, the motor loses synchronization and no acceleration is observed.	<ul style="list-style-type: none"> <li>Misalignment of the output phases and the motor's magnetic-pole positions</li> </ul>	<ul style="list-style-type: none"> <li>When the magnetic-pole positions are synchronized in the DC braking at the starting, enable the initial-position estimation function instead of the DC braking at the start. [Hd132]=01</li> </ul>
A long starting time is required.	<ul style="list-style-type: none"> <li>A long phase-synchronization time is required.</li> </ul>	<ul style="list-style-type: none"> <li>When the magnetic-pole positions are synchronized in the DC braking at the starting, enable the initial-position estimation function instead of the DC braking at the start. [Hd132]=01</li> </ul>
Fluctuating revolutions occur at low speeds (at the lowest frequency (switch) or even lower)	<ul style="list-style-type: none"> <li>Insufficient starting torque</li> </ul>	<ul style="list-style-type: none"> <li>Make an adjustment by incrementing the braking force at the start [AF108] by 5% each time.</li> </ul>
Hunting occurs at low speeds (at the lowest frequency (switch) or even lower)	<ul style="list-style-type: none"> <li>There is a motor constant error.</li> </ul>	<ul style="list-style-type: none"> <li>Decrement the motor constant R [Hd110] little by little until it reaches a value = set value × 0.7.</li> <li>Increment little by little each of the motor constant Ld [Hd112] and the motor constant Lq [Hd112] until they reach their respective values = set values × 1.4. Note, however that <math>Ld \leq Lq</math>.</li> </ul>
Shock or over current occurs at about the lowest frequency (switch).	<ul style="list-style-type: none"> <li>The speed response is too low.</li> <li>Load fluctuation occurs at around the switch.</li> </ul>	<ul style="list-style-type: none"> <li>Make an adjustment by incrementing the speed response [HA115] by 5% each time.</li> <li>Adjust the lowest frequency (switch) [Hd130].</li> </ul>
Hunting occurs at higher speeds (at the lowest frequency (switch) or higher).	<ul style="list-style-type: none"> <li>Unsynchronized speed response.</li> <li>Distorted wave form of the radio wave.</li> </ul>	<ul style="list-style-type: none"> <li>Make an adjustment by incrementing/decrementing the speed response [HA115] by 5% each time.</li> <li>Make an adjustment by incrementing the no-load current [Hd131] by 5% each time.</li> </ul>
A long initial position estimation time is required.	<ul style="list-style-type: none"> <li>Set value for the estimation is too large.</li> </ul>	<ul style="list-style-type: none"> <li>Lower the values [Hd133] to [Hd135] by the same ratio. * Too low a value may result in an operation in the opposite direction.</li> </ul>
A movement in the opposite direction occurs while the initial position estimation is being used.	<ul style="list-style-type: none"> <li>The estimation is improperly conducted.</li> </ul>	<ul style="list-style-type: none"> <li>Raise the values [Hd133] to [Hd135] by the same ratio, or raise the voltage gain [Hd136] by 5% each time.</li> </ul>
While the initial position estimation is being used, over current errors may occur.	<ul style="list-style-type: none"> <li>Voltage gain is too high.</li> </ul>	<ul style="list-style-type: none"> <li>Decrement the voltage gain [Hd136] by 5% each time.</li> </ul>
Frequency-synchronized re-start may cause errors.	<ul style="list-style-type: none"> <li>Too high revolution speeds and too large offset of the phases.</li> </ul>	<ul style="list-style-type: none"> <li>Make an adjustment by incrementing the speed response [HA115] by 5% each time. Waiting a longer time for the re-start may improve the situation.</li> </ul>



- When the revolution of the motor is hindered by breaking or the motor lock caused by foreign objects may cause over current or the like. When no such adjustment as ones mentioned above improves the state, checking the portion around the motor may sometimes improves it.

- If an application of load results in a great amount of change in the inverter's output frequency monitor [dA-01], functions which change automatically change the frequencies for the overload limiting function, the momentary-stop non-stop function, the over voltage suppression function may work depending upon the settings of the functions. For details, see "Chap. 18: Troubleshooting."

### ■ Control operation in IVMS start mode

**A**

- IVMS start mode is a start mode where larger torque is provided than in the synchronous starting mode.
- When the synchronous starting mode provides an insufficient torque, use of the IVMS start mode may improve the performance.
- Use of the IVMS start mode requires an SM(PMM) constant that is set by the sensorless vector control and an adjustment dedicated for IVMS start mode.
- Before the motor drive, conduct an IVMS auto-tuning and a test run with the load removed.



- Some SM (PMM) may be unable to start in the IVMS start mode.
- IVMS start mode is a control mode that requires a strict adjustment. Please contact the sales officer of our company if your motor cannot start.
- IVMS start mode requires a re-adjustment when the inverter is replaced. When a malfunctioning inverter needs to be restored immediately by replacing the malfunctioning inverter with a new one, the synchronous starting mode should be used.
- As the IVMS start mode is a very special control, which may make a unique operation sound as the starting sound.

### ■ Parameters for IVMS start mode

Item	Parameter	Data	Description
IVMS carrier frequency	[Hd-41]	0.5~16.0(kHz)	Set the carrier frequency during the IVMS drive.
Filter gain of IVMS detection current	[Hd-42]	0~1000	The filter adjustment gain applied to the detection current during the IVMS drive.
Open-phase voltage detection gain selection.	[Hd-43]	00~04	The adjustment gain applied to the detection voltage during the IVMS drive.
Selection of open-phase switch threshold correction.	[Hd-44]	00	IVMS correction: Disabled (no correction)
		01	IVMS correction: Enabled (correction to be conducted)
Speed control P gain	[Hd-45]	0~1000	Speed control P gain during the IVMS drive A larger value enhances the responsiveness of the speed control.
Speed control I gain	[Hd-46]	0~10000	Speed control I gain during the IVMS drive A larger value enhances the responsiveness of the speed control.
Waiting time for open-phase switching	[Hd-47]	0~1000	Waiting time for the open-phase switching during the IVMS drive. A larger value enhances the stability.
Restriction on the rotation-direction determination	[Hd-48]	00	Rotation-direction determination: Disabled (no restriction)
		01	Rotation-direction determination: Enabled (restricted to the operation-command direction)
Adjustment of the timing for detecting the open-phase voltage	[Hd-49]	0~1000	Adjustment value of the IVMS detection timing.
Minimum pulse-width adjustment	[Hd-50]	0~1000	To adjust the width of the voltage pulse during the IVMS drive. A larger value renders the pulse width wider.
Current limit of IVMS threshold	[Hd-51]	0~255	Set a limit on each of the upper and the lower limits of the detection current during the IVMS drive. Enabled when [Hd-44] = 01 (enabled).
IVMS threshold gain	[Hd-52]	0~255	To adjust the IVMS auto-tuning value.
IVMS carrier-frequency switching start/finish point	[Hd-58]	0~50(%)	To adjust the point where the carrier frequency is switched in the IVMS start mode.

## A

- In this control mode, operations of magnetic-pole position estimation, IVMS start control, and sensorless vector control are started in this order.
- In this control mode, only the parameters set by the first set-up are enabled. Terminal [SET] cannot be used.
- In the magnetic-pole position estimation, it is possible to select whether the motor is started after the motor's magnetic-pole positions are estimated by use of the initial-position estimation function or the magnetic-pole positions are synchronized by use of the DC braking function.
- In the case of starting after the magnetic-pole position estimation, estimation operation is conducted at the start by setting the start method [Hd132] at 01.
- In the case of the start method [Hd132] being set at 00, the magnetic poles are positioned to the output phases at the start. As a large offset between the magnetic poles and the output phases may fail the starting, use the starting-time DB to synchronize the magnetic-pole positions and the output phases before the starting.

■ Parameters common to this mode and the synchronous starting mode

Item	Parameter	Data	Description
Control mode	[AA121]	12	To use IVMS-start type sensorless vector control (SM/PMM)
Speed response	[HA115]	0~1000(%)	To adjust the responsiveness of the control. A larger value enhances the responsiveness.
SM(PMM) lowest frequency (switch)	[Hd130]	0~50(%)	The frequency at which the sensorless vector control is started. Set the ratio to the base frequency [Hd104].
SM(PMM) no-load current	[Hd131]	0~100(%)	Set the ratio of the no-load current to the rated current during the sensorless vector control.
SM(PMM) start method	[Hd132]	00	Initial position estimation is disabled.
		01	Initial position estimation is enabled.
SM(PMM) initial position estimation zero-V stand-by times	[Hd133]	0~255	This is a stand-by adjustment value to stabilize the reference value for the initial position estimation detection.
SM(PMM) initial position estimation detection stand-by times	[Hd134]	0~255	This is an adjustment value to stabilize the current rise of the initial position estimation operation.
SM(PMM) initial position estimation detection times	[Hd135]	0~255	This is a detection-operation adjustment value of the initial position estimation operation.
SM(PMM) initial position estimation voltage gain	[Hd136]	0~200(%)	This is a output-voltage adjustment gain of the initial position estimation operation.
SM(PMM) initial position estimation magnetic-pole position offset	[Hd137]	0~359(°)	To conduct corrections in a case where the initial position estimation operation has a certain error.
DC braking selection	[AF101]	01	Internal DC braking: enabled
DC braking force at the start	[AF108]	0~100(%)	To adjust the DC braking force. Setting of 100% will provide maximum braking force.
DC braking time at the start	[AF109]	0.0~60.0(s)	Enabled during the internal DC braking. When the operation command is turned ON, DC braking is started.
Over current detection level	[bb160]	Inverter ND rated current × (0.20 to 2.20)	To Set the level at which the over current is detected.



■ Set-up procedures of IVMS start mode



1

Set the protection for the PM motor.

- Setting the over current detection level [bb160]
- Setting the electronic thermal level [bc110]



2

Set the PM motor's Plate Data.

- Setting the capacitance [Hd102]
- Setting the number of poles [Hd103]
- Setting the base frequency [Hd104]
- Setting the maximum frequency [Hd105]
- Setting the rated voltage [Hd106]
- Setting the rated current [Hd108]



3

Set the PM motor constants.

- Setting the motor constant R [Hd110].
- Setting the motor constant Ld [Hd112].
- Setting the motor constant Lq [Hd114].
- Setting the motor constant Ke [Hd116].
- Setting the motor constant J [Hd118].



4

Conduct the IVMS auto-tuning

- Set the control mode [AA121] at 12 (SM-IVMS).
- Set the auto-tuning selection [HA-01] at 03 (IVMS).
- Input the command for starting the auto-tuning (operation command).
- The inverter is in an automatic operation.
- Tuning is finished.



- The over-current detection level should be set appropriately by taking into account the maximum current (demagnetization level) of the PM motor to be used. Set the over-current detection level so that the SM (PMM)'s maximum current (demagnetization level) is not below 150% of the over-current detection level.
- See also "12.7.1 Conduct the electronic thermal protection on motors," and set it appropriately
- See also "12.3.1 Set plate data of motor as parameters," and set them appropriately.
- See also "12.3.2 Set Motor Constants" and set them appropriately.
- For the procedures from the auto-tuning start to the auto-tuning finish, check "12.3.3 Auto-tune motor," and follow the procedures.
- In the IVMS auto-tuning, the tuning should be done as the motor shaft is being rotated little by little. When the motor shaft is locked, or when the load is heavy, even a normal finish of the auto-tuning may result in a adjustment failure. Conduct the IVMS auto-tuning with nothing attached to the motor shaft.
- When an over current occurs during the automatic operation of the IVMS auto-tuning, check the following items.
  - (1) Motor lock caused by braking and/or foreign objects.
  - (2) Setting over-current detection level [bb160] Check these items, and when there is no problem, conduct the IVMS auto-tuning by incrementing the minimum pulse width adjustment [Hd-50] by 10 each time.
- It may take approximately 5 minute to conduct the IVMS auto-tuning.

**5**

## Run test running

- Set the main-speed command [FA-01] at a value that is smaller than the lowest frequency (switch) [Hd130], and check that stable drive can be provided for the forward revolutions, the backward revolutions, the acceleration, and the deceleration.
- Then, Set the main-speed command [FA-01] at a value that is larger than the lowest frequency (switch) [Hd130], and check that stable drive can be provided for the forward revolutions, the backward revolutions, the acceleration, and the deceleration.



- When the adjustment has been conducted repeatedly but no trial operation can be conducted, it may be due to the unavailability of IVMS start mode for use. Use the synchronous starting mode, or please contact the sales officer of our company.

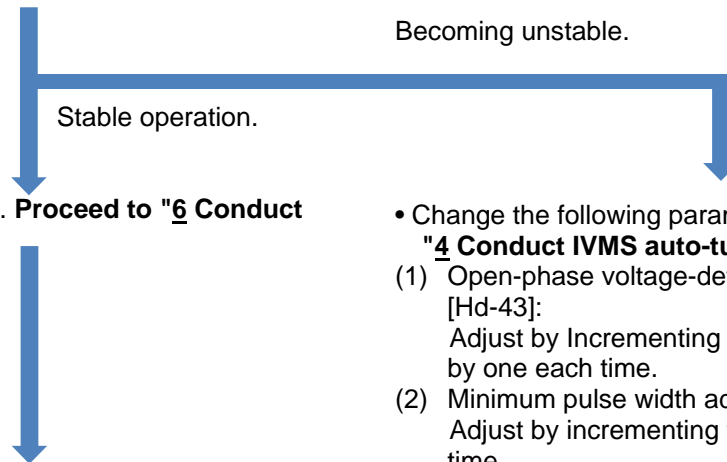

- Finish the test running. **Proceed to "6 Conduct real operation."**

- Change the following parameter settings re-conduct "**4 Conduct IVMS auto-tuning**".
  - (1) Open-phase voltage-detection gain selection [Hd-43]:  
Adjust by incrementing the value from 00 to 03 by one each time.
  - (2) Minimum pulse width adjustment [Hd-50]:  
Adjust by incrementing the value by 10 each time.

**6**

## Conduct real operation

- Combine the target motor with a load device that you want to drive actually and then start the operation, and then check whether the motor can provide a stable drive. • The drive performance may be improved by conducting a parameter adjustment. For more details, see the following.
- For the adjustment of the high-speed (lowest frequency (switch) or higher), see also the descriptions of the synchronous starting mode.



- During the real operation, do not change the following parameters set in **4 "conduct the IVMS auto-tuning,"** and **"5 Conduct a trial operation."** Such change may destabilize the operations.
- Open-phase voltage-detection gain selection [Hd-43]
- Minimum pulse width adjustment [Hd-50]

■ Not successful

Phenomenon▶	Estimated cause(s)▶	Exemplar measures to be taken
Over current occurs at the start	<ul style="list-style-type: none"> <li>• Insufficient starting torque</li> <li>▶ Misalignment of the output phases and the motor's magnetic-pole positions</li> </ul>	<ul style="list-style-type: none"> <li>• Enable the selection of open-phase switch threshold correction [Hd-44].</li> <li>• Adjust each of the speed control P gain [Hd-45] and the speed control I gain [Hd-46] by 10 each time. The adjustment should be conducted so that [Hd-45] ≤ [Hd-46]. Some motor characteristics require an adjustment by raising and lowering the settings.</li> <li>• Adjust the waiting time for open-phase switching [Hd-47] by incrementing it by 5 each time. Some motor characteristics require an adjustment by raising and lowering the settings.</li> </ul>
At the start, the motor loses synchronization and no acceleration is observed.	<ul style="list-style-type: none"> <li>• Insufficient starting torque</li> <li>▶ Misalignment of the output phases and the motor's magnetic-pole positions</li> </ul>	<ul style="list-style-type: none"> <li>• Enable the selection of open-phase switch threshold correction [Hd-44].</li> <li>• Adjust each of the speed control P gain [Hd-45] and the speed control I gain [Hd-46] by 10 each time. The adjustment should be conducted so that [Hd-45] ≤ [Hd-46]. Some motor characteristics require an adjustment by raising and lowering the settings.</li> <li>• Adjust the waiting time for open-phase switching [Hd-47] by incrementing it by 5 each time. Some motor characteristics require an adjustment by raising and lowering the settings.</li> </ul>
Loss of synchronization, hunting, and/or over current occur at low speeds (at the lowest frequency(switch) or even lower).	<ul style="list-style-type: none"> <li>• Insufficient torque</li> <li>• Misalignment of the output phases and the motor's magnetic-pole positions</li> </ul>	<ul style="list-style-type: none"> <li>• Enable the selection of open-phase switch threshold correction [Hd-44].</li> <li>• Adjust each of the speed control P gain [Hd-45] and the speed control I gain [Hd-46] by 10 each time. The adjustment should be conducted so that [Hd-45] ≤ [Hd-46]. Some motor characteristics require an adjustment by raising and lowering the settings.</li> <li>• Adjust the waiting time for open-phase switching [Hd-47] by incrementing it by 5 each time. Some motor characteristics require an adjustment by raising and lowering the settings.</li> </ul>
Loss of synchronization, hunting, and/or over current occur at low speeds (at the lowest frequency(switch) or even lower) and with a heavy load.	<ul style="list-style-type: none"> <li>• Insufficient torque</li> <li>• Misalignment of the output phases and the motor's magnetic-pole positions</li> </ul>	<ul style="list-style-type: none"> <li>• Adjust by decrementing the current limit of IVMS threshold [Hd-51] by 5 each time. Some motor characteristics may provide instability with excessively small settings.</li> <li>• Adjust by decrementing the IVMS threshold gain [Hd-52] by 5 each time. Some motor characteristics require an adjustment by raising and lowering the settings.</li> </ul>
The drive becomes unstable at low speeds (at the lowest frequency(switch) or even lower)	<ul style="list-style-type: none"> <li>• Misalignment of the output phases and the motor's magnetic-pole positions</li> </ul>	<ul style="list-style-type: none"> <li>• Adjust by decrementing the IVMS detection current filter gain [Hd-42] by 5 each time. Some motor characteristics require an adjustment by raising and lowering the settings.</li> <li>• Adjust the waiting time for open-phase switching [Hd-47] by incrementing it by 5 each time. Some motor characteristics require an adjustment by raising and lowering the settings.</li> </ul>



- When the above-described procedures fail to allow successful adjustment, special adjustment may be necessary. Please contact the sales officer of our company.

**12.9.13** Use V/f control with sensor  
(constant torque characteristics)

**Q**

- To conduct a V/f control with a high revolution accuracy by use of the revolution-speed feedback of a motor.
- To make the motor follow the command frequency accurately for the purpose of calculating the turns or the like.

**A**

- The feedback of the encoder signal from the motor allows highly accurate frequency control.
- For the adjustment of V/f control (constant torque characteristics), see "12.9.2 Drive with V/f control (constant torque characteristics)."



- When [CA-90] = 02, Input terminals [A] and [B] are switched to the terminals for feedback control. When [CA-90] ≠ 02, terminals [EA] and [EB] of the feedback option P1-FB are enabled. See "12.9.17 Use encoder."
- In the V/f control with feedback (FB), a correction of PI control is conducted on the command frequency for the fed-back frequency to control the motor.

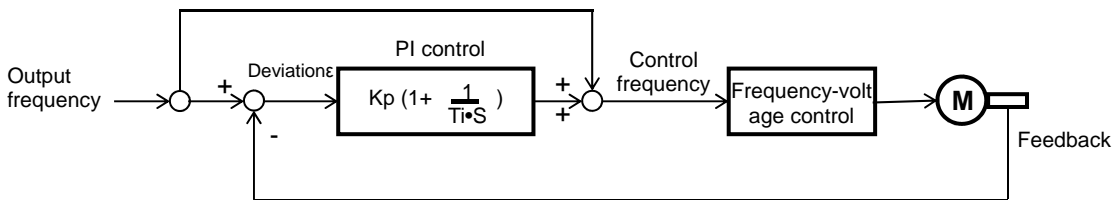

Kp: proportional gain setting; Ti: integral time; s: operator; ε: deviation  
Ki: integral gain setting (Ki = Ti/Kp)

■ Parameter

Item	Parameter	Data	Description
Control mode	[AA121]	04	To use V/f control with sensor (constant torque characteristics).
Control with sensor slip compensation P gain	[Hb170]	0~1000(%)	This is the P gain for the slip compensation of control with sensor.
Control with sensor slip compensation I gain	[Hb171]	0~1000(%)	This is the I gain for the slip compensation of control with sensor.



- Please refer to the following in addition to the notes for each control mode.

Phenomenon▶	Estimated cause(s)▶	Exemplar measures to be taken
<ul style="list-style-type: none"> <li>• The motor speed follows the command slowly.</li> </ul>	<ul style="list-style-type: none"> <li>• Response of the output is slow and the change in the fed-back value is slow.</li> </ul>	<ul style="list-style-type: none"> <li>• Increment the proportional (P) gain [Hb170].</li> </ul>
<ul style="list-style-type: none"> <li>• The motor operates unstably.</li> <li>• Overshoot and/or hunting occur.</li> </ul>	<ul style="list-style-type: none"> <li>• Response to the fed-back value is too quick.</li> </ul>	<ul style="list-style-type: none"> <li>• Decrement the proportional (P) gain [Hb170].</li> </ul>
<ul style="list-style-type: none"> <li>• The motor speed oscillates gently.</li> <li>• Stabilization of the operation requires a long time.</li> </ul>	<ul style="list-style-type: none"> <li>• Response to the integral operation is slow.</li> </ul>	<ul style="list-style-type: none"> <li>• Increment the integral (I) gain [Hb171].</li> </ul>
<ul style="list-style-type: none"> <li>• It takes time for the command value and the motor speed to be equal to each other.</li> </ul>	<ul style="list-style-type: none"> <li>• Response of the output is slow and the change in the fed-back value is slow.</li> </ul>	<ul style="list-style-type: none"> <li>• Decrement the integral (I) gain [Hb171].</li> </ul>



- When the revolution of the motor is hindered by breaking or the motor lock caused by foreign objects may cause over current or the like. When no such adjustment as ones mentioned above improves the state, checking the portion around the motor may sometimes improves it.
- If an application of load results in a great amount of change in the inverter's output frequency monitor [dA-01], functions which change frequencies automatically, such as overload limiting function, non-stop at momentary-stop, and over voltage suppression function may work depending upon the settings of the functions. For details, see "Chap. 18: Troubleshooting."

**12.9.14** Use V/f control with sensor (reducing torque characteristics)

**Q**

- To conduct a V/f control with a high revolution accuracy by use of the revolution-speed feedback of a motor.
- To output the revolutions of fans and/or pumps exactly in accordance with their respective speed characteristics.

**A**

- The feedback of the encoder signal from the motor allows highly accurate frequency control.
- For the adjustment of V/f control (reducing torque characteristics), see "12.9.3 Drive with V/f control (reducing torque characteristics)."

**!**

- When [CA-90] = 02, Input terminals [A] and [B] are switched to the terminals for feedback control. When [CA-90] ≠ 02, terminals [EA] and [EB] of the feedback option P1-FB are enabled. See "12.9.17 Use encoder."
- In the V/f control with feedback (FB), a correction of PI control is conducted on the command frequency for the fed-back frequency to control the motor.

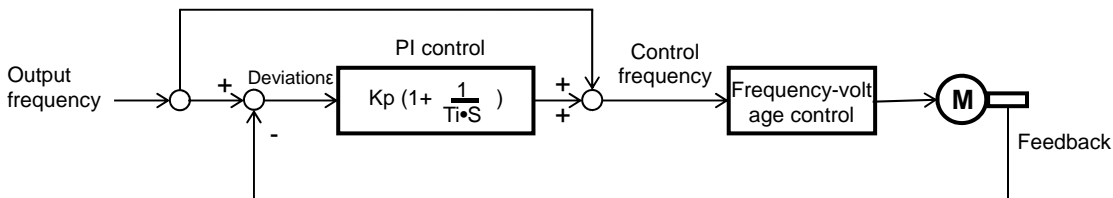

Kp: proportional gain setting; Ti: integral time; s: operator; ε: deviation  
 Ki: integral gain setting (Ki = Ti/Kp)

■ Parameter

Item	Parameter	Data	Description
Control mode	[AA121]	05	To use V/f control with sensor (reducing torque characteristics).
Control with sensor slip compensation P gain	[Hb170]	0~1000(%)	This is the P gain for the slip compensation of control with sensor.
Control with sensor slip compensation I gain	[Hb171]	0~1000(%)	This is the I gain for the slip compensation of control with sensor.



- Please refer to the following in addition to the notes for each control mode.

Phenomenon▶	Estimated cause(s)▶	Exemplar measures to be taken
<ul style="list-style-type: none"> <li>• The motor speed follows the command slowly.</li> </ul>	<ul style="list-style-type: none"> <li>• Response of the output is slow and the change in the fed-back value is slow.</li> </ul>	<ul style="list-style-type: none"> <li>• Increment the proportional (P) gain [Hb170].</li> </ul>
<ul style="list-style-type: none"> <li>• The motor operates unstably.</li> </ul>	<ul style="list-style-type: none"> <li>• Response to the fed-back value is too quick.</li> </ul>	<ul style="list-style-type: none"> <li>• Decrement the proportional (P) gain [Hb170].</li> </ul>
<ul style="list-style-type: none"> <li>• Overshoot and/or hunting occur.</li> </ul>		
<ul style="list-style-type: none"> <li>• The motor speed oscillates gently.</li> </ul>	<ul style="list-style-type: none"> <li>• Response to the integral operation is slow.</li> </ul>	<ul style="list-style-type: none"> <li>• Increment the integral (I) gain [Hb171].</li> </ul>
<ul style="list-style-type: none"> <li>• Stabilization of the operation requires a long time.</li> </ul>		
<ul style="list-style-type: none"> <li>• It takes time for the command value and the motor speed to be equal to each other.</li> </ul>	<ul style="list-style-type: none"> <li>• Response of the output is slow and the change in the fed-back value is slow.</li> </ul>	<ul style="list-style-type: none"> <li>• Decrement the integral (I) gain [Hb171].</li> </ul>



- When the revolution of the motor is hindered by breaking or the motor lock caused by foreign objects may cause over current or the like. When no such adjustment as ones mentioned above improves the state, checking the portion around the motor may sometimes improves it.
- If an application of load results in a great amount of change in the inverter's output frequency monitor [dA-01], functions which change frequencies automatically, such as overload limiting function, non-stop at momentary-stop, and over voltage suppression function may work depending upon the settings of the functions. For details, see "Chap. 18: Troubleshooting."

**12.9.15** Use free V/f control with sensor

**Q**

- To conduct a V/f control with a high revolution accuracy by use of the revolution-speed feedback of a motor.
- To control the speed of high-speed motors

**A**

- The feedback of the encoder signal from the motor allows highly accurate frequency control.
- For the adjustment of V/f control (free V/f), see "12.9.4 Drive with V/f control (free V/f)."

**!**

- When [CA-90] = 02, Input terminals [A] and [B] are switched to the terminals for feedback control. When [CA-90] ≠ 02, terminals [EA] and [EB] of the feedback option P1-FB are enabled. See "12.9.17 Use encoder."
- In the V/f control with feedback (FB), a correction of PI control is conducted on the command frequency for the fed-back frequency to control the motor.

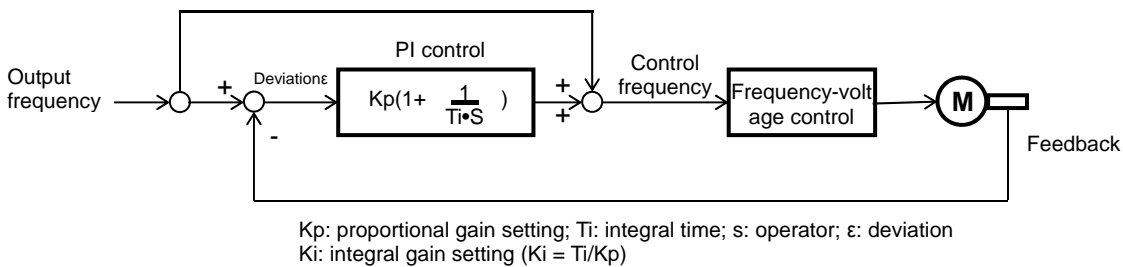

**Parameter**

Item	Parameter	Data	Description
Control mode	[AA121]	06	To use V/f control with sensor (free V/f).
Control with sensor slip compensation P gain	[Hb170]	0~1000(%)	This is the P gain for the slip compensation of control with sensor.
Control with sensor slip compensation I gain	[Hb171]	0~1000(%)	This is the I gain for the slip compensation of control with sensor.





- Please refer to the following in addition to the notes for each control mode.

Phenomenon▶	Estimated cause(s)▶	Exemplar measures to be taken
<ul style="list-style-type: none"> <li>• The motor speed follows the command slowly.</li> </ul>	<ul style="list-style-type: none"> <li>• Response of the output is slow and the change in the fed-back value is slow.</li> </ul>	<ul style="list-style-type: none"> <li>• Increment the proportional (P) gain [Hb170].</li> </ul>
<ul style="list-style-type: none"> <li>• The motor operates unstably.</li> <li>• Overshoot and/or hunting occur.</li> </ul>	<ul style="list-style-type: none"> <li>• Response to the fed-back value is too quick.</li> </ul>	<ul style="list-style-type: none"> <li>• Decrement the proportional (P) gain [Hb170].</li> </ul>
<ul style="list-style-type: none"> <li>• The motor speed oscillates gently.</li> <li>• Stabilization of the operation requires a long time</li> </ul>	<ul style="list-style-type: none"> <li>• Response to the integral operation is slow.</li> </ul>	<ul style="list-style-type: none"> <li>• Increment the integral (I) gain [Hb171].</li> </ul>
<ul style="list-style-type: none"> <li>• It takes time for the command value and the motor speed to be equal to each other.</li> </ul>	<ul style="list-style-type: none"> <li>• Response of the output is slow and the change in the fed-back value is slow.</li> </ul>	<ul style="list-style-type: none"> <li>• Decrement the integral (I) gain [Hb171].</li> </ul>



- When the revolution of the motor is hindered by breaking or the motor lock caused by foreign objects may cause over current or the like. When no such adjustment as ones mentioned above improves the state, checking the portion around the motor may sometimes improves it.
- If an application of load results in a great amount of change in the inverter's output frequency monitor [dA-01], a functions which change frequencies automatically, such as overload limiting function, non-stop at momentary-stop, and over voltage suppression function may work depending upon the settings of the functions. For details, see "Chap. 18: Troubleshooting."

**12.9.16** Use automatic boost function with sensor



- To conduct a V/f control with a high revolution accuracy by use of the revolution-speed feedback of a motor.
- To make the motor follow the command frequency accurately in applications that require a certain torque.



- The feedback of the encoder signal from the motor allows highly accurate frequency control.
- For the adjustment of the automatic boost control, see, "12.9.7 Automatically adjust torque."



- When [CA-90] = 02, Input terminals [A] and [B] are switched to the terminals for feedback control. When [CA-90] ≠ 02, terminals [EA] and [EB] of the feedback option P1-FB are enabled. See "12.9.17 Use encoder."
- In the V/f control with feedback (FB), a correction of PI control is conducted on the command frequency for the fed-back frequency to control the motor.

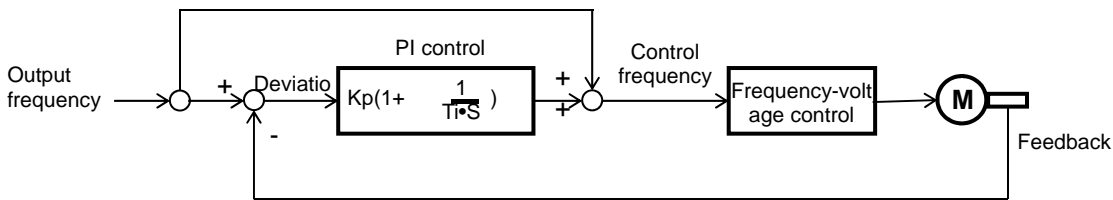

Kp: proportional gain setting; Ti: integral time; s: operator; ε: deviation  
 Ki: integral gain setting (Ki = Ti/Kp)

■ Parameter

Item	Parameter	Data	Description
Control mode	[AA121]	07	To use the automatic torque boost with sensor.
Control with sensor slip compensation P gain	[Hb170]	0~1000(%)	This is the P gain for the slip compensation of control with sensor.
Control with sensor slip compensation I gain	[Hb171]	0~1000(%)	This is the I gain for the slip compensation of control with sensor.



- Please refer to the following in addition to the notes for each control mode.

Phenomenon▶	Estimated cause(s)▶	Exemplar measures to be taken
<ul style="list-style-type: none"> <li>• The motor speed follows the command slowly.</li> </ul>	<ul style="list-style-type: none"> <li>• Response of the output is slow and the change in the fed-back value is slow.</li> </ul>	<ul style="list-style-type: none"> <li>• Increment the proportional (P) gain [Hb170].</li> </ul>
<ul style="list-style-type: none"> <li>• The motor operates unstably.</li> <li>• Overshoot and/or hunting occur.</li> </ul>	<ul style="list-style-type: none"> <li>• Response to the fed-back value is too quick.</li> </ul>	<ul style="list-style-type: none"> <li>• Decrement the proportional (P) gain [Hb170].</li> </ul>
<ul style="list-style-type: none"> <li>• The motor speed oscillates gently.</li> <li>• Stabilization of the operation requires a long time.</li> </ul>	<ul style="list-style-type: none"> <li>• Response to the integral operation is slow.</li> </ul>	<ul style="list-style-type: none"> <li>• Increment the integral (I) gain [Hb171].</li> </ul>
<ul style="list-style-type: none"> <li>• It takes time for the command value and the motor speed to be equal to each other.</li> </ul>	<ul style="list-style-type: none"> <li>• Response of the output is slow and the change in the fed-back value is slow.</li> </ul>	<ul style="list-style-type: none"> <li>• Decrement the integral (I) gain [Hb171].</li> </ul>



- When the revolution of the motor is hindered by breaking or the motor lock caused by foreign objects may cause over current or the like. When no such adjustment as ones mentioned above improves the state, checking the portion around the motor may sometimes improves it.
- If an application of load results in a great amount of change in the inverter's output frequency monitor [dA-01], functions which change frequencies automatically, such as overload limiting function, non-stop at momentary-stop, and over voltage suppression function may work depending upon the settings of the functions. For details, see "Chap. 18: Troubleshooting."

## 12.9.17 Use encoder



- To set up the encoder when the revolution-speed feedback of a motor is used.



- In SJ-P1, the control with sensor and the absolute position control can be conducted by inputting the feedback from the motor into the controller circuit terminal table of the main body or into the feedback option P1-FB.



- When [CA-90] ≠ 00, Input terminals [A] and [B] of the main body are switched to the terminals for feedback control.
- When [CA-90] = 02, the control with sensor and the absolute position control are possible with Input terminals [A] and [B].
- When [CA-90] ≠ 02, the control with sensor and the absolute position control are possible with terminals [EAP], [EBP], [EAN], and [EBN] of the feedback option P1-FB.
- To conduct the pulse train position control, terminals [SAP], [SBP], [SAN], and [SBN] of the feedback option P1-FB are used.
- When the feedback option P1-FB was once set in a slot and was removed later, a trip occurs with a feedback option connection error [E112].
- Trips are triggered by an encoder disconnection error [E100] by setting switches on the feedback option P1-FB. For more details, see the instruction manual of P1-FB.

## ■ Parameter

Item	Parameter	Data	Description
Encoder constant set-up	[CA-81]	0~65535(pls)	Setting the encoder constant
Encoder phase sequence selection	[CA-82]	00	Phase-A is leading.
		01	Phase-B is leading.
Motor gear ratio's numerator	[CA-83]	1~10000	Setting the numerator of the gear ratio of a motor.
Motor gear ratio's denominator	[CA-84]	1~10000	Setting the denominator of the gear ratio of a motor.
Pulse train input (main body) detection target selection	[CA-90]	00	PCNT function
		01	Command
		02	Control with speed feedback
		03	Pulse count
Pulse train input (main body) mode selection	[CA-91]	00	MD0: 90-degree phase difference pulse train
		01	MD1: Forward-backward rotation command + pulse train
		02	MD2: Forward-rotation pulse train + backward-rotation pulse train.
Encoder constant set-up (P1-FB)	[ob-01]	0~65535(pls)	Setting the encoder constant
Encoder phase sequence selection (P1-FB)	[ob-02]	00	Phase-A is leading.
		01	Phase-B is leading.
Motor gear ratio's numerator (P1-FB)	[ob-03]	1~10000	Setting the numerator of the gear ratio of a motor.
Motor gear ratio's denominator (P1-FB)	[ob-04]	1~10000	Setting the denominator of the gear ratio of a motor.
Pulse train input SA/SB (P1-FB) detection target selection	[ob-10]	00	Command
		01	Pulse train position command
Pulse train input SA/SB (P1-FB) mode selection	[ob-11]	00	MD0: 90-degree phase difference pulse train
		01	MD1: Forward-backward rotation command + pulse train
		02	MD2: Forward-rotation pulse train + backward-rotation pulse train.

Encoder's setting table

	Setting description	Terminals [A] and [B] of main body	terminals [EAP], [EBP], [EAN], and [EBN] of P1-FB.
(1)	Encoder constant set-up	[CA-81]	[ob-01]
(2)	Encoder phase-sequence selection	[CA-82]	[ob-02]
(3)	Encoder gear ratio's numerator	[CA-83]	[ob-03]
(4)	Encoder's gear ratio's denominator	[CA-84]	[ob-04]

**A**

- Table (1)Encoder constant-setup sets up the actual number of pulses of the encoder based on the terminals to be used.
- Table (2) encoder phase sequence selection is set up in accordance with the encoder's phase sequence.
- When [CA-90] = 02, the main-body speed feedback is enabled while [CA-90] ≠ 02, P1-FB speed feedback is enabled.

Adjustment in cases where a gear exists between the motor and the encoder.

**A**

- When the encoder and the motor shaft are connected to each other by means of a gear, for Tables (3) and (4) conversion is made possible by setting up (3) Encoder gear-ratio's numerator/(4) encoder gear-ratio's denominator.
- Set the values ((3)/(4)) so as to be within a range between (1/50) to (20).
- An exemplar case where a gear is attached there.

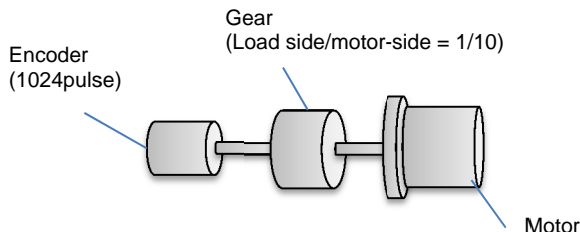

When the encoder's rotating rate for the motor's standard encoder becomes 1/10 for 1024 pulses,  
 Table (1) Encoder constant set-up: 1024 pulses  
 Table (3): Encoder's gear ratio's numerator: 1.  
 Table (4): Encoder's gear ratio's denominator: 10  
 Set up as above.

**!**

- When either [CA-82] or [ob-02] = 00, meaning that phase-A is leading, and when the operation is of forward rotation, the phase of the phase-A advances 90-degrees more than that of the phase-B in a normal case.
- When either [CA-82] or [ob-02] = 01, meaning that phase-B is leading, and when the operation is of forward rotation, the phase of the phase-B advances 90-degrees more than that of the phase-A in a normal case.
- To check if the encoder input into the main body or into P1-FB is correct, set [AA121] = 00, meaning V/f control (00), and check the monitor for the [dA-08] frequency detection values. The wiring is correct if the forward operation [FW] has a positive (+) value and if the reversal operation [RV] has a negative (-) value. If it is incorrect, either revising the wiring or switching the corresponding encoder phase sequence selection [CA-82] or [ob-02].

Encoder's speed detection

**A**

- To acquire the frequency that was input through the encoder, the following settings are necessary.
  - Set-up of Tables (1), (3), and (4)
  - Set-up of the number of motor poles
  - \* When the selected control mode [AA121] is the induction motor control ([AA121] = 00 to 10), IM motor's number of motor poles [Hb103] is set as the number of motor poles.

■ Set-up of functions of the encoder feedback.



**1** Check the encoder's set-up from the encoder's specifications.

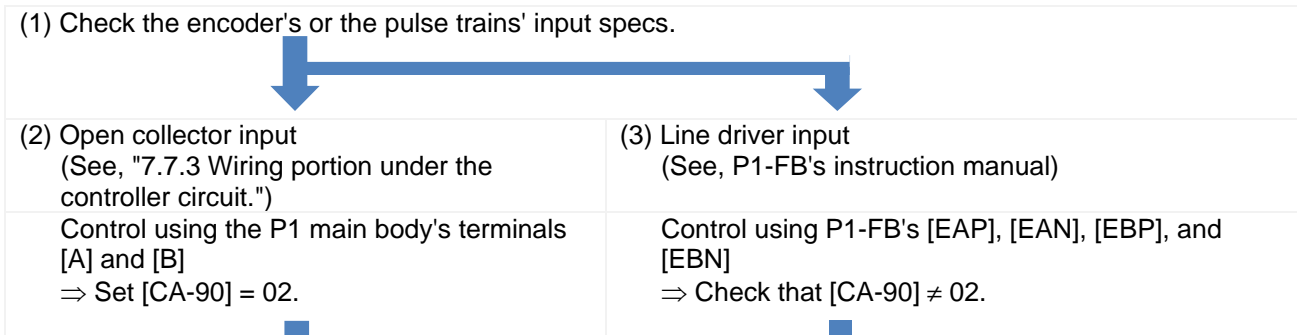

**2** Set up the control method.

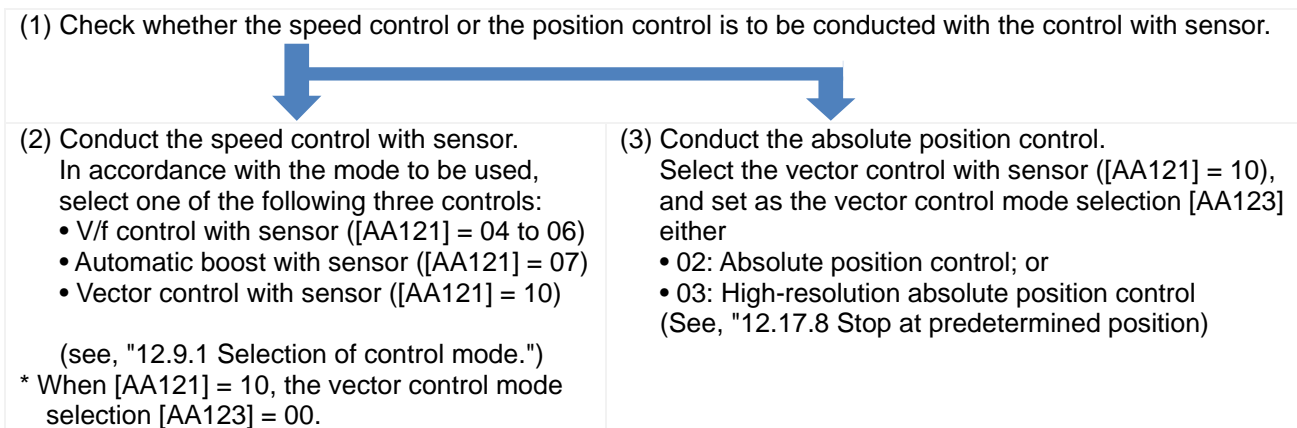

### 12.9.18 Check the set-up for the pulse train input.



- To check the related settings when either the encoder or the pulse generator is input.



- The following table lists a function where a function of inputting the related pulse train into the main body's terminals [A] and [B], and into the P1-FB's terminals: [EAP], [EAN], [EBP], [EBN], [SAP], [SAN], [SBP], and [SBN].

Function to be used	Setting check	For pulse-train input
Speed control with sensor	Necessary settings <ul style="list-style-type: none"> <li>Control with sensor ([AA121] = 04 to 07) or</li> <li>Vector control with sensor ([AA121] = 10 and [AA123] = 00)</li> <li>Selection of target for pulse train input detection ([CA-90], See the right-hand side.)</li> </ul> Related section "12.9 Select motor control method in accordance with motor and load"	
Speed-torque control with sensor	Necessary settings <ul style="list-style-type: none"> <li>Vector control with sensor ([AA121] = 10 and [AA123] = 00)</li> <li>Selection of target for pulse train input detection ([CA-90], See the right-hand side.)</li> </ul> Related section "12.9.11 Use vector control with sensor" "12.11 Control torque in accordance with load"	<ul style="list-style-type: none"> <li>Input into P1 main body's terminals [A] and [B] ([CA-90] = 02)</li> <li>Input into P1-FB's terminals [EAP], [EAN], [EBP], and [EBN] ([CA-90] ≠ 02).</li> </ul>
Absolute position control	Necessary settings <ul style="list-style-type: none"> <li>Vector control with sensor ([AA121] = 10 and [AA123] = 02, or [AA121] = 10 and [AA123] = 03)</li> <li>Selection of target for pulse train input detection ([CA-90], See the right-hand side.)</li> </ul> Related section "12.9.11 Use vector control with sensor" "12.17.9 Control in the origin-based absolute position"	
Pulse train position control	Necessary settings <ul style="list-style-type: none"> <li>Vector control with sensor ([AA121] = 10 and [AA123] = 01)</li> <li>Pulse train input SA/SB ([ob-10] = 01)</li> </ul> Related section "12.17.7 Conduct pulse train position control"	<ul style="list-style-type: none"> <li>To input P1-FB's terminals [SAP], [SAN], [SBP], and [SBN].</li> </ul> The following items can be used for the motor's vector control. <ul style="list-style-type: none"> <li>Input into P1 main body's terminals [A] and [B] ([CA-90] = 02)</li> <li>Input into P1-FB's terminals [EAP], [EAN], [EBP], and [EBN] ([CA-90] ≠ 02).</li> </ul>
Pulse train frequency command (main body)	Necessary settings <ul style="list-style-type: none"> <li>Frequency command ([AA101] = 12)</li> <li>Selection of target for pulse train input detection ([CA-90] = 01)</li> </ul> Related section "12.4.6 Make pulse train input command."	<ul style="list-style-type: none"> <li>Input into P1 main body's terminals [A] and [B].</li> </ul>
Pulse train frequency command (P1-FB)	Necessary settings <ul style="list-style-type: none"> <li>Frequency command ([AA101] = 13)</li> <li>Pulse train input SA/SB ([ob-10] = 00)</li> </ul> Related section "12.4.6 Make pulse train input command."	<ul style="list-style-type: none"> <li>To input P1-FB's terminals [SAP], [SAN], [SBP], and [SBN].</li> </ul>
Pulse count	Necessary settings <ul style="list-style-type: none"> <li>Selection of target for pulse train input detection ([CA-90] = 03)</li> </ul> Related section "12.24.6 Check number of input pulses."	<ul style="list-style-type: none"> <li>Input into P1 main body's terminals [A] and [B].</li> </ul>

## 12.10 Process Control Conforming to the System

### 12.10.1 Use PID Control

**Q**

- We want to perform process-control for flow rate, air flow, pressure and others.
- We want to switch PID control and normal control.
- We want to set soft-start for prevention of water hammer of the pump.
- We want to conserve energy by stopping the motor when the flow rate, air flow, pressure and others exceed a certain output.

**A**

- SJ-P1 is equipped with 4 independent PID functions, and each PID can be set independently.
  - Four PID functions can be used for motor control by switching the [PIO1]/[PIO2] terminals.
  - PID not used for motor control can be used for operation of exterior PID not related to inverter control freely.
- This helps to save space and cost because there is no need to install a separate PID controller.
- PID1 can be controlled based on 3 deviations.
  - Connecting PID1 and PID2 can make 2-layer PID control possible.

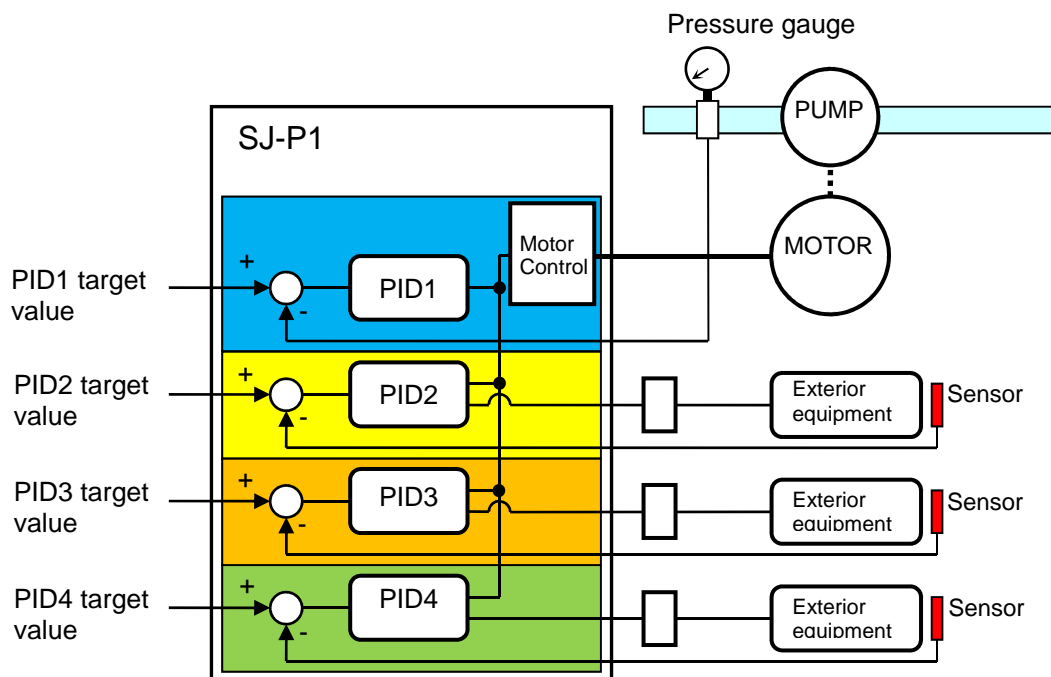



**A**

- For PID control, you can select feed-forward control to attempt stabilizing disturbance in advance, in addition to feedback control to stabilize disturbance.
- To control output frequency sent to the motor by the PID function, selection of PID1-4 and setting of frequency command are required.
- In the soft-start function, operating normally for a certain period of distance at the start can raise output automatically and then shift to PID control. See "12.10.5 PID Soft-Start Function".
- Sleep mode operation, which is more energy saving, can be set for when the flow rate or air volume is increased. See "12.10.6 PID Sleep Condition Selection Function".
- During PID operation, PID functions are disabled and normal output is performed with the command selected as a target value, while the input terminal function [PID] signal is ON.
- Multi-layer command by PID control command is feasible.

**!**

- In the case of controlling the motor by PID control, frequency command destination needs to be set to PID output.
- The upper/lower limiter function operates for command frequency by PID output. It does not operate for PID target value.

**▼**

e.g.) Follow the steps below to perform simple PID control by inputting a target value [Ai1] and a feedback (FB) value [Ai2] from where parameters are default.

- [1] Set [AH-01] to 01 (enable)
- [2] Set 15 (PID calculation) to the main speed command selection [AA101]
- [3] Set 01 (Ai1) to the PID1 target value 1 input destination [AH-07]
- [4] Set 02 (Ai2) to the PID1 FB 1 input destination [AH-07]
- [5] Set the PID gain of PID1 to [AH-61] to [AH-63]
- [6] Put the command set to operation command selection [AA111] and start PID control

■ Basic composition of PID control

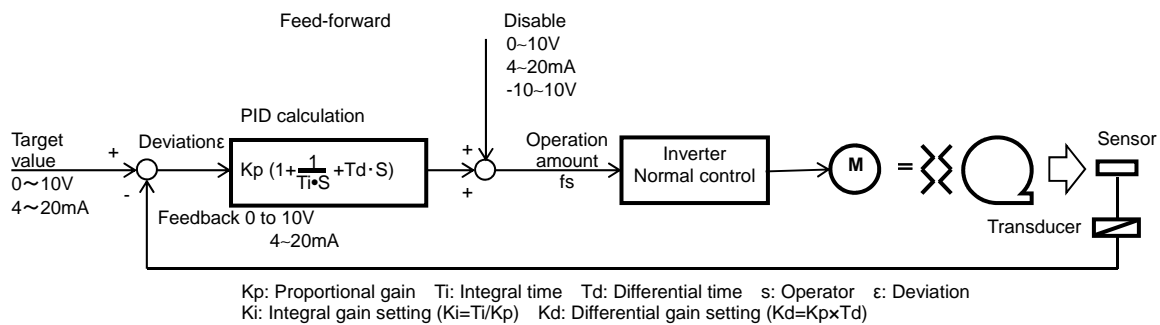

■ PID operation

- This section explains of a situation when PID target value is constant and feedback (FB) value is changed by using an example.

[1] P operation: P gain  $K_p$

- This is an operation that an operation amount of PID command value is proportional to the deviation between PID target value and current feedback (FB) value.
  - Command operation amount can be adjusted by P gain.
  - Deviation becomes (PID target value - FB value).

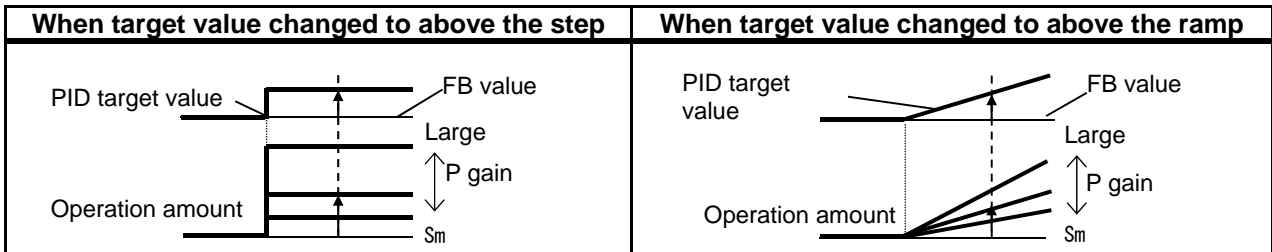

[2] I operation: I gain  $K_i$  ( $=T_i/K_p$ )

- This is an operation that an operation amount of PID command value is proportional to the time integral value of the deviation between PID target value and current feedback (FB) value.
  - Command operation amount can be adjusted by I gain.
  - Integral value can be cleared by the PIDC terminal function.
- Because output change becomes smaller as PID target value and FB value come closer based on an operation amount and it takes time to reach the target value in P operation, it is compensated with I operation.

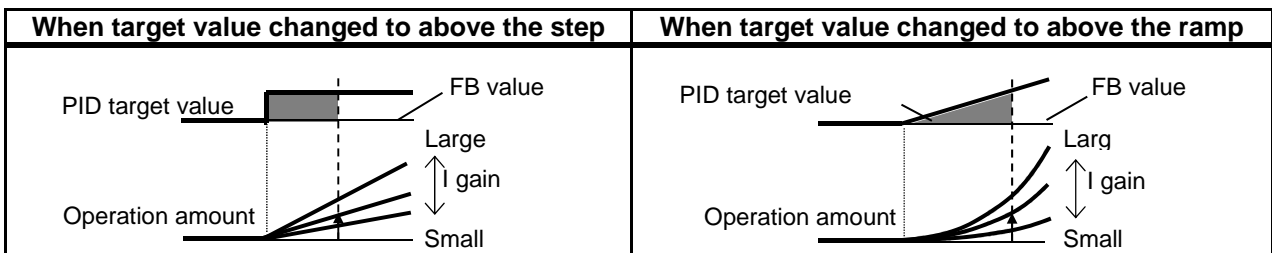

[3] D operation: D gain  $K_d$  ( $=K_p \times T_d$ )

- This is an operation that an operation amount of PID command value is proportional to the change of the deviation between PID target value and current feedback (FB) value.
  - Command operation amount can be adjusted by D gain.
  - D operation has an effect to compensate the responsiveness of P operation and I operation.

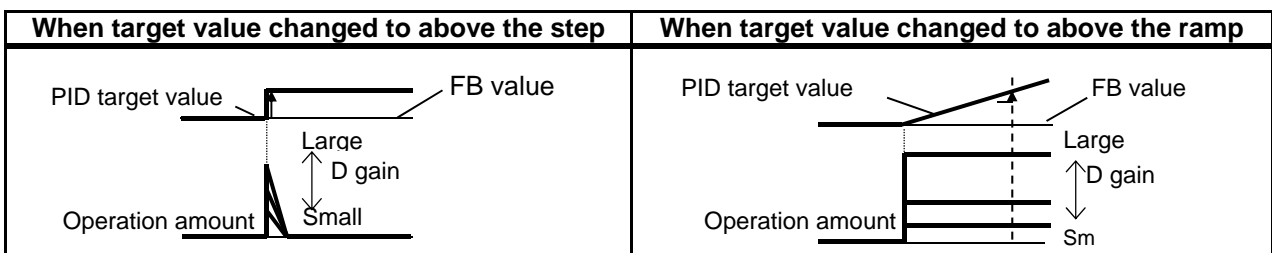

- PI operation is an operation with [1] and [2] combined.
- PD operation is an operation with [1] and [3] combined.
- PID operation is an operation with [1], [2] and [3] combined.

12.10.2 Use PID1



- PID1 can receive 3 inputs together with PID target value/PID feedback value.
- Check the following schematic diagram.

- PID gain 1 and 2 can be switched by the input terminal function [PRO].
- PID1 output can be used as a target value of PID2.

■ Block diagram of PID1 control

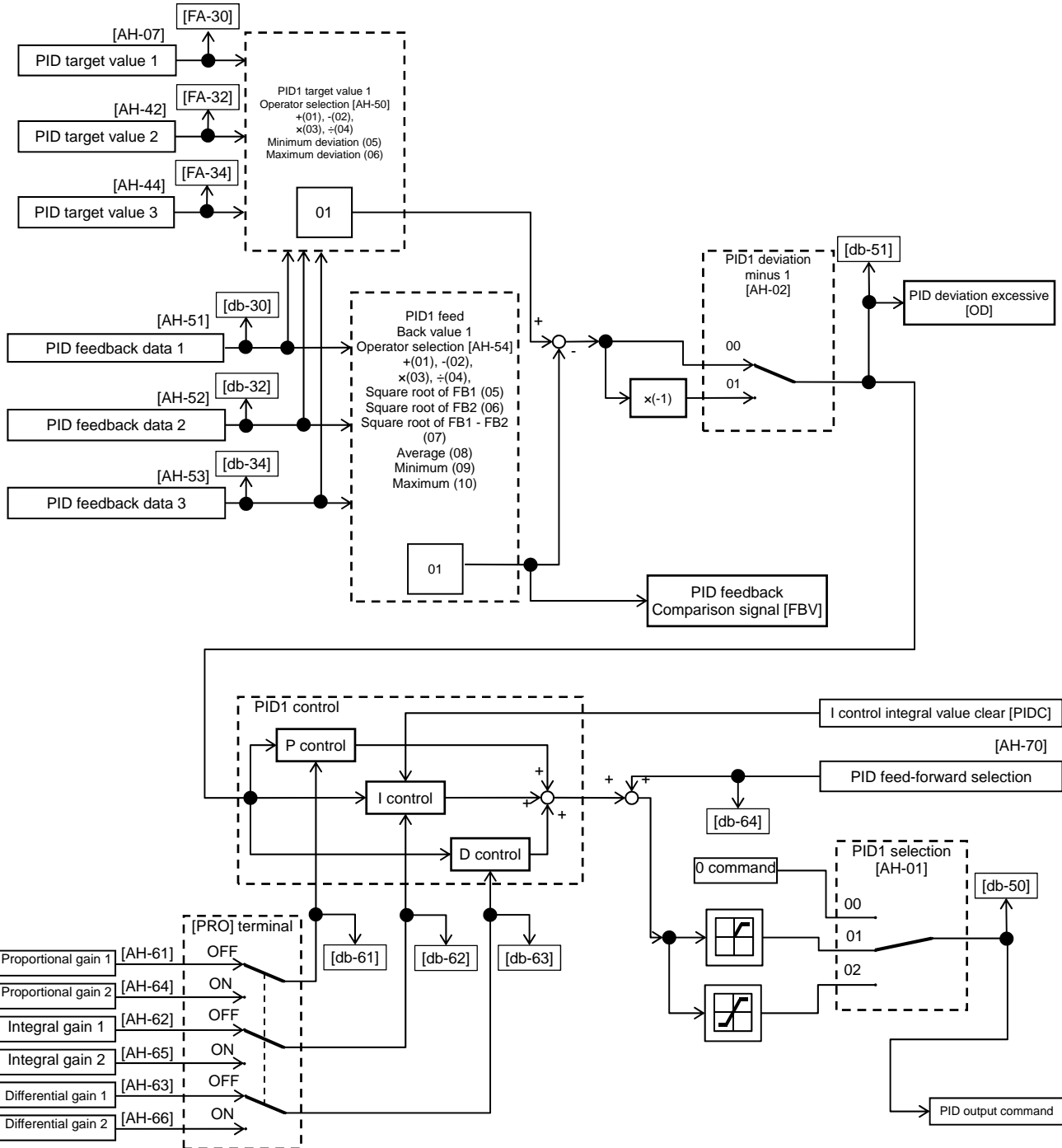

## ■ Parameter

Item	Parameter	Data	Description
PID1 selection	[AH-01]	00	Disable
		01	Enable (if command becomes negative, it does not output in a reverse direction)
		02	Enable (if command becomes negative, it outputs in a reverse direction)
PID1 deviation negative	[AH-02]	00	Disable
		01	Disable (polarity inversion of deviation)
PID1 target value 1 input destination selection	[AH-07]	00~13	00: Disable, 01: Ai1-L input, 02: Ai2-L input, 03: Ai3-L input, 04: Ai4-L input, 05: Ai5-L input, 06: Ai6-L input, 07: Parameter setting [AH-10], 08: RS 485 communication, 09: Option 1, 10: Option 2, 11: Option 3, 12: Pulse train input (main unit), 13: Pulse train input (P1-FB)
PID1 target value 1 set value 1	[AH-10]	-100.00~100.00(%)	This is a set value 1 of PID1 target value 1.
PID1 target value 2 input destination selection	[AH-42]	00~13	00: Invalid, 01: Ai1-L input, 02: Ai2-L input, 03: Ai3-L input, 04: Ai4-L input, 05: Ai5-L input, 06: Ai6-L input, 07: Parameter setting [AH-44], 08: RS 485 communication, 09: Option 1, 10: Option 2, 11: Option 3, 12: Pulse train input (main unit), 13: Pulse train input (P1-FB)
PID1 target value 2 set value	[AH-44]	-100.00~100.00(%)	This is a set value of PID1 target value 2.
PID1 target value 3 input destination selection	[AH-46]	00~13	00: Invalid, 01: Ai1-L input, 02: Ai2-L input, 03: Ai3-L input, 04: Ai4-L input, 05: Ai5-L input, 06: Ai6-L input, 07: Parameter setting [AH-48], 08: RS 485 communication, 09: Option 1, 10: Option 2, 11: Option 3, 12: Pulse train input (main unit), 13: Pulse train input (P1-FB)
PID1 target value 3 set value	[AH-48]	-100.00~100.00(%)*1)	This is a set value of PID1 target value 3.
PID1 target value 1 operator selection	[AH-50]	01	(Target value 1) + (Target value 2)
		02	(Target value 1) - (Target value 2)
		03	(Target value 1) x (Target value 2)
		04	(Target value 1) / (Target value 2)
		05	Minimum deviation among input destinations 1, 2, and 3
		06	Maximum deviation among input destinations 1, 2, and 3

\*1) Data range varies according to [AH-04] - [AH-06] settings.

Item	Parameter	Data	Description
PID1 feedback Data 1 Input destination selection	[AH-51]	00~13	00: Invalid, 01: Ai1-L input, 02: Ai2-L input, 03: Ai3-L input, 04: Ai4-L input, 05: Ai5-L input, 06: Ai6-L input, 08: RS 485 communication, 09: Option 1, 10: Option 2, 11: Option 3, 12: Pulse train input (main unit), 13: Pulse train input (P1-FB)
PID1 feedback Data 2 Input destination selection	[AH-52]	00~13	00: Invalid, 01: Ai1-L input, 02: Ai2-L input, 03: Ai3-L input, 04: Ai4-L input, 05: Ai5-L input, 06: Ai6-L input, 08: RS 485 communication, 09: Option 1, 10: Option 2, 11: Option 3, 12: Pulse train input (main unit), 13: Pulse train input (P1-FB)
PID1 feedback Data 3 Input destination selection	[AH-53]	00~13	00: Invalid, 01: Ai1-L input, 02: Ai2-L input, 03: Ai3-L input, 04: Ai4-L input, 05: Ai5-L input, 06: Ai6-L input, 08: RS 485 communication, 09: Option 1, 10: Option 2, 11: Option 3, 12: Pulse train input (main unit), 13: Pulse train input (P1-FB)
PID1 feedback Operator selection	[AH-54]	01	(FB1)+(FB2)
		02	(FB1)-(FB2)
		03	(FB1)×(FB2)
		04	(FB1)÷(FB2)
		05	Square root of FB1
		06	Square root of FB2
		07	Square root of (FB1 - FB2)
		08	Average of FB1/FB2/FB3
		09	Minimum of FB1/FB2/FB3
		10	Maximum of FB1/FB2/FB3
PID1 gain switch	[AH-60]	00	Disable (gain 1 is used)
		01	Switch by [PRO] terminal
PID1 proportional (P) gain 1	[AH-61]	0.0~100.0	Proportional gain
PID1 integral (I) gain 1	[AH-62]	0.0~3600.0(s)	Integral gain
PID1 differential (D) gain 1	[AH-63]	0.00~100.00(s)	Differential gain
PID1 proportional (P) gain 2	[AH-64]	0.0~100.0	Proportional gain
PID1 integral (I) gain 2	[AH-65]	0.0~3600.0(s)	Integral gain
PID1 differential (D) gain 2	[AH-66]	0.00~100.00(s)	Differential gain
PID1 gain switch time	[AH-67]	0~10000(ms)	Time for switch by [PRO] terminal operation
PID feed-forward selection	[AH-70]	00	Disable
		01	[Ai1] terminal input
		02	[Ai2] terminal input
		03	[Ai3] terminal input
		04	[Ai4] terminal input
		05	[Ai5] terminal input
		06	[Ai6] terminal input

### ■ Input terminal function

Item	Terminal name	Data	Description
PID disable function	[PID]	041	Disables the PID1 function by turning ON the terminal function. When disabled, operation is done by using the command set for target value as command frequency.
PID1 I control integral value clear	[PIDC]	042	Clears integral value of PID1 control.
Multi-layer target command terminal 1	[SVC1]	051	Switches multiple target values.
Multi-layer target command terminal 2	[SVC2]	052	
Multi-layer target command terminal 3	[SVC3]	053	
Multi-layer target command terminal 4	[SVC4]	054	
PID gain switch	[PRO]	055	Switches PID gain 1 and 2 by terminal.

### ■ Data monitor function

Item	Parameter	Data	Description
PID1 target value 1	[FA-30]	-100.00~100.00(%)*1)	Displays PID1 target value. Is changeable when [AH-07] = 07 or multi-layer target value 1-15 is enabled.
PID1 target value 2	[FA-32]	-100.00~100.00(%)*1)	Displays PID1 target value 2. Is changeable when [AH-42] = 07.
PID1 target value 3	[FA-34]	-100.00~100.00(%)*1)	Displays PID1 target value 3. Is changeable when [AH-46] = 07.
PID1 feedback monitor 1	[db-30]	-100.00~100.00(%)*1)	Displays PID1 feedback value 1.
PID1 feedback monitor 2	[db-32]	-100.00~100.00(%)*1)	Displays PID1 feedback value 2.
PID1 feedback monitor 3	[db-34]	-100.00~100.00(%)*1)	Displays PID1 feedback value 3.
PID1 target value monitor (after calculation)	[db-42]	-100.00~100.00(%)*1)	Displays target value after calculation by [AH-50].
PID1 feedback monitor (After calculation)	[db-44]	-100.00~100.00(%)*1)	Displays feedback value after calculation by [AH-54].
PID1 output monitor	[db-50]	-100.00~100.00(%)	Displays PID1 output value.
PID1 deviation monitor	[db-51]	-100.00~100.00(%)	Displays PID1 deviation.
PID1 deviation 1 monitor	[db-52]	-100.00~100.00(%)	Monitors 3 deviations of PID1 when [AH-50] = 05 or 06.
PID1 deviation 2 monitor	[db-53]	-100.00~100.00(%)	
PID1 deviation 3 monitor	[db-54]	-100.00~100.00(%)	
PID current P gain monitor	[db-61]	0.0~100.0	Displays current P gain.
PID current I gain monitor	[db-62]	0.00~3600.00(s)	Displays current I gain.
PID current D gain monitor	[db-63]	0.00~100.00(s)	Displays current D gain.
PID feed-forward monitor	[db-64]	-100.00~100.00(%)	Displays feed-forward command value.

\*1) Data range varies according to [AH-04] - [AH-06] settings.

- PID1 target value selection
  - Select PID1 target value.
  - In the case of setting target value with one input, set 00: None to [AH-42]/[AH-46] and 01: Add to [AH-50] to disable the input destination 2/3.

- Calculation result of operator [AH-50] will be restricted in a range of -100.00 to 100.00 (%).
- When 01 to 04 is selected in operator [AH-50], calculation is targeted to target value 1 and target value 2.

■ When operator [AH-50] is 01 to 04

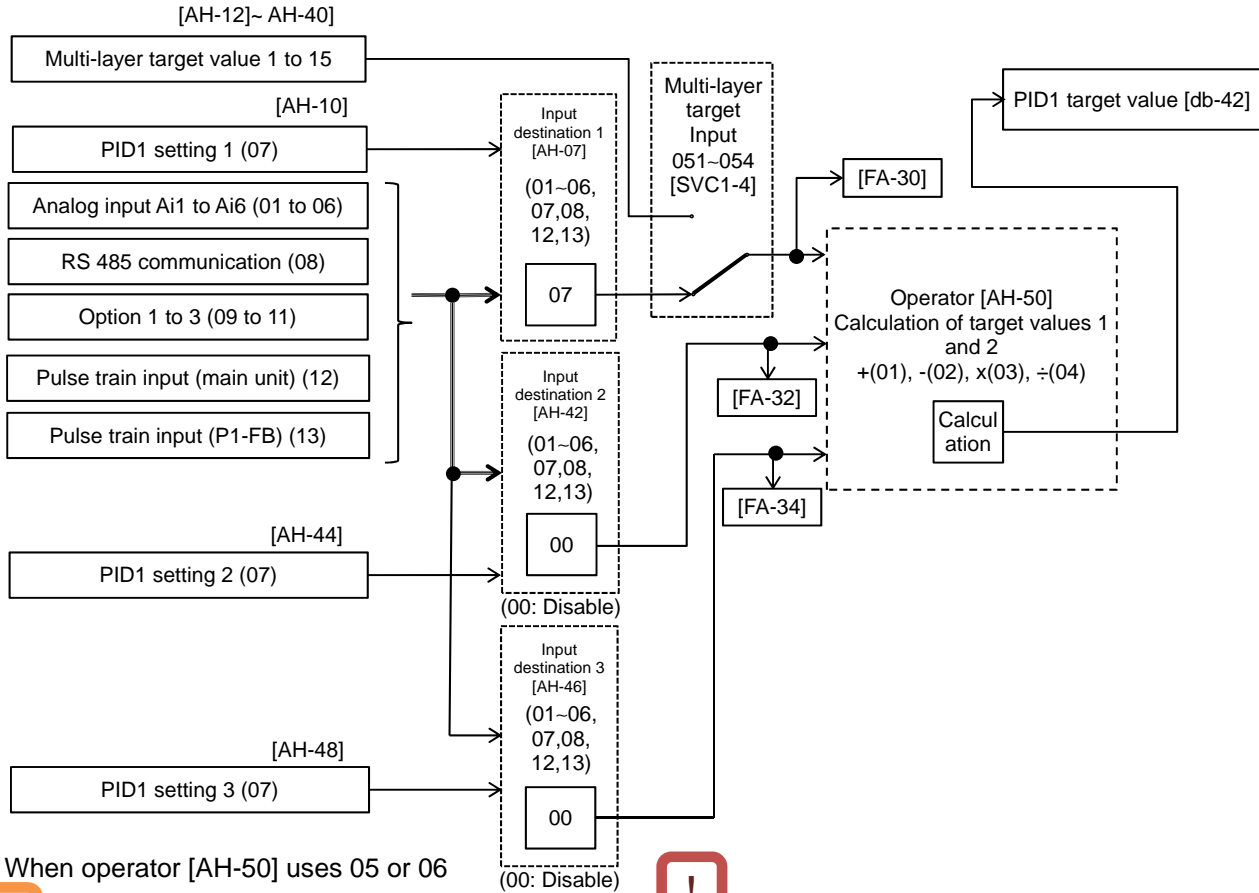

■ When operator [AH-50] uses 05 or 06



- When 05 or 06 is selected in operator [AH-50], (Target value 1) - (Feedback value 1), (Target value 2) - (Feedback value 2), (Target value 3) - (Feedback value 3) these 3 deviations are compared and PID calculation is performed by using the deviation of minimum (05)/maximum (06).

- Select 00: Disable for target value and feedback value not in use.

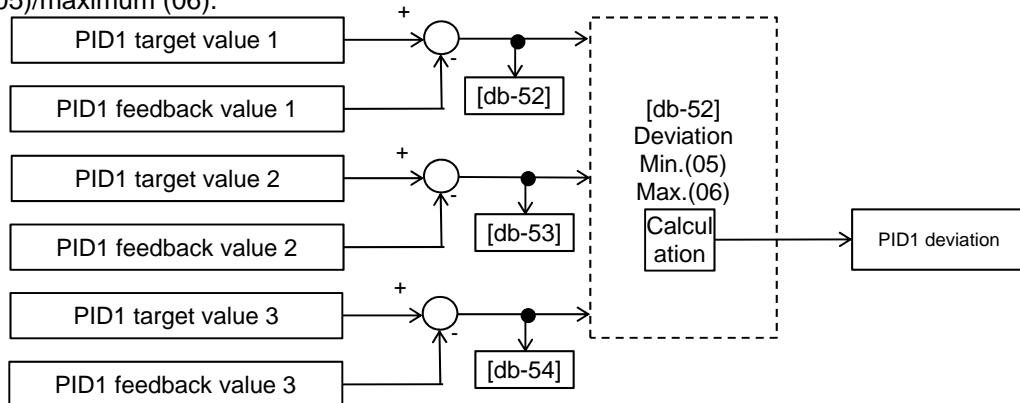

■ PID target value multi-layer switch function



- PID1 multi-layer target value (0 to 15 speed) become selectable by assigning 051 to 054 ([SVC1] to [SVC4]) to input terminals 1 to 9, A or B selection [CA-01] to [CA-11].

■ Operation table

Multi-layer target	SVC4	SVC3	SVC2	SVC1	Parameter
Target value 0	OFF	OFF	OFF	OFF	[AH-10]*1)
Target value 1	OFF	OFF	OFF	ON	[AH-12]
Target value 2	OFF	OFF	ON	OFF	[AH-14]
Target value 3	OFF	OFF	ON	ON	[AH-16]
Target value 4	OFF	ON	OFF	OFF	[AH-18]
Target value 5	OFF	ON	OFF	ON	[AH-20]
Target value 6	OFF	ON	ON	OFF	[AH-22]
Target value 7	OFF	ON	ON	ON	[AH-24]
Target value 8	ON	OFF	OFF	OFF	[AH-26]
Target value 9	ON	OFF	OFF	ON	[AH-28]
Target value 10	ON	OFF	ON	OFF	[AH-30]
Target value 11	ON	OFF	ON	ON	[AH-32]
Target value 12	ON	ON	OFF	OFF	[AH-34]
Target value 13	ON	ON	OFF	ON	[AH-36]
Target value 14	ON	ON	ON	OFF	[AH-38]
Target value 15	ON	ON	ON	ON	[AH-40]

\*1) When [AH-07] = 07. Follow the setting of [AH-07].



- Stand-by time until terminal input finalization is settable by multi-layer input finalize time [CA-55]. It prevents the transition status of switching terminals from being selected.
- Data is finalized after the elapse of a set time for [AC-55] without input changes. Please be noted that setting a longer finalize time makes the input response slow.

■ Operation graph

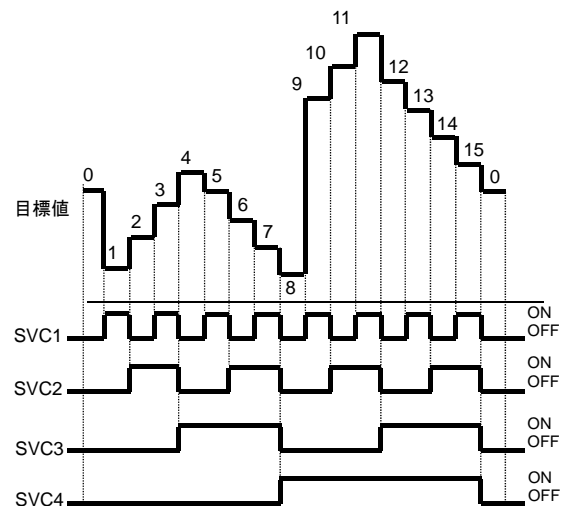

■ Input terminal function

Item	Terminal name	Data	Description
Multi-layer target command terminal 1	[SVC1]	051	Switches multiple target values.
Multi-layer target command terminal 2	[SVC2]	052	
Multi-layer target command terminal 3	[SVC3]	053	
Multi-layer target command terminal 4	[SVC4]	054	



■ PID1 target value selection

Item	Parameter	Data	Description
PID1 target value 1 input destination	[AH-07]	00~13	00: Invalid, 01: Ai1-L input, 02: Ai2-L input, 03: Ai3-L input, 04: Ai4-L input, 05: Ai5-L input, 06: Ai6-L input, 07: Parameter setting [AH-10], 08: RS 485 communication, 09: Option 1, 10: Option 2, 11: Option 3, 12: Pulse train input (main unit), 13: Pulse train input (P1-FB)
PID1 target value 1 set value	[AH-10]	0.00~100.00[%]*1)	Is a parameter set value.
PID1 multi-layer target value 1	[AH-12]		
PID1 multi-layer target value 2	[AH-14]		
PID1 multi-layer target value 3	[AH-16]		
PID1 multi-layer target value 4	[AH-18]		
PID1 multi-layer target value 5	[AH-20]		
PID1 multi-layer target value 6	[AH-22]		
PID1 multi-layer target value 7	[AH-24]		
PID1 multi-layer target value 8	[AH-26]		
PID1 multi-layer target value 9	[AH-28]		
PID1 multi-layer target value 10	[AH-30]		
PID1 multi-layer target value 11	[AH-32]		
PID1 multi-layer target value 12	[AH-34]		
PID1 multi-layer target value 13	[AH-36]		
PID1 multi-layer target value 14	[AH-38]		
PID1 multi-layer target value 15	[AH-40]		
PID1 target value 2 input destination selection	[AH-42]	00~13	00: Invalid, 01: Ai1-L input, 02: Ai2-L input, 03: Ai3-L input, 04: Ai4-L input, 05: Ai5-L input, 06: Ai6-L input, 07: Parameter setting [AH-44], 08: RS 485 communication, 09: Option 1, 10: Option 2, 11: Option 3, 12: Pulse train input (main unit), 13: Pulse train input (P1-FB)
PID1 target value 2 set value	[AH-44]	0.00~100.00[%]*1)	Is a parameter set value.
PID1 target value 3 input destination selection	[AH-46]	00~13	00: Invalid, 01: Ai1-L input, 02: Ai2-L input, 03: Ai3-L input, 04: Ai4-L input, 05: Ai5-L input, 06: Ai6-L input, 07: Parameter setting [AH-48], 08: RS 485 communication, 09: Option 1, 10: Option 2, 11: Option 3, 12: Pulse train input (main unit), 13: Pulse train input (P1-FB)
PID1 target value 3 set value	[AH-48]	0.00~100.00[%]*1)	Is a parameter set value.
PID1 target value operator selection	[AH-50]	01	(Target value 1) + (Target value 2)
		02	(Target value 1) - (Target value 2)
		03	(Target value 1) x (Target value 2)
		04	(Target value 1) / (Target value 2)
		05	Minimum of deviation 1 (Target value 1 - FB 1), deviation 2 (Target value 2 - FB 2), and deviation 3 (Target value 3 - FB 3)
		06	Maximum of deviation 1 (Target value 1 - FB 1), deviation 2 (Target value 2 - FB 2), and deviation 3 (Target value 3 - FB 3)

\*1) Data range varies according to [AH-04] - [AH-06] settings.

■ PID1 feedback data selection

**A**

- This selects PID1 feedback data.
- In the case of setting feedback data with one input, set 00: None to [AH-52]/[AH-53] and 01: Add to [AH-54] to disable the input destination 2/3.

- Calculation result of operator [AH-54] will be restricted in a range of -100.00 to 100.00 (%).

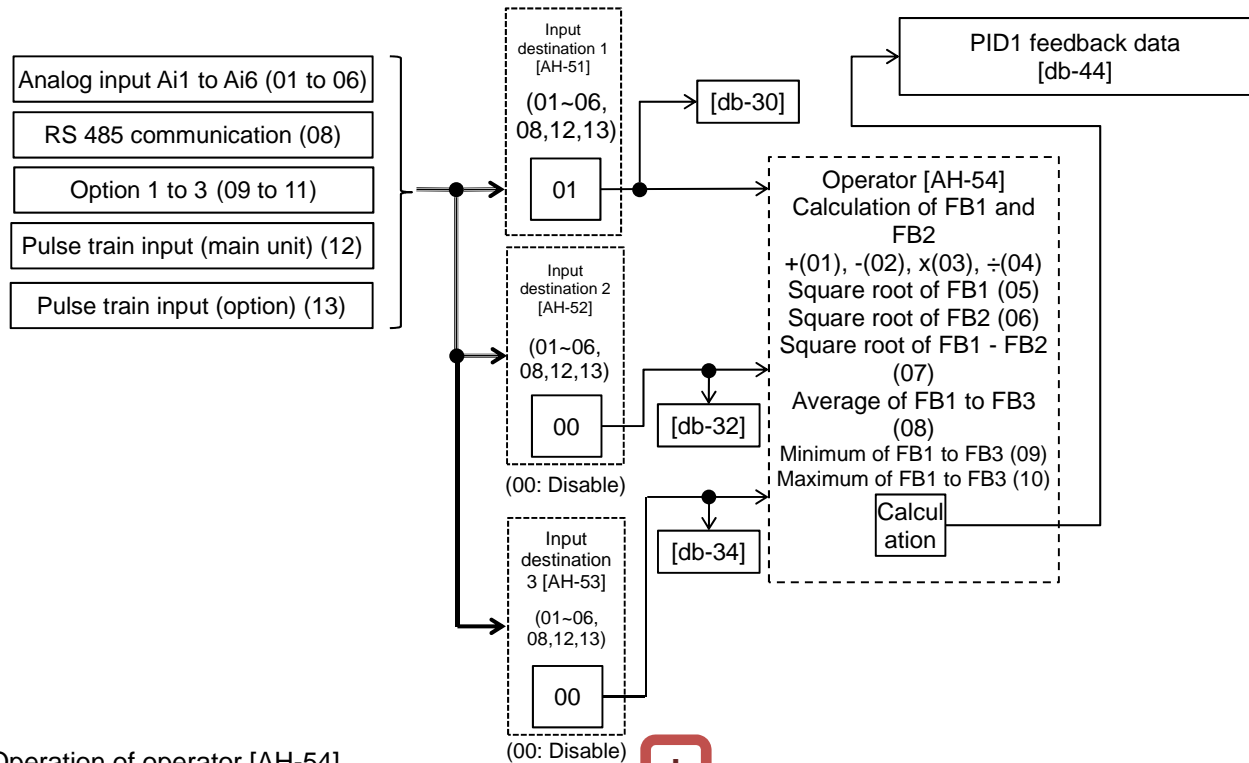

■ Operation of operator [AH-54]

**A**

- When 01 to 07 is selected in operator [AH-54], calculation will be targeted to feedback data 1 and feedback data 2.
- When 08 to 10 is selected in operator [AH-54], calculation will be targeted to feedback data 1 to 3.

**!**

- Select 00: Disable for feedback value not in use.
- Operator [AH-54] will be available to be selected only when 01 to 04 is selected for target value operator [AH-50].

■ Output of ± switching PID1 deviation

**A**

- Output is feasible by switching ± PID1 deviation.
- When PID1 deviation minus [AH-02] is 00, calculation will be performed by (PID target value - FB value). With 01, it will be the same operation as (FB value - PID target value).
- Use this when the polarity of deviation of PID target value and FB value does not much with the command from the inverter due to sensor characteristics, etc.

- e.g.) Control the compressor for refrigerator.  
 When the temperature sensor specification is -20 to 100°C: 0 to 10 (V) and the target value is 0°C, and if the current temperature is 10°C, the speed will decrease in normal PID control as it is (FB value) > (PID target value).
- The inverter will raise the speed if [AH-02] = 01 is set.

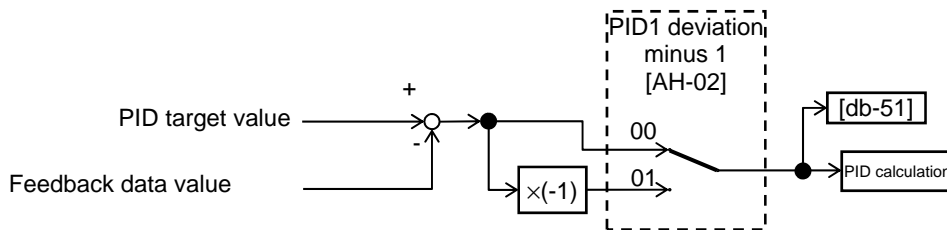

■ PID1 feed-forward value selection

**A**

- Select PID1-feed forward value.

- Feed-forward control operates by setting [AH-70] to anything other than 00 (None).

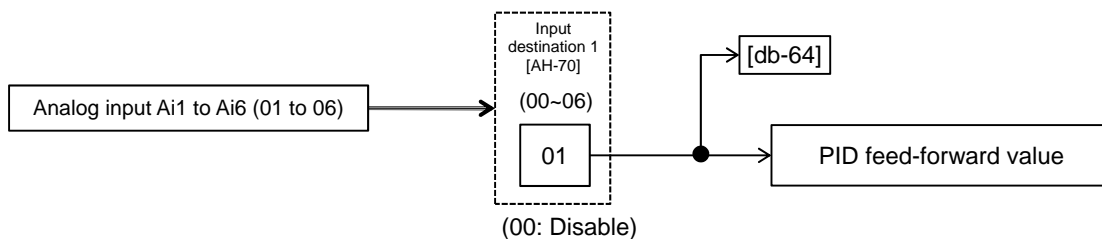

■ PID1 changeable range limitation



- PID output is restricted to a changeable range based on the target value.
- When [AH-71] is 0.00, the function will be disabled.

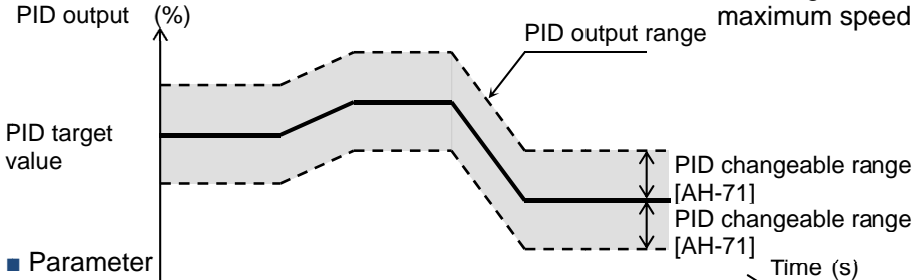

- In the case of using this function, set PID changeable range [AH-71]. Restriction will be made in a range of PID target value  $\pm$  [AH-71] with the maximum speed as 100%.

■ Parameter

Item	Terminal name	Data	Description
PID changeable range	[AH-71]	0.00~100.00(%)	Changeable range based on the target value

■ PID1 reverse output



- In normal PID control, the inverter does not output a negative figure for frequency command and limits at 0 Hz, when result of PID calculation was negative. If you select 02 (with reverse output) for PID1 selection [AH-01], frequency command can be output in a reverse direction, when result of PID calculation was negative.



- When [AH-01] is set to 02 (with reverse output), the PID changeable range limit function [AH-71] will be extended to the negative direction.

■ PID1 I control integral reset function [PIDC]



- This is a function to clear the integral figure of PID operation.
- In the case of turning ON the [PIDC] terminal, do so when PID is not in operation.



- Turning ON the [PIDC] terminal during PID operation clears the integral value added to the PID output command and changes the PID output command value abruptly, resulting in an over-current error.

■ PID1 disable function [PID]



- Turning ON the terminal temporarily disables PID operation and performs output according to frequency command.
- The input value as PID command will be adopted for frequency command.

■ Adjust PID1 control

- When response is not stabilized in PID function operation, adjust according to the following procedure.



- If acceleration/deceleration time is set too long, following of output frequency will be delayed and control may not be successful. In this case, set the acceleration/deceleration time short.

Phenomenon ▶	Examples of measures
<ul style="list-style-type: none"> <li>• Output response is slow and feedback value does not change swiftly even if PID target value was changed.</li> </ul>	<ul style="list-style-type: none"> <li>• Increase PID1 proportional (P) gain 1 [AH-61].</li> </ul>
<ul style="list-style-type: none"> <li>• Feedback value changes swiftly and is not stabilized.</li> <li>• Overshooting or hunting occurs.</li> </ul>	<ul style="list-style-type: none"> <li>• Decrease PID1 proportional (P) gain 1 [AH-61].</li> </ul>
<ul style="list-style-type: none"> <li>• Feedback value vibrates mildly.</li> <li>• t takes time for operation to be stabilized.</li> </ul>	<ul style="list-style-type: none"> <li>• Increase PID1 integral (I) gain 1 [AH-62].</li> </ul>
<ul style="list-style-type: none"> <li>• PID target value and feedback value do not match easily.</li> </ul>	<ul style="list-style-type: none"> <li>• Decrease PID1 integral (I) gain 1 [AH-62].</li> </ul>
<ul style="list-style-type: none"> <li>• Response is slow even if proportional gain was increased.</li> <li>• Small hunting occurs.</li> </ul>	<ul style="list-style-type: none"> <li>• Increase PID1 differential (D) gain 1 [AH-63].</li> </ul>
<ul style="list-style-type: none"> <li>• Response due to disturbance is large and it takes time until stabilization.</li> </ul>	<ul style="list-style-type: none"> <li>• Decrease PID1 differential (D) gain 1 [AH-63].</li> </ul>

■ Control by switching PID1 gain

- PID gain 1 and 2 can be switched by switching the input terminal function 055 [PRO].

- In the case of using the [PRO] terminal, set 01 to PID1 gain switch method selection [AH-60].

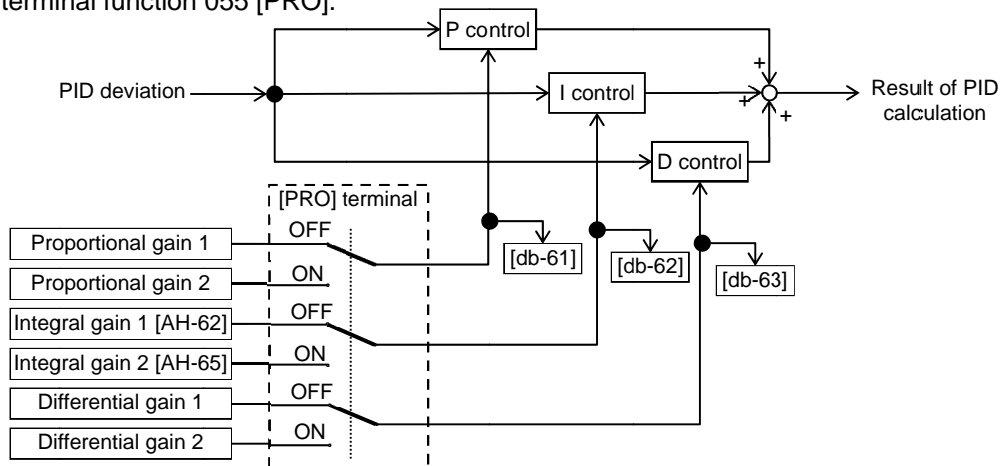

- PID gain is time for PID1 gain to switch [AH-67] and switches continuously.

- Each gain selected for PIDs can be checked by respective monitors [db-61] to [db-63].

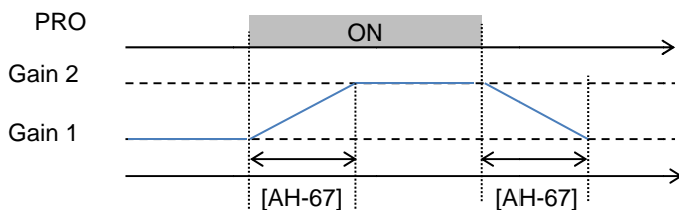

**12.10.3** PID Soft-start

■ PID soft-start function

**A**

- In the case of using this function, enable PID control and set 01 to the [AH-75] PID soft-start function selection.
- It will move to PID control automatically after the elapse of the time set in [AH-80].
- It accelerates to soft-start target level [AH-76] after start of soft-start.

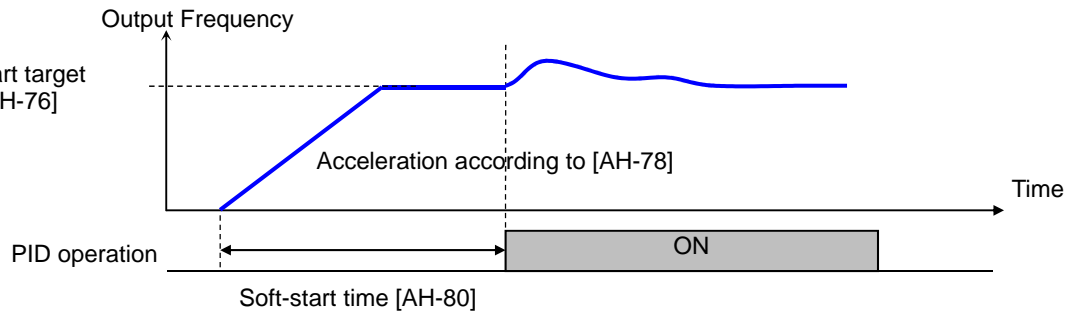

■ Parameter

Item	Parameter	Data	Description
PID soft-start function selection	[AH-75]	00	Disable
		01	Enable
PID soft-start target level	[AH-76]	0.00~100.00(%)	It is a target value of the soft-start range with the maximum frequency as 100%.
For PID soft-start acceleration time	[AH-78]	0.00~3600.00(s)	Sets acceleration time at the time of soft-start.
PID soft-start time	[AH-80]	0.00~100.00(s)	Is soft-start operation time.

■ PID start abnormal judgment

**A**

- It is a function to detect breakage of pipes such as water leakage.
- Abnormality will be judged when PID-FB value is lower than [AH-82] PID start abnormality judgment level after the elapse of [AH-80] soft-start time following PID soft-start.

- Abnormal operations vary depending on the setting of [AH-81] PID start abnormality judgment implementation selection at the time of abnormality judgment.
  - Nothing will be done when [AH-81] is 00.
  - When [AH-81] is 01, it will trip with [E120] PID start abnormality error after the abnormal status elapsed the set time for [AH-80].
  - When [AH-81] is 02, the [SSE] terminal will be turned ON after the abnormal status elapsed the set time of [AH-80].  
The [SSE] terminal will stay ON until it stops.

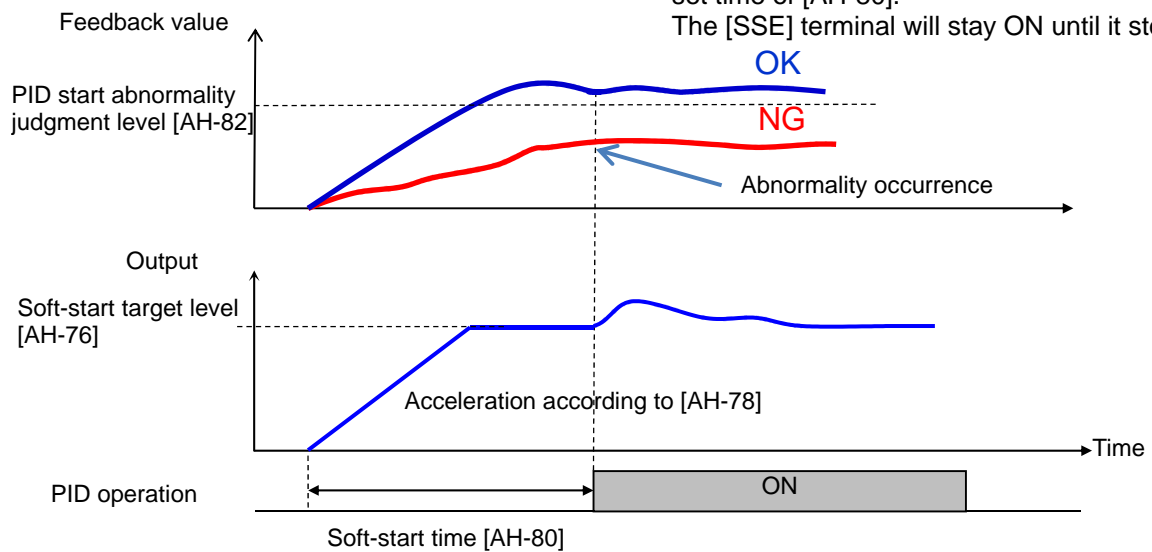

■ Parameter

Item	Parameter	Data	Description
PID start abnormal judgment implement selection	[AH-81]	00	Disable
		01	Enable It will trip with [E120] PID start abnormality error when start abnormality is judged.
		02	Enable The [SSE] terminal will be turned ON when start abnormality is judged.
PID start abnormality judgment level	[AH-82]	0.00~100.00(%)	Is a level to judge start abnormality.

### 12.10.4 PID Sleep

#### ■ PID sleep function

**A**

- In the case of using this function, set 01 (output low) or 02 (SLEP terminal) to PID sleep condition selection [AH-85].
- You can change the start/cancel time and level of the sleep operation depending on the usage.

- You can choose cancellation of the PID sleep status from 01 (deviation amount), 02 (feedback low), and 03 (WAKE terminal) of the PID wake condition selection [AH-93].
- In the case of canceling the PID sleep status by deviation, cancellation will only be activated when deviation increases in a direction of lower output, even if PID1 deviation [AH-02] was set to 01 and PID deviation  $\pm$  was switched.

#### ■ Parameter

Item	Parameter	Data	Description
PID sleep condition selection	[AH-85]	00	Disable
		01	Starts sleep operation when output is low
		02	Starts operation at the rising edge of the [SLEP] terminal
PID sleep start level	[AH-86]	0.00~590.00(Hz)	Is a level of making a judgment of sleep operation for the output speed when [AH-85] = 01.
PID sleep operation time	[AH-87]	0.00~100.00(s)	Is stand-by time before shifting to sleep operation.
Boost selection prior to PID sleep	[AH-88]	00	Disable
		01	Boosts target value before sleep operation.
Boost time prior to PID sleep	[AH-89]	0.00~100.00(s)	Is actuation time prior to PID sleep.
Boost amount prior to PID sleep	[AH-90]	0.00~100.00(%)	Sets a boost amount to be added to target value before sleep.
Minimum operation time prior to PID sleep	[AH-91]	0.00~100.00(s)	Does not start sleep operation until [AH-91] has elapsed from start.
PID sleep status minimum retaining time	[AH-92]	0.00~100.00(s)	Retains the sleep status until [AH-92] has elapsed, once the sleep operation started.
PID wake condition selection	[AH-93]	01	Cancels the sleep operation when a deviation amount increases in a deceleration direction.
		02	Cancels the sleep operation when feedback value decreases.
		03	Cancels the operation at the rising edge of the [WAKE] terminal
PID wake start level	[AH-94]	0.00~100.00(%)	Cancels the operation when feedback value goes below the set value when [AH-93] is 02.
PID wake operation time	[AH-95]	0.00~100.00(s)	Is stand-by time for operation cancellation when [AH-93] is 02.
PID wake start deviation amount	[AH-96]	0.00~100.00(%)	Cancels the operation when a deviation between target value and feedback value increases when [AH-93] is 01.

#### ■ Input terminal function

Item	Terminal name	Data	Description
PID sleep start terminal	[SLEP]	057	Starts the sleep function with the terminal when [AH-85] = 02.
PID sleep cancel terminal	[WAKE]	058	Cancels the sleep function with the terminal when [AH-93] = 03.



Example 1) [AH-85] sleep start: 01 (output low)

- Sleep operation starts when the output frequency stays below the level of [AH-86] continuously for the set time of [AH-87].

[AH-93] Sleep cancel: 01 (deviation amount)

- Cancel operation will start when PID deviation stays over [AH-96] continuously for the set time of [AH-95]. Deviation operates with either figure ( $\pm$ ).

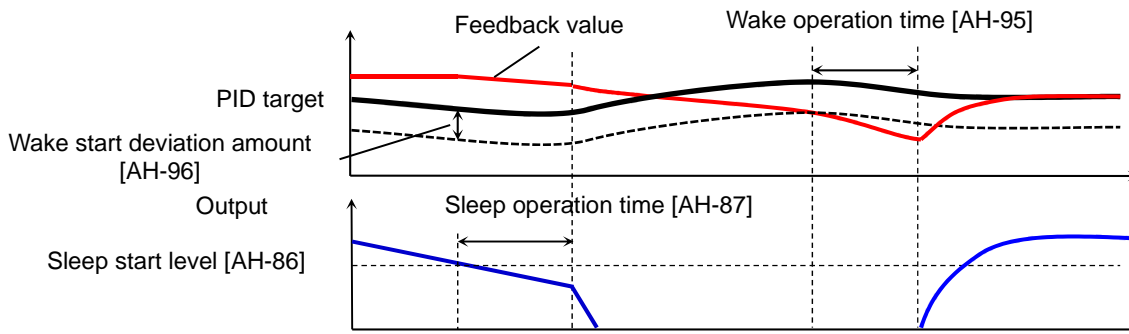

Example 2) [AH-85] sleep start: 01 (output low)

- Sleep operation will start when the output frequency stays below [AH-86] continuously for the set time of [AH-87].

[AH-93] Sleep cancel: 02 (feedback low)

- Cancel operation will start when feedback stays below [AH-94] continuously for the set time of [AH-95].

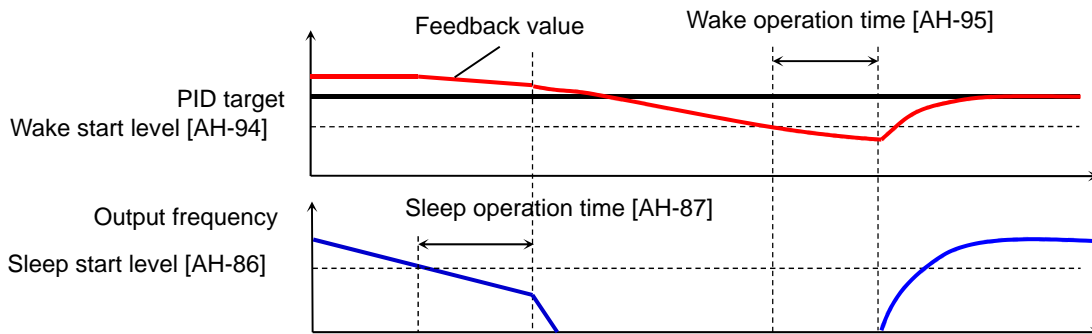

Example 3) [AH-85] sleep start: 02 ([SLEP] terminal)

- Sleep operation starts after the elapse of [AH-87] from the ON edge of the [SLEP] terminal.

[AH-93] Sleep cancel: 03 ([WAKE] terminal)

- Sleep operation will start after the elapse of [AH-95] from the ON edge of the [WAKE] terminal.

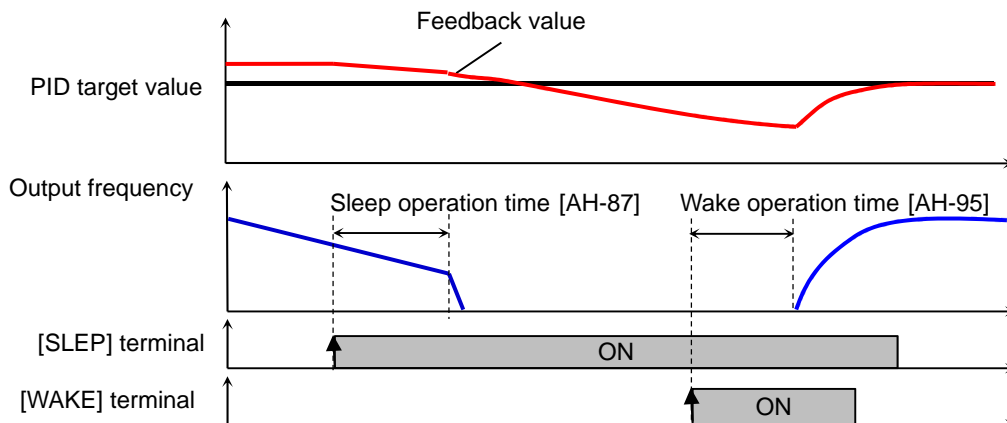

Boost function prior to sleep

**A**

- This raises the PID target value before sleep and increases the feedback amount once. By this, the sleep status can be maintained for a long period of time.
- The diagram below is an example when 01 is set to [AH-85] and 02 to [AH-93].

- When [AH-85] is 01, the set value of [AH-90] will be added to the PID target value for the set time of [AH-89], if the output frequency stayed below [AH-86] continuously.

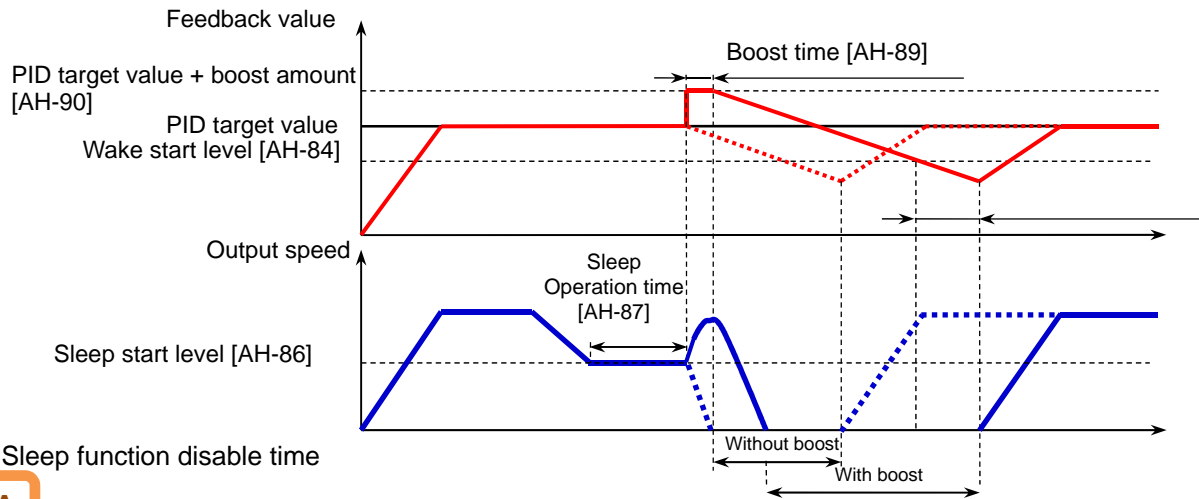

Sleep function disable time

**A**

- Minimum operation time from start to sleep [AH-91] and minimum retaining time of the sleep status [AH-92] can be set.

- PID sleep operation can prevent the operation of switching between the sleep status and operation status frequently.

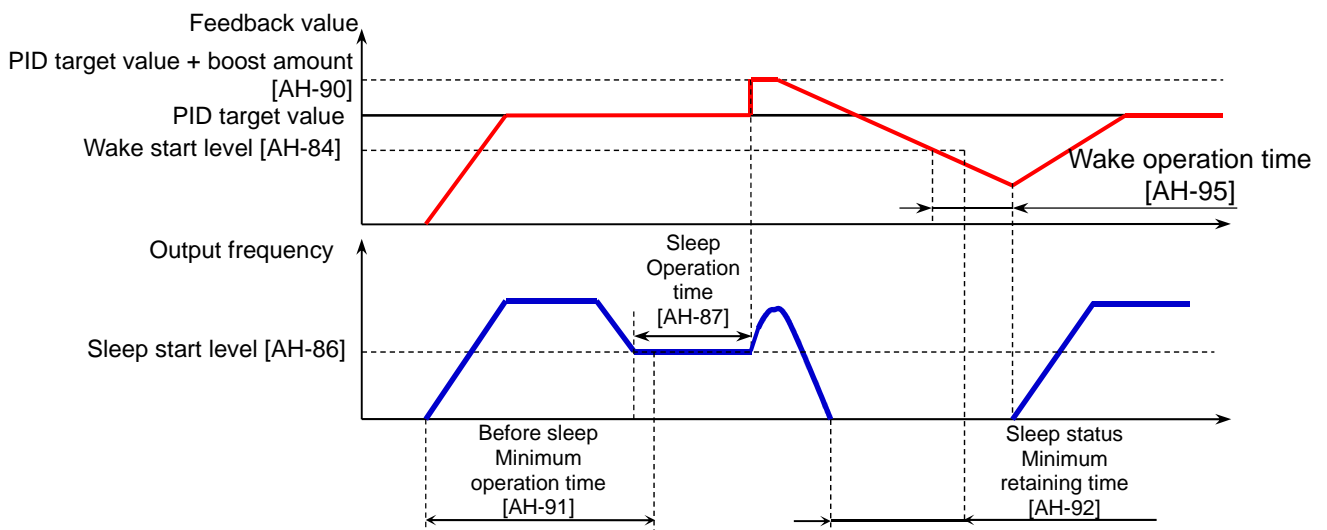

12.10.5 Use PID2/PID3/PID4

PID2/PID3/PID4 control



- PID1 to PID4 controls operate independently.
- Switching PID1 to 4 by terminal enables the use for switching batch control, etc.

- In PID2, selecting PID1 output to target value enables control in consideration of influences from the 2 systems.

Schematic diagram of PID2 control

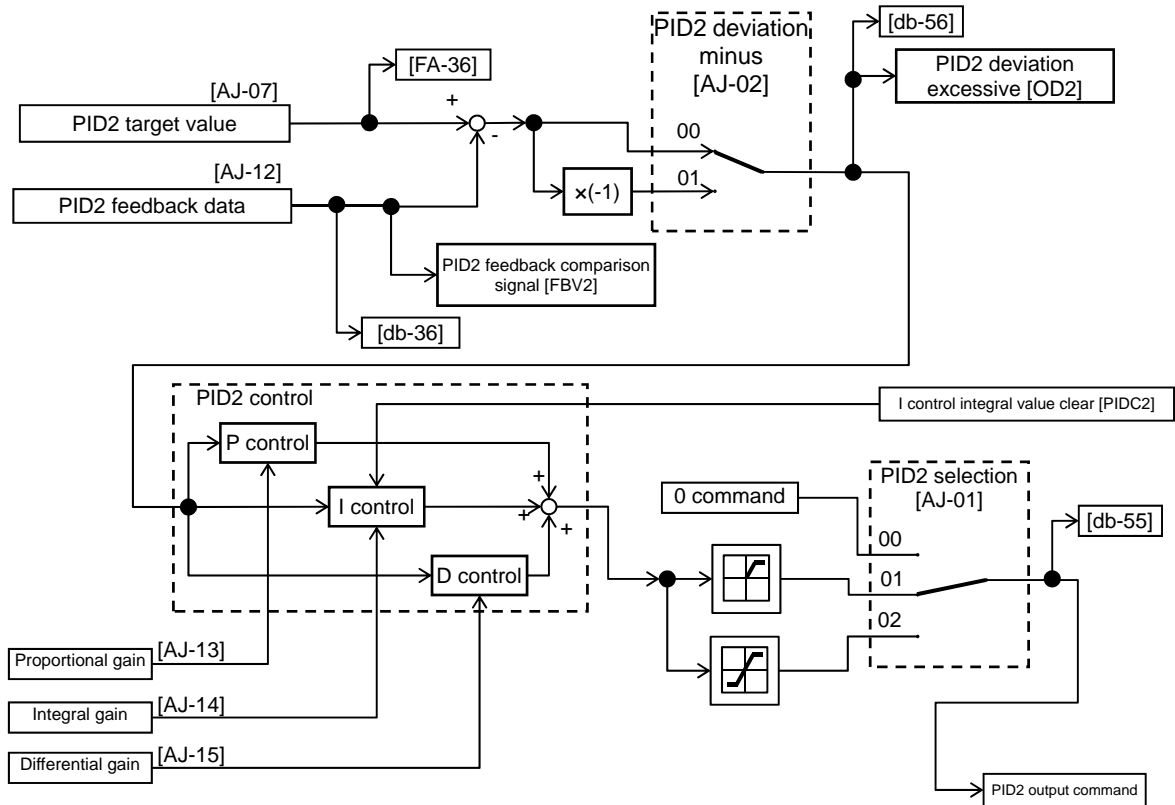

■ Schematic diagram of PID3 control

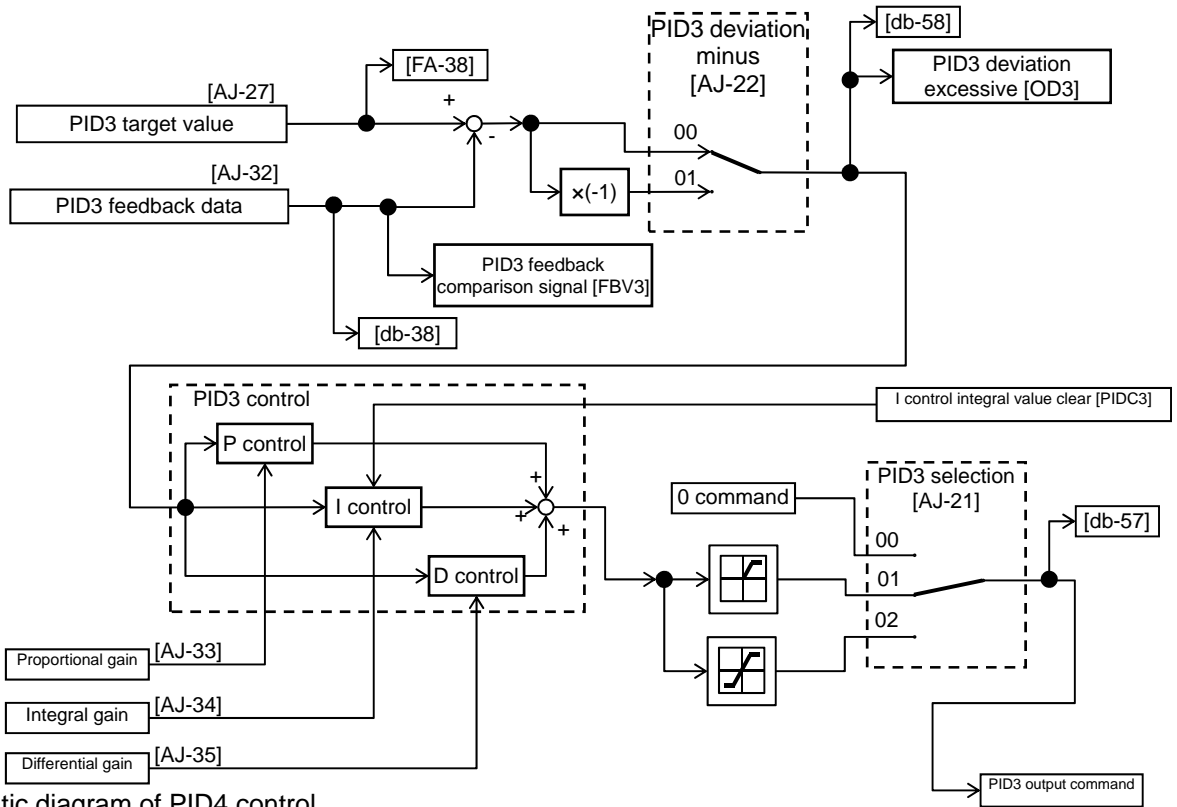

■ Schematic diagram of PID4 control

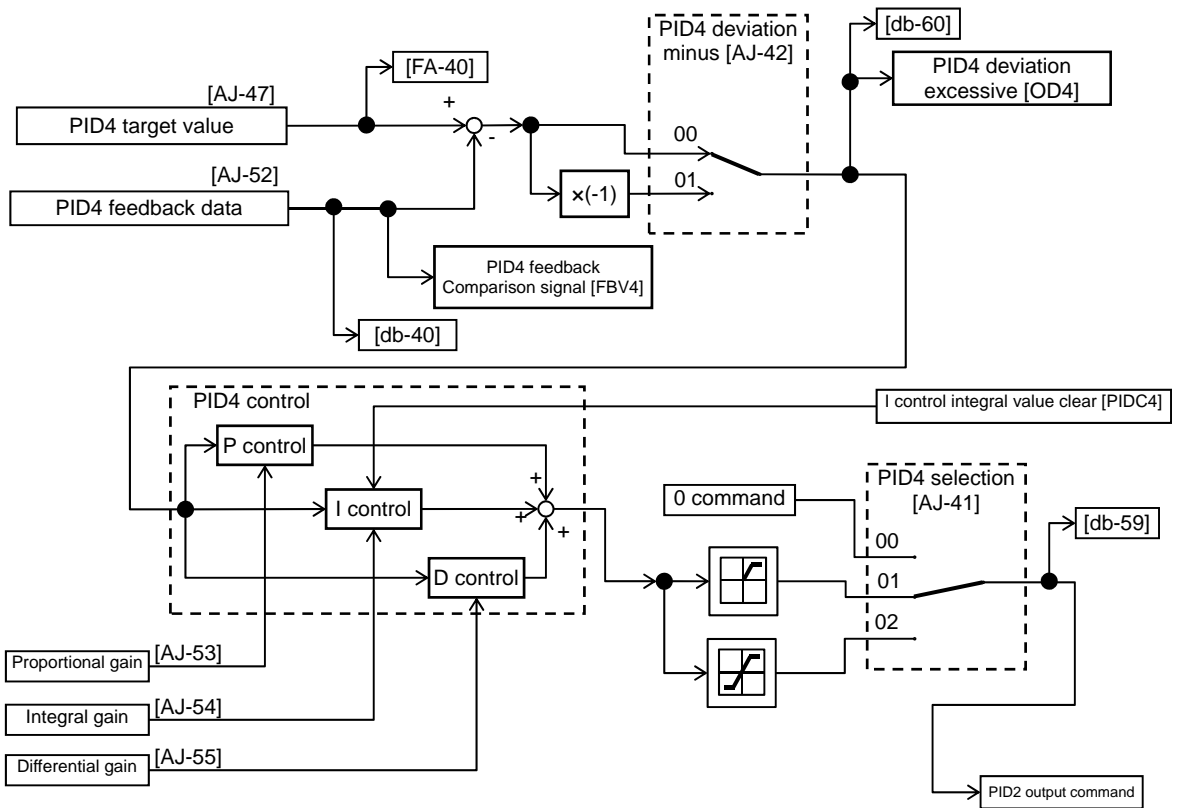

■ Switch PID1 to 4

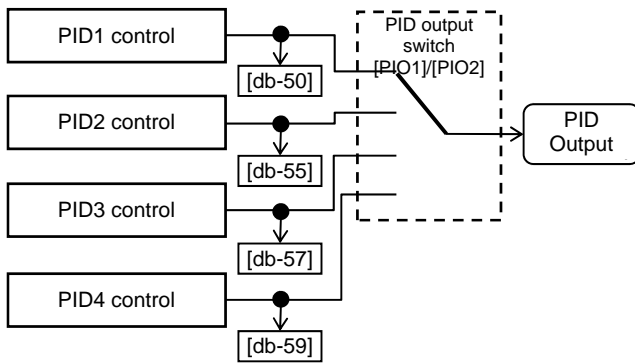

- Switching the input terminal function 056[PIO1]/057[PIO2] enables switching and controlling of PID1 to PID4.

Combination of PIO1/PIO2

	[PIO2]	[PIO1]
PID1 is enabled	OFF	OFF
PID2 is enabled	OFF	ON
PID3 is enabled	ON	OFF
PID4 is enabled	ON	ON

■ Connect PID1 and PID2

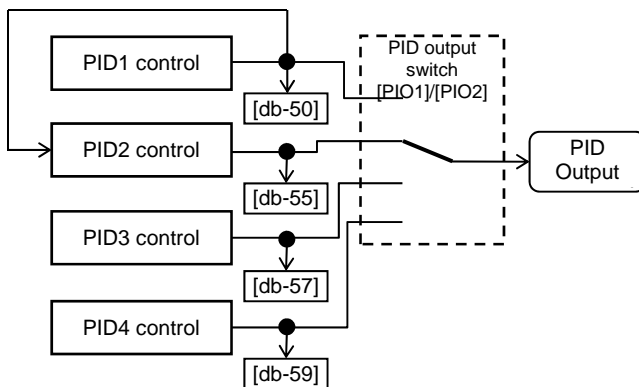

- Setting the target value of PID2 to PID1 output ([AJ-07] = 15) enables double-layer control of PID. (PID3/PID4 cannot be selected.)
- Enable PID2 output command as follows.

Combination of PIO1/PIO2

	[PIO2]	[PIO1]
PID2 is enabled	OFF	ON

## ■ Parameter

Item	Parameter	Data	Description
PID2 selection	[AJ-01]	00	Disable
		01	Enable (if command becomes negative, it does not output in a reverse direction)
		02	Enable (if command becomes negative, it outputs in a reverse direction)
PID2 deviation negative	[AJ-02]	00	Disable
		01	Disable (polarity inversion of deviation)
PID2 target value input destination	[AJ-07]	00~15	00: Disable, 01: Ai1-L input, 02: Ai2-L input, 03: Ai3-L input, 04: Ai4-L input, 05: Ai5-L input, 06: Ai6-L input, 07: Parameter setting [AH-44], 08: RS 485 communication, 09: Option 1, 10: Option 2, 11: Option 3, 12: Pulse train input (main unit), 13: Pulse train input (P1-FB), 15: PID1 output
PID2 target value set value	[AJ-10]	0.00~100.00(%)*1	Is a parameter set value.
PID2 feedback data input destination	[AJ-12]	00~13	00: Disable, 01: Ai1-L input, 02: Ai2-L input, 03: Ai3-L input, 04: Ai4-L input, 05: Ai5-L input, 06: Ai6-L input, 07: Parameter setting [AH-44], 08: RS 485 communication, 09: P option 1, 10: Option 2, 11: Option 3, 12: Pulse train input (main unit), 13: Pulse train input (P1-FB)
PID2 proportional (P) gain	[AJ-13]	0.0~100.0	Proportional gain
PID2 integral (I) gain	[AJ-14]	0.0~3600.0(s)	Integral gain
PID2 differential (D) gain	[AJ-15]	0.00~100.00(s)	Differential gain
PID3 selection	[AJ-21]	00	Disable
		01	Enable (if command becomes negative, it does not output in a reverse direction)
		02	Enable (if command becomes negative, it outputs in a reverse direction)
PID3 deviation negative	[AJ-22]	00	Disable
		01	Enable (polarity inversion of deviation)
PID3 target value input destination	[AJ-27]	00~13	00: Disable, 01: Ai1-L input, 02: Ai2-L input, 03: Ai3-L input, 04: Ai4-L input, 05: Ai5-L input, 06: Ai6-L input, 07: Parameter setting [AH-44], 08: RS 485 communication, 09: Option 1, 10: Option 2, 11: Option 3, 12: Pulse train input (main unit), 13: Pulse train input (P1-FB)
PID3 target value set value	[AJ-30]	0.00~100.00(%)*2	Is a parameter set value.
PID3 feedback data input destination	[AJ-32]	00~13	00: Disable, 01: Ai1-L input, 02: Ai2-L input, 03: Ai3-L input, 04: Ai4-L input, 05: Ai5-L input, 06: Ai6-L input, 07: Parameter setting [AH-44], 08: RS 485 communication, 09: Option 1, 10: Option 2, 11: Option 3, 12: Pulse train input (main unit), 13: Pulse train input (P1-FB)
PID3 proportional (P) gain	[AJ-33]	0.0~100.0	Proportional gain
PID3 integral (I) gain	[AJ-34]	0.0~3600.0(s)	Integral gain
PID3 differential (D) gain	[AJ-35]	0.00~100.00(s)	Differential gain

\*1) Data range varies according to [AJ-04] - [AJ-06] settings.

\*2) Data range varies according to [AJ-24] - [AJ-26] settings.

## ■ Parameter

Item	Parameter	Data	Description
PID4 selection	[AJ-41]	00	Disable
		01	Enable (if command becomes negative, it does not output in a reverse direction)
		02	Enable (if command becomes negative, it outputs in a reverse direction)
PID4 deviation negative	[AJ-42]	00	Disable
		01	Enable (polarity inversion of deviation)
PID4 target value input destination	[AJ-47]	00~15	00: Disable, 01: Ai1-L input, 02: Ai2-L input, 03: Ai3-L input, 04: Ai4-L input, 05: Ai5-L input, 06: Ai6-L input, 07: Parameter setting [AH-44], 08: RS 485 communication, 09: P option 1, 10: Option 2 11: Option 3, 12: Pulse train input (main unit), 13: Pulse train input (P1-FB)
PID4 target value set value	[AJ-48]	0.00~100.00(%) *3)	Is a parameter set value.
PID4 feedback data input destination	[AJ-50]	00~13	00: Disable, 01: Ai1-L input, 02: Ai2-L input, 03: Ai3-L input, 04: Ai4-L input, 05: Ai5-L input, 06: Ai6-L input, 07: Parameter setting [AH-44], 08: RS 485 communication, 09: P option 1, 10: Option 2 11: Option 3, 12: Pulse train input (main unit), 13: Pulse train input (P1-FB)
PID4 proportional (P) gain	[AJ-53]	0.0~100.0	Proportional gain
PID4 integral (I) gain	[AJ-54]	0.0~3600.0(s)	Integral gain
PID4 differential (D) gain	[AJ-55]	0.00~100.00(s)	Differential gain

\*3) Data range varies according to [AJ-44] - [AJ-46] settings.

## ■ Input terminal function

Item	Terminal name	Data	Description
PID2 disable function	[PID2]	043	Disables the PID2 function by turning ON the terminal function. Frequency equivalent to the target value of PID2 will be commanded when the terminal is turned ON.
PID2 I control integral value clear	[PIDC2]	044	Clears the integral value of PID2 control.
PID3 disable function	[PID3]	045	Disables the PID3 function by turning ON the terminal function. Frequency equivalent to the target value of PID3 will be commanded when the terminal is turned ON.
PID3 I control integral value clear	[PIDC3]	046	Clears the integral value of PID3 control.
PID4 disable function	[PID4]	047	Disables the PID4 function by turning ON the terminal function. Frequency equivalent to the target value of PID4 will be commanded when the terminal is turned ON.
PID4 I control integral value clear	[PIDC4]	048	Clears the integral value of PID4 control.
PID output switch 1	[PIO1]	056	Switches PID output by a combination of PIO1 and PIO2.
PID output switch 2	[PIO2]	057	

■ Data monitor function

Item	Parameter	Data	Description
PID2 target value	[FA-36]	-100.00~100.00(%) *1)	Displays the target value of PID2. Changeable when [AJ-07] = 09.
PID2 feedback monitor	[db-36]	-100.00~100.00(%) *1)	Displays the feedback value of PID2.
PID2 output monitor	[db-55]	-100.00~100.00(%) *1)	Displays the output value of PID2.
PID2 deviation monitor	[db-56]	-200.00~200.00(%) *1)	Displays the deviation of PID2.
PID3 target value	[FA-38]	-100.00~100.00(%) *2)	Displays the target value of PID3. Changeable when [AJ-27] = 09.
PID3 feedback monitor	[db-38]	-100.00~100.00(%) *2)	Displays the feedback value of PID3.
PID3 output monitor	[db-57]	-100.00~100.00(%) *2)	Displays the output value of PID3.
PID3 deviation monitor	[db-58]	-200.00~200.00(%) *2)	Displays the deviation of PID3.
PID4 target value	[FA-40]	-100.00~100.00(%) *3)	Displays the target value of PID4. Changeable when [AJ-47] = 09.
PID4 feedback monitor	[db-40]	-100.00~100.00(%) *3)	Displays the feedback value of PID4.
PID4 output monitor	[db-59]	-100.00~100.00(%) *3)	Displays the output value of PID4.
PID4 deviation monitor	[db-60]	-200.00~200.00(%) *3)	Displays the deviation of PID4.

\*1) Data range varies according to [AJ-04] - [AJ-06] settings.

\*2) Data range varies according to [AJ-24] - [AJ-26] settings.

\*3) Data range varies according to [AJ-44] - [AJ-46] settings.



■ Adjust PID2/PID3/PID4 control



- When response is not stabilized in PID function operation, adjust according to the following procedure.
- Adjust respective PID gains for each PID2/PID3/PID4.



- If acceleration/deceleration time is set too long, following of output frequency will be delayed and control may not be successful. In this case, set the acceleration/deceleration time short.

Phenomenon ▶	Examples of measures
<ul style="list-style-type: none"> <li>• Output response is slow and feedback value does not change swiftly even if PID target value was changed.</li> </ul>	<ul style="list-style-type: none"> <li>• Increase PID proportional gain according to the correspondence table [1].</li> </ul>
<ul style="list-style-type: none"> <li>• Feedback value changes swiftly and is not stabilized.</li> <li>• Overshooting or hunting occurs.</li> </ul>	<ul style="list-style-type: none"> <li>• Decrease PID proportional gain according to the correspondence table [1].</li> </ul>
<ul style="list-style-type: none"> <li>• Feedback value vibrates mildly.</li> <li>• t takes time for operation to be stabilized.</li> </ul>	<ul style="list-style-type: none"> <li>• Increase PID integral gain according to the correspondence table [2].</li> </ul>
<ul style="list-style-type: none"> <li>• PID target value and feedback value do not match easily.</li> </ul>	<ul style="list-style-type: none"> <li>• Decrease PID integral gain according to the correspondence table [2].</li> </ul>
<ul style="list-style-type: none"> <li>• Response is slow even if proportional gain was increased.</li> <li>• Small hunting occurs.</li> </ul>	<ul style="list-style-type: none"> <li>• Increase PID differential gain according to the correspondence table [3].</li> </ul>
<ul style="list-style-type: none"> <li>• Response due to disturbance is large and it takes time until stabilization.</li> </ul>	<ul style="list-style-type: none"> <li>• Decrease PID differential gain according to the correspondence table [3].</li> </ul>

• Gain correspondence table

	[1] Proportional gain	[2] Integral gain	[3] Differential gain
PID2	[AJ-13]	[AJ-14]	[AJ-15]
PID3	[AJ-33]	[AJ-34]	[AJ-35]
PID4	[AJ-53]	[AJ-54]	[AJ-55]

■ PID2/PID3/PID4 changeable range limitation



- PID output is restricted to a changeable range based on the target value.
- The limitation function of PID for which 0.00 was set for the following changeable range will be disabled.



- In the case of using this function, set the corresponding PID changeable range ([AJ/16]/[AJ-36]/[AJ-56]). Restriction will be set with the maximum speed as 100% (PID target value ± changeable range).

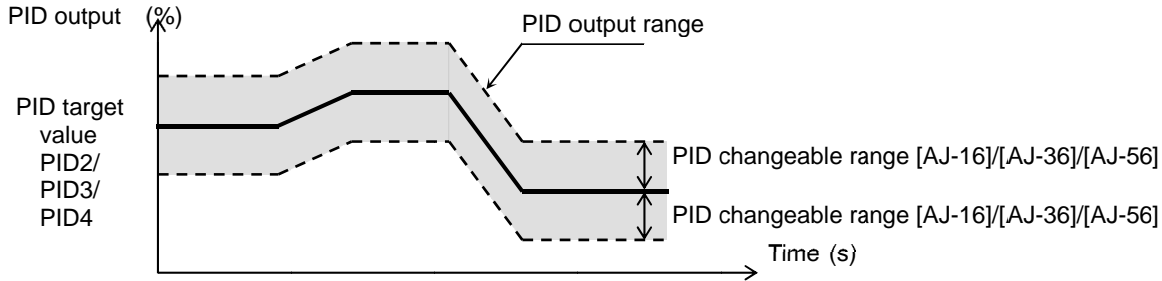

■ Parameter

Item	Terminal name	Data	Description
PID2 changeable range	[AJ-16]	0.00~100.00(%)	Changeable range based on PID2 target value
PID3 changeable range	[AJ-36]	0.00~100.00(%)	Changeable range based on PID3 target value
PID4 changeable range	[AJ-56]	0.00~100.00(%)	Changeable range based on PID4 target value

■ PID2/PID3/PID4 reverse output



- In normal PID control, the inverter does not output a negative figure for frequency command and limits at 0 Hz. If you select 02 (with reverse output) for each selection [AJ-01]/[AJ-21]/[AJ-41] of PID2/PID3/PID4, frequency command can be output in a reverse direction, if the result of the corresponding PID calculation was negative.



- When [AJ-01]/[AJ-21]/[AJ-41] is set to 02 (with reverse output), the PID changeable range limit function [AJ-16]/[AJ-36]/[AJ-56] will be extended to the negative direction.

■ Parameter

Item	Terminal name	Data	Description
PID2 selection	[AJ-01]	02	Enable (if command becomes negative, it outputs in a reverse direction)
PID3 selection	[AJ-21]		
PID4 selection	[AJ-41]		

■ PID2/PID3/PID4 I control integral reset function [PIDC2]/[PIDC3]/[PIDC4]



- This is a function to clear an integral figure of the corresponding PID operation.
- In the case of turning ON the [PIDC2]/[PIDC3]/[PIDC4] terminal, do so when the corresponding PID is not in operation.



- Turning ON the [PIDC2]/[PIDC3]/[PIDC4] terminal during PID operation clears the integral value added to the PID output command and changes the PID output command value abruptly, resulting in an over-current error.

■ PID2/PID3/PID4 disable function [PID2]/[PID3]/[PID4]



- Turning ON the corresponding terminal disables PID operation temporarily and performs output according to frequency command.

- The input value as PID command will be adopted for frequency command.

12.10.6 PID Signal Output

■ PID deviation excessive

**A**

- This outputs a deviation excessive signal in the case of each PID deviation exceeding the set level of the corresponding PID.

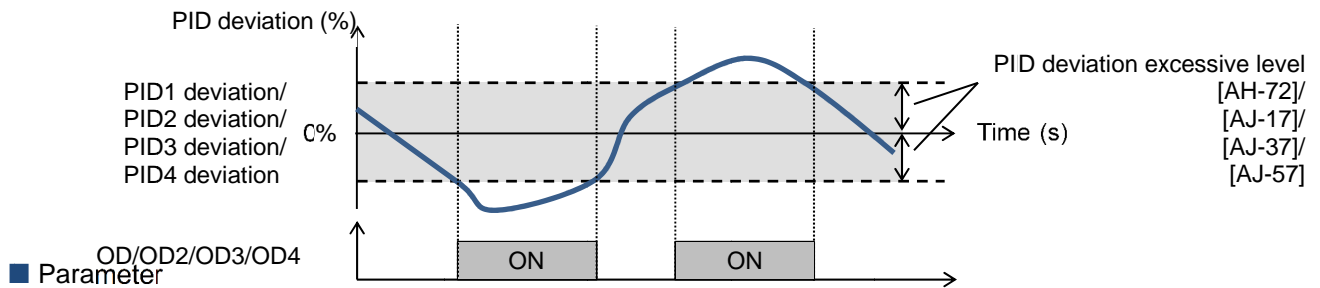

Item	Terminal name	Data	Description
PID1 deviation excessive level	[AH-72]	0.00~100.00(%)	045 [OD] signal output judgment level
PID2 deviation excessive level	[AJ-17]	0.00~100.00(%)	047 [OD2] signal output judgment level
PID3 deviation excessive level	[AJ-37]	0.00~100.00(%)	089 [OD3] signal output judgment level
PID4 deviation excessive level	[AJ-57]	0.00~100.00(%)	091 [OD4] signal output judgment level

■ Output signal function

Item	Terminal name	Data	Description
PID1 deviation excessive signal	OD	045	Signal will be turned ON when the difference between PID target value and feedback value exceeds the range of PID1 deviation excessive level.
PID2 deviation excessive signal	OD2	047	Signal will be turned ON when the difference between PID target value and feedback value exceeds the range of PID2 deviation excessive level.
PID3 deviation excessive signal	OD3	089	Signal will be turned ON when the difference between PID target value and feedback value exceeds the range of PID3 deviation excessive level.
PID4 deviation excessive signal	OD4	091	Signal will be turned ON when the difference between PID target value and feedback value exceeds the range of PID4 deviation excessive level.

**PID feedback signal**



- Output terminal signal will be turned OFF when each PID feedback reaches beyond respective PID set ranges.



- Set PID1 feedback to be OFF level  $\geq$  ON level. OFF operation will be prioritized when it is set to Off level  $<$  ON level.
- Setting ON level/OFF level to be other than 0.00 starts outputting of a feedback comparison signal.

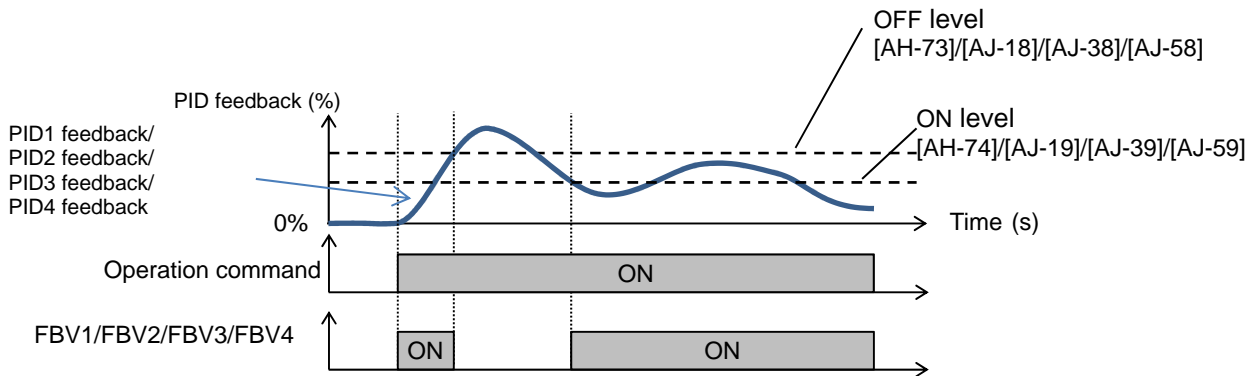

**Parameter**

Item	Terminal name	Data	Description
PID1 feedback comparison signal OFF level	[AH-73]	0.00~100.00(%)	FBV1 signal output OFF judgment level
PID1 feedback comparison signal ON level	[AH-74]	0.00~100.00(%)	FBV1 signal output ON judgment level
PID2 feedback comparison signal OFF level	[AJ-18]	0.00~100.00(%)	FBV2 signal output OFF judgment level
PID2 feedback comparison signal ON level	[AJ-19]	0.00~100.00(%)	FBV2 signal output ON judgment level
PID3 feedback comparison signal OFF level	[AJ-38]	0.00~100.00(%)	FBV3 signal output OFF judgment level
PID3 feedback comparison signal ON level	[AJ-39]	0.00~100.00(%)	FBV3 signal output ON judgment level
PID4 feedback comparison signal OFF level	[AJ-58]	0.00~100.00(%)	FBV4 signal output OFF judgment level
PID4 feedback comparison signal ON level	[AJ-59]	0.00~100.00(%)	FBV4 signal output ON judgment level

**Feedback comparison signal**

Item	Terminal name	Data	Description
PID1 feedback comparison signal	[FBV1]	046	PID1 feedback signal [FBV1] OFF: Exceeded the OFF level. ON: Went below the ON level.
PID2 feedback comparison signal	[FBV2]	048	PID2 feedback signal [FBV2] OFF: Exceeded the OFF level. ON: Went below the ON level.
PID3 feedback comparison signal	[FBV3]	090	PID3 feedback signal [FBV3] OFF: Exceeded the OFF level. ON: Went below the ON level.
PID4 feedback comparison signal	[FBV4]	092	PID4 feedback signal [FBV4] OFF: Exceeded the OFF level. ON: Went below the ON level.

### 12.10.7 PID Unit Change

■ Unit change of target value and feedback value

#### A

- This function enables to change the unit and scale of the following parameters.

■ PID1 display conversion parameter

Item	Parameter
PID1 target value 1	[FA-30]
PID1 target value 2	[FA-32]
PID1 feedback monitor 1	[db-30]
PID1 feedback monitor 2	[db-32]
PID1 target value 1 set value	[AH-10]
PID1 multi-layer target value1 to 15	[AH-12]~[AH-40]
PID1 target value 2 set value	[AH-44]

■ PID2 display conversion parameter

Item	Parameter
PID2 target value	[FA-36]
PID2 feedback monitor	[db-36]
PID2 target value set value	[AJ-10]

■ PID3 display conversion parameter

Item	Parameter
PID3 target value	[FA-38]
PID3 feedback monitor	[db-38]
PID3 target value set value	[AJ-30]

■ PID4 display conversion parameter

Item	Parameter
PID4 target value	[FA-40]
PID4 feedback monitor	[db-40]
PID4 target value set value	[AJ-50]

Adjustment example 1) If you want to display 0 to 10V (0 to 100%) as 0.1 to 0.5kPa in [db-30] when the voltage is feed-backed to the analog input 1 [Ai1]

- Unit [AH-03] = 56 (kPa), decimal point position [AH-06] = 02, zero point [AH-04] = 10, end point [AH-05] = 50

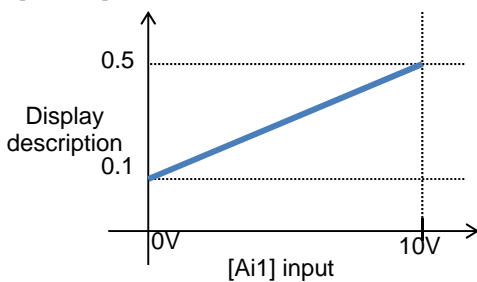

- In this setting, display descriptions of zero point and maximum point are set.
- An adjustment example is displayed at the bottom of this section.

■ Unit table

No.	Unit
00	non
01	%
02	A
03	Hz
04	V
05	kW
06	W
07	hr
08	s
09	kHz
10	ohm
11	mA
12	ms
13	P
14	kgm <sup>2</sup>
15	pls
16	mH
17	Vdc
18	°C
19	kWh
20	mF
21	mVs/rad
22	Nm
23	min <sup>-1</sup>
24	m/s
25	m/min
26	m/h
27	ft/s
28	ft/min
29	ft/h
30	m

No.	Unit
31	cm
32	°F
33	l/s
34	l/min
35	l/h
36	m <sup>3</sup> /s
37	m <sup>3</sup> /min
38	m <sup>3</sup> /h
39	kg/s
40	kg/min
41	kg/h
42	t/min
43	t/h
44	gal/s
45	gal/min
46	gal/h
47	ft <sup>3</sup> /s
48	ft <sup>3</sup> /min
49	ft <sup>3</sup> /h
50	lb/s
51	lb/min
52	lb/h
53	mbar
54	bar
55	Pa
56	kPa
57	PSI
58	mm

Adjustment example 2) If you want to display -10 to 10V (-100 to 100%) as 0.1 to 0.5kPa in [db-30] when the voltage is feed-backed to the analog input 3 [Ai3]

- Unit [AH-03] = 56 (kPa), decimal point position [AH-06] = 02, zero point [AH-04] = 30, end point [AH-05] = 50

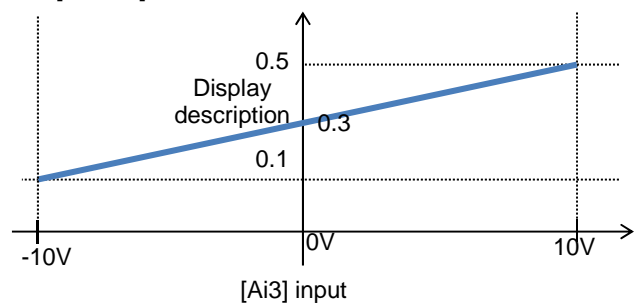

## ■ Parameter

Item	Parameter	Data	Description
PID1 unit selection	[AH-03]	* Refer to the unit table in the previous section	Sets the unit of PID1 display conversion parameter.
PID1 scale adjustment (0%)	[AH-04]	-10000~10000	Sets the criteria of input 0% of PID1 display conversion parameter.
PID1 scale adjustment (100%)	[AH-05]	-10000~10000	Sets the criteria of input 100% of PID1 display conversion parameter.
PID1 data decimal point position	[AH-06]	00	00000.
		01	0000.0
		02	000.00
		03	00.000
		04	0.0000
PID2 unit selection	[AJ-03]	* Refer to the unit table in the previous section	Sets the unit of PID2 display conversion parameter.
PID2 scale adjustment (0%)	[AJ-04]	-10000~10000	Sets the criteria of input 0% of PID2 display conversion parameter.
PID2 scale adjustment (100%)	[AJ-05]	-10000~10000	Sets the criteria of input 100% of PID2 display conversion parameter.
PID2 data decimal point position	[AJ-06]	00	00000.
		01	0000.0
		02	000.00
		03	00.000
		04	0.0000
PID3 unit selection	[AJ-23]	* Refer to the unit table in the previous section	Sets the unit of PID3 display conversion parameter.
PID3 scale adjustment (0%)	[AJ-24]	-10000~10000	Sets the criteria of input 0% of PID3 display conversion parameter.
PID3 scale adjustment (100%)	[AJ-25]	-10000~10000	Sets the criteria of input 100% of PID3 display conversion parameter.
PID3 data decimal point position	[AJ-26]	00	00000.
		01	0000.0
		02	000.00
		03	00.000
		04	0.0000
PID4 unit selection	[AJ-43]	* Refer to the unit table in the previous section	Sets the unit of PID4 display conversion parameter.
PID4 scale adjustment (0%)	[AJ-44]	-10000~10000	Sets the criteria of input 0% of PID4 display conversion parameter.
PID4 scale adjustment (100%)	[AJ-45]	-10000~10000	Sets the criteria of input 100% of PID4 display conversion parameter.
PID4 data decimal point position	[AJ-46]	00	00000.
		01	0000.0
		02	000.00
		03	00.000
		04	0.0000



## 12.11 Control Torque Based on Loading

### 12.11.1 Speed Control and Torque Control

**A**

- There are several ways to control the motor torque by having the inverter output as follows:
  - Speed control: A method of output control by having the motor speed follow a certain frequency command and sending torque at a certain speed, and
  - Torque control: A method of output control by changing the speed so that output torque follows a certain command torque.
- In the case of controlling by torque command, 08: Sensorless vector control and 10: Sensor vector control need to be selected in the [AA121] control method.
- The torque limit function in speed control can be used for 08: Sensorless vector control and 09: Sensorless vector control in the zero speed area and 10: Sensor vector control in the [AA121] control method. In the zero speed area of 09: Sensorless vector control in the zero speed area, however, control to send torque is prioritized.

Control method	Speed control	Torque control
Control target	Control is done to maintain the motor speed per frequency command.	Control is done to output the motor torque per torque command.
Operation	Output will be controlled to maintain the speed when loading is changed. If loading becomes bigger, control will be done to send a larger torque. When loading becomes smaller, control will be done to send a smaller torque.	When loading is changed, output will be controlled to maintain the torque. If loading becomes bigger, control will be done to maintain the torque by raising the speed, etc. If loading becomes smaller, control will be done to maintain the torque by slowing the speed, etc.



**12.11.2** Set Response Gain of Motor Control

**Q**

- We want to switch the response of motor control by situation.
- We want to change the speed response by speed.
- When winding, we want to change the response gain by speed that changes by diameter.
- We want to set the gain based on the speed because inertia changes by speed.

**A**

- This switches control gain (ASR gain) of motor control.
- In the control gain switch function, two types of PI gains are switched and applied by turning ON and OFF the input terminal function [CAS].

■ When [CAS] terminal switch [HA120] = 00

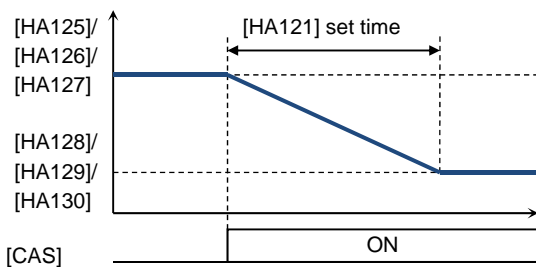

**!**

- If switching is done by the [PPI] terminal when the control gain mapping function is used, [HA130] of gain mapping P control P gain 2 will be applied.
- In the case of using this function, sensorless vector control, sensorless vector control in the zero speed area, and sensor vector control need to be selected in the [AA121] control method.
- In the case of using this function in SM (PMM) control, P gain is adopted.

- In the gain mapping function to be switched by setting, setting multiple control gains corresponding to the speed can change the gain with the speed change.

- The gains to be applied by switching of the [CAS] terminal are as follows.

Terminal function	[PPI]OFF	[PPI]ON
[CAS]OFF	PI control P gain 1 [HA125] PI control I gain 1 [HA126]	P control P gain 1 [HA127]
[CAS]ON	PI control P gain 2 [HA128] PI control P gain 2 [HA129]	P control P gain 2 [HA130]

■ In the case of switching by setting [HA120] = 01

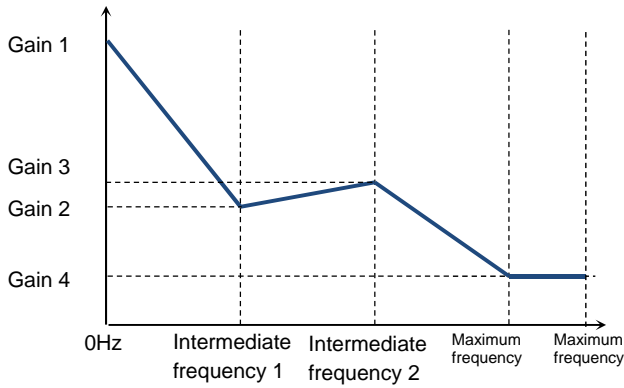

- The gains to be applied by switching of the control gain mapping function are as follows.

Speed	Applied gain	[PPI] Off	[PPI] On
Zero Hz	Gain 1	PI control P gain 1 [HA125] PI control I gain 1 [HA126]	P control P gain 1 [HA127]
Intermediate frequency 1	Gain 2	PI control P gain 2 [HA128] PI control I gain 2 [HA129]	P control P gain 2 [HA130]
Intermediate frequency 2	Gain 3	PI control P gain 3 [HA131] PI control I gain 3 [HA132]	
Maximum frequency	Gain 4	PI control P gain 4 [HA133] PI control I gain 4 [HA134]	

## ■ Parameter

Item	Parameter	Data	Description
Gain switch selection	[HA120]	00	Switches gain 1 and 2 by the [CAS] terminal.
		01	Switches by speed based on the setting.
PID1 gain switch time	[HA121]	0~10000(ms)	Switches the gain over the set time when [CAS] gain is switched.
Gain switch intermediate frequency 1	[HA122]	0.00~590.00(Hz)	Is a frequency for which the control gain 2 of the gain mapping function is applied.
Gain switch intermediate frequency 2	[HA123]	0.00~590.00(Hz)	Is a frequency for which the control gain 3 of the gain mapping function is applied.
Gain switch maximum frequency	[HA124]	0.00~590.00(Hz)	Is a frequency for the control gain 4 of the gain mapping function.
Gain mapping PI control P gain 1	[HA125]	0.0~1000.0(%)	Sets the P gain of PI control when the [CAS] terminal is OFF or the gain mapping is at zero speed.
Gain mapping PI control I gain 1	[HA126]	0.0~1000.0(%)	Sets the I gain of PI control when the [CAS] terminal is OFF or the gain mapping is at zero speed.
Gain mapping P control P gain 1	[HA127]	0.00~10.00	Sets the P gain of P control when the [CAS] terminal is OFF or the gain mapping is at zero speed.
Gain mapping PI control P gain 2	[HA128]	0.0~1000.0(%)	Sets the P gain of PI control when the [CAS] terminal is ON or the gain mapping intermediate speed is at 1.
Gain mapping PI control I gain 2	[HA129]	0.0~1000.0(%)	Sets the I gain of PI control when the [CAS] terminal is ON or the gain mapping intermediate speed is at 1.
Gain mapping P control P gain 2	[HA130]	0.00~10.00	Sets the P gain of P control when the [CAS] terminal is ON or the gain mapping intermediate speed is at 1.
Gain mapping PI control P gain 3	[HA131]	0.0~1000.0(%)	Sets the P gain of PI control when the gain mapping intermediate speed is at 2.
Gain mapping PI control I gain 3	[HA132]	0.0~1000.0(%)	Sets the I gain of PI control when the gain mapping intermediate speed is at 2.
Gain mapping PI control P gain 4	[HA133]	0.0~1000.0(%)	Sets the P gain of PI control at the gain mapping maximum speed.
Gain mapping PI control I gain 4	[HA134]	0.0~1000.0(%)	Sets the I gain of PI control at the gain mapping maximum speed.
Control gain switch	[CA-01]~[CA-11]	063	Switches gains by the [CAS] terminal.
PPI control switch		062	Switches PI control and P control by the [CAS] terminal.

12.11.3 Perform Drooping Control

**Q**

- We want to have high torque when the same axis is driven by multiple motors.

**A**

- This switches the control gain (ASR gain) of motor control from PI control to P control.
- Use the following formula when calculating P control P gain.

$$(P \text{ control P gain}) = \frac{10}{(\text{Speed fluctuation ratio})} (\%)$$

The relationship between speed fluctuation ratio and speed tolerance is calculated based on the following schematic formula.

$$(\text{Speed fluctuation ratio}) = \frac{\text{Speed tolerance at the rated torque } X(\text{min}^{-1})}{\text{Synchronous rotation at the base speed } (\text{min}^{-1})} \cdot 100\%$$

**!**

- In the case of using this function, [AA121] control method, sensorless vector control, sensorless vector control in the zero speed area, and sensor vector control need to be selected.
- When [E007] excessive voltage error occurs, the situation may be improved by setting to P control.

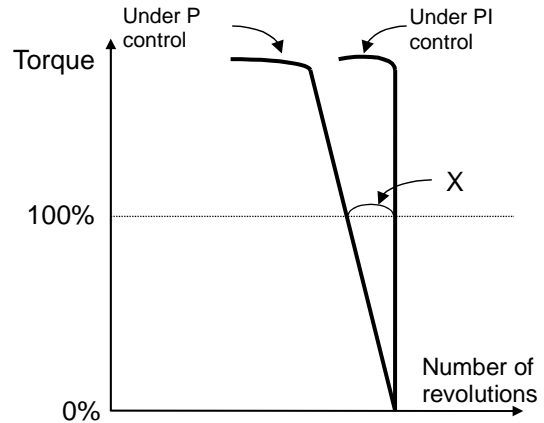

■ When [CAS] terminal switch [HA120] = 00

Terminal function	[PPI]OFF	[PPI]ON
[CAS]OFF	PI control P gain 1 [HA125] PI control I gain 1 [HA126]	P control P gain 1 [HA127]
[CAS]ON	PI control P gain 2 [HA128] PI control I gain 2 [HA129]	P control P gain 2 [HA130]

■ When the control gain mapping function [HA120] = 01

Speed	Applied gain	[PPI] Off	[PPI] On
0Hz	Gain 1	PI control P gain 1 [HA125] PI control I gain 1 [HA126]	P control P gain 1 [HA127]
Intermediate frequency 1	Gain 2	PI control P gain 2 [HA128] PI control I gain 2 [HA129]	P control P gain 2 [HA130]
Intermediate frequency 2	Gain 3	PI control P gain 3 [HA131] PI control I gain 3 [HA132]	
Maximum frequency	Gain 4	PI control P gain 4 [HA133] PI control I gain 4 [HA134]	

## ■ Parameter

Item	Parameter	Data	Description
Gain switch selection	[HA120]	00	Switches gain 1 and 2 by the [CAS] terminal.
		01	Switches by speed based on the setting.
PID1 gain switch time	[HA121]	0~10000(ms)	Switches the gain over the set time when [CAS] gain is switched.
Gain switch intermediate speed 1	[HA122]	0.00~590.00(Hz)	Is speed for which the control gain 2 of the gain mapping function is applied.
Gain switch intermediate speed 2	[HA123]	0.00~590.00(Hz)	Is speed for which the control gain 3 of the gain mapping function is applied.
Gain switch Maximum set speed	[HA124]	0.00~590.00(Hz)	Is speed for which the control gain 4 of the gain mapping function is applied.
Gain mapping PI control P gain 1	[HA125]	0.0~1000.0(%)	Sets the P gain of PI control when the [CAS] terminal is OFF or the gain mapping is at zero speed.
Gain mapping PI control I gain 1	[HA126]	0.0~1000.0(%)	Sets the I gain of PI control when the [CAS] terminal is OFF or the gain mapping is at zero speed.
Gain mapping P control P gain 1	[HA127]	0.00~10.00	Sets the P gain of P control when the [CAS] terminal is OFF or the gain mapping is at zero speed.
Gain mapping PI control P gain 2	[HA128]	0.0~1000.0(%)	Sets the P gain of PI control when the [CAS] terminal is ON or the gain mapping intermediate speed is at 1.
Gain mapping PI control I gain 2	[HA129]	0.0~1000.0(%)	Sets the I gain of PI control when the [CAS] terminal is ON or the gain mapping intermediate speed is at 1.
Gain mapping P control P gain 2	[HA130]	0.00~10.00	Sets the P gain of P control when the [CAS] terminal is ON or the gain mapping intermediate speed is at 1.
Gain mapping PI control P gain 3	[HA131]	0.0~1000.0(%)	Sets the P gain of PI control when the gain mapping intermediate speed is at 2.
Gain mapping PI control I gain 3	[HA132]	0.0~1000.0(%)	Sets the I gain of PI control when the gain mapping intermediate speed is at 2.
Gain mapping PI control P gain 4	[HA133]	0.0~1000.0(%)	Sets the P gain of PI control at the gain mapping maximum speed.
Gain mapping PI control I gain 4	[HA134]	0.0~1000.0(%)	Sets the I gain of PI control at the gain mapping maximum speed.
Control gain switch	[CA-01]~	063	Switches gains by the [CAS] terminal.
PPI control switch	[CA-11]	062	Switches PI control and P control by the [PPI] terminal.

### 12.11.4 Operation under Limitation of Torque

**Q**

- We want to limit torque not to be excessive.
- We want to perform bump control.
- We want to use as a limit switch that it stops when reached at the end of the system in torque control.
- We want to monitor the torque that the inverter limits.

**A**

- This limits torque when the speed is controlled.
- In the case of using [AA121] control method, sensorless vector control, sensorless vector control in the zero speed area, and sensor vector control, this limits output torque of the motor.
- The torque limit function is set in [bA110].
- When a torque limiting signal is selected in output selection, the output terminal 022 [TRQ] torque limiting signal will be turned ON once the torque limit function above starts operation.

**!**

- If the torque limiting function [TL] is set to an input terminal, the torque limit function set to [bA110] will be enabled, only when [TL] is turned ON. When it is OFF, the torque limit setting will be disabled and the torque limit value will be the maximum value.
- If the torque limiting function [TL] is not set to an input terminal, the torque limit function set to the torque limit selection [bA110] will be enabled constantly.
- The torque limit value [bA-11] in this function is based on the inverter output current. Therefore, output torque varies by the combination of motors. Please be aware that these are not absolute figures of torque.

#### 1. Analog input mode

- It is a mode to set a torque limit value in all operation states by applied voltage/current by setting the Ai1/Ai2/Ai3 terminal on the control terminal block in the torque limit selection [bA110].
- In the case of setting torque bias, values corresponding to analog input are as follows.

#### ■ Input to Ai1/Ai2 terminal

<b>0 to 10 (V)/0 to 20 (mA) corresponding value</b>
---

Torque command addition 0.0 to 500.0(%)
---

#### ■ Input to Ai3 terminal

<b>-10 to 10 (V) corresponding value</b>
--

Torque command addition -500.0 to 500.0(%)
--

- The setting of the ratio above can be changed by adjusting the analog input start end function. See "12.24.5 Adjust Analog Input".  
(e.g.) In the case of setting 0.0 to 50.0% to the torque command addition value for 0-10 (V)/0-20 (mA) input as [Ai1], set 10.0% for [Cb-04] to make it 50.0% against maximum 500.0%.  
([Cb-03]=0.0,[Cb-04]=10.0,[Cb-05]=0.0,[Cb-06]=10.0)

#### 2.4 Quadrant specific setting mode

- It is a mode to set respective torque limits 1 to 4 ([bA112] to [bA115]) in the four quadrants of normal powered, normal regenerative, reverse powered, and reverse regenerative.
- It will be enabled when torque limit selection [bA110] = 07 (parameter setting) and torque limit mode selection [bA111] = 00 (by each quadrant).
- The relationship of four quadrants and torque limits is shown in the figure below.

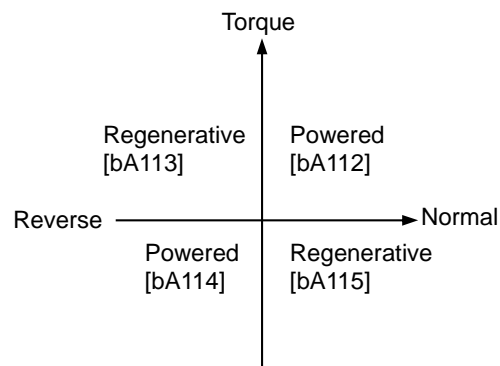

3. Terminal switch mode

- Set values of torque limits 1 to 4 ([bA112] to [bA115]) in all operation states are enabled by the combination of torque limit switch terminals 1 and 2 (TRQ1, TRQ2) set to the input terminal.
- When torque limit selection [bA110] = 07 (parameter setting) or torque limit mode selection [bA111] = 01 ([TRQ] terminal switch) is selected, torque limit 1 to 4 that can be switched by switching the torque limit switch 1/2 assigned to the input terminal will be set as shown in the figure on the right.

(e.g.) When the 061 [TRQ1] torque limit switch 1 is assigned to the input terminal 7 and the 062 [TRQ2] torque limit switch 2 to the input terminal 8

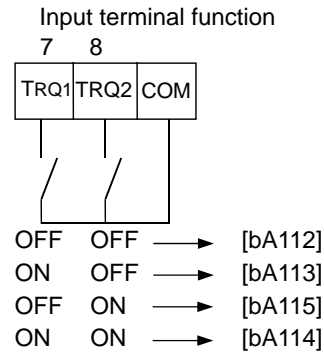

- Maintain acceleration/deceleration command of speed control when torque control is switched

**A**

- If torque pulsation occurs at the time of canceling after torque limit operation, enabling [bA116] torque LAD stop selection may be effective.

■ Parameter

Item	Parameter	Data	Description
Torque limit selection	[bA110]	00~11	00 (Disable/01)/01 (Ai1 terminal input)/02 (Ai2 terminal input)/03 (Ai3 terminal input)/04 (Ai4 terminal input)/05 (Ai5 terminal input)/06 (Ai6 terminal input)/07 (Parameter setting)/08 (RS 485)/09 (Option 1)/10 (Option 2)/11 (Option 3)
Torque limit parameter mode selection	[bA111]	00	Four Quadrant specific
		01	[TRQ] terminal switch
Torque limit 1 Torque limit 2 Torque limit 3 Torque limit 4	[bA112] [bA113] [bA114] [bA115]	0.0~500.00(%)	The torque limit function will operate when output torque exceeds this set value.
Torque LAD stop selection	[bA116]	00	Disable
		01	Enable: retains frequency information when the torque limit is switched. (at the time of deceleration operation)

■ Input terminal function [CA-01] to [CA-11]

Item	Terminal name	Data	Description
Enable/disable torque limit	[TL]	060	Switches enable/disable of the torque limit function.
Torque limit switch 1	[TRQ1]	061	Is the torque limit command switch terminal 1.
Torque limit switch 2	[TRQ2]	062	Is the torque limit command switch terminal 2.

■ Output terminal [CC-01] to [CC-07]

Item	Terminal name	Data	Description
Under torque limit	[TRQ]	022	Signal turns ON when the torque limit function is enabled.

■ Emit a signal when torque rises or drops

**A**

- The output terminal 019 [OTQ] over torque signal will be turned ON when the torque output value [dA-17] exceeds [CE120] to [CE123].
- In the case of using as an under torque signal, output will be feasible when the output terminal a/b [NO/NC] setting [CC-11] to [CC-17] corresponding to the output terminal function [CC-01] to [CC-07] assigned with 019 [OTQ] is switched from 00 to 01.

■ Monitor torque limit value

**A**

- You can check the torque limit value switched by selection on the [dA-16] torque limit monitor.

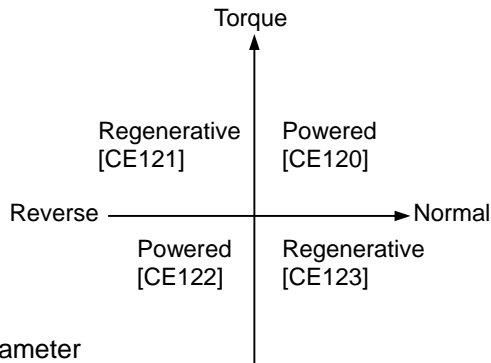

■ Parameter

Item	Parameter	Data	Description
Torque limit monitor	[dA-16]	-500.00~500.00(%)	Displays the limit value of the torque limit function.
Output torque monitor	[dA-17]	-500.00~500.00(%)	Displays the output torque.
Over torque level (normal powered)	[CE120]	0.00~500.00(%)	Turns On the [OTQ] output terminal function when the output torque exceeds respective levels.
Over torque level (reverse regenerative)	[CE121]		
Over torque level (reverse powered)	[CE122]		
Over torque level (normal regenerative)	[CE123]		

■ Output terminal [CC-01] to [CC-07]

Item	Terminal name	Data	Description
Over torque	[OTQ]	019	A signal turns ON when it exceeds the over torque level.



### 12.11.5 Send Torque from Multiple Motors

**Q**

- We want to send high torque when operating two induction motors with one inverter.
- We want to perform high torque multi-operation control.

**A**

- In the case of performing high torque multi-operation control, connect two motors with the same specification to one inverter and perform sensorless vector control (IM).
- Motor constant needs to be set as follows.

**!**

- In the case of operating different loads on two motors, the load fluctuation on one motor may influence the operation status of the other and cause inappropriate control. Make sure to operate them with a load that can be considered as one load.
- See "Chapter 12.9 Select Motor Control Method Conforming to Motor and Load" for adjustment method.

#### ■ Motor base parameter

Item	Parameter	Data	Description
Motor capacity selection	[Hb102]	0.01~160.00 (kW)	Sets a 2-fold capacity of a motor in high torque multi-operation.
Selection of number of motor poles	[Hb103]	2 to 48 (poles)	Sets the number of poles per motor.
Base frequency	[Hb104]	1.00~590.00 (Hz)	Sets the base frequency per motor.
Maximum frequency	[Hb105]	1.00~590.00 (Hz)	Sets the maximum frequency per motor.
Motor rated voltage	[Hb106]	1~1000 (V)	Sets the rated voltage per motor.
Motor rated current	[Hb108]	0.01~10000.00(A)	Sets a 2-fold rated current of a motor in high torque multi-operation.

#### ■ IM motor constant parameter

Item	Parameter	Data	Description
Motor constant R1	[Hb110]	0.000001~1000.000000( $\Omega$ )	Sets half of primary resistance of a motor in high torque multi-operation.
Motor constant R2	[Hb112]	0.000001~1000.000000( $\Omega$ )	Sets half of secondary resistance of a motor in high torque multi-operation.
Motor constant L	[Hb114]	0.000001~1000.0000000(mH)	Sets half of leaked inductance value of a motor in high torque multi-operation.
Motor constant I0	[Hb116]	0.01~10000.00(A)	Sets a 2-fold non-load current value of a motor in high torque multi-operation.
Motor constant J	[Hb118]	0.00001~10000.000000( $\text{kgm}^2$ )	Sets a 2-fold system inertia moment of a motor in high torque multi-operation.

#### ■ Parameter

Item	Parameter	Data	Description
Control method	[AA121]	08: Sensorless vector control (IM) 09: Sensorless vector control in zero speed area (IM)	Uses the sensorless vector control function or sensorless vector control in the zero speed area.

### 12.11.6 Operate by Adding Torque Command

#### Q

- We want to operate by adding torque command temporarily at the time of lifting up/down.
- We want to start-up by raising start torque command at the start of operation.

#### A

- The torque bias function operates by enabling torque bias mode selection at the time of speed control.
- The torque bias function will be enabled when the [AA121] control method is set to the sensorless vector control, sensorless vector control in the zero speed area, and sensor vector control.
- The torque bias function operates in either speed control or torque control.
- When the 068 [TBS] torque bias enable function is set to the input terminal, the torque bias function will be enabled, only when [TBS] is turned ON. When it is OFF, the torque bias setting will be disabled and the torque addition will be 0.
- In the torque bias function, switching forward/reverse can switch the adding direction.
  1. When it is per the sign [ $\pm$ ] of [Ad-14] = 00  
Regardless of the operation direction, torque will be added to the forward direction, when the torque bias value is (+), and to the reverse direction, when the torque bias is (-).
  2. When it is dependent on the operation direction [Ad-14] = 01  
The sign of torque bias value and the direction of action of torque bias change based on the direction of operation command.  
Forward command: Adds torque in the same direction as the torque bias value.  
Reverse command: Adds torque in the reverse direction as the torque bias value.



- The torque bias function increases current because torque command is added.
- In the case of setting torque bias, values corresponding to analog inputs are as follows.

#### ■ Input to Ai1/Ai2 terminal

<b>0 to 10 (V)/0 to 20 (mA) corresponding value</b>
---

Torque command addition 0.0 to 500.0(%)
---

#### ■ Input to Ai3 terminal

<b>-10 to 10 (V) corresponding value</b>
--

Torque command addition -500.0 to 500.0(%)
--

- The setting of the ratio above can be changed by adjusting the analog input start end function. See "12.24.5 Adjust Analog Input".  
(e.g.) In the case of setting 0.0 to 50.0% to the torque command addition value for 0-10 (V)/0-20 (mA) input as [Ai1], set 10.0% for [Cb-04] to make it 50.0% against maximum 500.0%.  
([Cb-03]=0.0,[Cb-04]=10.0,[Cb-05]=0.0,[Cb-06]=10.0)

■ Monitor torque bias command value

- Commanded torque bias value can be monitored on the [FA-16] torque bias monitor.
- In the case of [Ad-11] = 07, the setting can be changed on the [FA-16] monitor.

- The torque command monitor (after calculation) [dA-15] displays the value with torque bias added to the present torque command.

■ Parameter

Item	Parameter	Data	Description
Torque bias input selection	[Ad-11]	01~13,15	00 (Disable)/ 01 (Ai1 terminal input)/02 (Ai2 terminal input)/ 03 (Ai3 terminal input)/04 (Ai4 terminal input: P1-AG)/ 05 (Ai5 terminal input: P1-AG)/ 06 (Ai6 terminal input: P1-AG)/ 07 (Parameter setting)/08 (RS 485)/ 09 (Option 1)/10 (Option 2)/ 11 (Option 3)/12 (Pulse train input: main unit)/ 13 (Pulse train input: P1-FB)/15 (PID calculation)
Torque bias setting	[Ad-12]	-500.0~500.0(%)	Adds a torque addition amount.
Torque bias polarity selection	[Ad-13]	00 (Per sign)	Regardless of the operation direction, torque will be added to the forward direction, when the value is (+), and to the reverse direction, when the the value is (-).
		01 (Follow the revolution direction)	Changes the sign of the value and the the direction of torque bias action into the operation command.
Torque bias enable terminal [TBS] selection	[Ad-14]	00	Disable
		01	Enable
Torque bias monitor	[FA-16]	-500.00~500.00(%)	Is the torque bias set monitor.
Torque command monitor (after calculation)	[dA-15]	-500.00~500.00(%)	Is the torque command monitor calculated set value and bias value.
Input terminal function	[CA-01]~[CA-11]	068	[TBS]: Can switch enable/disable of bias by the terminal ON/OFF switch when [TBS] is assigned and [Ad-11] = 01. ON: Enable/OFF: Disable

### 12.11.7 Switch Torque Control and Speed Control



- We want to perform bump control after moving objects.
- We want to use the system by switching speed control and torque control.



- If the torque command changes in a step manner when switching from speed control to torque control, the current may rise instantaneously.



- In the case of operating by switching torque control and speed control, turn ON the input terminal function 067 [ATR] function.

#### ■ Parameter

Item	Parameter	Data	Description
Speed/torque control switch time	[Ad-04]	0~1000(ms)	Switches to torque command gradually based on the set time when switching speed control to torque control.

#### ■ Input terminal function

Item	Parameter	Data	Description
Input terminal 1 to 9, A or B selection	[CA-01]~[CA-11]	067	[ATR]: Torque command input approval

12.11.8 Operate by Commanding Torque

**Q**

- We want to control as such a certain torque is applied on the motor.
- We want to perform bump control.
- We want to set a certain torque when winding.

**A**

- In the case of using [AA121] control method in sensorless vector control, sensorless vector control in the zero speed area, and sensor vector control, this drives the motor based on torque command.
- This function can be used not only in speed control/pulse train position control but also in torque control. It can also be applied to a winding machine.
- Using the torque bias function at the time of torque control adds a torque bias amount to torque command.

**!**

- Because the speed under torque control is decided by the balance with load, set [Ad-40] torque control speed limit value input selection for prevention of runaway. In the case of 07: Parameter setting, set the speed limit value setting [Ad-41]/[Ad-42].
- In the case of operating by torque control, assign 067 [ATR] to any of the input terminals. Turning ON the [ATR] terminal switches from speed control to torque control.
- Torque command handles the input value selected in the torque command setting [Ad-01] as a command.

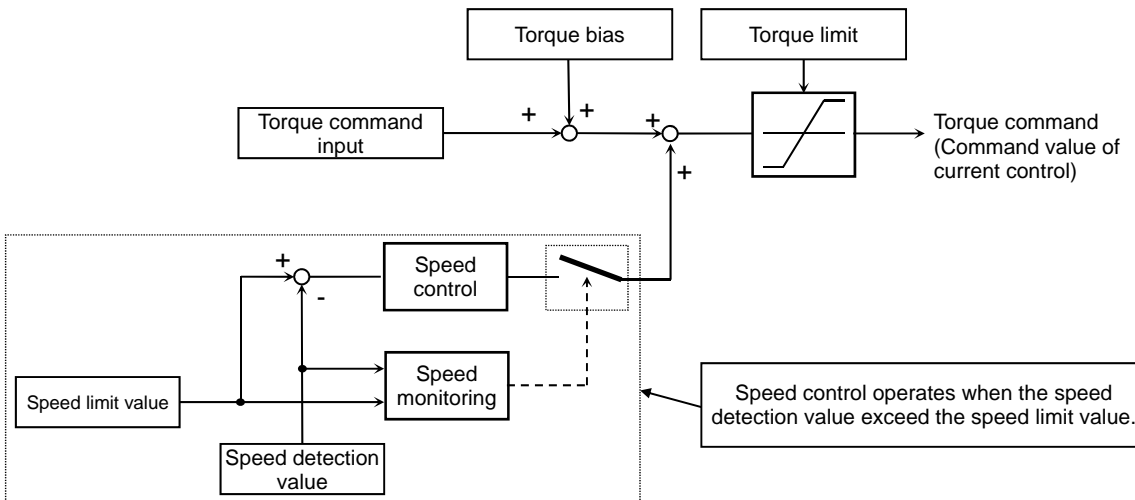

■ Parameter

Item	Parameter	Data	Description
Speed/torque control switch time	[Ad-04]	0~1000(ms)	It is time to switch from torque command to speed control. Set longer time when an error occurs at the time of switching control.
Torque control speed limit value input selection	[Ad-40]	01~13	01 (Ai1 terminal input)/02 (Ai2 terminal input)/ 03 (Ai3 terminal input)/04 (Ai4 terminal input: P1-AG)/ 05 (Ai5 terminal input: P1-AG)/ 06 (Ai6 terminal input: P1-AG)/ 07 (Parameter setting)/08 (RS 485)/ 09 (Option 1)/10 (Option 2)/ 11 (Option 3)/12 (Pulse train input: main unit)/ 13 (Pulse train input: P1-FB)
Torque control frequency limit value (for normal rotation)	[Ad-41]	0.00~590.00(Hz)	Sets frequency to limit in the normal rotation during torque control.
Torque control frequency limit value (for reverse rotation)	[Ad-42]	0.00~590.00(Hz)	Sets frequency to limit in the reverse rotation during torque control.

### ■ Monitor torque command and output torque

**A**

- The torque command monitor [FA-15] displays a current command value that has been commanded.
- In the case of [Ad-01] = 07, the torque command set value can be changed on the [FA-15] monitor.

- The torque command monitor (after calculation) [dA-15] displays the value with torque bias added to the current torque command.
- Current output torque can be monitored on the output torque monitor [FA-16].

### ■ Parameter

Item	Parameter	Data	Description
Torque command input selection	[Ad-01]	01~13,15	00 (Disable)/ 01 (Ai1 terminal input)/02 (Ai2 terminal input)/ 03 (Ai3 terminal input)/04 (Ai4 terminal input: P1-AG)/ 05 (Ai5 terminal input: P1-AG)/ 06 (Ai6 terminal input: P1-AG)/ 07 (Parameter setting)/08 (RS 485)/ 09 (Option 1)/10 (Option 2)/ 11 (Option 3)/12 (Pulse train input: main unit)/ 13 (Pulse train input: P1-FB)/15 (PID calculation)
Torque command setting	[Ad-02]	-500.0~500.0(%)	Adds a torque addition amount.
Torque command polarity selection	[Ad-03]	00 (Per sign)	Regardless of the operation direction, torque will be added to the forward direction, when the value is (+), and to the reverse direction, when the the value is (-).
		01 (Follow the revolution direction)	Changes the sign of value and the direction of torque bias action based on the operation command direction.
Torque command monitor (after calculation)	[dA-15]	-500.00~500.00(%)	It is the torque command monitor calculated set value and bias value.
Output torque monitor	[dA-17]	-500.00~500.00(%)	Displays the output torque.
Torque command monitor	[FA-15]	-500.00~500.00(%)	It is the torque command set monitor.

### ■ Input terminal function

Item	Parameter	Data	Description
Input terminal 1 to 9, A or B selection	[CA-01]~[CA-11]	067	Torque command input approval [ATR]



## 12.12 Adjusting Motor Noise, Noise, and Inverter Heat Generation

### 12.12.1 Adjusting carrier frequency



- I want to reduce the electromagnetic noise from the motor.
- I want to reduce the noise from the inverter.
- I want to suppress the heat generated in the inverter.
- I want to suppress the leakage current.



- The carrier frequency is the frequency at which the element that controls the inverter output changes.
- The carrier frequency can be changed using the [bb101] setting.
- It is also effective in avoiding resonance of mechanical systems and motors.



- With the selection using [Ub-03] Load specifications, the carrier frequency setting will be automatically restrained.
- The relation between allowable output current and carrier frequency depends on the inverter type. Derate the output current as shown in the table on the next page when increasing the carrier frequency.
- If the [AA121] control method selection when driven by induction motor (IM) is automatic torque boost (03), sensorless vector control (08), or zero speed area sensorless vector control (09), set the carrier frequency to 2.0 kHz or higher.
- If the [AA121] control method selection is the synchronous motor/permanent magnet motor (SM/PMM) sensorless vector control (11), set the carrier frequency to 8.0 kHz or higher.
- The carrier frequency should be set to 10 times or higher of the [Hb105] IM highest frequency or [Hd105] SM (PMM) highest frequency. (Ex.) When [Hb105] = 60 Hz, [bb101] = 0.6 kHz (600 Hz) or higher
- When using the carrier frequency of 2.1 kHz or higher, see the derating characteristics described in "Chapter 20 Specifications".

#### Carrier frequency and its extent of the effect

Carrier frequency	Low	High
Motor electromagnetic noise	Loud	Quiet
Noise	Quiet	Loud
Inverter heat generation	Little	Much
Leakage current	Low	High
Inverter output voltage waveform example (PWM output)	<p>Carrier frequency: Low</p>	<p>Carrier frequency: High</p>

#### Parameters

Item	Parameter	Data	Description
Carrier frequency	[bb101]	0.5~16.0(kHz) *1)	Changes the carrier frequency.

\*1) The following constraints will be applied internally.  
 Maximum 12.0 kHz at rated LD, maximum 10.0 kHz at rated VLD



### 12.12.2 Automatically lowering carrier frequency



- I want to lower the carrier frequency automatically according to the current flowing to the inverter output.
- I want to lower the carrier frequency automatically according to the inverter temperature.



- The automatic carrier frequency reduction selection can be changed using the [bb103] setting.
- The higher the inverter carrier frequency is, the more the temperature inside the inverter tends to increase.
- The Automatic carrier frequency reduction function reduces life degradation of the elements by lowering the carrier frequency automatically according to the output current or temperature.



- When the automatic carrier frequency reduction function is activated, the electromagnetic noise of the motor changes.
- If the carrier frequency [bb101] is 2.0 kHz or lower, this function will not be activated.
- The operation rate when the carrier frequency was changed during operation will be 2 kHz in 1 s.
- When the automatic carrier frequency reduction function is activated, the electromagnetic noise generated by the motor changes slowly.

#### ■ Parameters

Item	Parameter	Data	Description
Automatic carrier frequency reduction selection	[bb103]	00	[bb101] Follows the carrier frequency.
		01	Reduces the carrier frequency according to the inverter output current.
		02	Reduces the carrier frequency according to the inverter temperature.

- Output current-dependent ([bb103] = 01)
  - Carrier frequency reduction starts once the current exceeds a certain value to the rated current.
  - When the current decreases, the carrier frequency is automatically regained.

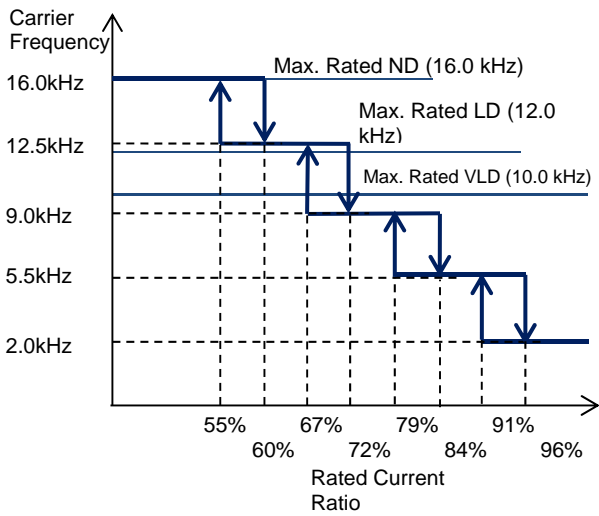

- Cooling fin temperature-dependent ([bb103] = 02)
  - Carrier frequency reduction starts once the temperature of the internal output element exceeds a certain value.
  - When the temperature lowers, the carrier frequency is automatically regained.

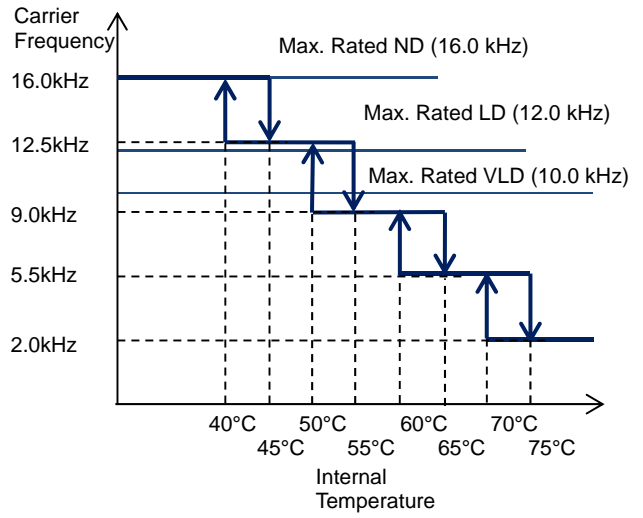

### 12.12.3 Reducing electromagnetic noise of motor



- I want to lower the electromagnetic noise of motor produced by the carrier frequency



- Sprinkle carrier pattern selection can be changed using the [bb102] setting.
- The inverter carrier frequency is about the same as when output at 3 kHz.



- Changing the sprinkle carrier pattern selection cuts the electromagnetic noise of a certain area and changes the electromagnetic noise of the motor.

#### ■ Parameters

Item	Parameter	Data	Description
Sprinkle carrier pattern selection	[bb102]	00	Disabled (Follows other carrier frequency setting)
		01	Pattern 01
		02	Pattern 02
		03	Pattern 03

## 12.13 Using Trip Avoidance Function

### 12.13.1 Restraining to avoid overloading

#### Q

- I want to lower frequency to avoid overloading.
- I want to prevent stall.
- I want to accelerate while suppressing the motor current.
- I want to prevent overcurrent tripping caused by sudden fluctuation of load.

#### A

- Set [bA122] overload limit function to any value other than 00, and the output frequency automatically lowers according to overload limit time once the output current reaches [bA123] overload limit level.
- When [bA122] = 01, the output current is monitored during acceleration or at constant speed. It limits the excess inertial moment during acceleration and overload state caused by sudden acceleration.
- When [bA122] = 02, the output current is monitored only at constant speed. It prevents overloading caused by sudden load fluctuation at constant speed without decelerating during acceleration.
- When [bA122] = 03, the output current is monitored during acceleration or at constant speed. In addition to the operation with [bA122] = 01, it accelerates to prevent overloading when regenerative load is applied at constant speed.



- Setting the overload limit operation time to be too short will cause this function to perform automatic deceleration even during acceleration, which may lead to overvoltage tripping caused by regenerative energy from the motor.
- If this function is activated during acceleration and the frequency does not reach the target frequency, the situation can be improved with the adjustments shown below.
  - Make the acceleration time longer
  - Adjust the torque boost
  - Increase the overload limit level

- [bA124] overload limit time is the time to decelerate from the maximum frequency to 0 Hz or to accelerate from 0 Hz to the maximum frequency.
- If this function is activated while the inverter is accelerating, the acceleration time will be longer than the set time.

#### ■ Operation example

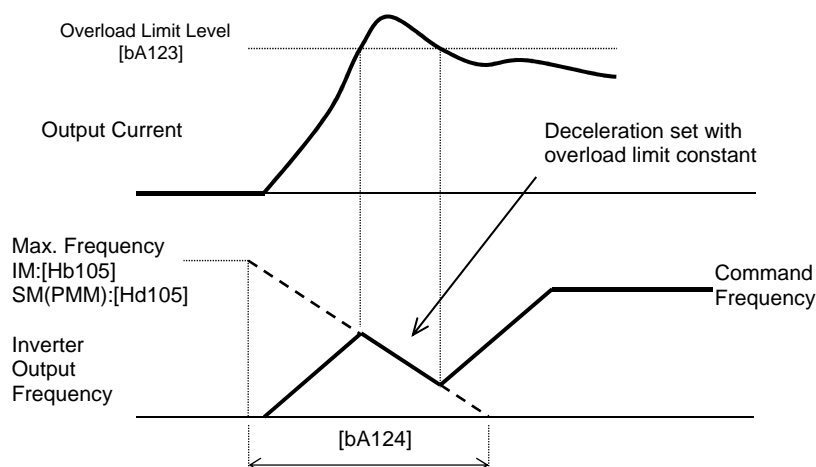

**Q**

- I want to switch the overload limit function with terminal input.
- I want to switch the overload limit level according to the load since the load weight differs from situation to situation.

**A**

- Using [bA122] to [bA124] of overload limit 1 and [bA126] to [bA128] of overload limit 2, you can set two types of overload limit functions.
- You can switch between overload limit 1 and overload limit 2 with the input terminal function 038[OLR]. Turning on the [OLR] enables the overload limit 2.

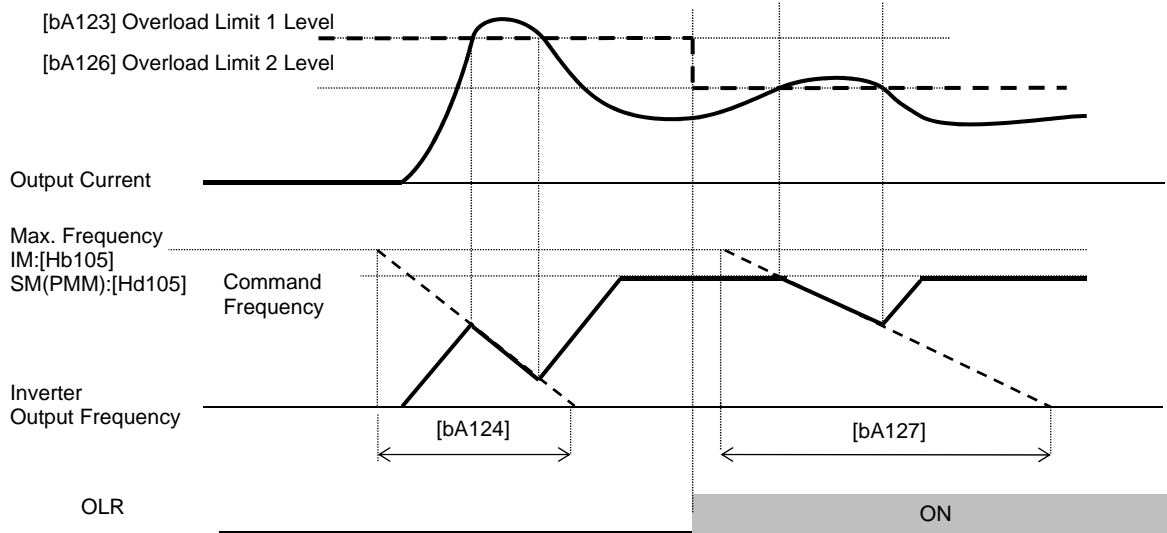

■ Parameters

Item	Parameter	Data	Description
Overload limit 1 selection Overload limit 2 selection	[bA122] [bA126]	00	Disabled
		01	Enabled during acceleration and at constant speed
		02	Enabled at constant speed
		03	Enabled during acceleration and at constant speed (Speed increases during regeneration)
Overload Limit 1 Level Overload Limit 2 Level	[bA123] [bA127]	Inverter rated current × (0.20~2.00)	Overload limit function is activated when the output current exceeds this set value.
Overload limit 1 operation time Overload limit 2 operation time	[bA124] [bA128]	0.10~3600.00(s)	Acceleration/Deceleration time when exceeded the overload limit level.

■ Input terminal function

Item	Parameter	Data	Description
Input terminal function selection	[CA-01]~[CA-11]	038	[OLR] Overload limit switching OFF: Overload limit 1 enabled. ON: Overload limit 2 enabled.

### 12.13.2 Restraining to avoid overcurrent



- Impact load can cause overcurrent tripping.
- I would like to avoid tripping against momentary current increase.
- I want to accelerate while suppressing the motor current.
- I want to prevent tripping caused by sudden fluctuation of load.



- Setting [bA120] overcurrent suppression selection to 01 enables the overcurrent suppression function.
- This function suppresses the overcurrent caused by steep current increase due to sudden acceleration, etc.



- Disable this function when using for elevators, etc. Suppressing the current causes insufficient torque, which may result in sliding down of the panier or anything hanging.
- The overcurrent tripping may take place even if this function is enabled if the current increases sharply due to shock load, etc.
- This function will be automatically enabled during DC braking.

- If the overcurrent suppression function is enabled, the overcurrent suppression function will be activated when the motor current exceeds the set value for [bA121] with momentary current increase.

#### Parameters

Item	Parameter	Data	Description
Overcurrent suppression selection	[bA120]	00	Disabled
		01	Enabled (Overcurrent suppression is activated.)
Overcurrent suppression level	[bA121]	Inverter rated current × (0.00~2.00)	Sets the operation level of the overcurrent suppression function.
Overcurrent suppression level when resuming with frequency pull-in	[bb-46]	Inverter rated current × (0.00~2.00)	Sets the operation level of the overcurrent suppression function when activated with frequency pull-in.* 1)

\*1) See "12.14.4 Starting with frequency pull-in" for details.

### 12.13.3 Controlling frequency to avoid overvoltage



- Overvoltage error is generated when the motor is decelerated.
- I want to decelerate the motor by automatically extending the deceleration time.
- I want to prevent overvoltage error by increasing the frequency when regenerative load is applied.



- [bA140] overvoltage suppression function selection allows you to enable the overvoltage suppression function.
- The overvoltage suppression function will be activated when the internal DC voltage of the inverter main circuit capacitor exceeds the value set by [bA141] overvoltage suppression level.



- When this function is enabled, the actual deceleration time may get longer than the set value.
- When using this function, it may take long time before the motor stops depending on the motor load moment of inertia.
- Depending on the deceleration rate or load status, the overvoltage tripping may be triggered even if this function is enabled.
- Set [bA141] to be receiving voltage  $\times \sqrt{2} \times 1.1$  or higher. Setting a value lower than the P-N voltage in operation may prevent the motor from stopping.

#### Parameters

Item	Parameter	Data	Description
Overvoltage suppression function	[bA140]	00	Disabled
		01	Constant DC voltage-controlled deceleration
		02	Function to avoid overvoltage acceleration (only in deceleration)
		03	Function to avoid overvoltage acceleration
Overvoltage suppression level setting	[bA141]	200 V class: 330.0 - 400.0 (V) 400 V class: 660.0 - 800.0 (V)	Sets the level at which the overvoltage suppression function starts.
Overvoltage suppression operating time	[bA142]	0.00~3600.00(s)	Acceleration time when the overvoltage suppression function is activated.
Constant DC voltage control Proportional (P) gain	[bA144]	0.00~5.00	Proportional gain for PI control in constant DC voltage control.
Constant DC voltage control Integral (I) gain	[bA145]	0.00~150.00	Integral gain for PI control in constant DC voltage control.

■ For constant DC voltage control [bA140] = 01

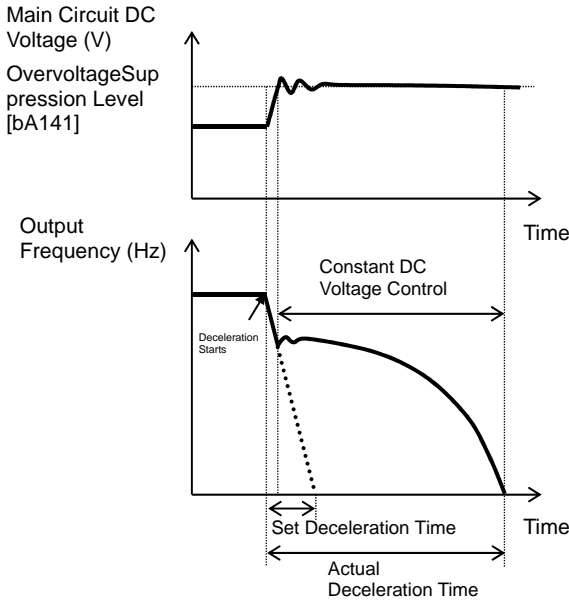

■ For function to avoid overvoltage acceleration (only in deceleration) [bA140] = 02

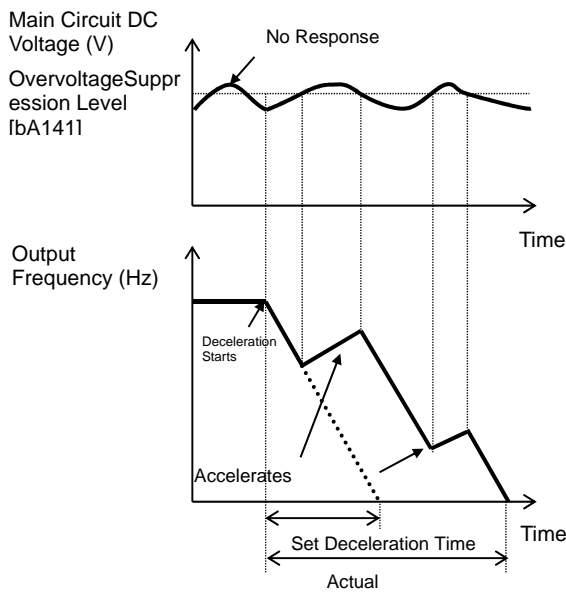

**A**

- When [bA141] is 01, PI control is performed so that the internal DC voltage will be constant.
- Setting the proportional gain [bA143] to be large will accelerate the response. However, setting it to be too large will dissipate the control, tending to cause tripping.
- Setting the integral gain [bA144] to be short will accelerate the response. However, setting it to be too short will tend to cause tripping.
- If the internal DC voltage increases when [bA141] is 02 or 03, acceleration control is performed.
- The acceleration control accelerates to the highest frequency setting according to the overvoltage suppression operating time [bA142]. After the acceleration, it decelerates to the target value according to the normal deceleration time.

**!**

- If the overvoltage suppression operating time [bA142] is set to be too short, it accelerates more than decelerating and may prevent the motor from stopping. In this case, increase the setting of the overvoltage suppression level setting [bA141].

■ For function to avoid overvoltage acceleration [bA140] = 03

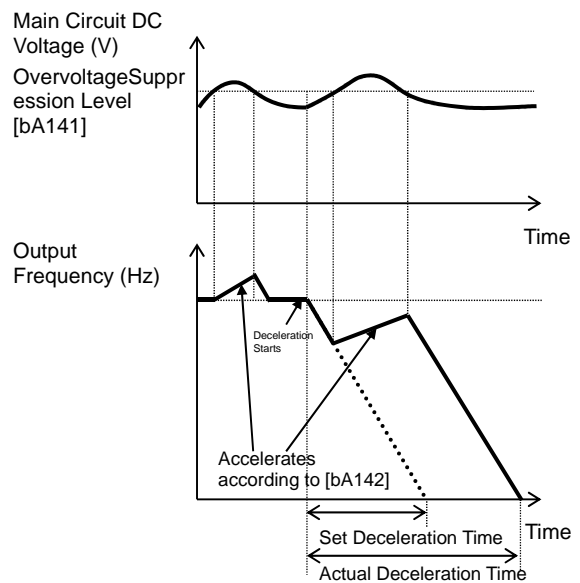



### 12.13.4 Controlling output to avoid overvoltage



- Overvoltage error is generated when the motor is decelerated.
- I want to decelerate the motor by automatically increasing the output voltage according to the regenerative energy during deceleration.
- I want to prevent overvoltage error by increasing the output voltage when regenerative load is applied.



- When this function is enabled, the current may increase as the output voltage increases.
- When using this function, the motor will be overexcited and the heat generated by the motor may increase.
- Depending on the deceleration rate or load status, the overvoltage tripping may be triggered even if this function is enabled.
- The overexcitation function is activated when controlling VC characteristics of V/f control, VP characteristics, and free V/f control.



- [bA146] overexcitation function selection allows you to enable the overexcitation function.
- The overexcitation function increases the motor loss and reduces energy to be regenerated in order to suppress the overvoltage and prevent tripping.

#### Parameters

Item	Parameter	Data	Description
Overexcitation function selection	[bA146]	00	Disabled
		01	Always active
		02	Active only during deceleration
		03	Level operation
		04	Level operation during deceleration
Overexcitation output filter time constant	[bA147]	0.00~1.00(s)	Filter time constant applied to the overexcitation output.
Overexcitation voltage gain	[bA148]	50~400(%)	Gain for the overexcitation output voltage.
Overexcitation suppression level	[bA149]	200 V class: 330.0 - 400.0 (V) 400 V class: 660.0 - 800.0 (V)	The level at which the overexcitation function starts its operation.

■ When always active [bA146] = 01

- Always activated according to the P-N voltage

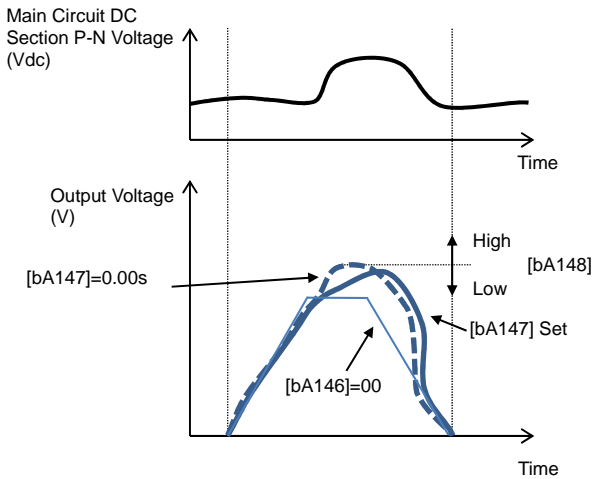

■ When activated only during deceleration [bA146] = 02

- Activated according to the P-N voltage during deceleration

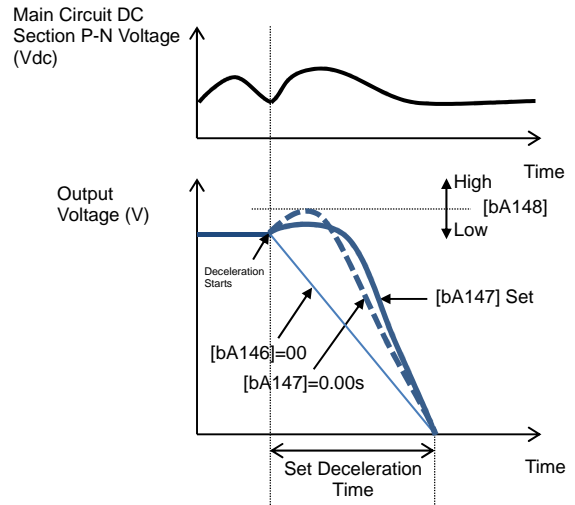

■ For level operation [bA146] = 03

- Activated when the P-N voltage exceeds the set level

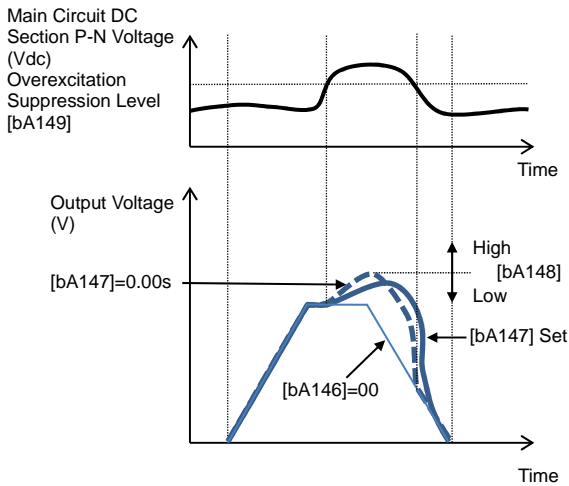

■ For level operation during deceleration [bA146] = 04

- Activated when the P-N voltage exceeds the set level only during deceleration

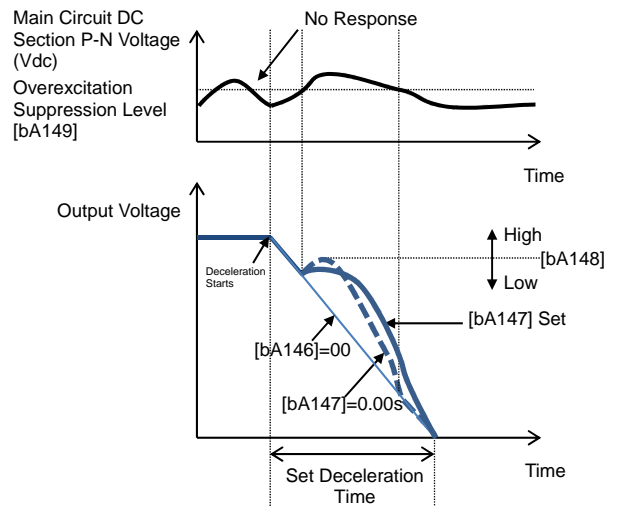

### 12.13.5 Suppressing overvoltage with braking resistor

#### Q

- Overvoltage error is generated when the motor is decelerated.
- An overvoltage error is generated due to regenerative load.
- I want to use this function to quickly decelerate the motor.
- I want to use this function for lowering.

#### A

- This is a function concerning braking circuit (BRD).
- This function is to consume the regenerative energy from the motor as heat using the external resistor.

#### ■ Operation rate

The motor will trip when the operation rate exceeds the use rate.

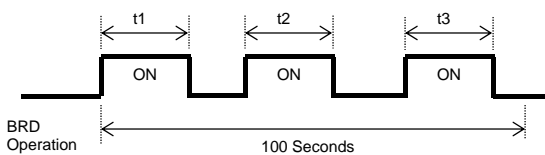

$$\text{Operation Rate (\%)} = \frac{(t1+t2+t3)}{100 \text{ Seconds}} \times 100$$

#### ■ Parameters

Item	Parameter	Data	Description
Braking resistor circuit (BRD) use rate	[bA-60]	0.0~100.0(%) *) The upper limit depends on [bA-63]	If it is set to 0.0, the BRD function will not be activated. If the setting is other than 0.0, the motor will trip when [dA-41] BRD load factor monitor exceeds the BRD use rate.
Braking resistor circuit (BRD) selection	[bA-61]	00	Disabled
		01	Enabled (Disable while being stopped)
		02	Enabled (Enabled while being stopped)
Braking resistor circuit (BRD) ON level	[bA-62]	200 V class: 330.0 - 400.0 (V) 400 V class: 660.0 - 800.0 (V)	The ON level at which the BRD is activated.
Braking resistor circuit (BRD) resistance	[bA-63]	Minimum resistance ~600 (Ω)	Setting the BRD resistance to be connected automatically sets the maximum value for [bA-60].

#### ■ Monitoring

Item	Parameter	Data	Description
BRD load factor monitor	[dA-41]	0.00~100.00(%)	The value in accordance with the BRD use rate will be displayed.



- You can also use the optional BRD unit instead of using the built-in braking circuit (BRD). If using the BRD unit, no setting needs to be made.
- The BRD ON level is the level setting for the main circuit DC smoothing capacitor inside the inverter. It needs to be set to a value exceeding the input voltage times  $\sqrt{2}$ .
- See the selection and wiring of regenerative braking resistor for minimum resistance that can be connected and BRD use rate for each model.

12.13.6 Restarting after undervoltage



- Main power was momentarily turned off due to power failure.
- I want to start the motor according to the motor rotation when restarting after undervoltage.



- You can select either tripping ([bb-21] = 00) with power supply recovery or retrying restarting ([bb-21] ≠ 00) when the main power (R, S, T) fails.
- If the input power supply to the inverter is input separately to main power supply (R, S, T) and control power supply (R0, T0), the operation depends on how the power to the main power supply (R, S, T) drops.
- When [bb-27] = 00, you can avoid undervoltage error if the main power supply is to be turned off for saving energy while the inverter output is being stopped.
- When [bb-27] = 02, you can avoid undervoltage error caused by power shutdown during deceleration and stop.



- If the input power supply to the inverter is input to the control power supply (R0, T0) via main power supply (R, S, T), instantaneous power failure tripping or instantaneous power failure retry may be triggered first depending on the operating situation.
- If the control power supply has failed completely, the action to be taken is the powering on.
- After 40 seconds with the main power supply (R, S, T) failed, the undervoltage will occur and the motor will trip even if [bb-27] = 00 or 02.
- Inverter internal P-N voltage can be monitored with [dA-40].

Parameters

Item	Parameter	Data	Description
Undervoltage retry count selection	[bb-21]	00~16/ ∞(255) (Counts)	Sets the undervoltage retry restarting counts. If this is set to 0, the motor will trip upon undervoltage.
Instantaneous power failure/undervoltage retry selection	[bb-24]	00	Restarts at 0 Hz
		01	Restarts with the frequency matching
		02	Restarts upon frequency pull-in
		03	Detection speed (frequency) <v2.00 or higher>
Instantaneous power failure/undervoltage retry standby time	[bb-26]	04	Trips after decelerating and stopping with the frequency matching
		0.3~100.0(s)	Starts after waiting for the set time upon power voltage recovery.
Instantaneous power failure/undervoltage tripping selection during stop	[bb-27]	00	Disabled
		01	Enabled
		02	Disabled during stop and deceleration stop

(Ex. 1) When [bb-21] = 00, tripping occurs

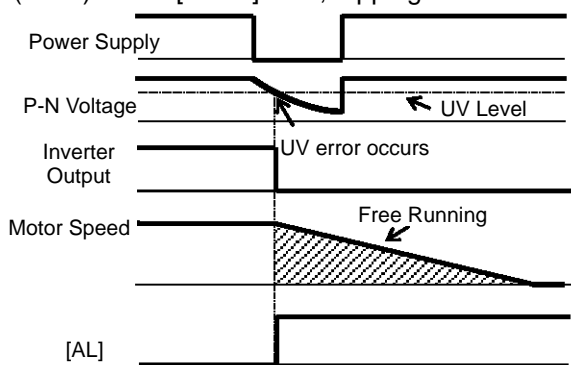

(Ex. 2) When [bb-21] ≠ 00 and [bb-24] = 00, it restarts at 0 Hz.

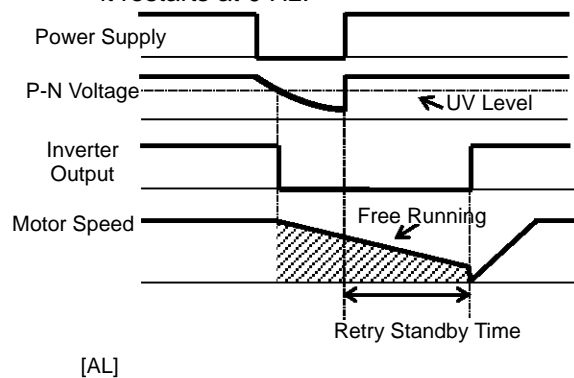

(Ex. 3) When [bb-21] ≠ 00 and [bb-24] = 01, it restarts by picking up the frequency.

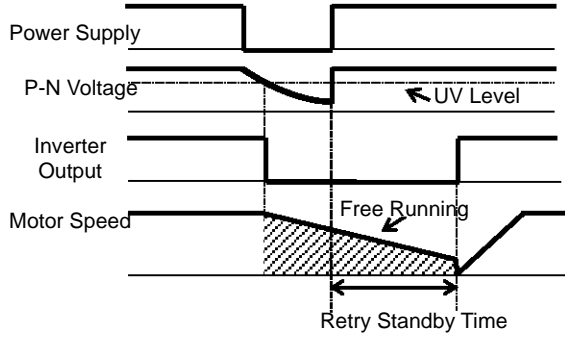

[AL]

- See "12.14.3 Starting by picking up frequency" for details.

(Ex. 4) When [bb-21] ≠ 00 and [bb-24] = 02, it restarts with frequency pull-in.

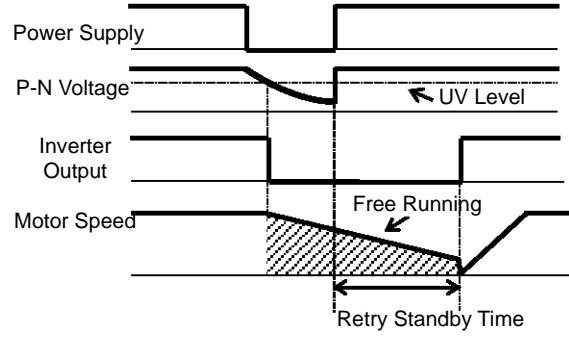

[AL]

- See "12.14.4 Starting with frequency pull-in" for details.

(Ex. 5) When [bb-21] ≠ 00 and [bb-24] = 03, it restarts using the motor speed feedback.

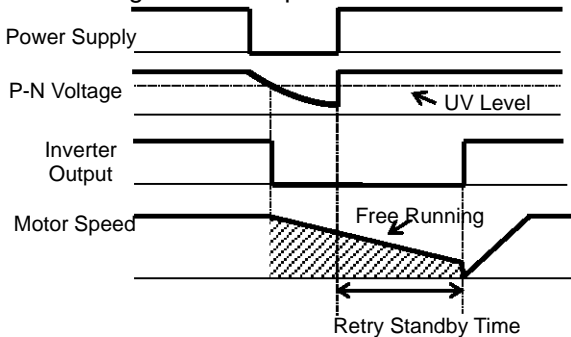

[AL]

- For motor speed feedback, the feedback input to the input terminals A and B, or feedback input to the optional cassette P1-FB is required.

(Ex. 6) When [bb-21] ≠ 00 and [bb-24] = 04, it restarts by picking up frequency, and then after deceleration according to the setting, the motor trips when stopped.

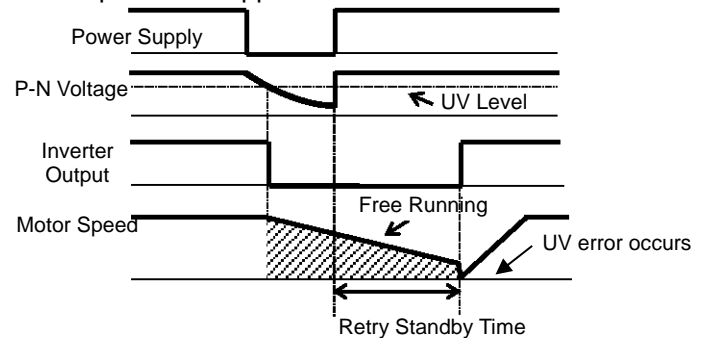

[AL]

**12.13.7** Restarting upon recovery after instantaneous power failure

**Q**

- Main power was momentarily turned off due to instantaneous power failure.
- I want to make restart setting while maintaining the control power supply in standby by inputting the P-N voltage into the control circuit.
- I want to connect a 24-V backup power supply to be able to restart even if the power supply failed.

**A**

- When the power supply shows the voltage falling short of the undervoltage level, you can select either tripping ([bb-20] = 00) by recovering the power supply or retrying restarting ([bb-20] ≠ 00).
- If the input power supply to the inverter is input separately to main power supply (R, S, T) and control power supply (R0, T0), the instantaneous power failure is detected based on how much the power to the main power supply (R, S, T) drops.
- When [bb-27] = 00, you can avoid instantaneous power failure error before the control power supply is turned off for saving energy while the inverter output is being stopped.
- When [bb-27] = 02, you can avoid instantaneous power failure error caused by power shutdown during deceleration and stop.

**!**

- The judgement of instantaneous power failure of the inverter is based on the detection of voltage drop in the main power supply (R, S, T).
- Depending on the fluctuation rate of the main power supply (R, S, T), errors other than instantaneous power failure may occur.
- If the input power supply to the inverter is input to the control power supply (R0, T0) via main power supply (R, S, T), undervoltage tripping or undervoltage retry may be triggered first depending on the operating situation.
- When the power supplied to the control power supply (R0, T0) is shut off, the power will be lost as quick as in about 80 ms. In this case, it will be a power shutdown.

**Parameters**

Item	Parameter	Data	Description
Instantaneous power failure tripping selection	[bb-20]	0~16/ ∞(255) (Counts)	Sets the retry counts in case of instantaneous power failure. If this is set to 0, the motor will trip upon recovery from instantaneous power failure.
Instantaneous power failure/undervoltage retry selection	[bb-24]	00	Restarts at 0 Hz
		01	Restarts with the frequency matching
		02	Restarts upon frequency pull-in
		03	Detection speed (frequency) <v2.00 or higher>
	04	Trips after decelerating and stopping with the frequency matching	
Instantaneous power failure allowable time	[bb-25]	0.3~25.0(s)	Restarts if the instantaneous power failure time is within the set value.
Instantaneous power failure/undervoltage retry standby time	[bb-26]	0.3~100.0(s)	Starts after waiting for the set time upon power voltage recovery.
Instantaneous power failure/undervoltage tripping selection during stop	[bb-27]	00	Disabled
		01	Enabled
		02	Disabled during stop and deceleration stop

(Ex. 1) When [bb-20] = 00, tripping occurs

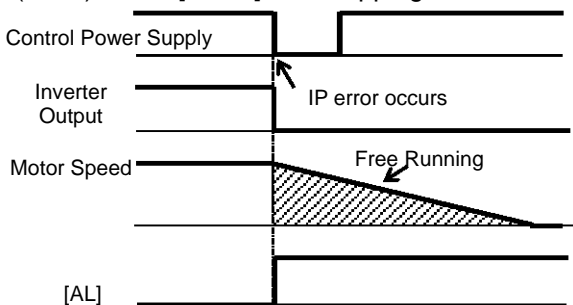

(Ex. 2) When [bb-20] ≠ 00 and [bb-24] = 00, it restarts at 0 Hz.

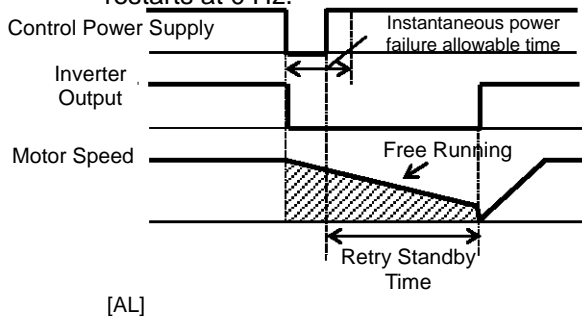

\*) The motor will trip after instantaneous power failure allowable time.

(Ex. 3) When [bb-20] ≠ 00 and [bb-24] = 01, it restarts by picking up the frequency.

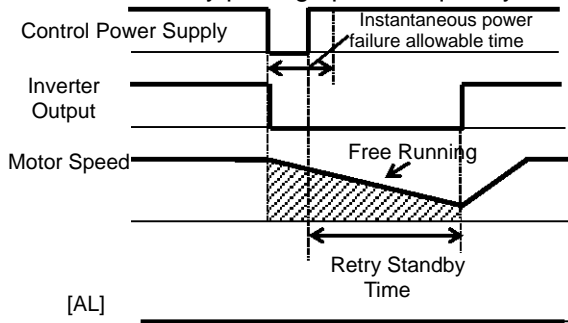

- \* ) The motor will trip after instantaneous power failure allowable time.
- See "12.14.3 Starting by picking up frequency" for details.

(Ex. 4) When [bb-20] ≠ 00 and [bb-24] = 02, it restarts with frequency pull-in.

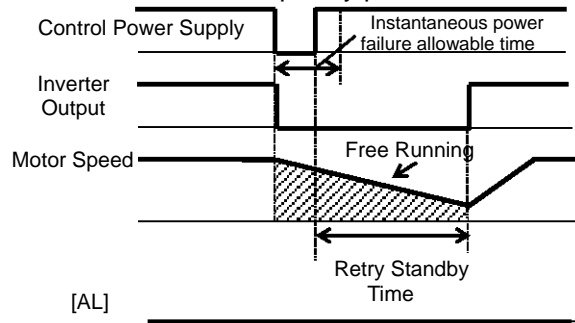

- \* ) The motor will trip after instantaneous power failure allowable time.
- See "12.14.4 Starting with frequency pull-in" for details.

(Ex. 5) When [bb-20] ≠ 00 and [bb-24] = 03, it restarts using the motor speed feedback.

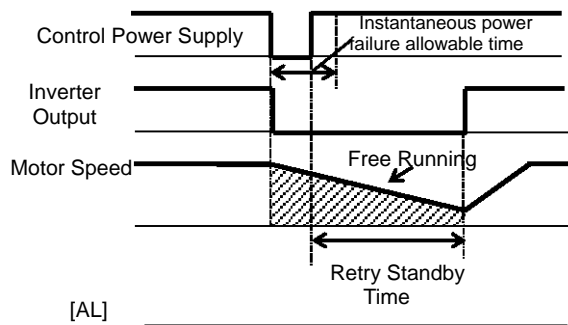

- \* ) The motor will trip after instantaneous power failure allowable time.
- For motor speed feedback, the feedback input to the input terminals A and B, or feedback input to the optional cassette P1-FB is required.

(Ex. 6) When [bb-20] ≠ 00 and [bb-24] = 04, it restarts by picking up the frequency, and then after deceleration according to the setting, the motor trips when stopped.

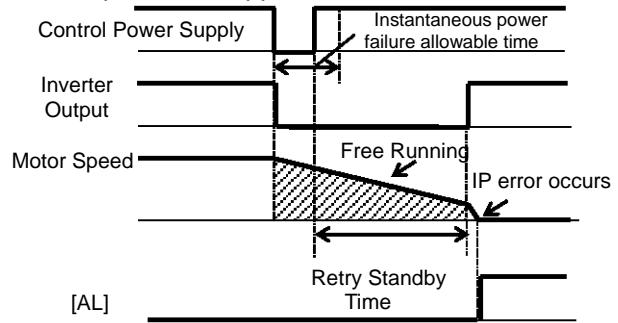

- \* ) The motor will trip after instantaneous power failure allowable time.

12.13.8 Restarting after overcurrent



- Overcurrent occurs rarely, but I want to restart continuously as it is since there is no problem in the system.
- I want the system continue to function in case of overcurrent.



- If overcurrent continues to be observed, there are some possible causes: short acceleration time, heavy load, locked motor, etc.



- In case of overcurrent, you can restart without causing tripping.

Parameters

Item	Parameter	Data	Description
Overcurrent detection level	[bb160]	Inverter ND rated current × (0.20~2.20)	Sets the level at which the overcurrent is to be detected.
Overcurrent retry count selection	[bb-22]	0~5 (Counts)	Sets the retry counts in case of overcurrent. If this is set to 0, the motor will trip upon overcurrent.
Overcurrent tripping retry selection	[bb-28]	00	Restarts at 0 Hz
		01	Restarts with the frequency matching
		02	Restarts upon frequency pull-in
		03	Detection speed (frequency) <v2.00 or higher>
		04	Trips after decelerating and stopping with the frequency matching
Overcurrent retry standby time	[bb-29]	0.3~100.0(s)	Restarts after waiting for the set time upon overcurrent.

(Ex. 1) When [bb-22] = 00, tripping occurs

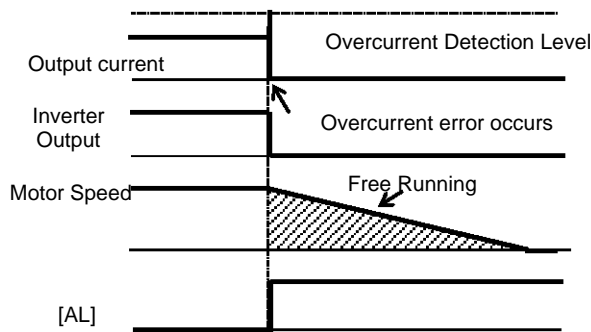

(Ex. 2) When [bb-22] ≠ 00 and [bb-28] = 00, it restarts at 0 Hz.

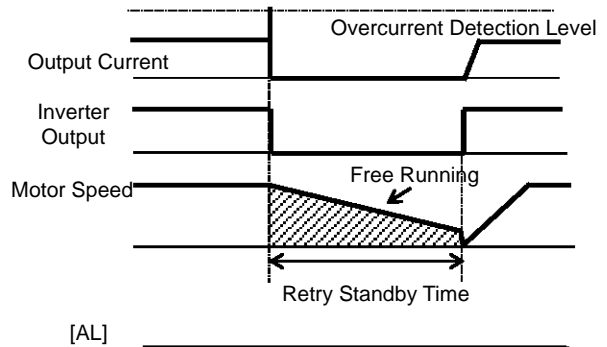



(Ex. 3) When [bb-22] ≠ 00 and [bb-28] = 01, it restarts by picking up the frequency.

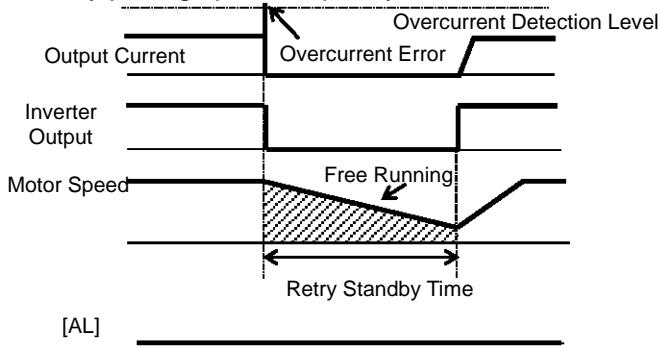

[AL]

- See "12.14.3 Starting by picking up frequency" for details.

(Ex. 4) When [bb-22] ≠ 00 and [bb-28] = 02, it restarts with frequency pull-in.

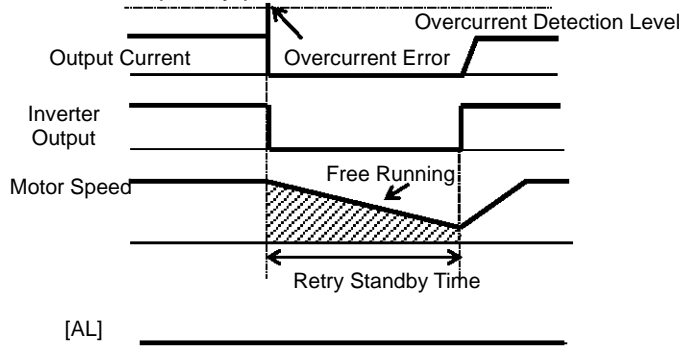

[AL]

- See "12.14.4 Starting with frequency pull-in" for details.

(Ex. 5) When [bb-22] ≠ 00 and [bb-28] = 03, it restarts using the motor speed feedback.

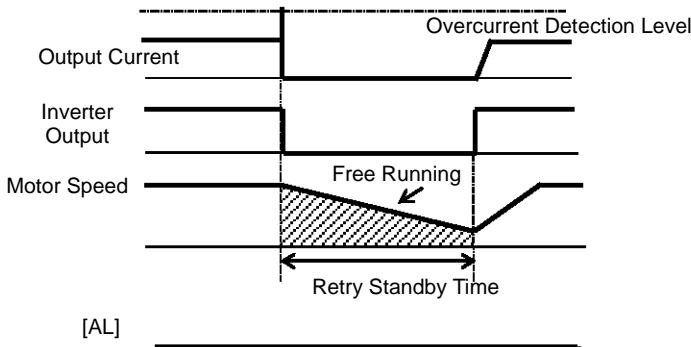

[AL]

- For motor speed feedback, the feedback input to the input terminals A and B, or feedback input to the optional cassette P1-FB is required.

(Ex. 6) When [bb-22] ≠ 00 and [bb-28] = 04, it restarts by picking up the frequency, and then after deceleration according to the setting, the motor trips when stopped.

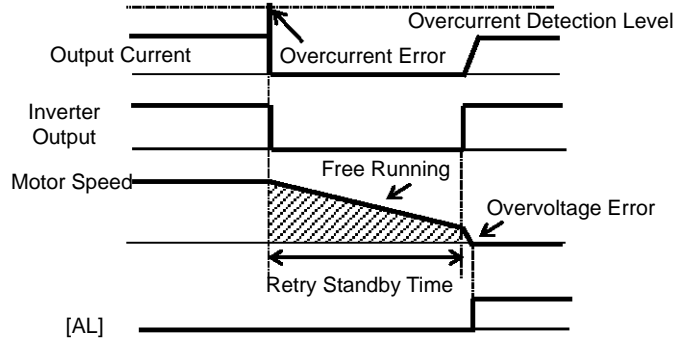

[AL]

12.13.9 Restarting after overvoltage



- Overvoltage occurs rarely, but I want to restart continuously as it is since there is no problem in the system.
- I want the system continue to function in case of overvoltage.



- If overvoltage continues to be observed, there are some possible causes: short deceleration time, heavy load, motor operated by external force, etc.



- In case of overvoltage, you can restart without causing tripping.

Parameters

Item	Parameter	Data	Description
Overvoltage tripping selection	[bb-23]	0~5 (Counts)	Sets the retry counts in case of overvoltage. If this is set to 0, the motor will trip upon overvoltage.
Overvoltage tripping retry selection	[bb-30]	00	Restarts at 0 Hz
		01	Restarts with the frequency matching
		02	Restarts upon frequency pull-in
		03	Detection speed (frequency) <v2.00 or higher>
		04	Trips after decelerating and stopping with the frequency matching
Overvoltage retry standby time	[bb-31]	0.3~100.0(s)	Restarts after waiting for the set time upon overvoltage.

(Ex. 2) When [bb-23] ≠ 00 and [bb-30] = 00, it restarts at 0 Hz.

(Ex. 1) When [bb-23] = 00, tripping occurs

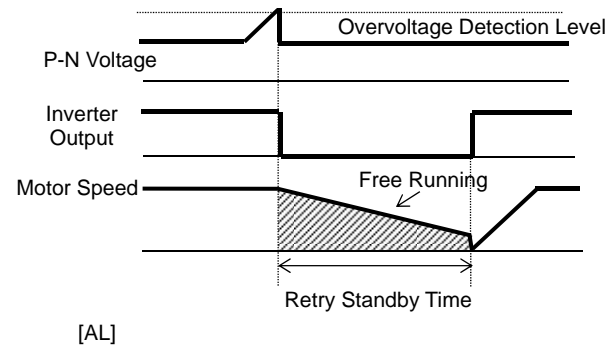
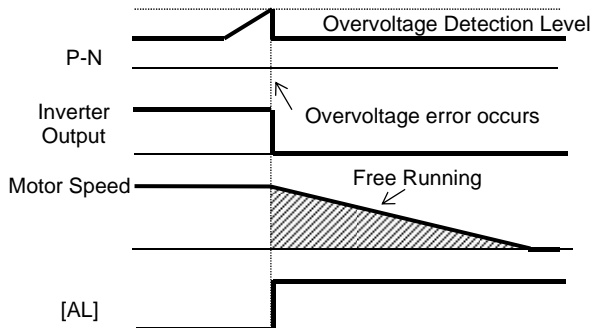

(Ex. 3) When [bb-23] ≠ 00 and [bb-30] = 01, it restarts by picking up the frequency.

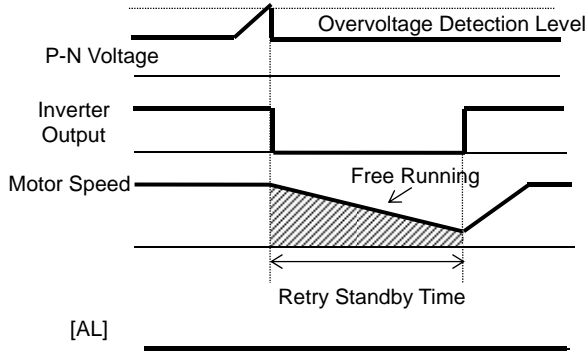

- See "12.14.3 Starting by picking up frequency" for details.

(Ex. 4) When [bb-23] ≠ 00 and [bb-30] = 02, it restarts with frequency pull-in.

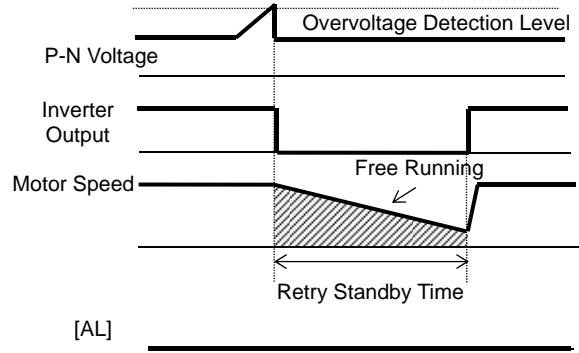

- See "12.14.4 Starting with frequency pull-in" for details.

(Ex. 5) When [bb-23] ≠ 00 and [bb-30] = 03, it restarts using the motor speed feedback.

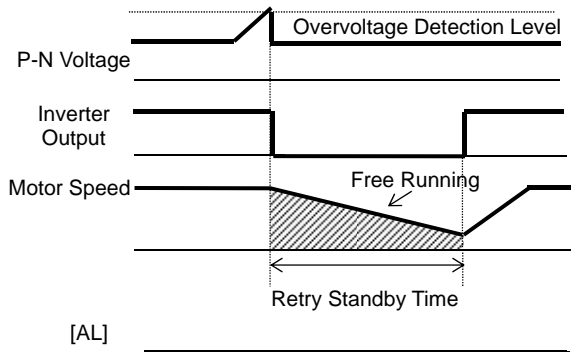

- For motor speed feedback, the feedback input to the input terminals A and B, or feedback input to the optional cassette P1-FB is required.

(Ex. 6) When [bb-23] ≠ 00 and [bb-30] = 04, it restarts by picking up the frequency, and then after deceleration according to the setting, the motor trips when stopped.

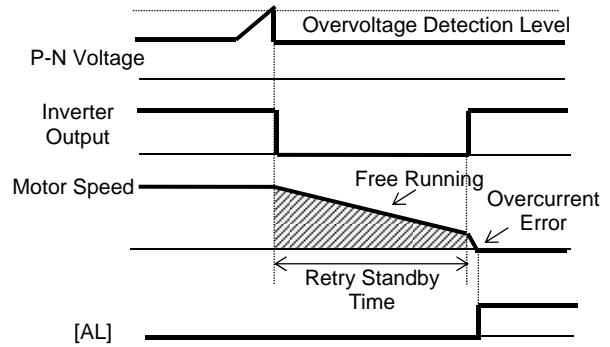

### 12.13.10 Continuing motor operation during instantaneous power failure for deceleration and stop

Q

- I want to decelerate and stop the motor even if the power supply has not recovered yet in case of instantaneous power failure.

A

- This function allows deceleration and stop of the motor while maintaining the voltage under the overvoltage level when the power supply is shut down during operation.
- One of the three modes can be selected with [bA-30] instantaneous power failure non-stop selection.



- Instantaneous power failure non-stop operation is activated when the input to the main power supply (R, S, T) drops.
- When [bA-30] is 01 or 02, the motor decelerates and stops after the function is activated. You need to turn off the operation command and turn it on again to restart after the stop. Even if the [bA-30] is 03, you still need to turn off the operation command and turn it on again if the motor decelerated and stopped without recovery after the function is activated.
- If the control power supply (R0, T0) is not input separately from main power supply, supply the P-N voltage to the control power supply (R0, T0) to use the instantaneous power failure non-stop function. When using this function, disconnect the J51 connector line connected to the R0 and T0 terminals and connect the wire from main terminal P to R0, and N to T0. Use electrical wire of 0.75mm<sup>2</sup> or larger.

#### Parameters

Item	Parameter	Data	Description
Instantaneous power failure non-stop selection	[bA-30]	00	Disabled
		01	Decelerates and stops, and maintains the stop status.
		02	Decelerates and stops with constant DC voltage control, and maintains the stop status.
		03	Decelerates and stops with constant DC voltage control, and maintains the stop status. If the power supply recovers during the process, the operation continues.
Instantaneous power failure non-stop function starting voltage	[bA-31]	(200 V class) 0.0~410.0(v) (400 V class) 0.0~820.0(v)	This is the voltage level at which the instantaneous power failure non-stop control starts when the internal power supply voltage drops.
Instantaneous power failure non-stop frequency constant voltage level	[bA-32]	(200 V class) 0.0~410.0(v) (400 V class) 0.0~820.0(v)	Switches the deceleration temporarily to constant speed operation when the internal power supply voltage increases due to deceleration.
Instantaneous power failure non-stop deceleration time	[bA-34]	0.01~3600.00(s)	Deceleration time setting for instantaneous power failure non-stop deceleration and stop operation.
Instantaneous power failure non-stop deceleration starting range	[bA-36]	0.00~10.00(Hz)	The setting for starting deceleration by lowering frequency during instantaneous power failure non-stop deceleration and stop operation.
Instantaneous power failure non-stop constant DC voltage control P control	[bA-37]	0.00~5.00	Proportional gain for PI control during constant DC voltage control.
Instantaneous power failure non-stop constant DC voltage control I control	[bA-38]	0.00~150.00(s)	Integral gain for PI control during constant DC voltage control.
Output terminal function	[CC-01]~[C C-07]	023	[IPS] Outputs the signal during instantaneous power failure non-stop deceleration. OFF: The function is not active. ON: Instantaneous power failure non-stop deceleration in function.

■ Instantaneous power failure non-stop  
Deceleration/Stop ([bA-30] = 01)

**A**

- This function allows deceleration and stop of the motor while maintaining the voltage under the instantaneous power failure non-stop frequency constant voltage level [bA-32] after the power supply was shut down during operation.
- If the power supply was shut down during operation, deceleration starts at the frequency lowered by deceleration starting width [bA-36] when the voltage drops to the instantaneous power failure non-stop function activating voltage [bA-31] or lower, and then decelerates for the instantaneous power failure non-stop deceleration time [bA-34].
- In case of regenerative status caused by deceleration torque during deceleration and if the internal power supply voltage reaches the frequency-constant voltage level [bA-32] or higher, the motor will be at constant speed until the internal power supply voltage falls below the overfrequency-constant voltage level [bA-32].



- If the frequency-constant voltage level [bA-32] < Function starting voltage [bA-31], it works by taking [bA-32] at the same level as [bA-31]. (However, the set values will not be changed)
- If the frequency-constant voltage level [bA-32] is lower than the input voltage multiplied by  $\sqrt{2}$ , the constant speed state will be maintained and deceleration will not take place if the power recovers while this function is in operation. (Power should be shut off and turned on again, or [bA-32] needs to be reset during operation.) The [bA-32] must be set to a value greater than the input voltage multiplied by  $\sqrt{2}$ .
- This function will not be disabled until the operation stop will be completed. To recover power and restart the operation while this function is in operation, input the stop command (operation command OFF) and then input the operation command again after the motor stopped.
- If the instantaneous power failure non-stop deceleration starting range [bA-34] is too large, sudden deceleration will cause overcurrent tripping.
  - If the value of [bA-36] is too low or the instantaneous power failure non-stop deceleration time [bA-34] is too long, insufficient regenerative force will cause undervoltage tripping.

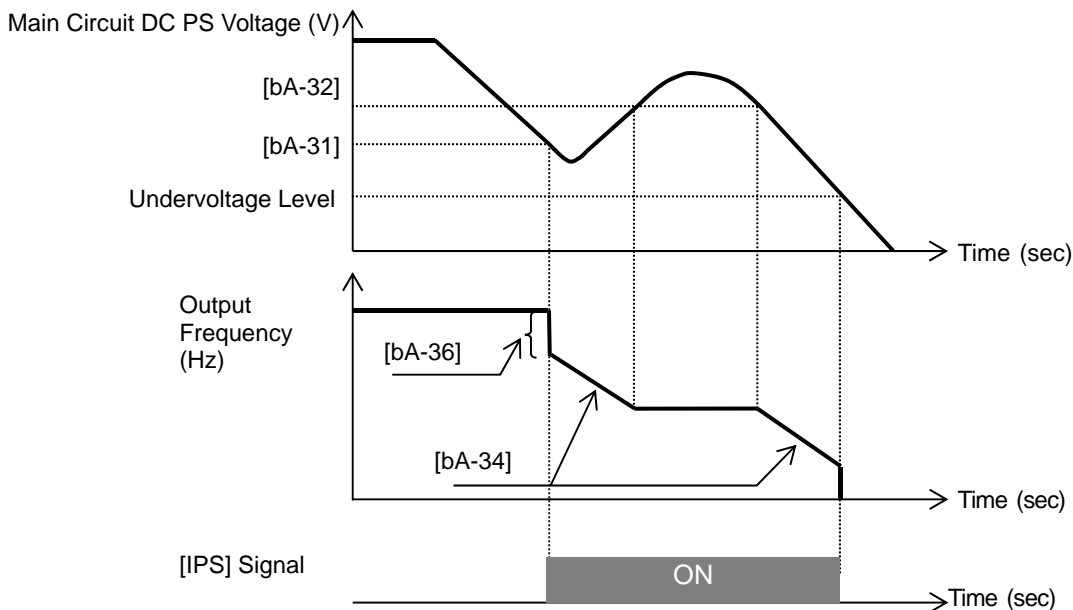

■ Instantaneous power failure non-stop constant DC voltage control  
 ([bA-30] = 02: No recovery, [bA-30] = 03: Recovery)

**A**

- This function maintains the main circuit DC voltage to the value set by [bA-32] instantaneous power failure non-stop level while decelerating if instantaneous power failure occurs or the main circuit DC voltage drops during operation.
- The condition to activate this function is when all the conditions below are met.
  - [bA-30] is 02 or 03
  - In operation (It will not function while being tripped, undervoltage or stopped)
  - When the instantaneous power failure occurs at the control power supply or when the main circuit DC voltage drops to b051, instantaneous power failure non-stop function starting voltage, or lower.

- If the instantaneous power failure time is short, continuous operation without interrupting output is possible. However, if undervoltage is observed upon instantaneous power failure, the output is interrupted immediately and this function will be terminated. The operation after recovering from the instantaneous power failure depends on the selection of how to restart after instantaneous power failure and undervoltage.
- When [bA-30] is 03, the normal operation can be restored if recovered from the instantaneous power failure and the power is received before the output will be interrupted. However, it may decelerate and stop depending on the [bA-31] setting. Details are given below.

[bA-30]	[bA-31]	Action
02 (No recovery)	[bA-32] > Main circuit DC voltage upon power recovery	Deceleration stop (constant DC voltage control) (Ex. 1)
	[bA-32] < Main circuit DC voltage upon power recovery	Deceleration stops (normal operation) (Ex. 2)
03 (With recovery)	[bA-32] > Main circuit DC voltage upon power recovery	Deceleration stop (constant DC voltage control) (Ex. 1)
	[bA-32] < Main circuit DC voltage upon power recovery	Operation (normal operation) (Ex. 2)

- This function is activated if the conditions to start operation mentioned above are met even if the power line for J51 connector connected to R0 and T0 terminals are disconnected to be connected from P of the main terminal to R0 and from N to T0, or even if the control power supply and main circuit power supply are powered independently.
- If the motor decelerates and stops as a result of this function activated, it will be forced to stop even if [FW] is ON. Verify that the power is restored before powering on [FW] again when restarting.

(Ex. 1)

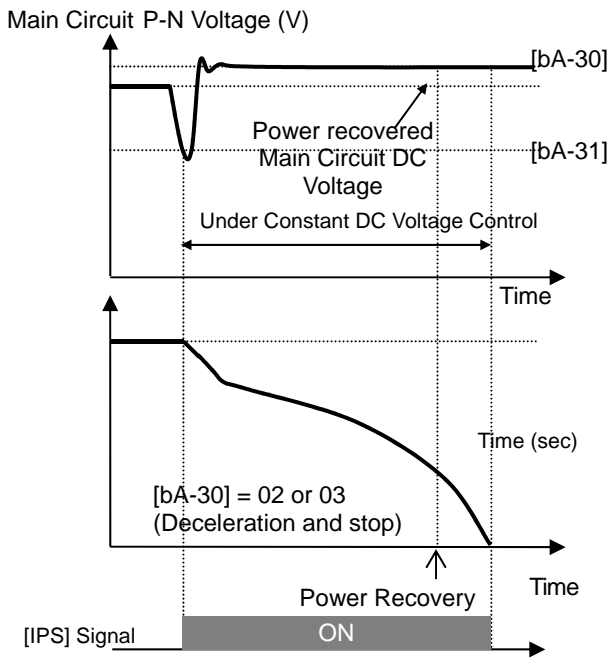

Note) Depending on the proportional gain and integral time settings, the main circuit DC voltage level while the function is being activated may be lower than [bA-32].



- Keep the settings for [bA-31] and [bA-32] to the undervoltage recovery level (P-N voltage 180 V (200 V class), 360 V (400 V class)) or higher. The function will not be activated in case of undervoltage.
- Make setting so that [bA-31] will be lower than [bA-32]. If the difference between the settings for [bA-31] and [bA-32] is great, setting the proportional gain [bA-37] to be too large may cause sudden acceleration immediately after this function is activated and may cause overcurrent.

(Ex. 2)

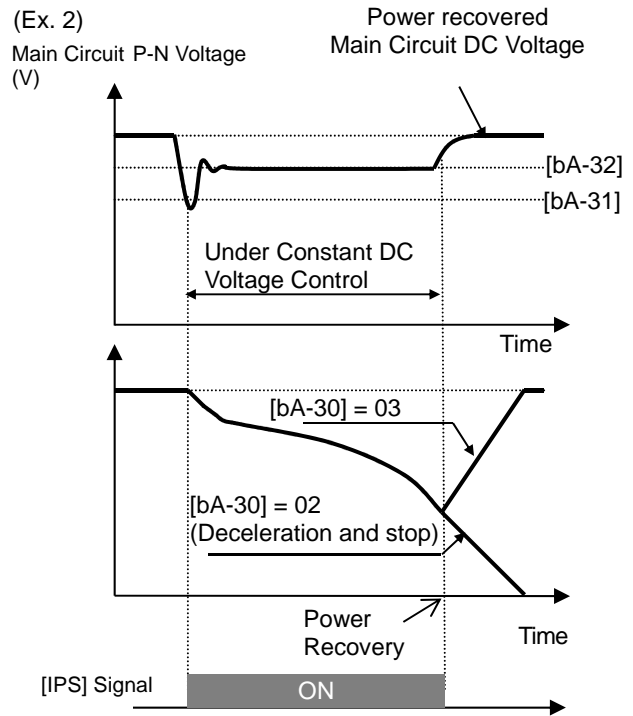

- When [bA-30] is 02 or 03, PI control is performed so that the internal DC voltage will be constant.
- Setting the proportional gain [bA-37] to be large will accelerate the response. However, setting it to be too large will dissipate the control, tending to cause tripping.
- Setting the integral gain [bA-38] to be short will accelerate the response. However, setting it to be too short will also tend to cause tripping.
- If the proportional gain [bA-37] is small, the motor will trip due to undervoltage because the voltage will drop immediately after the function is activated.
- If you would like to retry even if the power failure may be relatively long, supply the P-N voltage to R0 and T0.

## 12.14 Changing the Start Mode

### 12.14.1 Starting with increasing voltage gradually



- How to minimize overcurrent at starting when the minimum frequency has been set high to obtain a higher torque.



- This function allows you to make the inverter increase the voltage gradually when starting the motor while outputting the minimum frequency.
- The time to reach the output voltage for the reduced voltage start can be set with [Hb131].



- Set a small value for the reduced voltage start selection [Hb131] if you intend to increase the start torque. On the other hand, setting a small value will cause the inverter to perform full-voltage starting and to easily trip because of overcurrent.
- This function is effective only when V/f control (constant torque characteristics, reduced torque characteristics, or free V/f control) is selected for the control method [AA121].

Item	Parameter	Data	Description
Minimum frequency	[Hb130]	0.00~10.00(Hz)	This is the start frequency.
Reduced voltage start time	[Hb131]	0~2000(ms)	Increases the output voltage over the set time, from the operation start to the voltage command equivalent to the minimum frequency.

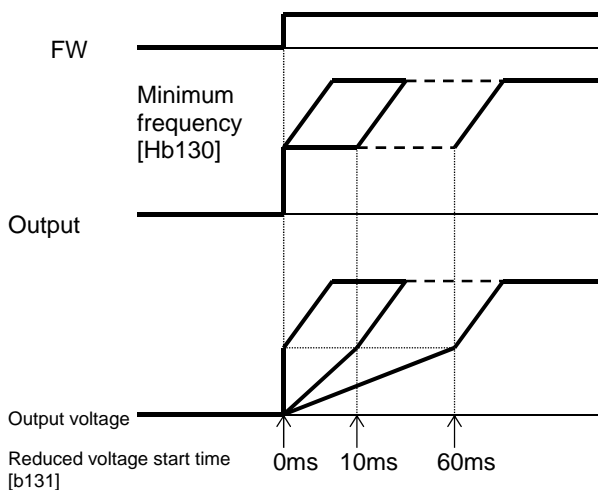



12.14.2 Starting with DC braking

**Q**

- How to start after having rotation fan stopped
- How to start operation after having rotating motor stopped

**A**

- Before outputting the frequency to the motor, apply DC braking to stop the motor rotating. And then, start operation.
- To use DC braking for starting, the following settings are required:
  - Set [AF101] DC braking selection to 01
  - Set [AF102] Braking mode selection to 00
  - Set [AF109] DC braking time for starting to other than 0.0
- In DC braking for starting, DC braking is performed, after the operation command is given, for the period of time set for the DC braking time for starting [AF109].

**!**

- Depending on the set braking force, the carrier frequency may automatically go down to protect the inverter.
- When setting or operating [AF108] DC braking force for starting and [AF109] DC braking time for starting, pay attention to heat generation on the motor.

■ Example of a case where the DC braking function for starting is applied

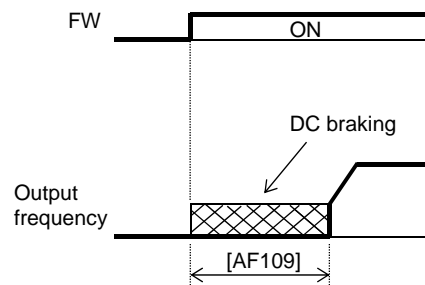

■ Parameter

Item	Parameter	Data	Description
DC braking selection	[AF101]	00	Internal DC braking: Disabled
		01	Internal DC braking: Enabled
		02	Internal DC braking: Enabled (operable only at the set frequency)
Braking mode selection	[AF102]	00	Enables the DC braking.
DC braking force for starting	[AF108]	0~100(%)	Adjusts the DC braking force. The maximum braking force is achieved when set to 100%.
DC braking time for starting	[AF109]	0.0~60.0(s)	Valid when the internal DC braking is enabled. Starts the DC braking when the operation command is turned on.

**!**

- If [AF101] DC braking selection is set to 02, DC braking will be started when both the frequency command and the output frequency become equal to or lower than [AF103] DC braking frequency setting, regardless of whether the motor is running or stopped. See "12.15.2 Stopping with DC braking" for details.
- If [AF102] Braking mode selection is set to other than 00, see "12.14.9 Starting after applying servo-lock".

12.14.3 Starting by picking up frequency



- How to start operation with the frequency matched with the motor idling speed
- How to start operation matched with frequency at the time of trip retry, free-run stop, reset, power-on, etc.



- To achieve these goals when the motor is idling due to a trip or terminal function, enable the frequency matching function so that the inverter is started by picking up frequency applied to each function.
- Obtain the cycle of the motor residual voltage to start operation.
- Frequency matching lower limit setting [bb-42] is the parameter common to frequency matching functions.



- Even if frequency matching restart is selected, the inverter may restart with 0 Hz if:
  1. the output frequency is equal to or lower than 1/2 of the base frequency,
  2. the voltage induced on the induction motor quickly attenuates, or
  3. the frequency matching lower limit setting [bb-42] is set and the inverter detects a frequency equal to or lower than that.
- If the restart after free-run stop or the restart after reset is performed, the inverter will restart after the retry wait time after instantaneous power failure/under-voltage has elapsed.
- The restart after free-run stop and the restart after reset will be performed if the operation command is continuously input via a terminal command or other ways.
- If the frequency matching restart does not go well because the residual voltage rapidly decreases or for other reasons, it may go well by using the frequency pull-in restart. See "12.14.4 Starting with frequency pull-in".

(Ex. 1) The motor speed is equal to or more than the frequency matching lower limit setting.

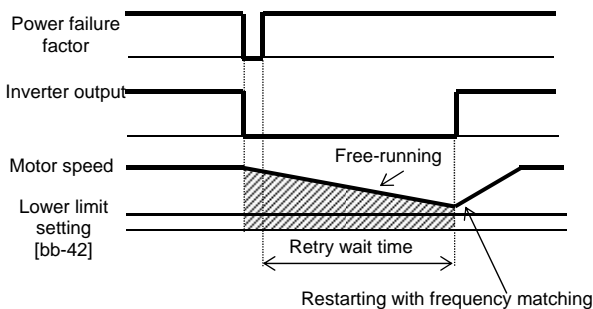

(Ex. 2) The motor speed is equal to or lower than the frequency matching lower limit setting

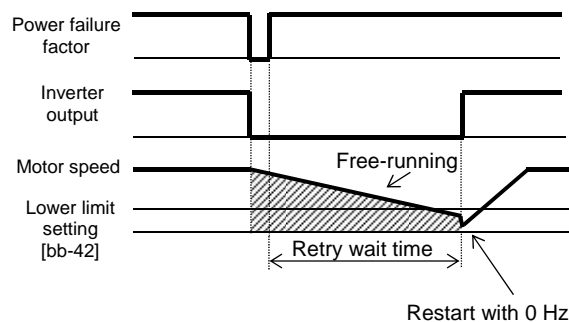

Parameter

Item	Parameter	Data	Description
Frequency matching lower limit setting	[bb-42]	0.00~590.00(Hz)	When the detected value is equal to or lower than the set value, the inverter restarts with 0 Hz.



- For the retry function, see "12.13 Using Trip Avoidance Function" as well.

- When instantaneous power failure/under-voltage occurs [bb-24]=01

Ex. 1: Power recovery within Allowable instantaneous power failure time [bb-25]

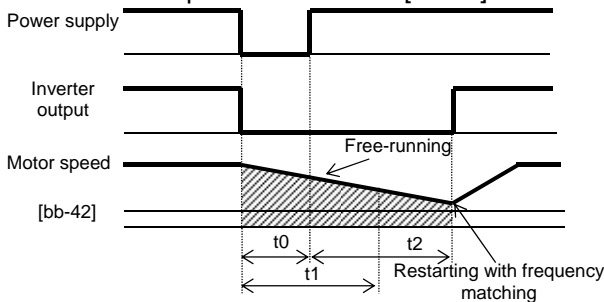

- t0: Instantaneous power failure time
- t1: Allowable instantaneous power failure time [bb-25]
- t2: Retry wait time [bb-26]
- Ex. 2: Power recovery after Allowable instantaneous power failure time [bb-25]

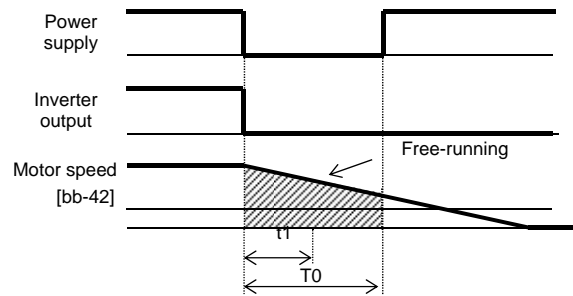

Item	Parameter	Data	Description
Selection of instantaneous power failure/under-voltage retry	[bb-24]	01	Performs frequency matching restart.
Allowable instantaneous power failure time	[bb-25]	0.3~25.0(s)	Restarts the motor if it is within the allowable time.
Retry wait time after instantaneous power failure/under-voltage	[bb-26]	0.3~100.0(s)	Sets the wait time after the operation command.



- If a power failure has occurred so that the power to the inverter's control power supply terminals (R0, T0) is lost, and then the inverter is restarted, it is considered as power-on and the inverter will operate in accordance with the restart after reset [bb-41].
- Even if the power to control power supply terminals (R0, T0) is lost, it will take time until the internal power supply is completely lost.
- Trip after instantaneous power failure/under-voltage can be switched between "enabled" and "disabled" by using [bb-27] Selection of instantaneous power failure/under-voltage trip during stopping. This will prevent the occurrence of an error during stopping. If the error is prevented, the output terminal [AL] will not turn on.
- In a system where the power to control power supply terminals (R0, T0) gradually decreases, it is possible to cause a trip when Allowable instantaneous power failure time has elapsed.
- To make the power to control power supply terminals (R0, T0) last as much as possible by the inverter alone during an instantaneous power failure, remove the J51 connector cables from terminals R0 and T0, and connect a cable from P on the main circuit terminal block to R0, and N on the main circuit terminal block to T0. Use 0.75 mm<sup>2</sup> or heavier wires for the connections.

■ Retry on overcurrent [bb-28]=01  
(Ex.) Retry operation on overcurrent

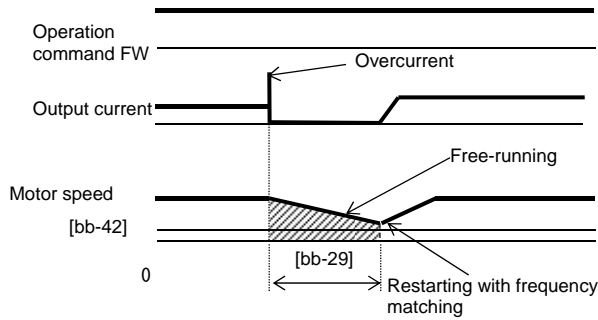

Item	Parameter	Data	Description
Overcurrent trip/retry selection	[bb-28]	01	Performs frequency matching restart.
Retry wait time after overcurrent	[bb-29]	0.3~100.0(s)	Sets the wait time after the operation command.

■ Retry on overvoltage [bb-30]=01  
(Ex.) Retry operation on overvoltage

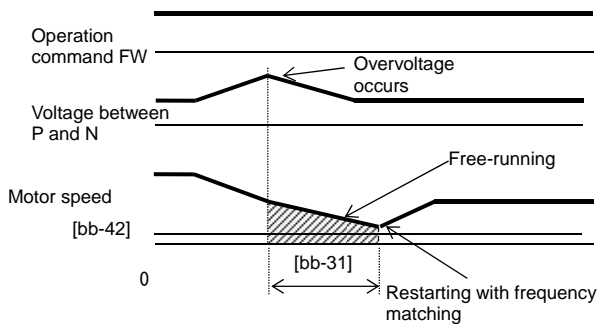

Item	Parameter	Data	Description
Overvoltage trip/retry selection	[bb-30]	01	Performs frequency matching restart.
Retry wait time on overvoltage	[bb-31]	0.3~100.0(s)	Sets the wait time after the operation command.

■ Frequency matching after free-run stop [FRS] [bb-40]=01  
(Ex.) Frequency matching operation after free-run stop [FRS]

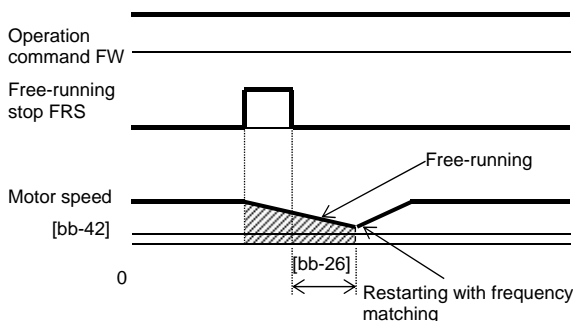

Item	Parameter	Data	Description
Restart after free-run stop	[bb-40]	01	Performs frequency matching restart.
Retry wait time after instantaneous power failure/under-voltage	[bb-26]	0.3~100.0(s)	Sets the wait time after the operation command.

■ Frequency matching after reset [RS] [bb-41]=01  
(Ex.) Frequency matching operation after reset [RS]

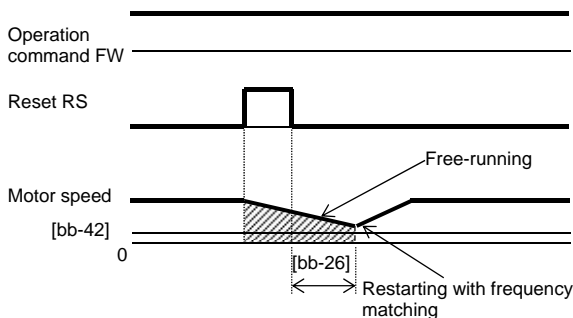

Item	Parameter	Data	Description
Restart after reset	[bb-41]	01	Performs frequency matching restart.
Retry wait time after instantaneous power failure/under-voltage	[bb-26]	0.3~100.0(s)	Sets the wait time after the operation command.

\*) If the frequency matching after reset has been set, starting after power-on will also occur with matched frequency.

12.14.4 Starting with frequency pull-in

Q

- How to start operation by quickly following the frequency command regardless of the frequency at which the motor is idling
- How to quickly follow the frequency command at the time of a trip retry, free-run stop, reset, power-on, etc.

A

- To achieve these goals when the motor is idling due to a trip or terminal function, enable the frequency pull-in function so that the inverter is started with the output frequency specified to each function.
- Even if a motor residual voltage is lost, the inverter will restart at the frequency selected in [bb-47] Start frequency selection for frequency pull-in restart.

(Ex.) How the frequency pull-in works

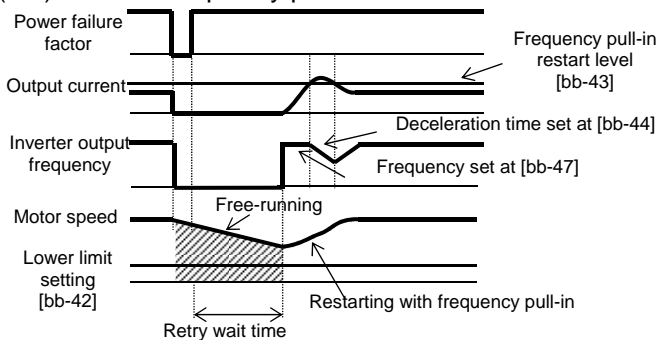

!

- If the restart after free-run stop or the restart after reset is performed, the inverter will restart after the retry wait time after instantaneous power failure/under-voltage has elapsed.
- The restart after free-run stop and the restart after reset will be performed when the operation command is given.
- The frequency pull-in restart function can be used only for induced motor drive. In addition, if [AA121] Control mode is set to other than the V/f control, restart may become unstable. In this case, see "12.14.3 Starting by picking up frequency".
- When frequency pull-in with the V/f control is selected, the inverter starts with a suppressed output voltage during the time set for [bb-45] Frequency pull-in operation time (voltage). When sensorless vector control, zero-speed range sensorless vector control, or vector control with sensor is selected, the frequency is automatically pulled in while controlling the current.
- If the current increases during frequency pull-in to exceed [bb-43] Restart level, the motor will decelerate over the time set for [bb-44] Frequency pull-in operation time (frequency).
- If the current rapidly increases during frequency pull-in to exceed [bb-46] Overcurrent suppression level for frequency pull-in restart, the overcurrent suppression function will automatically set in.

Parameter

Item	Parameter	Data	Description
Frequency matching lower limit setting	[bb-42]	0.00~590.00(Hz)	When the detected value is equal to or lower than the set value, the inverter restarts with 0 Hz.
Frequency pull-in restart level	[bb-43]	Inverterrated current × (0.20 to 2.00)	Determines whether or not the current has increased at restart.
Frequency pull-in operation time (frequency)	[bb-44]	0.10~30.00(s)	Sets the deceleration time for an increase in the current.
Frequency pull-in operation time (voltage)	[bb-45]	0.10~30.00(s)	Sets the time to start with reduced output voltage.
Overcurrent suppression level for frequency pull-in restart	[bb-46]	Inverterrated current × (0.00 to 2.00)	Sets the level of the current at which a sudden current increase at restarting is prevented.
Start frequency selection for frequency pull-in restart	[bb-47]	00	Starts at the frequency at the previous shutoff.
		01	Starts at the maximum frequency.
		02	Starts at the current frequency command.

- When instantaneous power failure/under-voltage occurs [bb-24]=02

Ex. 1: Power recovery within Allowable instantaneous power failure time [bb-25]

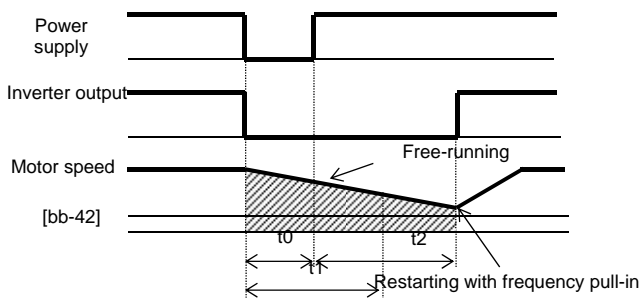

- t0: Instantaneous power failure time
- t1: Allowable instantaneous power failure time [bb-25]
- t2: Retry wait time [bb-26]
- Ex. 2: Power recovery after Allowable instantaneous power failure time [bb-25]

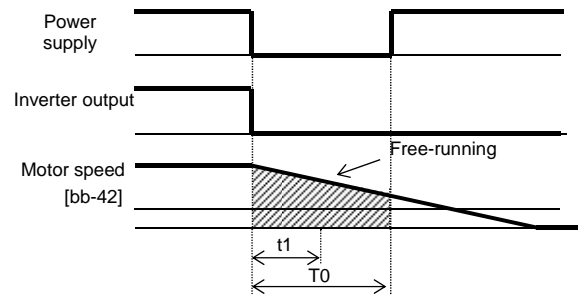

Parameter

Item	Parameter	Data	Description
Selection of instantaneous power failure/under-voltage retry	[bb-24]	02	Performs frequency pull-in restart.
Allowable instantaneous power failure time	[bb-25]	0.3~25.0(s)	Restarts the motor if it is within the allowable time.
Retry wait time after instantaneous power failure/under-voltage	[bb-26]	0.3~100.0(s)	Sets the wait time after the operation command.



- If a power failure has occurred so that the power to the inverter's control power supply terminals (R0,T0) is lost, and then the inverter is restarted, it is considered as power-on and the inverter will operate in accordance with the restart after reset [bb-41].
- Even if the power to control power supply terminals (R0, T0) is lost, it will take time until the internal power supply is completely lost.
- Trip after instantaneous power failure/under-voltage can be switched between "enabled" and "disabled" by using [bb-27] Selection of instantaneous power failure/under-voltage trip during stopping. This will prevent the occurrence of an error during stopping. If the error is prevented, the output terminal [AL] will not turn on.

- In a system where the power to control power supply terminals (R0, T0) gradually decreases, it is possible to cause a trip when Allowable instantaneous power failure time has elapsed.
- To make the power to control power supply terminals (R0, T0) last as much as possible by the inverter alone when an instantaneous power failure occurs, remove the J51 connector cables from terminals R0 and T0, connect the main circuit terminals P and R0 to each other, and connect the main terminals N and T0 to each other. Use 0.75 mm<sup>2</sup> or heavier wires for the connections.

■ Retry on overcurrent [bb-28]=01  
(Ex.) Retry operation on overcurrent

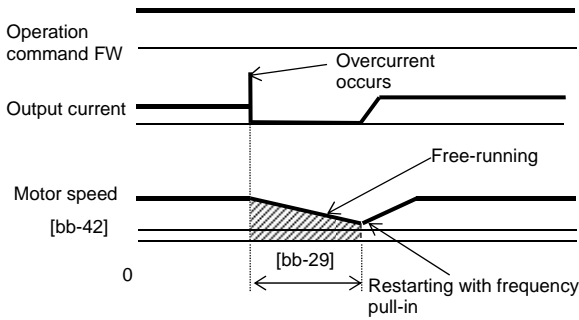

Item	Parameter	Data	Description
Overcurrent trip/retry selection	[bb-28]	02	Performs frequency pull-in restart.
Retry wait time after overcurrent	[bb-29]	0.3~100.0(s)	Sets the wait time after the operation command.

■ Retry on overvoltage [bb-30]=01  
(Ex.) Retry operation on overvoltage

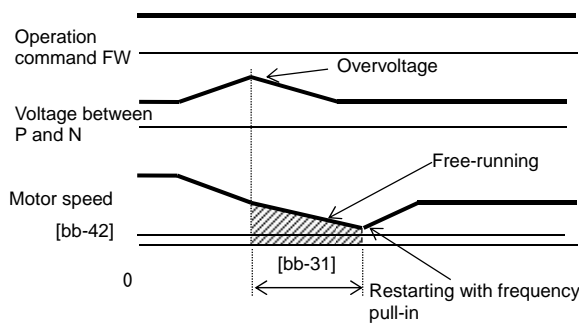

Item	Parameter	Data	Description
Overvoltage trip/retry selection	[bb-30]	02	Performs frequency pull-in restart.
Retry wait time on overvoltage	[bb-31]	0.3~100.0(s)	Sets the wait time after the operation command.

■ Frequency matching after free-run stop [FRS] [bb-40]=01  
(Ex.) Frequency matching operation after free-run stop [FRS]

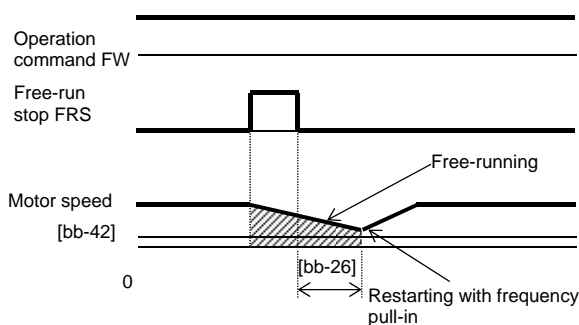

Item	Parameter	Data	Description
Restart after free-run stop	[bb-40]	02	Performs frequency pull-in restart.
Retry wait time after instantaneous power failure/under-voltage	[bb-26]	0.3~100.0(s)	Sets the wait time after the operation command.

■ Frequency matching after reset [RS] [bb-41]=01  
(Ex.) Frequency matching operation after reset [RS]

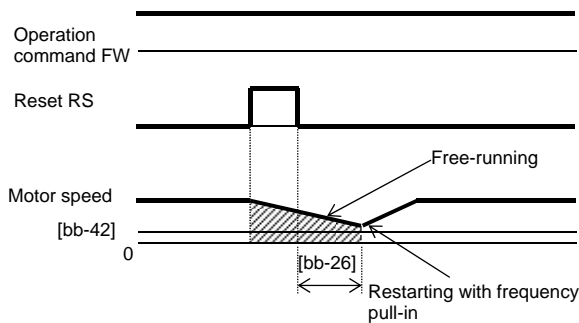

Item	Parameter	Data	Description
Restart after reset	[bb-41]	02	Performs frequency pull-in restart.
Retry wait time after instantaneous power failure/under-voltage	[bb-26]	0.3~100.0(s)	Sets the wait time after the operation command.

\*) If the frequency matching after reset has been set, starting after power-on will also occur matched with frequency.

12.14.5 Starting after power-on

**Q**

- How to start operation matched with frequency because the motor is idling at power-on
- How to start operation with 0 Hz because the brake is applied at starting

**A**

- Sets the start mode at power-on.

(Ex. 1) Restart operation with 0 Hz: [bb-41]=00

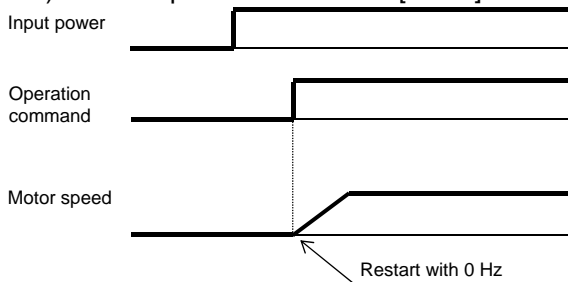

**!**

- The operation at power-on is the same as that of the restart after reset stop which occurs when the inverter recovers from reset.
- If the frequency pull-in restart is used, the rotational direction of the output frequency is the same as that of the frequency command.
- If a power failure lasts long and the inverter's internal power supply is lost, recovery will take place by the restart after reset instead of the restart after instantaneous power failure/under-voltage.
- In the case of [bb-41]=01, if the residual voltage generated by the motor cannot be detected, the 0 Hz restart may take place.

(Ex. 2) Frequency pull-in operation [bb-41]=01 to 03

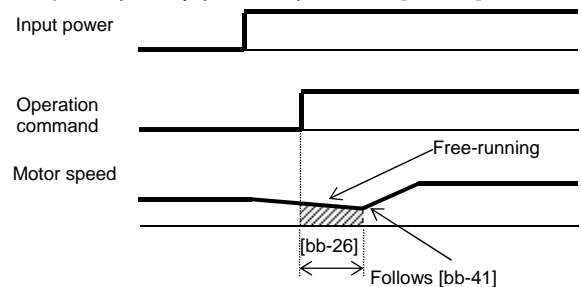

■ Parameter

Item	Parameter	Data	Description
Restart after reset	[bb-41]	00	Performs the 0 Hz restart.
		01	Performs frequency matching restart.* 1)
		02	Performs frequency pull-in restart.* 2)
Retry wait time after instantaneous power failure/under-voltage	[bb-26]	0.3~100.0(s)	Sets the wait time after the operation command.

\* 1) See "12.14.3 Starting by picking up frequency".

\*2) See "12.14.4 Starting with frequency pull-in".



12.14.6 Starting after reset

**Q**

- How to start operation matched with frequency because the motor is idling at trip reset
- How to start operation with 0 Hz because the brake is applied after a trip

**A**

- Set the start mode after a trip reset or a reset input via the [RS] terminal (input terminal function 028).

(Ex. 1) Restart operation with 0 Hz: [bb-41]=00

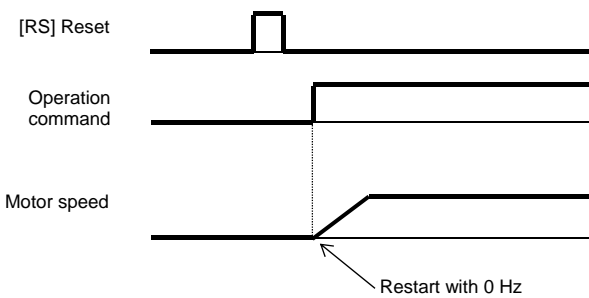

(Ex. 3) Restart with 0 Hz: [bb-41]=00

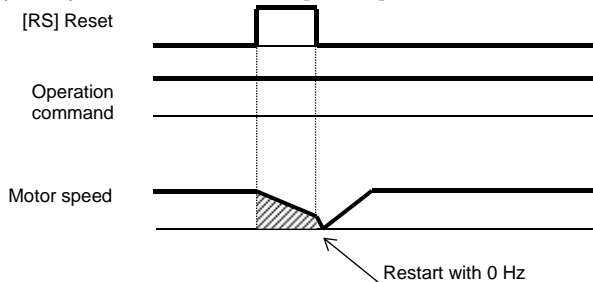

**!**

- The restart after reset, which occurs when the inverter recovers from a reset, is the same as the mode at power-on.
- If the frequency pull-in restart is used, the rotational direction of the output frequency is the same as the command direction at shut-off.
- If a power failure lasts long and the inverter's internal power supply is lost, recovery will take place by the restart after reset instead of the restart after instantaneous power failure/under-voltage.
- In case of the 0 Hz restart, there is no wait time.

(Ex. 2) Frequency pull-in [bb-41]=01 to 03

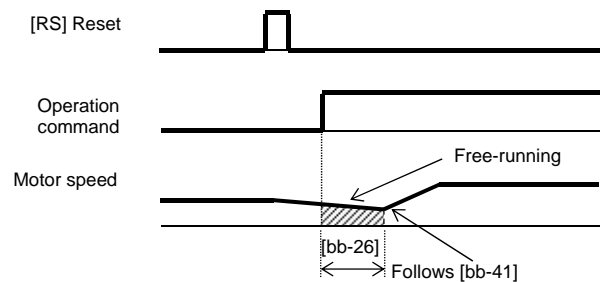

(Ex. 4) Frequency pull-in [bb-41]=01 to 03

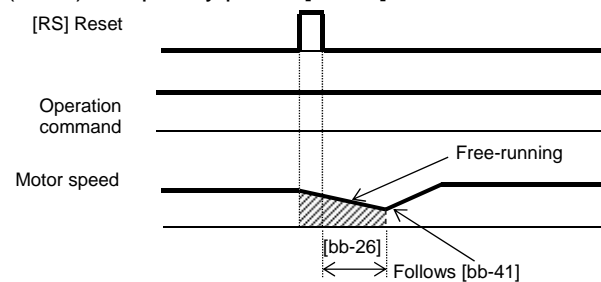

■ Parameter

Item	Parameter	Data	Description
Restart after reset	[bb-41]	00	Performs the 0 Hz restart.
		01	Performs frequency matching restart.* 1)
		02	Performs frequency pull-in restart.* 2)
Retry wait time after instantaneous power failure/under-voltage	[bb-26]	0.3~100.0(s)	Sets the wait time after the operation command.

\* 1) See "12.14.3 Starting by picking up frequency".

\*2) See "12.14.4 Starting with frequency pull-in".

12.14.7 Starting after free-run stop

Q

- How to start operation matched with frequency because the motor is idling when the free-run stop terminal is turned off.
- How to start operation with 0 Hz because the brake is applied at stopping although free-run stop has been specified for stopping

A

- Set the start mode after free-run stop command is input via the [FRS] terminal (input terminal function 032), (Ex.1) to (Ex. 4), or start mode after stop when FRS (free run to stop) is specified for [AA115] Stop mode selection, (Ex. 5) and (Ex. 6).
- (Ex. 1) to (Ex. 4) below are examples where a free-run stop command is input using the [FRS] terminal.

!

- The restart after reset, which occurs when the inverter recovers from a reset, is the same as the mode at power-on.
- If the frequency pull-in restart is used, the rotational direction of the output frequency is the same as that of the frequency command.
- If a power failure lasts long and the inverter's internal power supply is lost, recovery will take place by the restart after reset instead of the restart after instantaneous power failure/under-voltage.
- At power-on, the inverter will start operation with 0 Hz.
- In case of the 0 Hz restart, there is no wait time.

(Ex. 1) Restart with 0 Hz: [bb-40]=00

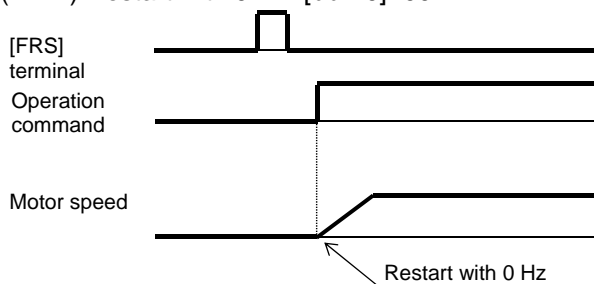

(Ex. 2) Frequency pull-in [bb-40]=01 to 03

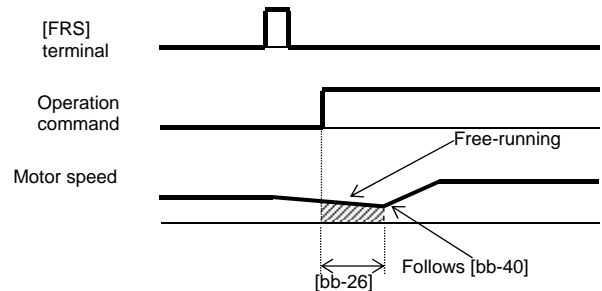

(Ex. 3) Restart with 0 Hz: [bb-40]=00

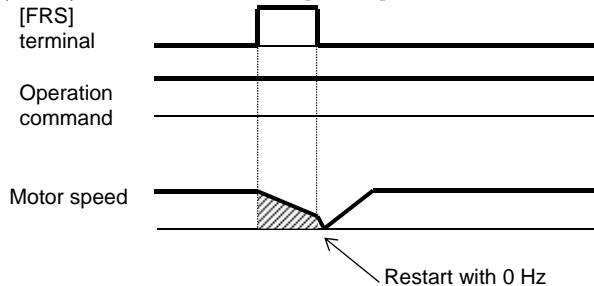

(Ex. 4) Frequency pull-in [bb-40]=01 to 02

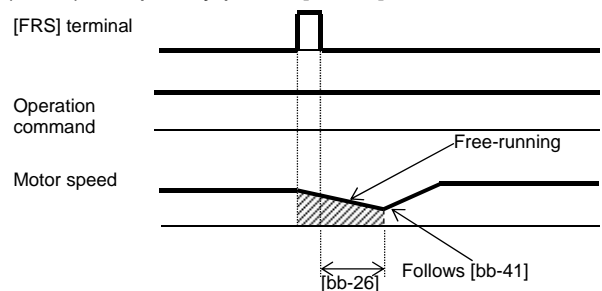

**A**

- (Ex. 5) and (Ex. 6) below show cases where the free-run stop is performed via the operation command.

- The free-run stop at stopping is used when an overvoltage error occurs at stopping, for example. However, the motor continues rotating through inertia.

(Ex. 5) Restarting with 0 Hz: [bb-40]=00

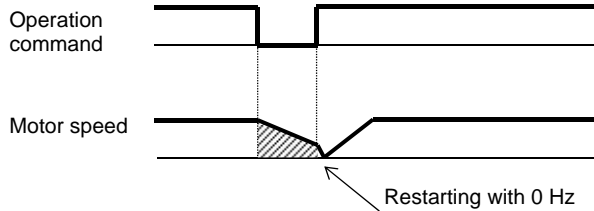

(Ex. 6) Frequency pull-in [bb-40]=01 to 02

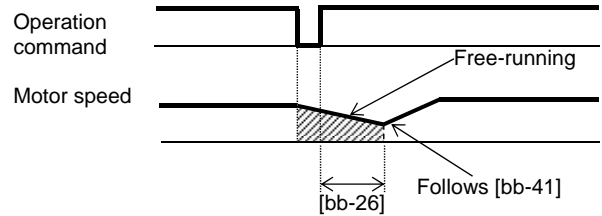

■ Parameter

Item	Parameter	Data	Description
Restart after free-run stop	[bb-40]	00	Performs the 0 Hz restart.
		01	Performs frequency matching restart.* 1)
		02	Performs frequency pull-in restart.* 2)
Retry wait time after instantaneous power failure/under-voltage	[bb-26]	0.3~100.0(s)	Sets the wait time after the operation command.
Stop method selection	[AA115]	01	Performs the free-run stop when the operation command is off.

\* 1) See "12.14.3 Starting by picking up frequency".

\*2) See "12.14.4 Starting with frequency pull-in".

12.14.8 Making torque rise faster

**Q**

- How to make torque rise faster
- The motor starts rotating slowly after an operation command is given.

**A**

- This function is to preliminarily establish magnetic flux by applying an excitation current via the forcing terminal [FOC] command.
- This function operates if the input terminal function 066 [FOC] is assigned.

- When [AA115] Stop mode selection is set to 00

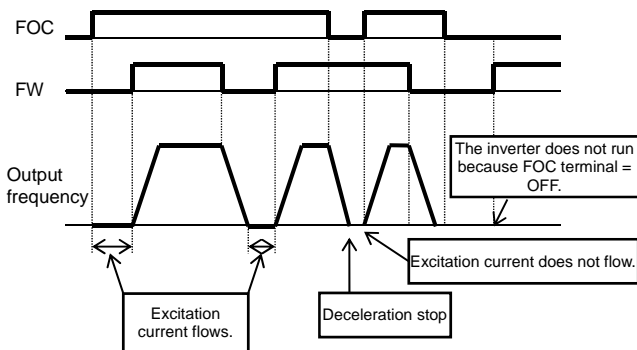

**!**

- This function is effective when the IM sensorless vector control, IM zero-speed range sensorless vector control, or IM vector control with sensor is selected for the control mode [AA121].
- If [FOC] is assigned to the input terminal function, operation will not be accepted unless [FOC] is turned on.
- If [FOC] is turned off during operation, the inverter will be operated according to [AA115] Stop mode selection. If a free run occurs, restart will take place according to the setting for the restart after free-run stop.

- When [AA115] Stop mode selection is set to 01

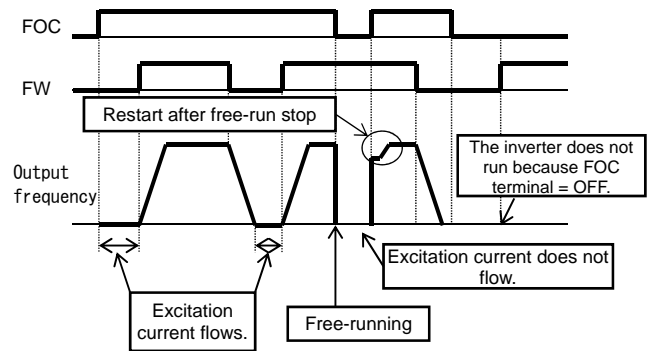

■Parameter

Item	Parameter	Data	Description
Input terminal function	[CA-01]~[CA-11]	066	Forcing function [FOC]
Stop mode selection	[AA115]	00	Performs the deceleration stop when the operation command is off.
		01	Performs the free-run when the operation command is off.
Restart after free-run stop	[bb-40]	00	Performs the 0 Hz restart.
		01	Performs frequency matching restart.* 1)
		02	Performs frequency pull-in restart.* 2)
Retry wait time after instantaneous power failure/under-voltage	[bb-26]	0.3~100.0(s)	Sets the wait time after the operation command.

\* 1) See "12.14.3 Starting by picking up frequency".

\*2) See "12.14.4 Starting with frequency pull-in".

**!**

- If torque at starting is insufficient, it may improve by adjusting the boost amount at starting [HC111], [HC112] or the speed response [HA115]. See "12.9 Selecting the Motor Control Mode according to Motor and Load".

- If torque at starting is insufficient, it may improve by using the torque bias function. See "12.11.6 Operating with torque command added".

**12.14.9** Starting after applying servo-lock

**Q**

- How to start operation after having the rotating motor stopped and secured it

**A**

- Before outputting the frequency to the motor, perform the servo-lock to stop the motor rotating. And then, start operation.
  - To apply DC braking for starting (servo-lock control), the following settings are required:
    - [AA121] Control mode (see the right section)
    - Set [AF101] DC braking selection to 01
    - Set [AF102] Braking mode selection to 01 or 02.
    - Set [AF109] DC braking time for starting to other than 0.0
  - If the DC braking for starting (servo-lock control) is enabled, DC braking (servo-lock control) will be performed after the operation command is given, for the period of time set as DC braking time for starting [AF109].
- Example of a case where the servo-lock control at starting is enabled

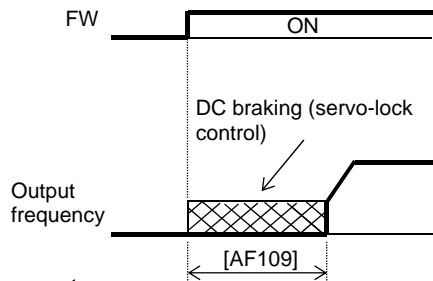

■ Parameter

Item	Parameter	Data	Description
DC braking selection	[AF101]	00	Internal DC braking: Disabled
		01	Internal DC braking: Enabled
		02	Internal DC braking: Enabled (The braking operates only with the set braking frequency.)
Braking mode selection	[AF102]	01	Enables the speed servo-lock.
		02	Enables the position servo-lock.
DC braking time for starting	[AF109]	0.0~60.0(s)	Valid when the internal DC braking is enabled. Starts the servo-lock when the operation command is turned on.
Control mode	[AA121]	08	Sensorless vector control
		09	Zero-speed range sensorless vector control
		10	Vector control with sensor



- Depending on the set braking force, the carrier frequency may automatically go down to protect the inverter.
- To use the servo-lock control, it is necessary to set [AA121] Control mode. If the applicable control mode is not selected, the inverter will operate as if [AF102] has been set to 00: DC braking.

(1) When [AF102] Braking mode selection is set to 01: Speed servo-lock

No.	[AA121] Control mode
1	09: Zero-speed range sensorless vector control
2	10: Vector control with sensor

(2) When [AF102] Braking mode selection is set to 02: Position servo-lock

No.	[AA121] Control mode
1	10: Vector control with sensor

- For [AA121] Control mode and [AA123] Vector control mode selection, it is necessary to set . See "12. 9 Selecting the Motor Control Method According to Motor and Load".
- The output of the servo-lock control is automatically calculated according to the selected control mode.

## 12.15 Changing the Stop Mode

### 12.15.1 Selecting the stop mode

#### Q

- How to shut down the output without decelerating the motor because a moment of inertia is so large that it causes overvoltage
- How to shut down the inverter output immediately because the mechanical brake is used to stop the motor

#### !

- If [AA115]=01 free-run stop is selected, the output will be shut off when the operation command is turned off.

#### A

- Use [AA115] Stop mode selection to select one of the two methods of stopping the motor when the operation command is turned off. One is to stop the motor according to the deceleration time; the other is to immediately cut off the output to shut down.
- If a free-run stop is to be input from a terminal, assign 032 [FRS] to an input terminal, and turn on the terminal.
- If the free-run stop is selected, the restart when an operation command is given the next time will follow the selection at [bb-40] Restart after free-run stop.

#### Parameter

Item	Parameter	Data	Description
Stop mode selection	[AA115]	00	Normal stop (deceleration → stop)
		01	Free-run stop
Restart after free-run stop	[bb-40]	00	Restart with 0 Hz
		01	Frequency matching restart
		02	Frequency pull-in restart
Input terminal selection	[CA-01]~[CA-11]	032	Uses the Free-run stop function [FRS].

#### When free-run stop is selected: [AA115]=01

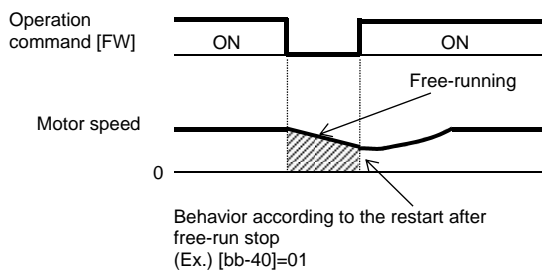

#### When the [FRS] terminal is used

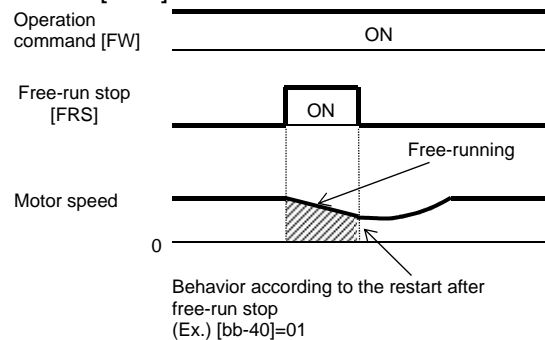

## 12.15.2 Stopping with DC braking

Q

- How to stop the motor when a large moment of inertia makes it continue rotating even after deceleration stop

A

- To use DC braking for stopping, the following settings are required:
  - Set [AF101] DC braking selection to 01
  - Set [AF102] Braking mode selection to 00
  - [AF105] DC braking force
  - Set [AF106] DC braking time to other than 0.0
- To use DC braking with frequency command, the following settings are required:
  - Set [AF101] DC braking selection to 02
  - Set [AF102] Braking mode to 01 or 02.
  - Set [AF103] DC braking frequency setting to other than 0.00
  - [AF105] DC braking force
  - Set [AF106] DC braking time to other than 0.0



- The carrier frequency during DC braking depends on [bb101], but it is limited to at maximum 5 kHz. Depending on the set braking force, the carrier frequency may automatically go down to 2 kHz.
- When the motor is stopped by using [DB] external DC braking function (input terminal function 030), a high output frequency or a high-inertia load may cause an overcurrent error or overvoltage error.

## ■ Parameter

Item	Parameter	Data	Description
DC braking selection	[AF101]	00	Internal DC braking: Disabled
		01	Internal DC braking: Enabled
		02	Internal DC braking: Enabled (The braking operates only with the frequency command.)
Braking mode selection	[AF102]	00	Enables the DC braking.
DC braking frequency setting	[AF103]	0.00~590.00(Hz)	With internal DC braking enabled, DC braking is started when the output frequency reaches or becomes less than the frequency set for stopping.
DC braking delay time	[AF104]	0.00~5.00(s)	Specifies the delay in starting DC braking while temporarily shutting off the output.
DC braking force	[AF105]	0~100(%)	Adjusts the DC braking force. When "0%" is specified, no braking operation will be performed.
DC braking time	[AF106]	0.00~60.00(s)	Sets the duration for DC braking. This setting is valid for the [DB] terminal in edge mode or for the internal DC braking. When "0.00 s" is specified, no braking operation will be performed.
DC braking/edge or level selection	[AF107]	00	Edge mode (Examples 1-a to 6-a)
		01	Level mode (Examples 1-b to 6-b)
Input terminal function	[CA-01]~[CA-11]	030	DC braking is enabled by using the [DB] terminal. OFF: DC braking is disabled. ON: DC braking is enabled.

■ DC braking force for stopping



- To use the DC braking force for stopping, set [AF101] DC braking selection to 01, [AF102] Braking mode selection to 00, [AF106] DC braking time to other than 0.00 s, and [AF105] DC braking force to any any value. When the frequency output is shut off, DC braking force will be applied.
- The braking force is adjusted at the [AF105] DC braking force.
- When [AF104] DC braking delay time is set, and if the operation command is turned off and the decelerated frequency falls below [AF103] DC braking frequency, the output will be shut off once, and after [AF104] has elapsed, DC braking will be started.
- Edge mode: [AF107]=00  
[AF106] DC braking time setting is given priority, and the inverter performs DC braking for the time set for [AF106]. After the operation command is turned off, if the output frequency falls below [AF103] DC braking frequency, DC braking will be applied for the time set for [AF106]. Even if the operation command is turned on during DC braking, DC braking continues until the time set for [AF106] elapses. (Ex. 1), (Ex. 2)



- The operation to be performed when the operation command is switched from the stop command to the start command varies depending on the setting of [AF107] DC braking/edge or level selection.
- When setting [AF105] DC braking force and [AF106] DC braking time, pay attention to the heat generation on the motor.
- Level mode: [AF107]=01  
Operation commands are given priority. The inverter ignores [AF106] DC braking time and transits to the normal operation. If the start command is turned on during DC braking, the inverter ignores the time set for [AF106] and returns to the normal operation. (Ex. 3), (Ex. 4)

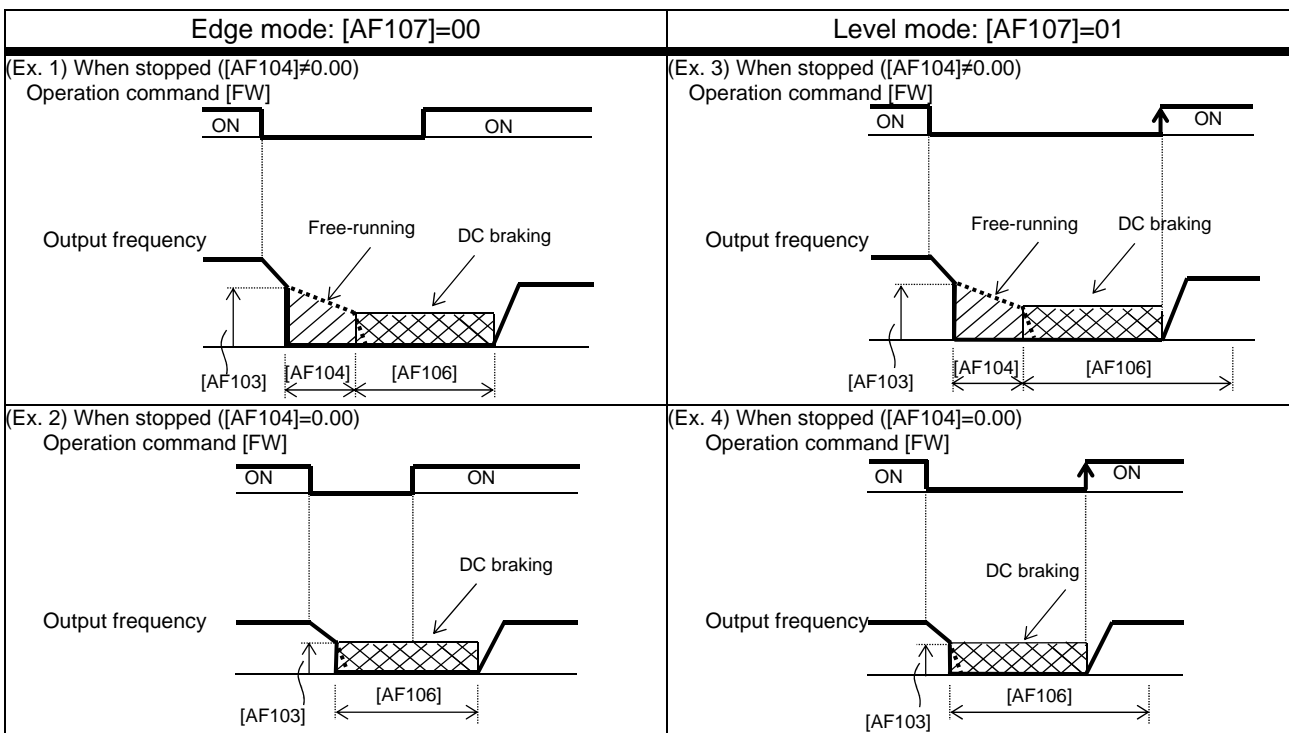



■ DC braking with frequency command



- To use the DC braking with frequency command, set [AF101] DC braking selection to 02, and [AF106] DC braking time to other than 0.0 s. DC output can be started by changing the frequency command.
- The inverter starts DC braking when both the frequency set by the frequency command and the output frequency fall to [AF103] or below. (Ex. 5)
- This function operates only when the operation command is on.

- If the operation command is turned on after the frequency command has been established (where a value larger than [AF103]+2 Hz is input), the inverter will start operation with the normal output.
- If the frequency command at starting is "0" when the operation command is given via an analog input terminal, the inverter will start operation with DC braking because both the frequency set by the frequency command and current output frequency are "0". (Ex. 6)

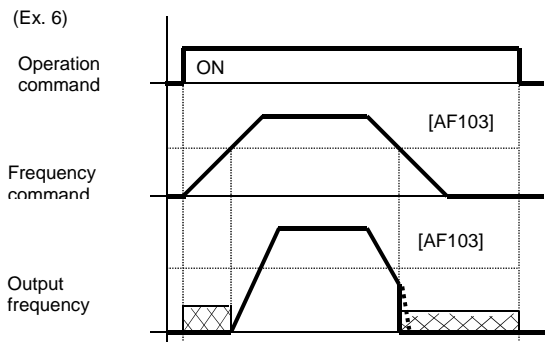
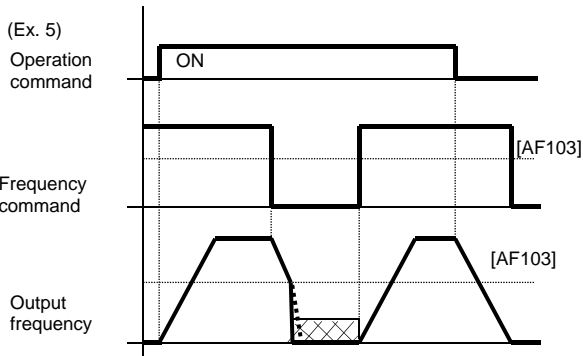

- How the inverter returns to the normal operation varies depending on the setting of the DC braking/edge or level selection [AF107].
- When "00" is specified for [AF107], the inverter returns to the normal operation after [AF106] DC braking time has elapsed. (Ex. 7)

- When [AF107]=01: The inverter starts acceleration when the frequency command exceeds [AF103]+2 Hz. (Ex. 8)

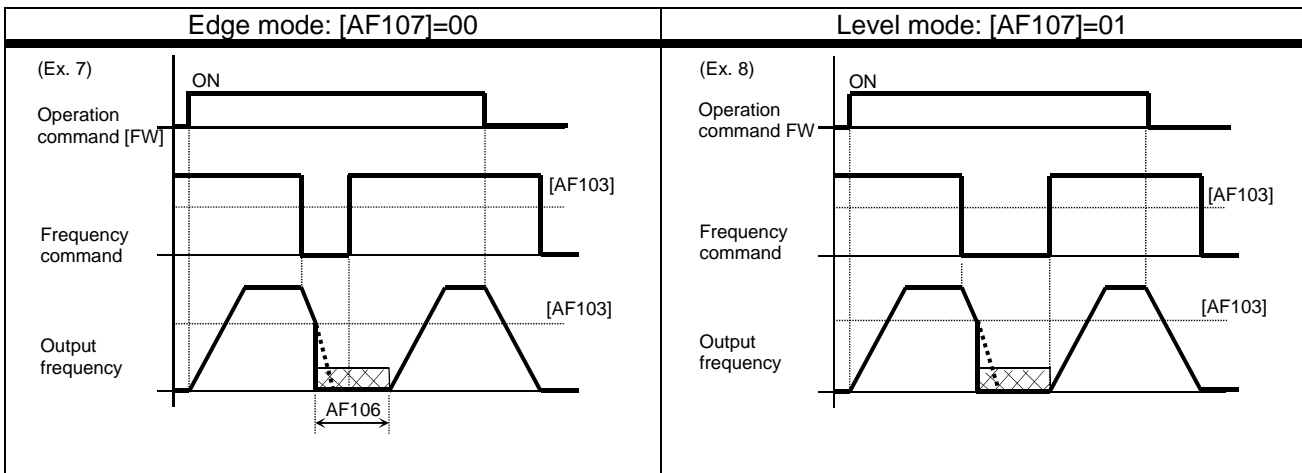

- If the function of the DC braking with frequency command is enabled, [DB] (input terminal 030) will be disabled.
- If the function of the DC braking with frequency command is enabled, the setting of [AF102] will be disabled and DC braking with [AF102]=00 will operate.

External DC braking via terminal function

**A**

- Assign 030 [DB] to input terminal functions [CA-01] to [CA-11].
- When [AF101]=00 or 01, DC braking will be applied depending on whether the [DB] terminal is on or off.
- Adjust the braking force by adjusting the [AF105] DC braking force.
- When you set the [AF104] DC braking delay time, the inverter output will be shut off within the set period of delay, and the motor will run freely during the period. (Ex. 11), (Ex. 14)
- DC braking will be restarted after the set period has elapsed.
- Select the braking mode by the DC braking/edge or level selection [AF107], and then make any other necessary settings suitable for your system.
- When [AF107]=00: After [DB] is turned on, the inverter performs DC braking for the time set for [AF106]. (Example 9) to (Example 11)
- When [AF107]=01: The inverter performs DC braking only when [DB] is on. (Ex. 12) to (Ex. 14)



- When setting [AF105] DC braking force, [AF106] DC braking time, or the ON time of the [DB] terminal (input terminal function 030), pay attention to the heat generation on the motor.
- The setting for the [DB] terminal is given priority over operation commands. (Ex. 9), (Ex. 12)
- If the [DB] terminal is turned on when the motor speed is high, an overcurrent error or an overvoltage error may occur.
- When the [DB] terminal is turned on, DC braking mode that occurs when "00" is specified for [AF102] Braking mode selection is performed regardless of the setting for [AF102].

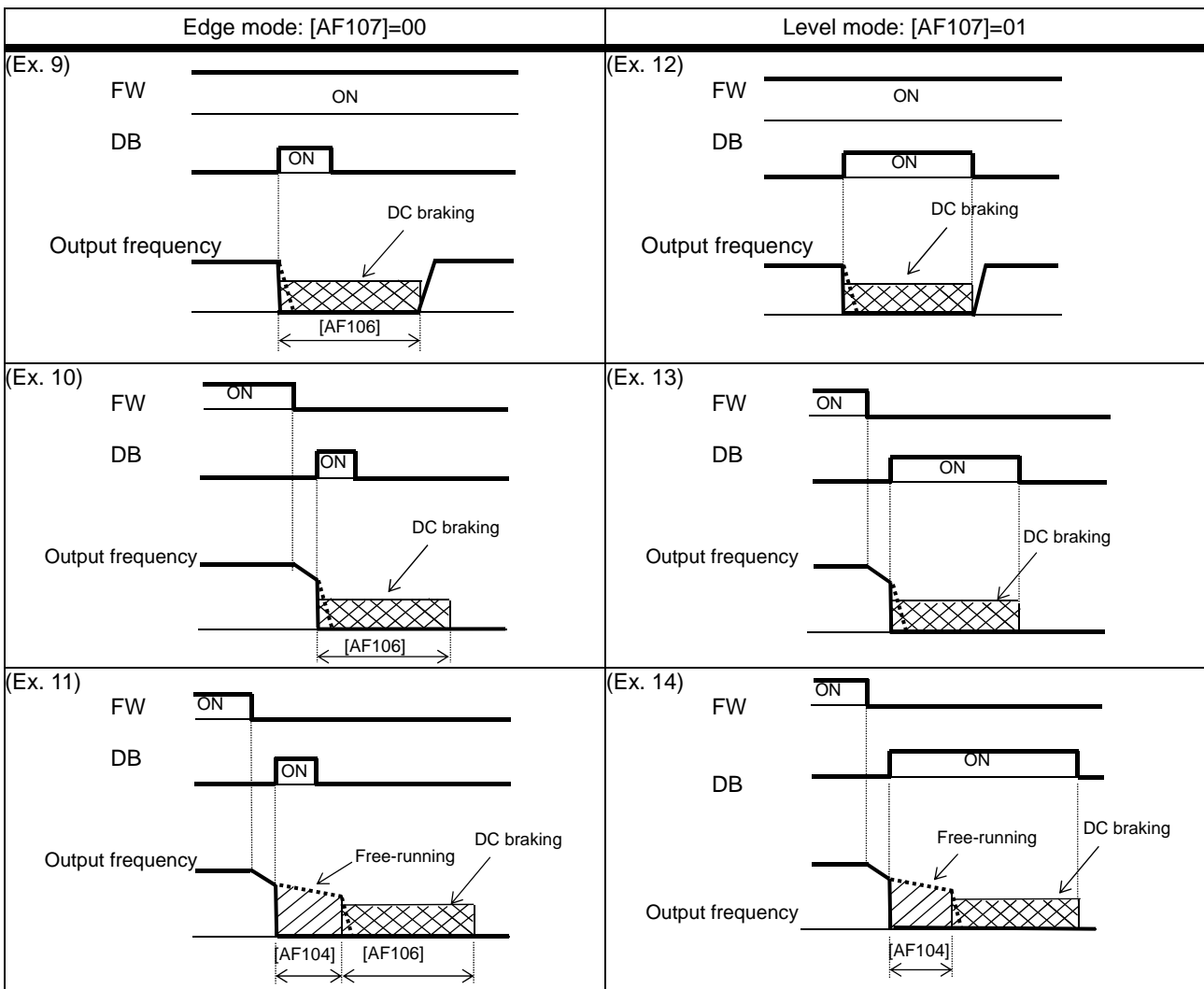

12.15.3 Stopping with servo-lock



- How to stop the motor when a large moment of inertia makes it continue rotating even after deceleration stop
- How to stop the motor at a fixed position



- To use DC braking for stopping (servo-lock control), the following settings are required:
  - [AA121] Control mode (see the right section)
  - Set [AF101] DC braking selection to 01
  - Set [AF102] Braking mode selection to 01 or 02.
  - Set [AF106] DC braking time to other than 0.0



- The carrier frequency during DC braking depends on [bb101], but it is limited to at maximum 5 Hz. Depending on the set braking force, the carrier frequency may automatically go down to 2 kHz.
- To use the servo-lock control, it is necessary to set [AA121] Control mode. If the applicable control mode is not selected, the inverter will operate as if [AF102] has been set to 00: DC braking.

(1) When [AF102] Braking mode selection is set to 01: Speed servo-lock

No.	[AA121] Control mode
1	09: 0Hz-range sensorless vector control
2	10: Vector control with sensor

(2) When [AF102] Braking mode selection is set to 02: Position servo-lock

No.	[AA121] Control mode
1	10: Vector control with sensor

- To use the servo-lock control, it is necessary to set [AA121] Control mode. See "12. 9 Selecting the Motor Control Method According to Motor and Load".
- The output of the servo-lock control is automatically calculated according to the selected control mode.

Parameter

Item	Parameter	Data	Description
DC braking selection	[AF101]	00	Internal DC braking: Disabled
		01	Internal DC braking: Enabled
		02	Internal DC braking: Enabled (The braking operates only with the set braking frequency.)
Braking mode selection	[AF102]	01	Enables the speed servo-lock.
		02	Enables the position servo-lock.
DC braking frequency	[AF103]	0.00~590.00(Hz)	With internal DC braking enabled, DC braking is started when the output frequency reaches or becomes less than the frequency set for stopping.
DC braking delay time	[AF104]	0.00~5.00(s)	Specifies the delay in starting DC braking while temporarily shutting off the output.
DC braking time	[AF106]	0.00~60.00(s)	Sets the duration for DC braking. This setting is valid for the [DB] terminal in edge mode or for the internal DC braking. When "0.00 s" is specified, no braking operation will be performed.
DC braking edge or level selection	[AF107]	00	Edge mode (Examples 1-a to 6-a)
		01	Level mode (Examples 1-b to 6-b)
Input terminal function	[CA-01]~[CA-11]	054	Controls with the servo-on mode using the [SON] terminal. OFF: Servo lock is disabled. ON: Servo lock is enabled.
Control mode	[AA121]	08	Sensorless vector control
		09	Zero-speed range sensorless vector control
		10	Vector control with sensor

### ■ DC braking for stopping (servo-lock control)

**A**

- To use DC braking for stopping (servo-lock control), set [AA121] Control mode and [AF101] DC braking selection to 01, [AF102] Braking mode selection to 01 or 02, and [AF106] DC braking time to other than 0.00 s. DC braking will operate after the frequency output has been shut off.
- When [AF104] DC braking delay time is set, and if the operation command is turned off, and if the decelerated frequency falls below [AF103] DC braking frequency, the output will be shut off once, and after [AF104] has elapsed, DC braking will be started.
- Edge mode: [AF107]=00  
[AF106] DC braking time setting is given priority, and the inverter performs DC braking (servo-lock control) for the time set for [AF106]. After the operation command is turned off, if the output frequency falls below [AF103] DC braking frequency, DC braking will be applied for the time set for [AF106]. Even if the operation command is turned on during DC braking, DC braking continues until the time set for [AF106] elapses. (Ex. 1), (Ex. 2)



- The operation to be performed when the operation command is switched from the stop command to the start command varies depending on the setting of [AF107] DC braking/edge or level selection.
- When setting [AF106] DC braking time, pay attention to the heat generation on the motor.
- To use the servo-lock control, it is necessary to set [AA121] Control mode. See "12.9 Selecting the Motor Control Method According to Motor and Load".
- The output of the servo-lock control is automatically calculated according to the selected control mode.
- Level mode: [AF107]=01  
Operation commands are given priority. The inverter ignores [AF106] DC braking time and transits to the normal operation. If the start command is turned on during DC braking, the inverter ignores the time set for [AF106] and returns to the normal operation. (Ex. 3), (Ex. 4)

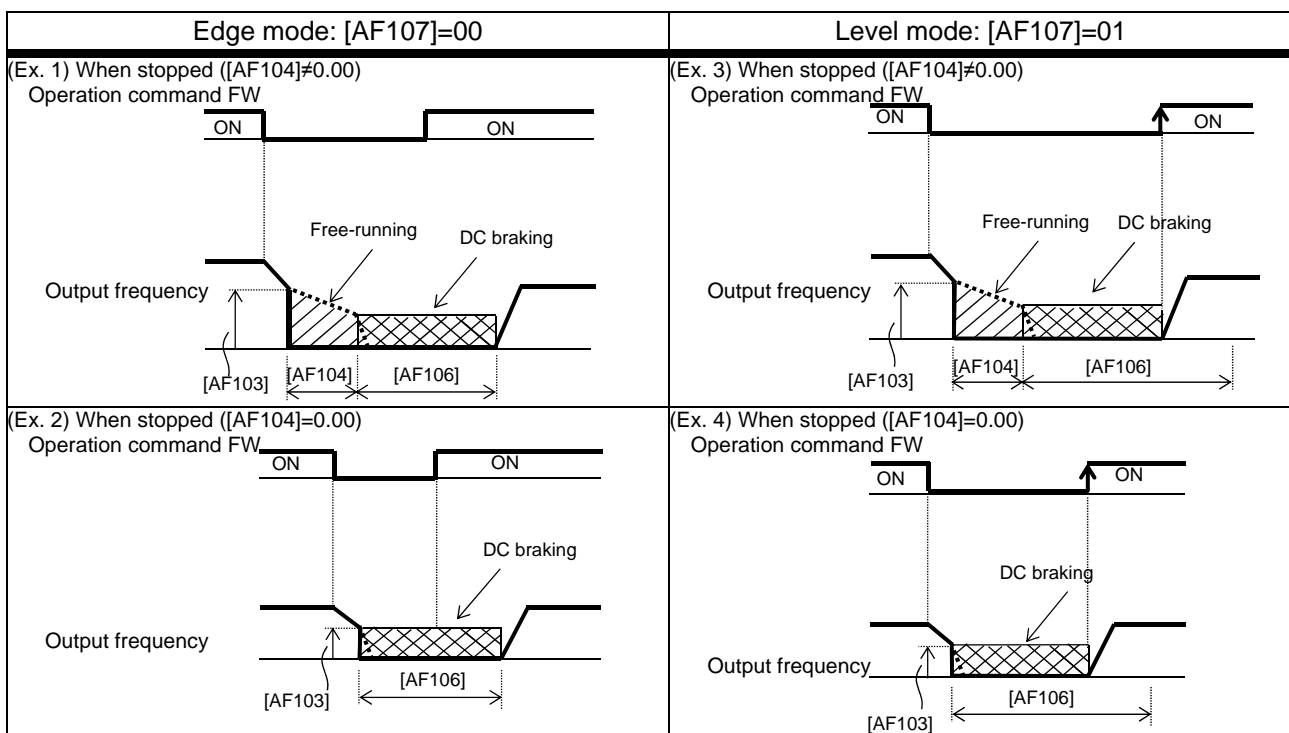



## 12.16 Using Protection Functions

### 12.16.1 Detecting input phase loss

**Q**

- How to prevent system failure due to unstable motor operation when a phase loss occurs by breakage of the input power cable

**A**

- Enable the input phase loss protection function by using [bb-65] Input phase loss protection selection.
- When the input phase loss protection function has been enabled, an input phase loss error [E024] will occur if a phase loss state due to disconnection or breakage of the input power cable continues for 1 second or more.

**!**

- When 3-phase AC is not input to power supply terminals R, S, and T, such as in cases where DC voltage is input to R and T or between P and N of the inverter, this function is disabled regardless of the setting for [bb-65].
- There will be no detection during an instantaneous power failure.
- If an input phase loss error [E024] occurs, it is necessary to cut off the power supply to the inverter and check the state of wiring and breakers.

#### ■ Parameter

Item	Parameter	Data	Description
Input phase loss protection selection	[bb-65]	00	Disabled
		01	Enabled

### 12.16.2 Detecting output phase loss



- How to prevent system failure due to unstable motor operation because a phase loss occurs by breakage of the output cable to the motor



- Enable the output phase loss protection function by using [bb-66] Output phase loss protection selection.
- When the output phase loss protection function has been enabled, an output phase loss error [E034] will occur if a phase loss caused by disconnection or breakage of the motor cable continues.



- If the capacity of the drive motor is smaller than that of the inverter, the inverter may detect an output phase loss erroneously. In this case, decrease the value of [bb-67] or set [bb-66] to 00.
- If the carrier frequency [bb101] is low, the inverter may detect an output phase loss erroneously. It may improve by increasing the value of the carrier frequency [bb101].
- This function operates when the output speed is between 5 Hz and 100 Hz.
- Set the value of [bb-67] equal to or lower than the steadily flowing current, with the rated current being 100%.

#### ■Parameter

Item	Parameter	Data	Description
Output phase loss protection selection	[bb-66]	00	Disabled
		01	Enabled
Output phase loss detection sensitivity	[bb-67]	1 ~ 100(%)	Adjusts the sensitivity of the output phase loss
Carrier frequency	[bb101]	0.5~16.0(kHz) *1)	Changes the carrier frequency

\*1) The following restriction is applied:

For LD rated capacity, 12.0 kHz at maximum

For VLD rated capacity, 10.0 kHz at maximum

**12.16.3** Making the inverter trip from an external unit



- How to shut off the inverter's output when the system produces an error



- This function is enabled by setting 033 [EXT] as an input terminal function. When a signal connected to the applicable terminal changes, an error [E012] occurs.
- Use this function when you want to trip the inverter via an error (trip) signal generated by a peripheral system.



- When the inverter trips with error code [E12] displayed, the trip is not reset even if the error signal from the external equipment is reset (EXT terminal is turned off). To reset the trip, perform the reset operation or turn the power off and on again.
- If you reset the inverter while the terminal [EXT] is turned on, [E012] will occur again.
- After the reset, the inverter follows [bb-41] Restart after reset. See "12.14.6 Starting after reset".
- When the terminal [EXT] is turned on, an error will occur even if the inverter output is turned off, and the inverter trips with [E012] displayed.

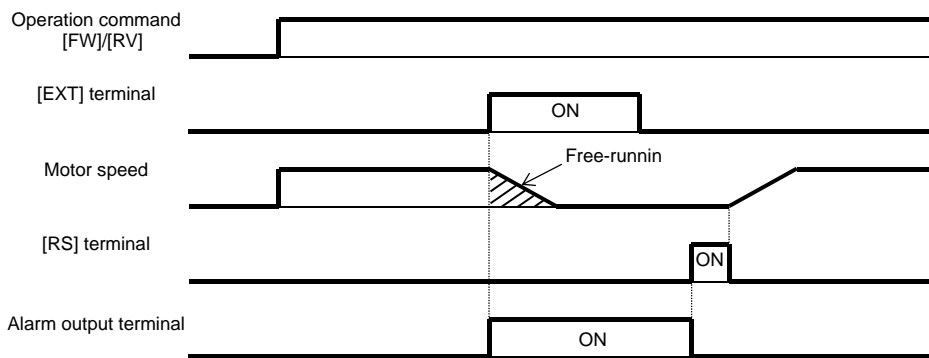

Item	Parameter	Data	Description
Input terminal function	[CA-01]~[CA-11]	033	[EXT]: When the terminal corresponding to the assigned position is turned on, an external trip occurs.



**12.16.4** Preventing restart immediately after power recovery

**Q**

- How to prevent the motor from starting rotation suddenly when the inverter power is turned on
- How to stop the motor with an error signal when the power is turned on again while an operation command is present

**!**

- Unlike other types of trip, the USP error [E013] automatically clears when the operation command is turned off.
- The power recovery restart prevention function operates for 2 seconds at maximum after the control power is input.

**A**

- This function allows you to make the inverter trip with error code [E13] displayed if the inverter power is turned on when an operation command has been turned on.
- You can recover the inverter from tripping by performing the reset operation or turning the operation command off. (Ex. 1)
- If the inverter is recovered from tripping with the operation command left turned on, the inverter will start operation immediately after recovery. (Ex. 2)
- The inverter can operate normally when an operation command is turned on after the inverter power is turned on. (Ex. 3)

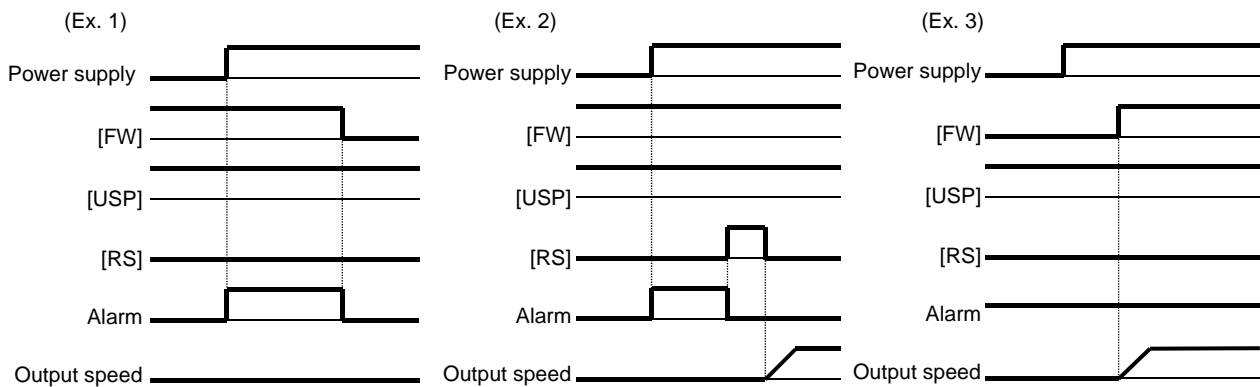

■ Parameter

Item	Parameter	Data	Description
Input terminal function	[CA-01]~[CA-11]	034	[USP]: If the applicable [USP] terminal assigned to an input terminal has been turned on, the inverter will trip when the power is recovered while an operation command is present.

### 12.16.5 Adjusting overcurrent error level



- How to prevent overcurrent from flowing in the motor
- How to lower the overcurrent protection threshold to prevent the magnet from demagnetizing when a magnetic motor is driven



- By the setting of the overcurrent detection level [bb160], you can adjust the threshold current value used for detecting the overcurrent error [E001].



- If the threshold level for overcurrent is lowered, the overcurrent error [E001] is more likely to occur. Therefore, it is necessary to lower the levels for the overload restriction function and the overcurrent suppression function. For details, see "12.13 Using Trip Avoidance Function".

#### ■ Parameter

Item	Parameter	Data	Description
Overcurrent detection level	[bb160]	Inverter ND rated current × (0.20 to 2.20)	Sets the threshold level used for detecting overcurrent.

**12.16.6** Making the inverter trip after an instantaneous power failure/under-voltage



- How to make the inverter trip when the power supply voltage of the inverter has dropped
- How to stop the inverter with an error signal when an instantaneous power failure has occurred



■ Parameters related to instantaneous power failure and under-voltage

Item	Instantaneous power failure	Under-voltage
<ul style="list-style-type: none"> <li>• Always making the inverter trip when an instantaneous power failure/under-voltage occurs</li> </ul>	Set [bb-20] to 0. [E016] Instantaneous power failure error	Set [bb-21] to 0. [E009] Under-voltage error
<ul style="list-style-type: none"> <li>• Always making the inverter retry when an instantaneous power failure/under-voltage occurs</li> </ul>	Set [bb-20] to 255.	Set [bb-21] to 255.
<ul style="list-style-type: none"> <li>• Making the inverter trip after the specified number of retries are made after an instantaneous power failure/under-voltage has occurred</li> </ul>	Set [b-20] to other than 0 or 255. [E016] Instantaneous power failure error	Set [b-21] to other than 0 or 255. [E009] Under-voltage error
<ul style="list-style-type: none"> <li>• Outputting the state to an output terminal</li> </ul>	Assigns 020 [IP] Instantaneous power failure signal.	Assigns 021 [UV] Under-voltage signal.
<ul style="list-style-type: none"> <li>• Selecting whether to make the inverter trip when an instantaneous power failure or under-voltage occurs while the inverter is in a stopped state.</li> </ul>	Sets [bb-27].	



- When selecting a retry function, see "12.3 Using Trip Avoidance Function".
- When the control circuit power supply is turn off and the power is lost, the operation mode will be the same as the mode at power-on. For subsequent operations, see the explanation about the restart after reset.



- When direct current (P-N) is supplied to control power supply terminal R0 and T0, the inverter may detect under-voltage at power interruption and then trip. If there is any problem with your system, set [bb-27] to 00 or 02.
- Even if Selection of instantaneous power failure trip [bb-20] is set to other than 0 and Selection of instantaneous power failure/under-voltage trip during stopping [bb-27] is set to "Disabled" (00 or 02), [E016] Instantaneous power failure error will occur when the actual power failure time exceeds the allowable instantaneous power failure time.
- Even during a retry operation, the retry will be interrupted if the instantaneous power failure/under-voltage condition continues for about 40 seconds, and error code [E009] Under-voltage or [E016] Instantaneous power failure will be displayed.
- When connecting separate power supplies to control power supply terminals (R0 and T0), and if an instantaneous power failure occurs at the main power supply terminals (R, S, and T), it will take about 1 second of the detection time before an instantaneous power failure error and under-voltage error occur. When braking is performed by [AL] alarm signal (output terminal function 017), the braking response will be slow, and therefore use the brake control function.

## ■ Parameter

Item	Parameter	Data	Description
Selection of instantaneous power failure retry	[bb-20]	0~16 / 255	Detects a decrease in the control power supply and restarts the motor when the power supply is recovered. When 0 is specified, the inverter immediately trips when an instantaneous power failure occurs.
Selection of under-voltage retry	[bb-21]	0~16 / 255	Detects a decrease in the main power supply and restarts the motor when the power supply is recovered. When 0 is specified, the inverter immediately trips when an under-voltage condition occurs.
Selection of instantaneous power failure/under-voltage retry	[bb-24]	00	Restarts with 0 Hz at retry.
		01	Restarts with speed matching at retry.
		02	Restarts with frequency pull-in at retry.
		04	Restarts with speed matching at retry, and trips after deceleration stop.
Allowable instantaneous power failure time	[bb-25]	0.3~25.0 (s)	Restarts if the instantaneous power failure is within the set time. Trips if the instantaneous power failure exceeds the specified time.
Retry wait time after instantaneous power failure/under-voltage	[bb-26]	0.3~100.0 (s)	Sets the time before restarting.
Selection of instantaneous power failure/under-voltage trip during stopping	[bb-27]	00	Disabled
		01	Enabled
		02	Disabled during stopping and during deceleration stop after the operation command has been turned off.
Selection of output terminal function	[CC-01]~[CC-05]	017 020 021	017: Outputs [AL] Alarm signal. 020: Outputs [IP] Instantaneous power failure signal 021: Outputs [UV] Under-voltage signal.
Selection of relay output terminal function	[CC-06]		
Selection of relay output terminal function	[CC-07]		

- Alarm output when instantaneous power failure/under-voltage occurs during stopping

**A**

- Use this function to specify whether to output [AL] Alarm signal (error output) (output terminal function 028) when an instantaneous power failure or under-voltage occurs according to [bb-27] Selection of instantaneous power failure/under-voltage trip during stopping.
- Examples 1 to 6 show cases with no retry.



- When the power to control power supply terminals R0 and T0 is supplied from main power supply terminals R, S, and T, and if the control power supply terminals continue to be shut off for 80 ms or more, it is considered as power failure. After the power supply is recovered, the inverter performs power-on operation.
- Depending on the load conditions of the motor driven by the inverter, an under-voltage error [E009], instead of an instantaneous power failure error [E016], may occur.
- The inverter outputs the alarm while the power to control power supply terminals R0 and T0 remains.

- Examples of supplying the power to R0 and T0 from R, S, and T

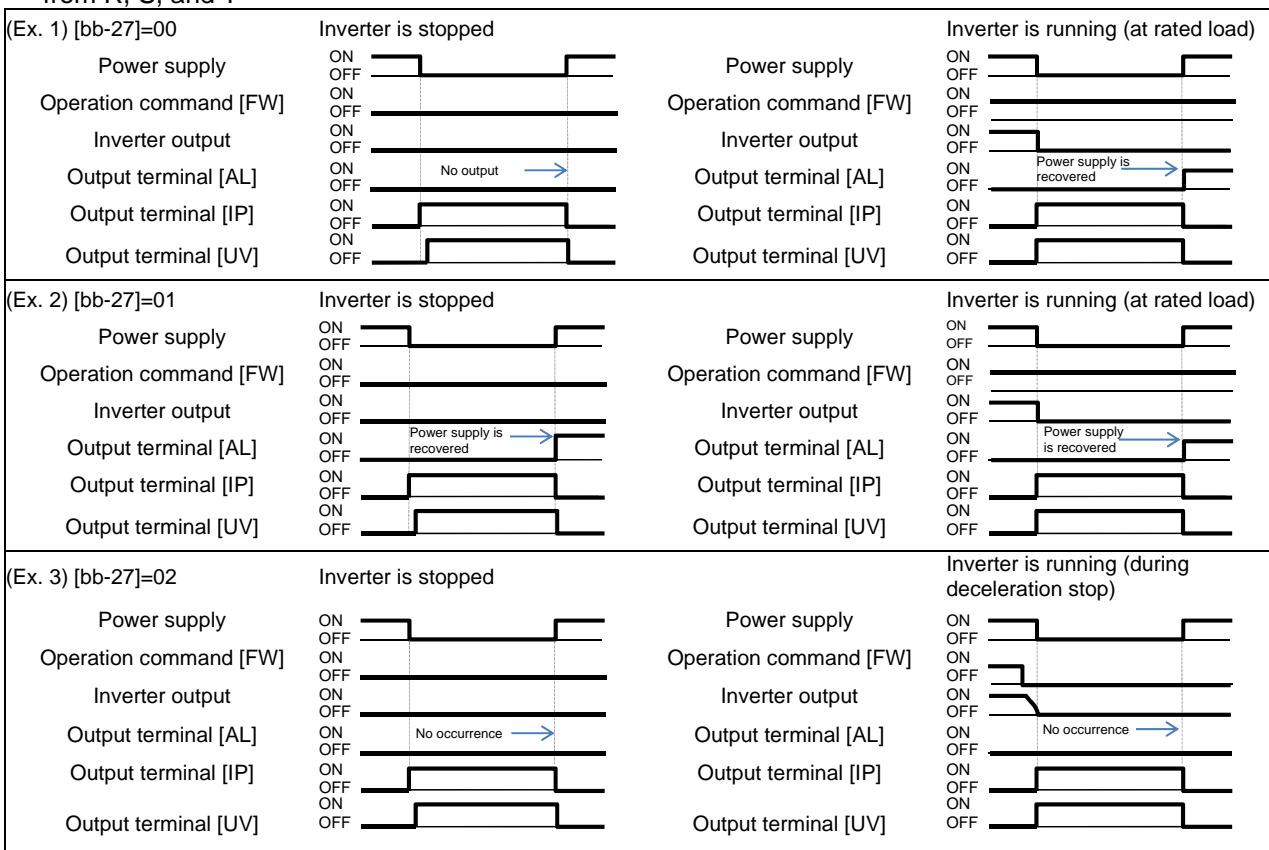



- Depending on the setting for [bb-25] Allowable instantaneous power failure time and the number of retries, the inverter's behavior varies.
- When "0" is specified for the number of retries (Error occurs)  
 Power recovery within [bb-25] Allowable instantaneous power failure time  
 ⇒ An error occurs.  
 Power recovery after [bb-25] Allowable instantaneous power failure time has elapsed  
 ⇒ An error does not occur. The same operation as when the power is turned on.

- When other than "0" is specified for the number of retries (Retry enabled)  
 Power recovery within [bb-25] Allowable instantaneous power failure time  
 ⇒ Retry operation  
 Power recovery after [bb-25] Allowable instantaneous power failure time has elapsed  
 ⇒ An error occurs.

- Examples of supplying the power to R0 and T0 from P and N

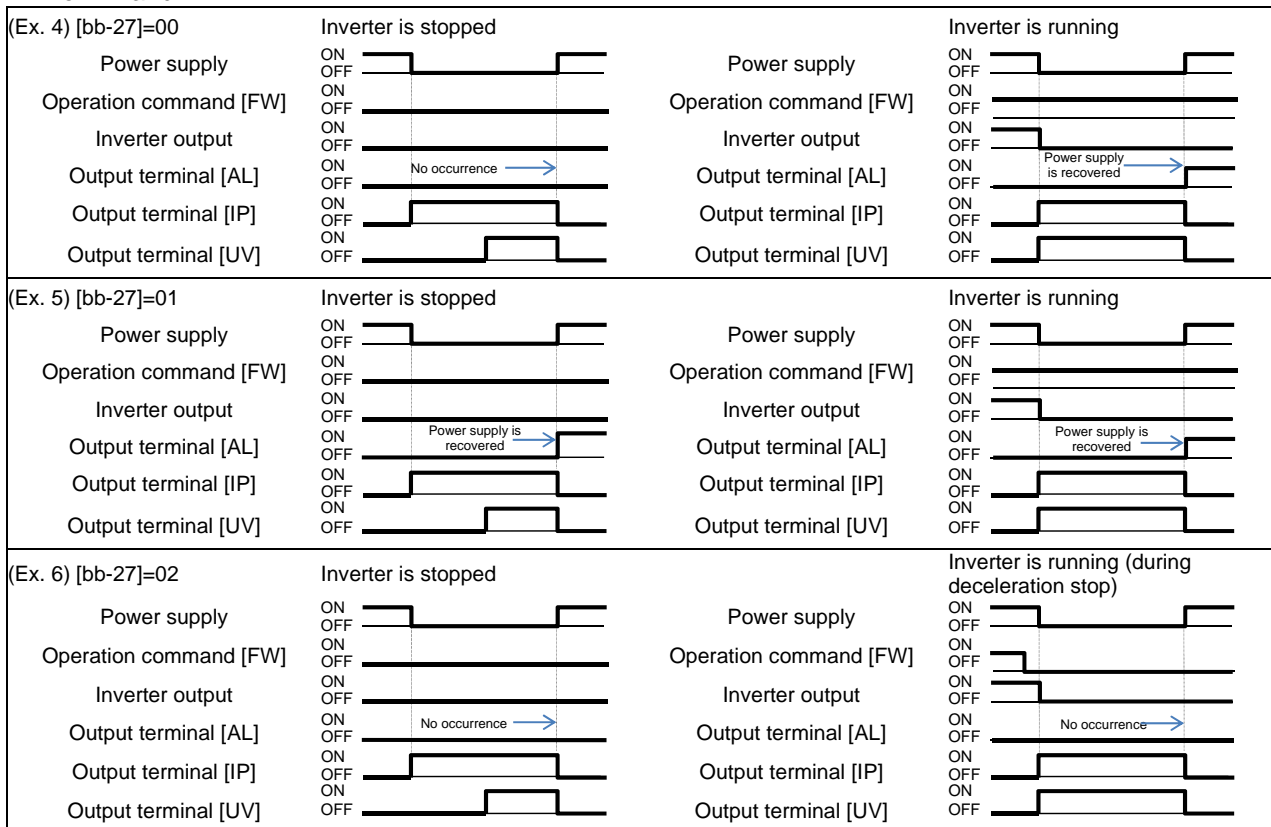

- [IP] signals start to be detected after 3-phase power source has been input to main power supply terminals R, S, and T.
- If direct current is supplied between P and N, [IP] signals will not be output.

**12.16.7** Avoiding mechanical resonance of motor and machine



- Having been assembled to the system, the motor vibrates when operated at a constant speed.



- Use the jump frequency function to operate the inverter while avoiding resonance points on the load-machine system.
- A jump frequency can be set at 3 points.



- The jump frequency function is a function to prevent output within the specified frequency command range. When a frequency command that is within the range of the jump frequency function is input, the output is automatically limited. While the output is limited, the LIM icon will be displayed.
- The output frequency within the range of the jump frequency command fluctuates continuously according to normal the acceleration/deceleration time.

■ Parameter

Item	Parameter	Data	Description
Jump frequency 1	[AG101]	0.00~590.00(Hz)	Sets the center of the frequency range at which to execute a jump. If 0.00 Hz is set, the jump frequency function is disabled.
Jump frequency 2	[AG103]		
Jump frequency 3	[AG105]		
Jump frequency width 1	[AG102]	0.00~10.00(Hz)	Set one-half of the frequency width in which to execute a jump. Frequencies that fall in the range of a jump frequency±jump width will be jumped.
Jump frequency width 2	[AG104]		
Jump frequency width 3	[AG106]		

■ Setting examples

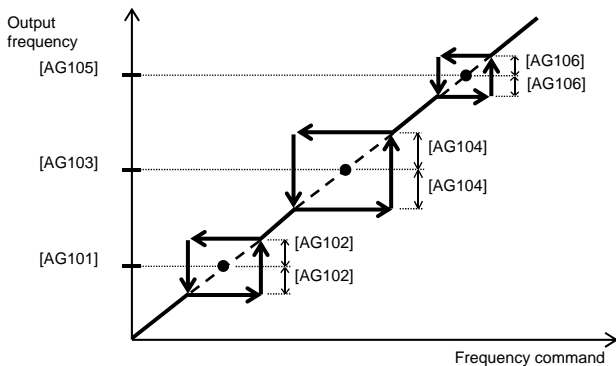

## 12.16.8 Detecting speed deviation error

Q

- How to check whether the system is operating as specified
- How to display an error signal when the motor is not operating as specified.

A

- The speed deviation error detection function judges that the deviation is excessive if the deviation between the frequency command and the feedback speed becomes large.
- This function operates when other than "0.0" is specified for [bb-83] Speed deviation error detection level setting.



- To use this function, speed feedback by the encoder is required.

- Speed deviation is the difference between [dA-12] Output frequency monitor and [dA-08] Detected frequency monitor.
- When the absolute value of speed deviation has exceeded [bb-83] Speed deviation error detection level and [bb-84] Speed deviation error detection time has elapsed, it is judged as a speed deviation error.
- If "00: Warning" is specified for [bb-82] Operation for speed deviation error, the inverter turns on the Output terminal function 041 [DSE] with a speed deviation error.
- If "01: Error" is specified for [bb-82] Operation for speed deviation error, the inverter turns on the Output terminal function 041 [DSE] with a speed deviation error, and trips with [E105] Speed deviation excessive error.

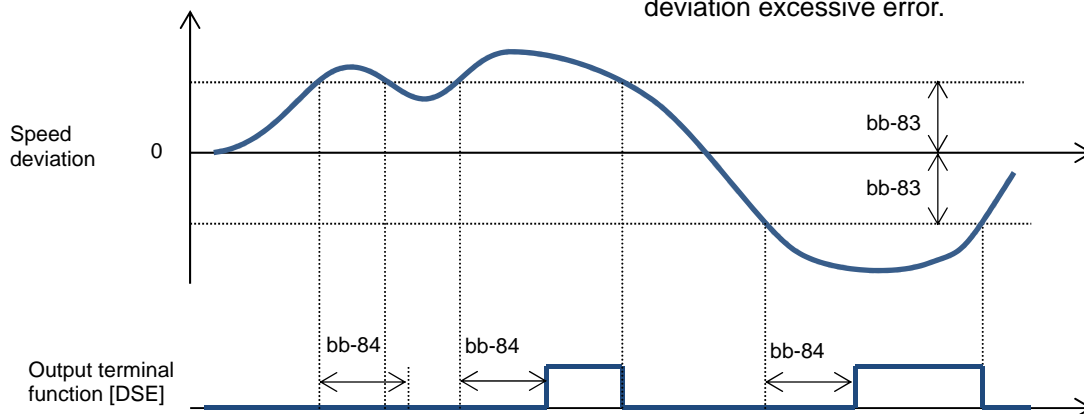

## ■ Parameter

Item	Parameter	Data	Description
Operation for speed deviation error	[bb-82]	00	Turns on the output terminal function 041 [DSE].
		01	Turns on the output terminal function 041 [DSE], and trips with [E105] Speed deviation excessive error.
Speed deviation error detection level setting	[bb-83]	0.0~100.0(%)	Sets the level at which the speed deviation is judged as excessive.
Speed deviation error detection time	[bb-84]	0.0~5.0(s)	Sets the time to judge the deviation to be an error after it has excessively increased.
Detected frequency monitor	[dA-08]	-590.00~590.00(Hz)	Displays data obtained through encoder feedback.
Output frequency monitor	[dA-12]	-590.00~590.00(Hz)	Displays the frequency command given by the inverter.



12.16.9 Detecting over-speed error



- How to monitor whether the motor is rotating at below the maximum speed
- How to display an error signal when the allowable speed of the system is exceeded



- To use this function, speed feedback by the encoder is required.



- The over-speed error detection function judges that the speed is excessive if the feedback speed exceeds the over-speed level.
- This function operates when other than "0.0" is specified for [bb-80] Over-speed error detection level.
- Whether the speed is excessive is determined according to the feedback frequency displayed on [dA-08] Detected frequency monitor.
- When the speed has exceeded [bb-80] Over-speed error detection level and [bb-81] Over-speed error detection time has elapsed, it is judged as an over-speed error.
- When an over-speed error occurs, the inverter trips with [E107] Over-speed error.

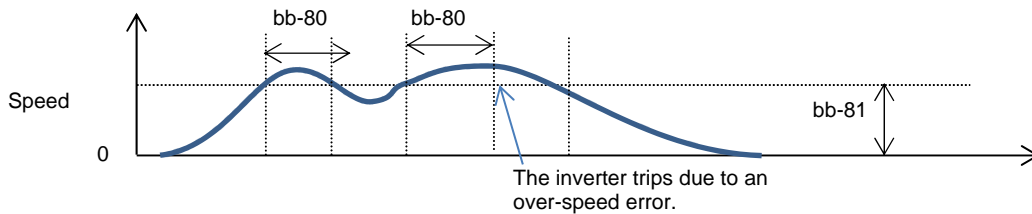

■Parameter

Item	Parameter	Data	Description
Over-speed error detection level setting	[bb-80]	0.0~150.0(%)	Sets the speed level at which the speed is determined to be excessive.
Over-speed error detection time	[bb-81]	0.0~5.0(s)	Sets the time to judge the speed to be an error after it has excessively increased. The inverter trips with [E107] Over-speed error.
Detected frequency monitor	[dA-08]	-590.00~590.00(Hz)	Displays the data obtained through encoder feedback.

## 12.17 Operating the Inverter in Conjunction with the System

### 12.17.1 Using by Switching between Two Settings



- How to drive two types of motors with different settings.
- How to retain the settings for two types of motors separately.
- How to change the settings all together for a batch production.



- This function changes the valid parameters by assigning 024[SET] to the input terminal function and turning it on. In conjunction with [SET], the output terminal 012[SETM] is turned on.
- The following is the notation for the parameters that are changed with the [SET] terminal.

■ Example of the Common Settings

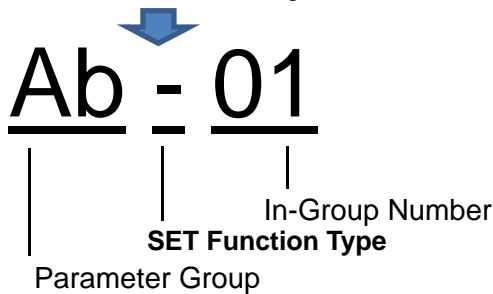

- The [SET] terminal can be switched while the output of the inverter is blocked. If it is being switched during the output, it is switched after the output blockage.
- Even if you want to switch the [SET] terminal for immediate operation, take more than 1 s for the switching time.

■ Example of the First Setting

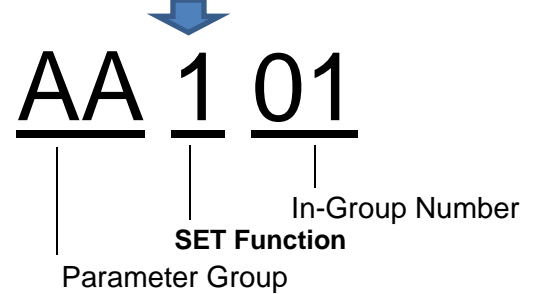

■ Example of the Second Setting

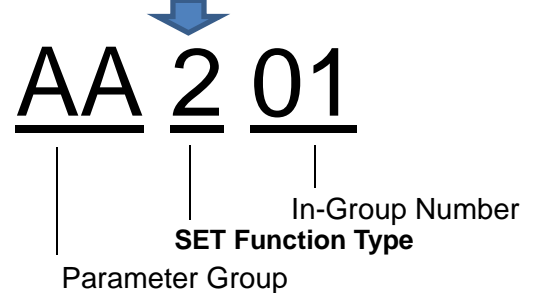

Example)	SET Function Type Notation	Description
Common	The third digit of the parameter is "-": [Ab-01], [bA-30], [CC-01], etc.	The parameter is common to the first and second settings regardless of the SET function. Always valid.
First setting	The third digit of the parameter is "1": [AA101], [bC112], [Hb102], etc.	If the [SET] terminal is off or the [SET] function is not assigned (off), the first setting is applied. The data for which the third digit of the parameter is "1" are all valid.
Second setting	The third digit of the parameter is "2": [AA201], [bC212], [Hb202], etc.	If the [SET] terminal is on, the second setting is applied. The data for which the third digit of the parameter is "2" are all valid.

■ Parameters

Item	Parameter	Data	Description
Input terminal function	[CA-01]~[CA-11]	024	[SET]: Second setting function OFF: The first setting is valid. ON: The second setting is valid. *) If the parameter does not have 024[SET] assigned, the first setting is valid.
Output terminal function	[CC-01]~[CC-07]	012	[SETM]: OFF when SET is OFF; ON when SET is ON.

### 12.17.2 Switching to a Commercial Power Supply (Commercial Switching)



- How to start the motor with the inverter and drive it with a commercial power supply.
- How to switch between the drive with a commercial power supply and drive with the inverter.



- This function can be used to drive the acceleration/deceleration with the inverter and drive in a constant speed with a commercial power supply for a system where the load inertia moment is large.
- If the 035[CS] terminal is turned from on to off with the status where an operation command is sent, the inverter starts with the frequency matched with the motor rotation speed in free-running after the retry waiting time [bb-26]. (Starting the frequency matching.)



- The operation at the [CS] terminal is similar to the case when starting the frequency matching is selected. Starting at 0 Hz may occur when:
  1. The output frequency is equal to or less than one-half of the base frequency.
  2. The induced voltage of the induction motor decays early
  3. The lower limit frequency for the frequency matching [bb-42] is set and a speed not more than the set speed is detected.
- For the frequency matching, extend the retry waiting time [bb-26] when the overcurrent trip occurs.
- The operation can be also restarted automatically when the power is turned on. In this case, the reset restart function is used. For more information, refer to "12.14 Changing the Start Mode".

- For the behavior of the commercial switching, refer to the following sample connection diagram for the commercial switching operation and timing.
- Use light electrical relays for FWY, RVY, and CSY. The following sequence is a reference diagram for timing.

- Take a mechanical interlock for MC3 and MC2. Otherwise, you run the risk of damage to the inverter.
- Since the commercial circuit does not operate either when the earth leakage circuit breaker (ELCB) trips, connect the commercial circuit of another system to MC2 if the backup is required.

Sample connection diagram for the commercial switching operation and timing

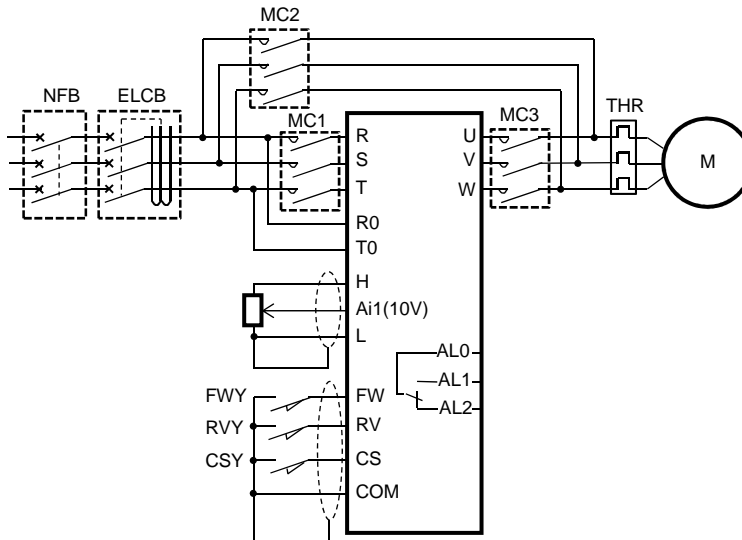

Example of timing from INV to the commercial operation

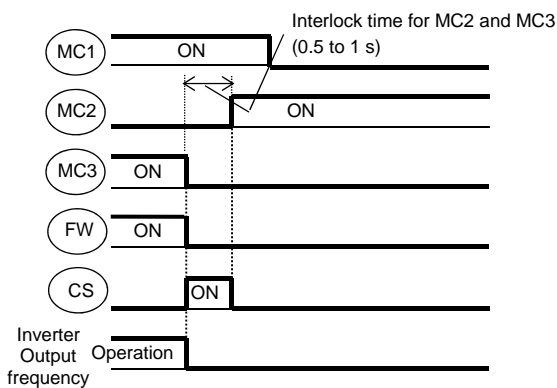

Example of timing from the commercial operation to INV

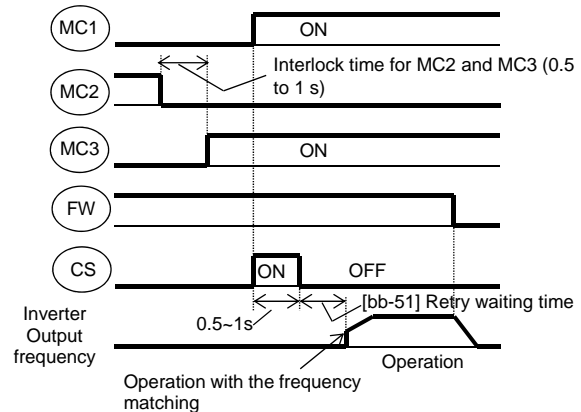

■ Parameters

Item	Parameter	Data	Description
Selecting the input terminal	[CA-01]~[CA-11]	035	Used for the commercial switching [CS].
Instantaneous power failure/undervoltage retry waiting time	[bb-26]	0.3~100.0(s)	Set the waiting time after an operation command.
Setting the lower limit for the speed matching	[bb-42]	0.00~590.00(Hz)	Starting at 0 Hz when the detected value is equal to or less than the set value.

12.17.3 Jogging/Inching Operation

**Q**

- How to drive a motor gradually.
- How to perform an inching operation.

**A**

- This function allows you to fine-tune the position where a motor stops.

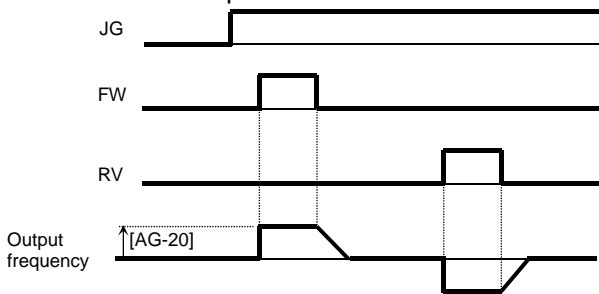

**!**

- The jogging operation is likely to trip due to its direct-on operation. Adjust the setting value for the jogging frequency [AG-20] so that the inverter does not trip.
- For the jogging operation, set the [AA111] operation command selection to 00, turn on the 029[JG] terminal and then put the [FW]/[RV] terminal. The operation is not allowed with the [JG] terminal alone.
- When [AG-21] = 00, 03 for the free-running at the time of the stop, the operation settings for free-running is required.
- When [AG-21] = 02, 05 for the DC-braking at the time of the stop, the settings for the DC-braking function is required. Refer to "12.15 Changing the Stop Mode" respectively.

Parameters

Item	Parameter	Data	Description
Jogging frequency	[AG-20]	Lowest frequency - 10.00 (Hz)	Frequency command at the time of the jogging operation command.
Selecting the jogging stop	[AG-21]	00	Invalid while operating Free-running at the time of the stop.
		01	Invalid while operating Decelerating stop at the time of the stop.
		02	Invalid while operating DC braking at the time of the stop.
		03	Valid while operating Free-running at the time of the stop.
		04	Valid while operating Decelerating stop at the time of the stop.
		05	Valid while operating DC braking at the time of the stop.
Input terminal function	[CA-01]~[CA-11]	029	When the [JG] terminal function is turned on, the jogging behavior occurs at the time of operation.

(Example 1)

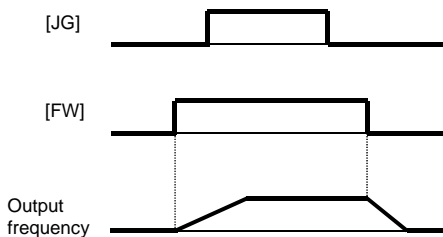

When the setting for the jogging selection [AG-21] is 00, 01 or 02, the jogging behavior does not occur if the [FW] signal is turned on first.

(Example 2)

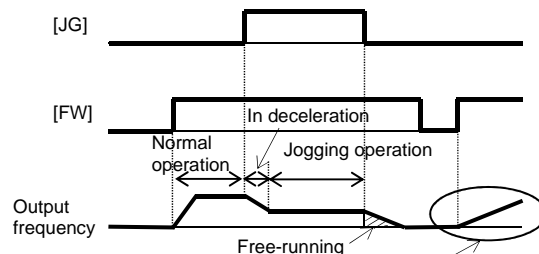

After the free-running is released, acceleration occurs according to the settings for restart [bb-57].

When the setting for [AG-21] is 03, 04 or 05, the jogging behavior occurs if the [FW] signal is turned on first. However, if the [JG] signal is turned off first, the free-running stop occurs.

12.17.4 Performing the Brake Control



- How to perform the operation sequence using a brake.



- Function to control the external brake used in a lifting system, etc. by the inverter. Changing the brake controlling function selection [AF130] enables you to select between two types of control methods.

1. Brake control 1: [AF130] = 01 or 02  
Releases and checks the brake while outputting the frequency.
2. Brake control 2: [AF130] = 03  
Controls the brake in conjunction with the servo lock control.

■ Brake Control 1

- Available in those instances where the operations vary for lifting and lowering since different operations can be set for forward and reverse rotations.
- The 037[BRK] brake release signal for the output terminal function and the 037[BOK] brake check signal for the input terminal function are available.

- [AF130] = 01: For the brake control function, the following parameters are valid.

Item	Valid for both forward and reverse
Brake release establishment waiting time	[AF131]
Acceleration waiting time	[AF132]
Stop waiting time	[AF133]
Brake check waiting time	[AF134]
Brake release frequency	[AF135]
Brake release current	[AF136]
Brake apply frequency	[AF137]



- For using the brake control function, we recommend using controls that generate high torque when the control system [AA121] is started such as:
  - 08: Sensorless vector control,
  - 09: 0 Hz range sensorless vector control or
  - 10: Vector control with sensor.
- When an error occurs in the brake sequence, the inverter trips [E036], the brake control fault signal 038[BER] for the output terminal function is output.
- For the brake control, a trip occurs in the following cases.
  - After the brake release establishment waiting time, the output current was less than the release current.
  - When the brake check signal 037[BOK] is used, [BOK] was not turned on within the brake check waiting time at start-up.
  - When the brake check signal 037[BOK] is used, [BOK] was not turned off within the brake check waiting time at stop.
  - When the brake check signal 037[BOK] is used, the brake release signal 037[BRK] was being output, but [BOK] was turned off.

- [AF130] = 02: For the brake control function (forward/reverse), the following parameters are valid.

Item	Forward rotation side	Reverse rotation side
Brake release establishment waiting time	[AF131]	[AF138]
Acceleration waiting time	[AF132]	[AF139]
Stop waiting time	[AF133]	[AF140]
Brake check waiting time	[AF134]	[AF141]
Brake release frequency	[AF135]	[AF142]
Brake release current	[AF136]	[AF143]
Brake apply frequency	[AF137]	[AF144]

■ Brake Control 1 Function (with the [BOK] Setting)

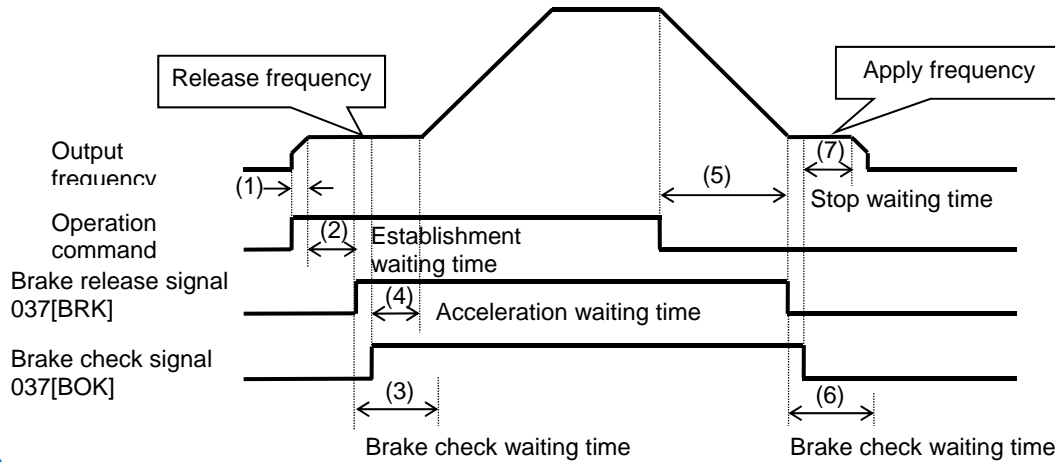

- (1) Once the inverter receives an operation command, it starts the output and accelerate to the release frequency.
- (2) When the brake release establishment waiting time passes after the release frequency is reached, the inverter outputs the brake release signal 037[BRK].



- At this time, if the output current is less than the current set for the release current, the brake release signal is not output and the trip occurs with the [E036] brake error outputting the brake fault signal 038[BER].

- (3) The operation varies depending on whether the brake check signal 037[BOK] is set to the input terminal function.

<b>With [BOK] setting</b>	The inverter turns on the release signal [BRK] and waits for the input (ON) for the check signal [BOK] without accelerating during the brake check waiting time. If the [BOK] is not turned on during the above time, the inverter trips with the [E036] brake error outputting the fault signal [BER].
<b>Without [BOK] setting</b>	After the release signal [BRK] is turned on, the process goes to the item 4 regardless of the brake check waiting time.

- (4) If the brake check signal [BOK] is not selected, when the brake release signal is output, the inverter starts accelerating again to the set frequency after the acceleration waiting time passes.

- (5) Once the operation command is turned off, the inverter decelerates to the brake apply frequency and turns off the brake release signal [BRK].
- (6) The operation varies depending on whether the brake check signal 037[BOK] is set to the input terminal function.

<b>With [BOK] setting</b>	The inverter turns off the release signal [BRK] and waits for the input (OFF) for the check signal [BOK] without decelerating during the brake check waiting time. If the [BOK] is not turned off during the above time, the inverter trips with the [E036] brake error outputting the fault signal [BER].
<b>Without [BOK] setting</b>	After the release signal [BRK] is turned off, the process goes to the item 7 regardless of the brake check waiting time.

- (7) The operation varies depending on whether the brake check signal 037[BOK] is set to the input terminal function.

<b>With [BOK] setting</b>	When the check signal [BOK] is turned off, the inverter decelerates again to 0 Hz after the stop waiting time passes.
<b>Without [BOK] setting</b>	When the release signal [BRK] is turned off, the inverter decelerates again to 0 Hz after the stop waiting time passes.



- If the operation command is the forward command, the parameters on the side of the forward rotation are adopted; if it is the reverse command, those on the side of the reverse rotation are adopted.

### ■ Setting Items Required for the Brake Control 1 Function

Item	Parameter	Data	Description
Brake control function selection	[AF130]	00	Disabled
		01	Brake control enabled *1)
		02	Brake control enabled (forward/reverse set individually)
Brake release establishment waiting time	Forward rotation [AF131]	0.00~5.00(s)	Sets the time after the release frequency is reached until the output current reaches the release current
	Reverse rotation [AF138]		
Acceleration waiting time	Forward rotation [AF132]	0.00~5.00(s)	Sets the mechanical delay time after the release signal is sent until the brake is released
	Reverse rotation [AF139]		
Stop waiting time	Forward rotation [AF133]	0.00~5.00(s)	Sets the mechanical delay time after the release signal is turned off until the brake is closed
	Reverse rotation [AF140]		
Brake check waiting time	Forward rotation [AF134]	0.00~5.00(s)	Set the time not less than the time after the release signal is sent until the release completion signal output from the brake is input to the inverter.
	Reverse rotation [AF141]		
Brake release frequency	Forward rotation [AF135]	0.00~590.0(Hz)	Setting the frequency to output the brake release signal *2)
	Reverse rotation [AF142]		
Brake release current	Forward rotation [AF136]	Inverter rated current x(0.0~2.00)	Setting the output current to allow the brake release *3)
	Reverse rotation [AF143]		
Brake apply frequency	Forward rotation [AF137]	0.00~590.0(Hz)	Setting the frequency to close the brake at the time of stop *2)
	Reverse rotation [AF144]		
Input terminal function	[CA-01]~[CA-11]	037	[BOK] Brake check signal OFF: Brake released ON: Brake applied
Output terminal function	[CC-01]~[CC-07]	037	[BRK] Brake release signal OFF: Brake release command ON: Brake operation command
		038	[BER] Brake fault signal OFF: Brake sequence is normal ON: Brake sequence is abnormal

\*1) If [AF130] = 01, the forward rotation settings, [AF131] to [AF137] are valid for both the forward and reverse rotations.

\*2) Set the time greater than the value of the minimum speed [Hb130].

\*3) Note that a low value for the setting may generate sufficient torque when releasing the brake.



■ Brake Control 2

- The brake control by managing time is available.
- The 037[BRK] brake release signal for the output terminal function and the 037[BOK] brake check signal for the input terminal function are available.
- [AF130] = 03: For the brake control function 2, the following parameters are valid.

Item	Valid for both forward and reverse
Brake release delay time	[AF150]
Brake apply delay time	[AF154]
Brake check time	[AF152]
Servo lock time at start	[AF153]
Servo lock time at stop	[AF154]

■ Brake Control 2 Function

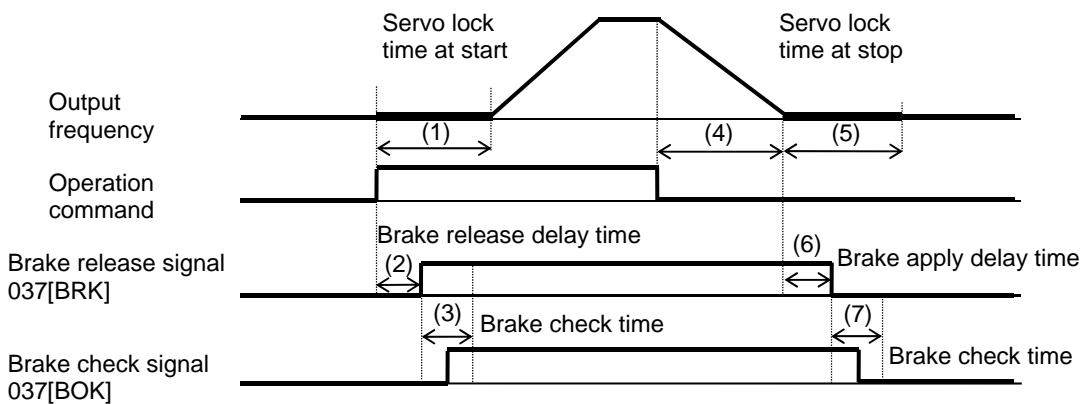

- (1)** The inverter starts the output and performs the servo lock for the servo lock time at start. (If the [AA121] control method is neither 09: zero speed range sensorless vector control nor 10: vector control with sensor, the DC braking is applied.)
- (2)** After the brake release delay time passes, the brake release signal 037[BRK] is turned on.
- (3)** The operation varies depending on whether the brake check signal 037[BOK] is set to the input terminal function. After the servo lock time at start passes, there is an acceleration.

<b>With [BOK] setting</b>	If the 037[BOK] is not turned on during the brake check time, the inverter trips with the [E036] brake error outputting the fault signal 038[BER].
<b>Without [BOK] setting</b>	After the release signal 037[BRK] signal is turned on, there is a waiting for the servo lock time at start to pass.



- Since the brake control 2 generates the servo lock status when the brake is on, use 09: zero speed range sensorless vector control or 10: vector control with sensor for the [AA121] control method.
- Selecting the control methods other than the above will replace the operation part of the servo lock with the DC braking operation.
- For the brake control 2, an error occurs with a trip in the following cases.
  - When the brake check signal 037[BOK] is used, [BOK] was not turned on within the brake check waiting time at start-up.
  - When the brake check signal 037[BOK] is used, [BOK] was not turned off within the brake check waiting time at stop.
  - When the brake check signal 037[BOK] is used, the brake release signal 037[BRK] was being output, but [BOK] was turned off.

- (4)** Once the operation command is turned off, the inverter decelerates and perform the servo lock.
- (5)** The servo lock is kept for the servo lock time at stop.
- (6)** After the brake apply delay waiting time passes, the brake release signal 037[BRK] is turned on.
- (7)** The operation varies depending on whether the brake check signal 037[BOK] is set to the input terminal function. There is a waiting for the servo lock time to pass.

<b>With [BOK] setting</b>	The inverter turns off the release signal 037[BRK], and if the 037[BOK] is not turned off during the brake check time, the inverter trips with the [E036] brake error outputting the fault signal 038[BER].
<b>Without [BOK] setting</b>	After the release signal [BRK] signal is turned off, there is a waiting for the servo lock time at stop to pass.

■ Setting Items Required for the Brake Control 2 Function

Item	Parameter	Data	Description
Brake control function selection	[AF130]	00	Disabled
		01	Brake control 1 enabled
		02	Brake control 1 enabled (forward/reverse set individually)
		03	Brake control 2 enabled
Brake release delay time	[AF150]	0.00~2.00(s)	Set the brake release delay time.
Brake apply delay time	[AF151]	0.00~2.00(s)	Set the brake apply delay time.
Brake check time	[AF152]	0.00~5.00(s)	Set the time to check the brake.
Servo lock time at start	[AF153]	0.00~10.00(s)	Set the servo lock time at start.
Servo lock time at stop	[AF154]	0.00~10.00(s)	Set the servo lock time at stop.
DC braking force at the time of the stop.	[AF105]	0~100(%)	If the control method is neither 09: zero speed range sensorless vector control nor 10: vector control with sensor, the DC braking is applied. Set the braking force (at the time of stop).
DC braking force at the time of the start.	[AF108]	0~100(%)	If the control method is neither 09: zero speed range sensorless vector control nor 10: vector control with sensor, the DC braking is applied. Set the braking force (at the time of start).

### 12.17.5 Performing the Contactor Control

#### Q

- How to perform the operation sequence using a contactor.
- How to involve a contactor on the output side for the control.
- How to save energy by controlling the contactor on the input side.

#### A

- For performing the contactor operation, set the [AF120] contactor control selection to 01.
- The 039[CON] contactor control signal for the output terminal function and the 112[COK] contactor check signal for the input terminal function are available.



- The contactor control requires this function because operating a contactor during the inverter output generates a surge causing damage to the inverter.
- When an error occurs in the contactor sequence, the inverter trips at [E110].
- For the contactor control, a trip occurs in the following cases.
  - When the contactor check signal 112[COK] is used, [COK] is not turned on within the contactor check time at start-up.
  - When the contactor check signal 112[COK] is used, [COK] is not turned off within the contactor check time at stop.
  - When the contactor check signal 112[COK] is used, [COK] is turned off while the contactor control signal 039[CON] is on

#### ■ Setting Items Required for the Contactor Control Function

Item	Parameter	Data	Description
Contactor control selection	[AF120]	00	Disabled
		01	Enabled (primary side) Place a contactor on the primary side of the inverter to reduce standby power.
		02	Enabled (secondary side) Place a contactor on the secondary side of the inverter to implement the function as a brake sequence.
Waiting time at start	[AF121]	0.00~2.00(s)	Set the waiting time from the input of an operation command to the start of the inverter output.
Contactor release delay time	[AF122]	0.00~2.00(s)	Set the time from the output shutoff of the inverter to the control of the contactor.
Contactor check time	[AF123]	0.00~5.00(s)	Set the time from the operation command to the control of the contactor.
Input terminal function	[CA-01]~[CA-11]	112	[COK] Contactor check signal OFF: Contactor released ON: Contactor in operation
Output terminal function	[CC-01]~[CC-07]	039	[CON] Contactor control signal OFF: Contactor release command ON: Contactor operation command

■ Example of Energy Saving on the Primary Side Contactor

(AF120 = 01: Enabled (Primary Side))

- Reduce standby power in combination with the control power supply DC24V input.
- Connecting the auxiliary contact MC for the main circuit power supply to the setting terminal of the output terminal function [CON] shuts off the power input to the inverter main circuit while the inverter output is suspended to implement the operation sequence for energy saving.

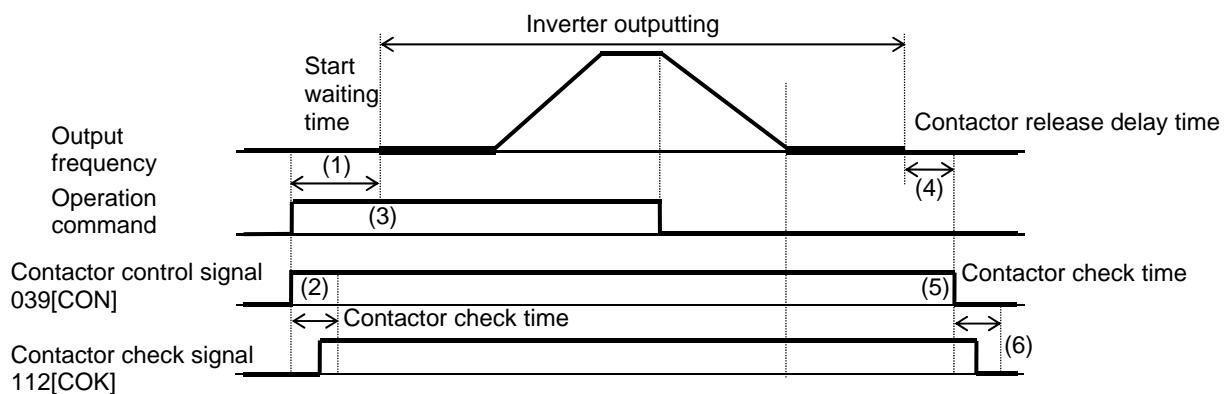
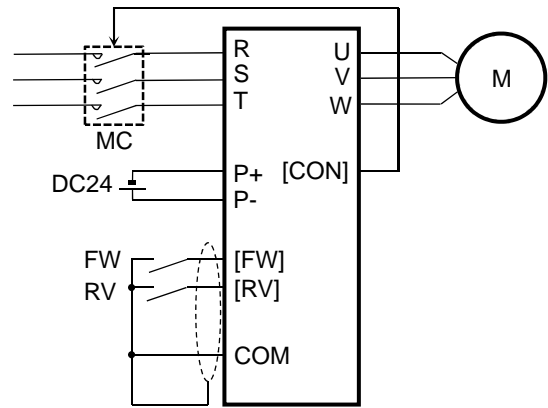

(1) The inverter waits for the output until the start waiting time passes.

(2) It turns on the contactor control signal 039[CON] at the same time. The operation varies depending on whether the contactor check signal 112[COK] is set to the input terminal function.

(4) After the inverter stops the output, there is a waiting time for the contactor release delay time to pass.

(5) After the contactor release delay time passes, the contactor control signal 039[CON] is turned off.

(6) The operation varies depending on whether the contactor check signal 112[COK] is set to the input terminal function.

<b>With [COK] setting</b>	If the 112[COK] is not turned on during the contactor check time, the inverter trips with the [E110] contactor error.
<b>Without [COK] setting</b>	After the contactor control signal 039[CON] is turned on, there is a waiting time for the start waiting time to pass.

<b>With [COK] setting</b>	If the 112[COK] is not turned off during the contactor check time, the inverter trips with the [E110] contactor error.
<b>Without [COK] setting</b>	The inverter still does nothing.

(3) After the start waiting time passes, there is an acceleration.

- Example of the Control on the Secondary Side (AF120 = 02: Enabled (secondary side))
- When Enabled (secondary side) is selected, using in combination with the brake control 2 is available.

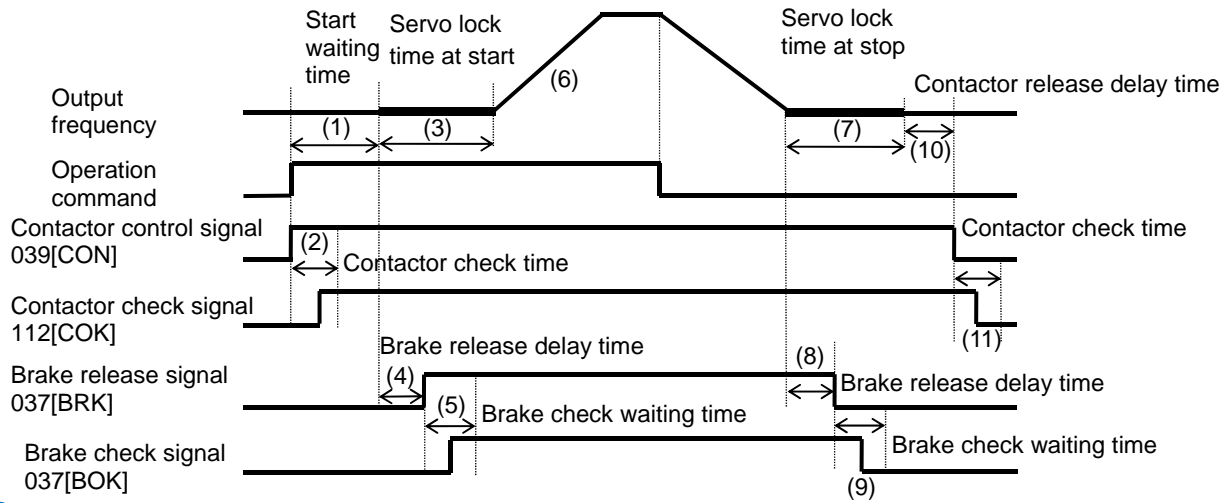

**(1)** Once the operation command is received, the inverter turns on the control signal 039[CON].

**(2)** The operation varies depending on whether the contactor check signal 112[COK] is set to the input terminal function.

<b>With [COK] setting</b>	The inverter turns on the control signal 039[CON] and, if the 112[COK] is not turned on during the contactor check time, the inverter trips with the [Er110] contactor error.
<b>Without [COK] setting</b>	After the control signal 039[CON] is turned on, there is a waiting time for the start waiting time to pass.

**(3)** The inverter starts the output and is in the servo lock status at the present location for the servo lock time at start.

**(4)** After the brake release delay time passes, the brake release signal 037[BRK] is turned on.

**(5)** The operation varies depending on whether the brake check signal 037[BOK] is set to the input terminal function.

<b>With [BOK] setting</b>	If the 037[BOK] is not turned on during the brake check waiting time, the inverter trips with the [E036] brake error outputting the fault signal 038[BER].
<b>Without [BOK] setting</b>	After the release signal 037[BRK] signal is turned on, there is a waiting for the servo lock time at start to pass.

**(6)** After the servo lock time at start passes, there is an acceleration.

**(7)** Once the operation command is turned off, the inverter decelerates and is in the position servo lock status for the servo lock time at stop.

**(8)** After the brake release delay time passes, the brake release signal 037[BRK] is turned off.

**(9)** The operation varies depending on whether the brake check signal 037[BOK] is set to the input terminal function.

<b>With [BOK] setting</b>	The inverter turns off the release signal 037[BRK], and if the 037[BOK] is not turned off during the brake check time, the inverter trips with the [E036] brake error outputting the fault signal 038[BER].
<b>Without [BOK] setting</b>	After the release signal [BRK] signal is turned off, there is a waiting for the servo lock time at stop to pass.

**(10)** The inverter shuts off the output and, after the contactor release delay time passes, the control signal 039[CON] is turned off.

**(11)** The operation varies depending on whether the contactor check signal 112[COK] is set to the input terminal function.

<b>With [COK] setting</b>	If the 112[COK] is not turned off during the contactor check time, the inverter trips with the [E110] contactor error.
<b>Without [COK] setting</b>	The inverter still does nothing.

### 12.17.6 Performing the Forced Operation

#### Q

- How to switch to the forced operation mode with the signal input.
- How to fix an operation mode until the power-off.
- How to enter the operation mode using a commercial power supply when the inverter cannot be restarted due to a failure.

#### A

- Performing this function enables the inverter to run in the forced operation mode (Em-Force mode) in which it operates at a constant speed without shutting off the inverter output until the power-off.
- Set the [PA-01] forced operation to enabled 01 and turn on the [EMF] emergency forced operation terminal (input terminal: 105) to enter the forced operation mode.
- The command for the forced operation mode is set with the [PA-02] Em-Force mode frequency setting and the rotation direction command in the [PA-03] Em-Force mode.



- Once the forced operation mode is turned on, the inverter keeps operating until the power is off.
- When using the forced operation mode, make sure that the system is safe if the operation continues.
- Enabling the overcurrent retry, overvoltage retry, undervoltage retry or instantaneous power failure retry requires a separate setting.
- After the [EMF] emergency forced operation terminal (input terminal: 105) is turned on, the input terminal function except for the following are disabled.

⇒[COK]: Contactor check signal

#### Parameter Setting

Item	Parameter	Data	Description
Em-Force mode selection	[PA-01]	00	Disabled
		01	Enabled
Em-Force mode frequency setting	[PA-02]	0.00~590.00(Hz)	Set the frequency command in the forced operation mode.
Rotation direction in the Em-Force mode	[PA-03]	00	Forward rotation command
		01	Reverse rotation command

#### Input Terminal Setting

Item	Parameter	Data	Description
Selecting the input terminal	[CA-01]~ [CA-11]	105	[EMF] emergency forced operation terminal. OFF: Disabled ON: Forced operation mode (when [PA-01] = 01)

#### Output Terminal Setting

Item	Parameter	Data	Description
Selecting the output terminal	[CC-01]~ [CC-07]	076	[EMFC] Signal in Em-Force. OFF: Disabled ON: In the forced operation mode

Behavior in the Forced Operation



- Turn on the [EMF] emergency forced operation terminal (input terminal: 105) to enter the forced operation mode.
- The inverter performs the output at the frequency set to the [PA-02] Em-Force mode frequency setting and rotation direction set to the rotation direction command in the [PA-03] Em-Force mode until the power-off.

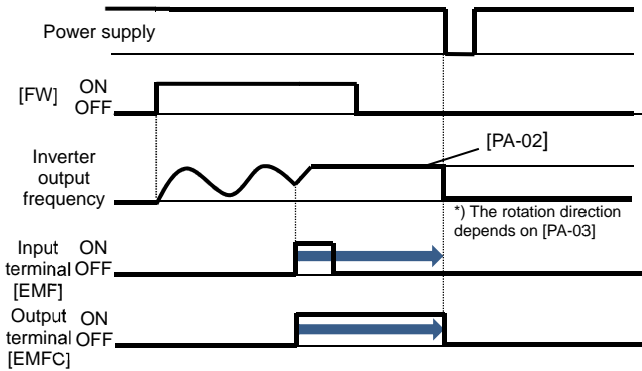

- In the forced operation mode, the following functions are operating automatically.
  - (1) Soft lock status (equivalent to [UA-16] = 01) The parameters can be no longer changed. To restore the settings, turn off [EMF], restore the power and then change the parameters.
  - (2) Auto-reset (equivalent to [bb-10] = 02) When a trip that can be released occurs, the reset is performed automatically to restart.
  - (3) STOP key disabled (equivalent to [AA-13] = 00) Disable the STOP/RESET keys on the operator keypad.
  - (4) Operation enabled during the optional start ([oA-13] = 01, [oA-23] = 01, [oA-33] = 01) The operation is allowed even in the optional start-up.
- The functions except for the above operate according to the settings.

Auto-Reset Behavior in the Forced Operation



- When an error occurs during the forced operation and the inverter trips, the reset equivalent to the one at power-on is performed.

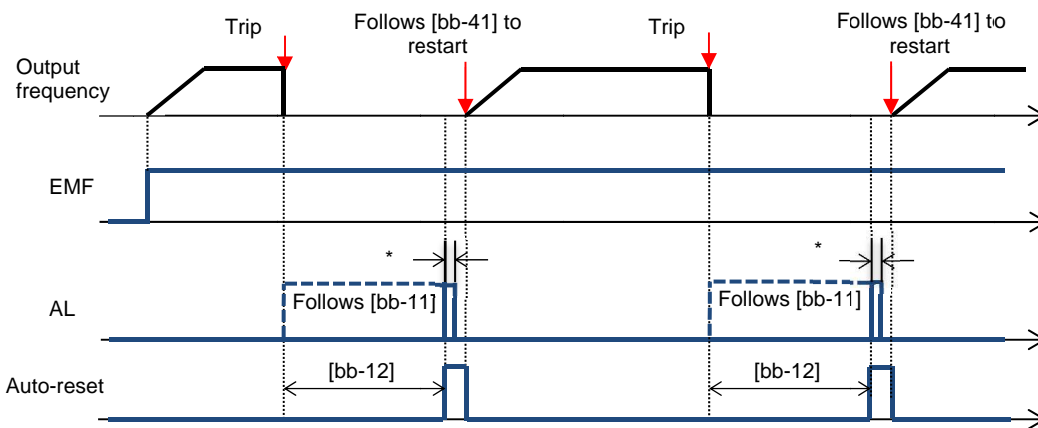

\*000000000For the AL relay terminal, due to the MCU reset (equivalent to Power ON reset), on for a moment no matter what is assigned.

Auto-Reset at the Forced Behavior

(The following parameters themselves are not changed)

Item	Equivalent Parameter	At the Forced Behavior	Description
Auto-reset selection	-	All errors reset in addition to [bb-10]=02	[bb-10]=02 is applied to all errors regardless setting (02: valid executed after the time defined by [bb-12])
Alarm output selection when the auto-reset is enabled	[bb-11]	Follows the setting for [bb-11]	Parameter setting is enabled. However, due to the system reset, AL is turned on for a moment even if AL is set for the output.
Auto-reset waiting time	[bb-12]	Follows the setting for [bb-12]	Parameter setting is enabled.
Auto-reset count setting	[bb-13]	Change to no limit	Forcibly reset an infinite number of times regardless the settings.
Restart after the reset is released	[bb-41]	Follows the setting for [bb-41]	Parameter setting is enabled. For other retry settings ([bb-20] to [bb-31]), the parameter settings are enabled.

■ Switching to the Commercial Operation (Bypass Mode)

**A**

- When the [PA-04] bypass function selection is set to 01: Enabled, switching to the commercial operation mode (bypass mode) is allowed if the specified operation mode is not entered during the forced operation.
- In the bypass mode, [EMBP] bypass mode signal (output terminal: 076) is turned on and the inverter output is shut off.
- For the behavior in the bypass mode, refer to the following sample connection diagram for the commercial switching operation and timing.
- Perform the contactor control based on the [EMBP] bypass mode signal (output terminal: 076).



- For using the bypass mode, it is necessary to implement an interlock taking into consideration the operation delay of the contactor when shifting to the commercial operation. •Make sure that the system operation is safe in using the mode.
- The timing of the contactor control can be taken using the [EMBP] bypass mode signal (output terminal: 076) as the contactor control signal. Take an interlock between the contactor on the commercial power supply side and that on the inverter output side.
- Since the commercial circuit does not operate either when the earth leakage circuit breaker (ELCB) trips, connect the commercial circuit of another system to MC2 if the backup is required.

Sample connection diagram when shifting to the commercial operation and timing

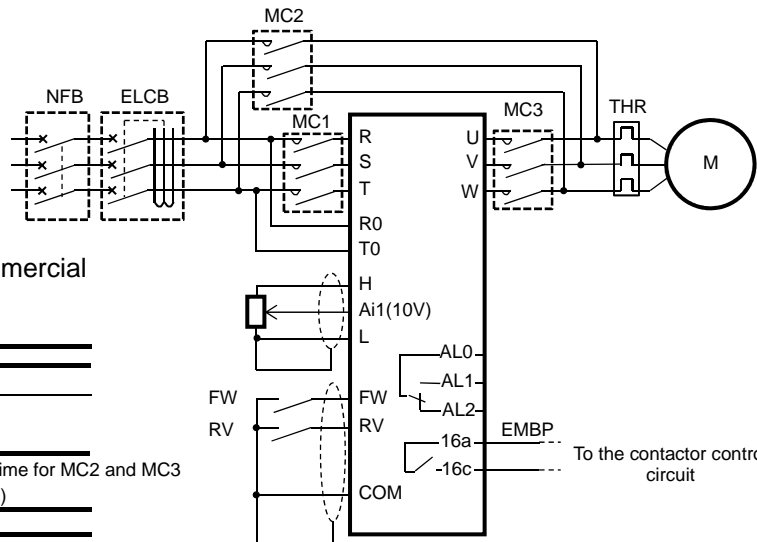

Example of timing from INV to the commercial operation

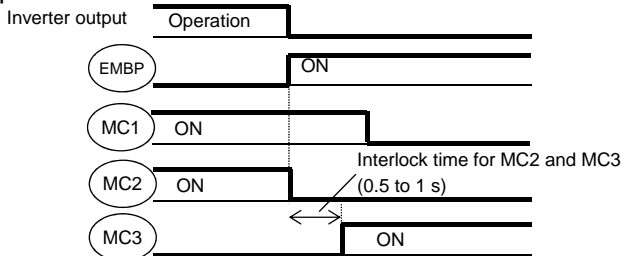

■ Parameter Setting

Item	Parameter	Data	Description
Commercial power supply bypass function selection	[PA-04]	00	Disabled
		01	Enabled
Bypass function delay time	[PA-05]	0.0~1000.0(s)	Set the delay time until the bypass mode operation.

■ Output Terminal Setting

Item	Parameter	Data	Description
Selecting the output terminal	[CC-01]~[CC-07]	076	[EMBP] bypass mode signal. OFF: Disabled ON: In the bypass mode



### Decision for Switching to the Bypass Mode

**A**

- When the [PA-04] bypass function selection is set to 01: Enabled, if the [PA-05] bypass function delay time passes during the forced operation without reaching the Em-Force mode frequency setting [PA-02] and the inverter enters the operation ready incomplete status (output terminal [IRDY] is OFF), it operates in the commercial operation mode (bypass mode).

**!**

- Once the bypass mode is turned on, the inverter keeps shutting off until the power is off.
- While the inverter is operating immediately after the reset, the output terminal [IRDY] is turned off for about a second, however, the bypass mode is not entered for that period.
- When frequency doesn't reach to Em-Force mode frequency setting [PA-02] while upper limiter function is activated, accumulation of delay time is added,

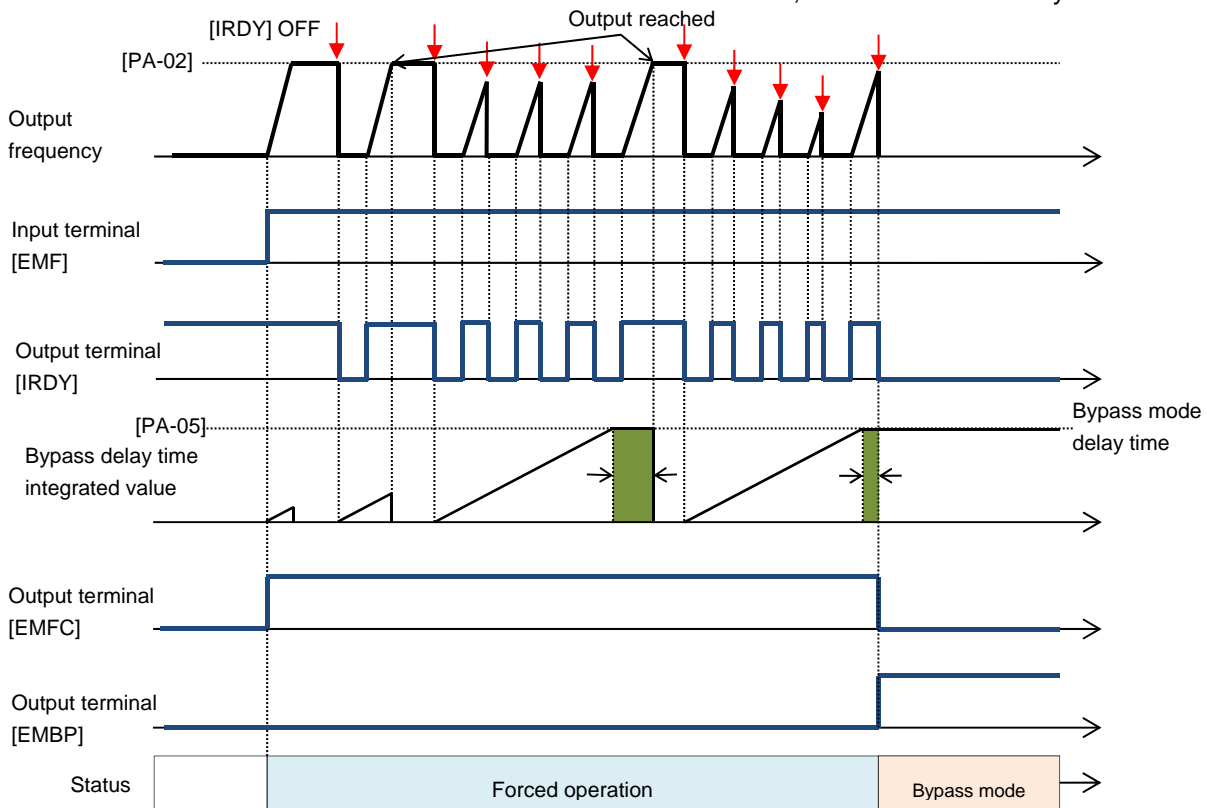

**!**

- In the bypass mode, the following functions are operating automatically.
  - (1) Soft lock status (equivalent to [UA-16] = 01) The parameters can be no longer changed. To restore the settings, turn off [EMF], restore the power and then change the parameters.
  - (2) Auto-reset (equivalent to [bb-10] = 00) Auto-reset is disabled.
  - (3) STOP key disabled (equivalent to [AA-13] = 00) Disable the STOP/RESET keys on the operator keypad.
  - (4) Operation enabled during the optional start ([oA-13] = 01, [oA-23] = 01, [oA-33] = 01) The operation is allowed even in the optional start-up.
- The functions except for the above operate according to the settings.

**12.17.7** Performing the Pulse Train Position Control



- How to input the pulse train to the feedback option to perform the position control.



- The pulse train can be input to the SA/SB terminal of the feedback option (P1-FB) to perform the position control.
- In the position control mode, the acceleration/deceleration time is disabled. (The inverter output is performed following the speed command. (refer to the following right.)) The larger the position loop back gain is, the shorter the acceleration/deceleration time becomes.
- Start the input of the pulse train by assigning the 073[STAT] pulse train position command input permission to the input terminal and turning on the terminal.



- Using this function requires the following settings.
  - [AA121] Control method 10: Vector control with sensor
  - [AA123] Vector control mode
    - 01: Pulse train position control mode
  - [ob-10] Pulse train input SA/SB (P1-FB) mode selection
    - 01: Pulse train position command

The speed command in the pulse train position control mode is calculated by the following formula.

$$\text{Speed} = \frac{P}{2} \times K_v \times \frac{\Delta P}{4 \times \text{ENC}}$$

P: Number of motor poles  
 Kv: Position loop gain  
 ENC: Number of encoder pulses  
 $\Delta P$ : Position deviation

- See also "12.9.17 Use Encoder".

■ Setting Items for the Pulse Train Position Control

Item	Parameter	Data	Description
Control Method	[AA121]	10	Vector control with sensor
Vector control mode selection	[AA123]	01	Pulse train position control mode
Pulse train input SA/SB (P1-FB) detection target selection	[ob-10]	00	Pulse train frequency command
		01	Pulse train position command
Pulse train input SA/SB (P1-FB) mode selection	[ob-11]	00	MD0: 90° phase difference pulse train
		01	MD1: Forward/reverse rotation command + pulse train
		02	MD2: Forward rotation pulse train + reverse rotation pulse train
Electronic gear installation position selection	[AE-01]	00	FB: Feedback side
		01	REF: Command side
Electronic gear ratio numerator	[AE-02]	1~9999	Numerator of th electronic gear
Electronic gear ratio denominator	[AE-03]	1~9999	Denominator of th electronic gear
Positioning completion range setting	[AE-04]	0~10000	Set the value equivalent to encoder 4 multiplication
Positioning completion delay time setting	[AE-05]	0.00~9.99(s)	Set the time from the positioning completion to the output of the [POK] signal.
Position feed forward	[AE-06]	0.00~655.35	Position feed forward gain.
Position loop gain	[AE-07]	0.00~100.00	Position loop gain.
Position bias amount	[AE-08]	-2048~2048	Set the bias value of the position.

## ■ Setting Items for the Pulse Train Position Control

Item	Parameter	Data	Description
Adding frequency	[AA106]	-590.00~590.00(Hz)	Frequency added when the [ADD] terminal is turned on.
Behavior when the position deviation is abnormal	[bb-85]	00	The excessive position deviation signal [PDD] is output.
		01	The output of the excessive position deviation signal [PDD] and the position deviation error [E106] cause a trip.
Abnormal position deviation detection level	[bb-86]	0~65535( $\times 100\mu\text{s}$ )	The level for deciding an abnormal position deviation.
Abnormal position deviation time	[bb-87]	0.0~5.0(s)	Set the time after an abnormal status occurs until the output of [PDD] and error.
Selecting the input terminal	[CA-01]~ [CA-11]	014	ADD: Set speed addition
		072	PCLR: Position deviation clear
		073	STAT: Input permission of the pulse train position command
		074	PUP: Adding the position bias
		075	PDN: Subtracting the position bias
Selecting the output terminal	[CC-01]~ [CC-07]	042	PDD: Excessive position deviation signal
Pulse train position deviation monitor	[dA-26]	-2147483647~ 2147483647	Displays the position deviation for the position command and position feedback.

■ Input Mode for the Pulse Train Position Control

- For more information about the pulse train input mode, refer to the following.

1. MD0: 90° phase difference pulse train

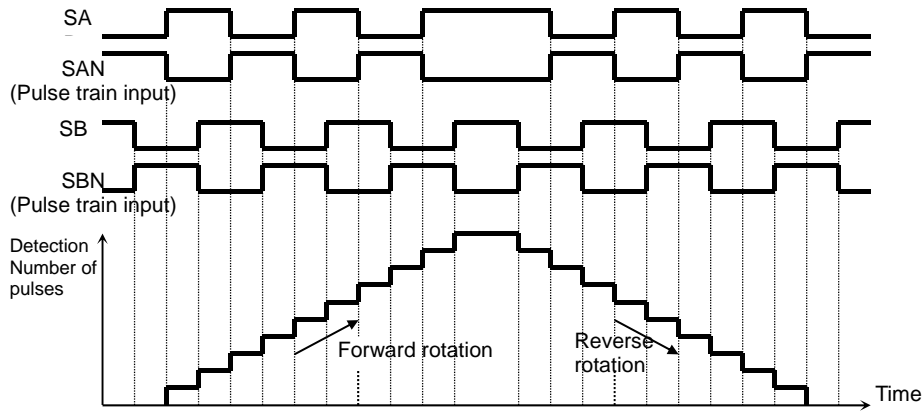

2. MD1: Forward/reverse rotation command + pulse train

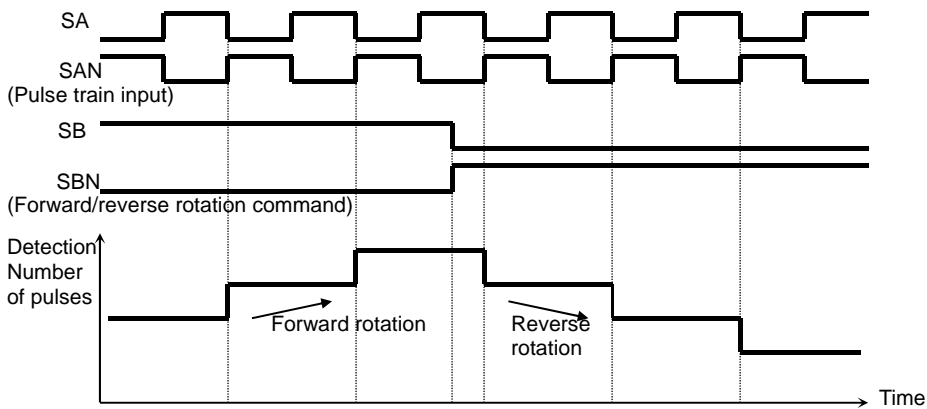

3. MD2: Forward rotation pulse train + reverse rotation pulse train

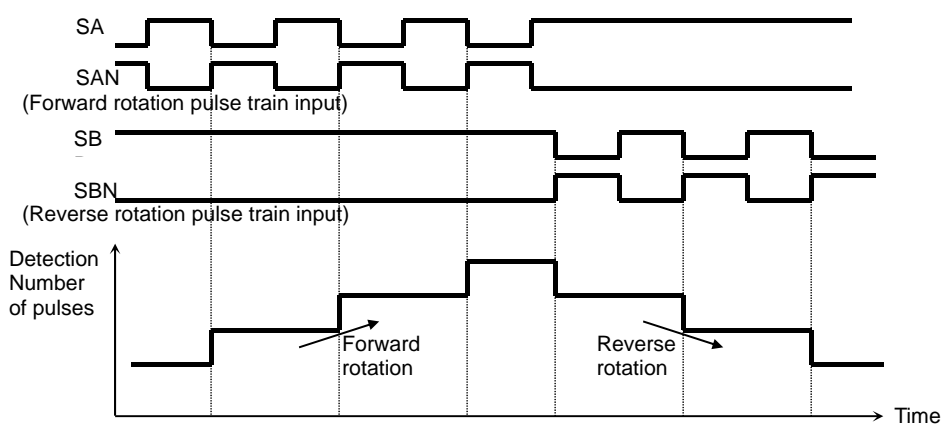

Electronic Gear Function



- This function enables you to set the gain for the position command or position feedback to change the rotation ratio of the main and sub motors when performs the synchronous operation.

[AE-01] = 00 (feedback side)

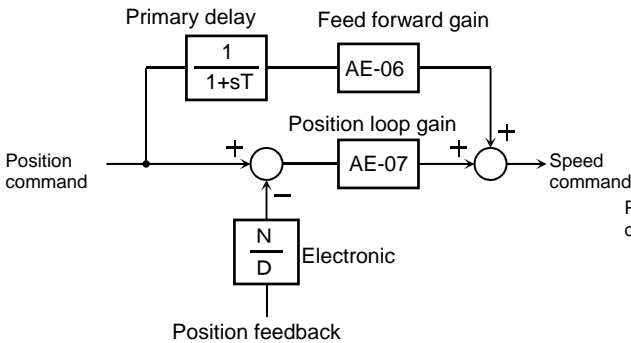

- Make sure that the setting of N/D is in the range of  $1/50 \leq N/D \leq 20$ .  
 N: [AE-02] Electronic gear ratio numerator  
 D: [AE-03] Electronic gear ratio denominator

[AE-01] = 01 (command side)

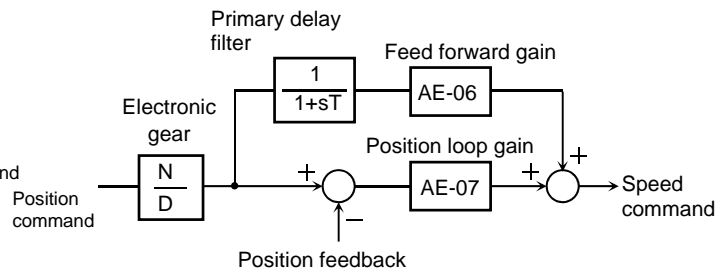

Example of Synchronous Operation between Master and Slave

- The master unit is operable with any control methods ([AA121]).
- The slave unit performs the pulse train position control with vector control. ([AA121]=10,[AA123]=01,[ob-10]=01)
  - Assign the 073[STAT] pulse train position command input permission to an unused input terminal and turn on the terminal. When the 073[STAT] is off, the pulse train input is not accepted.

<Setting Examples>

- Main motor: Number of encoder pulses is 1024
- Sub motor: Number of encoder pulses is 3000
- Main motor rotation speed : sub motor rotation speed = 2 : 1

For the operation with the above conditions, set the following data to the slave unit.  
 [ob-11] Pulse train input mode selection: 00  
 [AE-01] Electronic gear installation position: 01 (REF)  
 [AE-02] Electronic gear ratio numerator: 3000  
 [AE-03] Electronic gear ratio denominator:  $1024 \times 2 = 2048$

- The encoder output [AP][BP][AN][BN] of the main motor is retrieved as the pulse train position command [SAP][SBP][SAN][SBN] of the slave unit.
- When the main motor speed is high, the change amount of the pulse per unit time is getting large and the speed command of the slave unit is also getting large. •When the main motor speed is low, the speed command of the slave unit is also getting small.
- This causes the sub motor follows the main motor to operate.



- If the follow-up response on the slave side is slow, adjust by raising the [AE-06] feed forward gain or [AE-07] position loop gain.

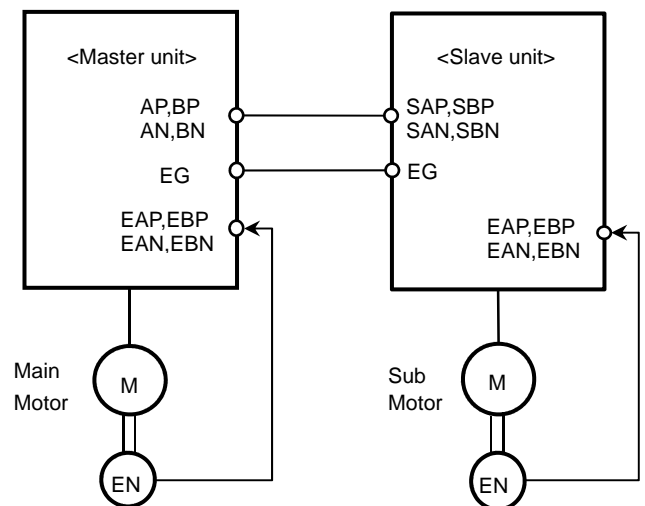

Position Bias Function

**A**

- Used to apply a bias to the position command for the pulse train position control.
  - Add/subtract the set number of pulses to the change amount every 1 ms. Used to adjust the phase of the synchronization point during the synchronous operation, etc.
  - Set the bias amount to the [AE-08] position bias amount.
  - Assign either 074(PUP) or 075(PDN) of the input terminal function.
- The bias amount is added while the PUP terminal is on and is subtracted while the PDN terminal is on.

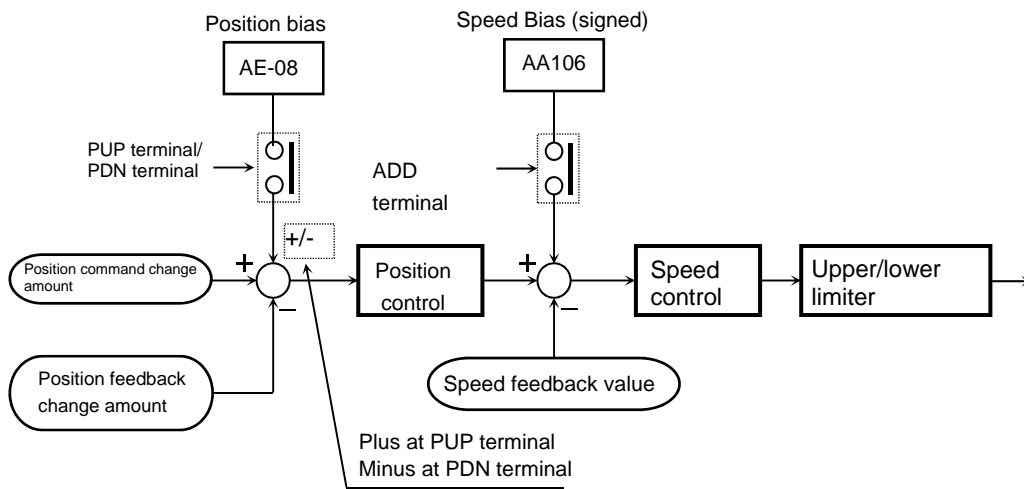

Speed Bias Function

**A**

- The function to apply a speed command bias when the pulse train position control is performed.
- Set the bias amount to the [AA106] adding frequency setting.
- Assign 014(ADD) to any of the input terminal function. The bias amount is added/subtracted to the speed command while the ADD terminal is on.

Detecting Excessive Position Deviation

**A**

- When the [bb-87] abnormal position deviation time passes with the deviation of the position feedback against the position command exceeding the [bb-86] abnormal position deviation detecton level, it is determined to be abnormal.
- The position deviation can be checked with the [dA-26] pulse train position deviation monitor.
- When the behavior of the abnormal position deviation [bb-85] is 00, the output terminal [PDD] is turned on.
- When the behavior of the abnormal position deviation [bb-85] is 01, the output terminal [PDD] is turned on and there is a trip with the [E106] position deviation error.
- The position deviation is cleared with on/off of the input terminal 072[PCLR] position deviation clear or the trip reset.

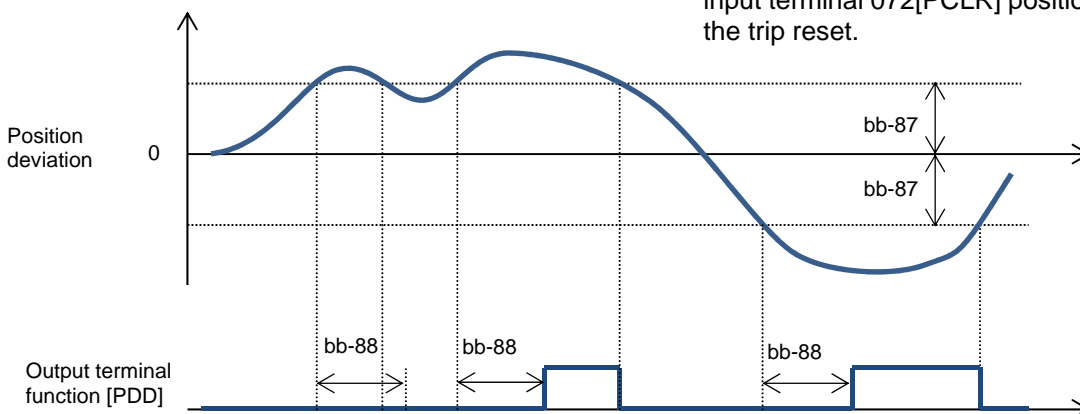

## 12.17.8 Stopping at Designated Position

Q

- How to stop the system at the designated position for the maintenance of a machine tool.
- How to use the orientation function.

A

- The orientation control is available for the pulse train position control.
- Used with the [AA121] control method set to 10: vector control with sensor and the [AA123] vector control mode set to 00: speed torque control mode or 01: pulse train position control mode.
- This function enables you to determine the position at any point within one rotation of the motor. This can be used for replacing the main axis of a machine tool, etc.

!

- For using this function, it is required to set the [AA121] control method to 10: vector control with sensor and use the encoder feedback.
  - See also "12.9.17 Using Encoder".
  - The Z pulse (one rotation position signal) is used as the reference signal for the positioning.
- (1) When the encoder is connected to the P1-FB option:  
Input the Z pulse between EZP-EZN.
  - (2) When the encoder is connected to the control circuit terminal block:  
Assign the input terminal function 109:PLZ to any of the input terminal and input the Z pulse.

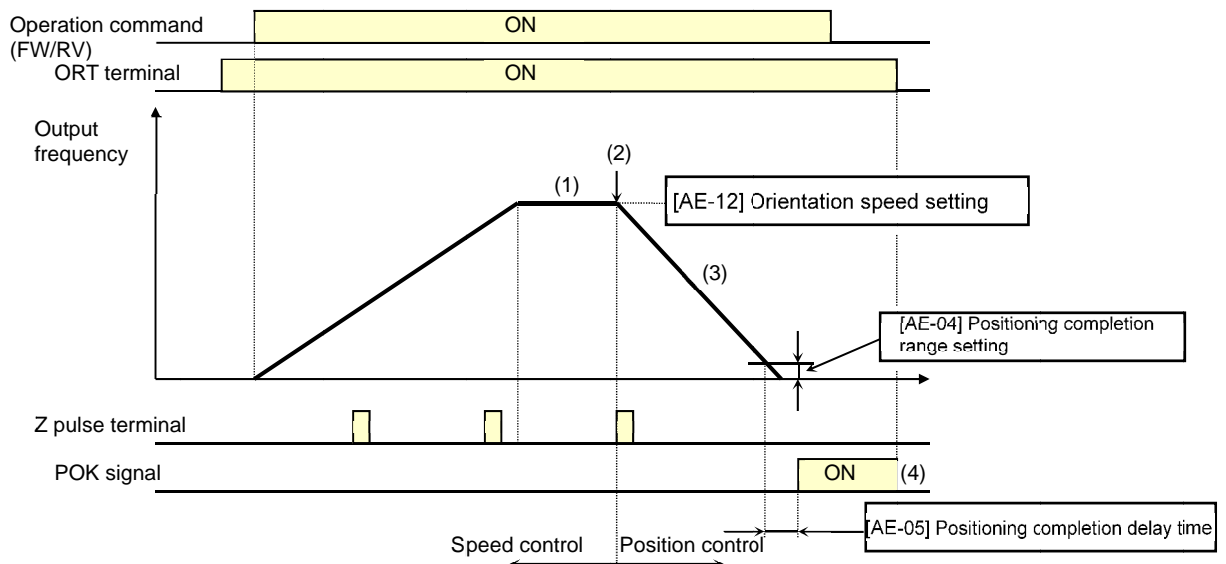

- (1) When the operation command is turned on while the [ORT] terminal is on, there is an acceleration until the [AE-12] orientation speed and a constant speed is entered.  
(During the operation, the speed is shifted to the orientation speed as soon as the ORT terminal is tuned on.)
- (2) After the orientation speed is reached, there is a shift to the position control when the first Z pulse is detected.
- (3) The position control is operated at the [AE-11] orientation stop position + one rotation for the forward rotation and the [AE-11] orientation stop position + two rotations for the reverse rotation as a target value.  
The larger the [AE-07] position loop gain is, the shorter the deceleration time becomes.  
(The deceleration time setting is not followed.)

- (4) When the [AE-05] positioning completion delay time passes after the remaining number of pulses enters the [AE-04] positioning completion range setting, the [POK] signal is output.  
(The output continues until the ORT terminal is turned off.)  
After the positioning completes, the servo lock status continues until the operation command is turned off.

## ■ Parameters

Item	Function Code	Data/Data Range	Description
Control Method	[AA121]	10	Vector control with sensor
Vector control mode selection	[AA123]	00	Speed/Torque control mode
		01	Pulse train position control mode
Pulse train input (internal) Detection target selection	[CA-90]	00	PCNT function
		01	Pulse train frequency command
		02	Speed feedback
		03	Pulse count
Encoder constant setting (main body)	[CA-81]	32~65535	Setting of the number of pulses.
Encoder phase sequence setting (main body)	[CA-82]	00	A phase precedes
		01	B phase precedes
Encoder constant setting (P1-FB)	[ob-01]	32~65535	Setting of the number of pulses.
Encoder phase sequence setting (P1-FB)	[ob-02]	00	A phase precedes
		01	B phase precedes
Orientation Stop position input destination selection	[AE-10]	00	Parameter setting
		01	Option 1
		02	Option 2
		03	Option 3
Orientation stop position	[AE-11]	0~4095	Note 2)
Orientation speed setting	[AE-12]	0.00~120.00(Hz)	Note 1)
Orientation direction setting	[AE-13]	00	Forward rotation side
		01	Reverse rotation side
Positioning completion range setting	[AE-04]	0~10000(pls)	Set the value equivalent to encoder 4 multiplication
Positioning completion delay time	[AE-05]	0.00~10.00(s)	Set the time from the positioning completion to the output of the [POK] signal.
Position control feed forward	[AE-06]	0~655.35	Position feed forward gain.
Position loop gain	[AE-07]	0.00~100.00(rad/s)	Position loop gain.
Input terminal	[CA-01]~[CA-11]	069	ORT: Orientation
		109	PLZ: Pulse train input Z
Output terminal	[CC-01]~[CA-06]	043	POK: Positioning completion
Relay output terminal	[CA-07]		



- Do not set the orientation speed to a high frequency because the deceleration behavior becomes the positioning status within two rotations. The overvoltage protection may cause a trip.
- Set the orientation stop position by dividing one rotation to 4095 (0 to 4095) in the forward rotation direction starting the reference point. (4096 division regardless of the number of pulses for the encoder.)  
The reference point is where the pulse is input between EZP-EZN and the stop target position is located in a layout shown in the diagram to the left from the viewpoint of the motor axis load. (For a positive phase connection)

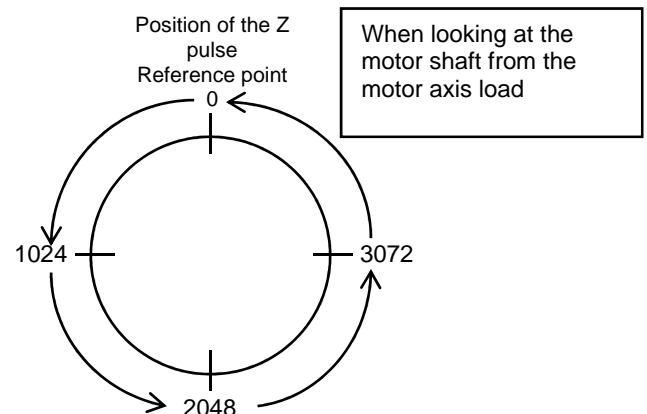



■ Adjustment of Positioning Control

Adjusting the stop position at the positioning operation

Occurrence	Workaround Examples
Stop position is long Position overruns	<ul style="list-style-type: none"> <li>Adjust by increasing [AE-64] by 5%.</li> <li>or</li> <li>Adjust by increasing [AE-65] by 5%.</li> </ul>
Stop position is short Position shortens	<ul style="list-style-type: none"> <li>Adjust by decreasing [AE-64] by 5%.</li> <li>or</li> <li>Adjust by decreasing [AE-65] by 5%.</li> </ul>

■ Parameters

Item	Function Code	Data/Data Range	Description
For calculating the deceleration stop distance Gain	[AE-64]	50.00~200.00(%)	Adjust against the stop distance.
For calculating the deceleration stop distance Bias	[AE-65]	0.00~655.35(%)	Adjust the output frequency for the positioning operation.

Adjusting the control gain at the positioning operation



- Set [AE-66] and [AE-67] to the ratios against the [Hb105] maximum frequency.
- Once the positioning operation is entered, the control starts at the speed set to the [AE-67] APR start speed.
- During the positioning operation, the speed is limited to that set to the [AE-66] APR control speed limit. During the positioning, the acceleration/deceleration time is 0 and the output follows the internal position control results.

- For the positioning operation, specify the stop behavior with the following functions
  - Absolute value control
  - Zero return
  - Orientation
  - SON terminal operation (at position servo)
  - DC braking (at position servo lock control)

Occurrence	Workaround Examples
The follow-up for the positioning stop is bad.	<ul style="list-style-type: none"> <li>Adjust by increasing [AE-07] by 5%.</li> <li>or</li> <li>Adjust by increasing [AE-67] and [AE-66] by 1%.</li> </ul>
An abrupt behavior occurs at the positioning stop.	<ul style="list-style-type: none"> <li>Adjust by decreasing [AE-07] by 5%.</li> <li>or</li> <li>Adjust by decreasing [AE-67] and [AE-66] by 1%.</li> </ul>
An axis vibrates during the stop	<ul style="list-style-type: none"> <li>Adjust by decreasing [AE-07] by 5%.</li> </ul>

■ Parameters

Item	Function Code	Data/Data Range	Description
Position loop gain	[AE-07]	0.00~100.00	Adjust the position loop gain.
APR control speed limit	[AE-66]	0.00~100.00(%)	Limit the output at the positioning.
APR start speed	[AE-67]	0.00~100.00(%)	Set the speed at the positioning start.

### 12.17.9 Controlling at Absolute Position of Origin Reference

Q

- How to perform the absolute position control of the origin reference such as a servo one.

A

- For the absolute position control, there is a move to a target position according to
  - (1) position command,
  - (2) speed command (frequency command),
  - (3) acceleration time, deceleration time, and then the position servo lock status is entered. (The servo lock status is kept until the operation command is turned off.)
- For the frequency command and acceleration/deceleration command at the absolute position control, those selected at that time are followed.
- When the position command is small, there may be the deceleration and then positioning without reaching the speed command value.
- The direction of the operation command (FW, RV) in the absolute position control mode does not have a meaning as the rotation direction. They behave as the signals for operating/stopping. The rotation direction specifies the forward rotation if (target position - current position) is plus and the reverse rotation if minus.
- When the zero return operation (as discussed later) is not performed, if the [AE-61] current position memory at power-off is 00, the position at power-on is treated as the origin (position = 0). •If the [AE-61] is 01, the position at the previous power-off is treated as the (position = 0).
- When the deviation between the position command and current position is 0, if the operation command is turned on, the positioning operation is performed immediately.
- The current position command can be monitored with the [FA-20] position command monitor.



- For using this function, set the [AA121] control method to 10 (vector control with sensor, and set the [AA123] vector control mode selection to 02: absolute position control or 03: high resolution absolute position control.
- This function requires using the encoder feedback
- See also "12.9.17 Using Encoder".
- When the [AA123] vector control mode selection is set to 03: high resolution absolute position control, the control is performed with the 4 multiplication number of pulses used for the internal calculation. (Set the multistage position command and position range designation with the 4 multiplication accuracy.)
- The position command can be switched at a maximum of 16 stages in combination of the input terminals.
- The trip reset or reset signal input does not clear the current position counter.
- When the PCLR terminal is assigned, turning on the PCLR terminal clears the current position counter.
- In the absolute position control mode, the ATR terminal is disabled. (The torque control does not operate.)
- In the absolute position control mode, the STAT terminal is disabled. (The pulse train position control does not operate.)

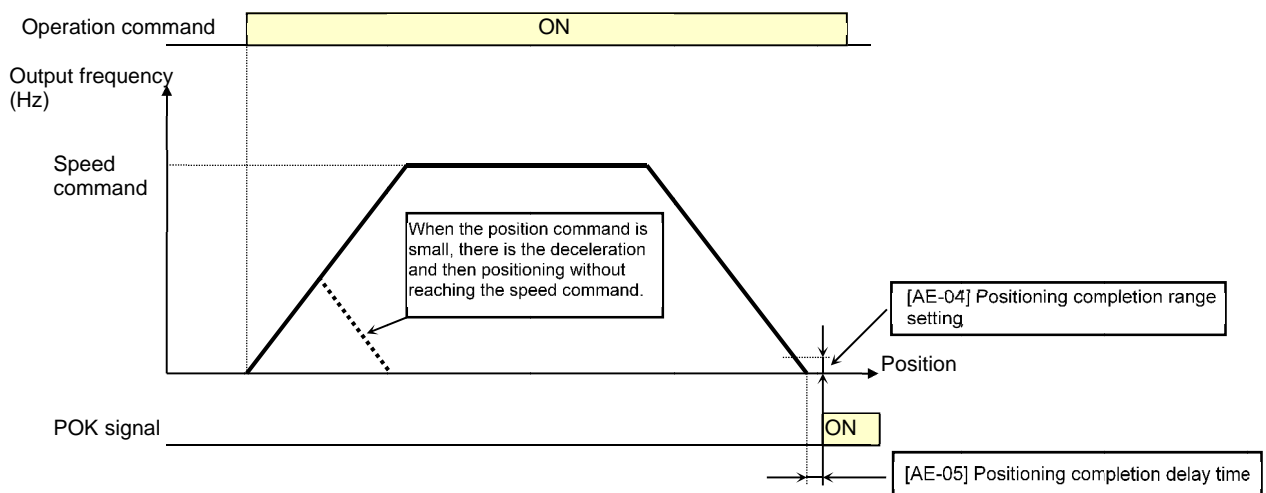

■ Shortest Position Control

- When the [AE-56] positioning mode selection is set to 01 (without limit), the rotation direction is determined so that the moving distance to a target position is the shortest for applications such as a turntable.

Application example) A turntable with eight positioning points

- Assume a case of moving from the current position (1000 pulse) to the target position (6000 pulse).
- When [AE-56] = 00 (with limit), Since (target position) - (current position) = +5000 pulse, the rotation is in the forward direction.
- When [AE-56] = 01 (without limit), the move is in the reverse direction with the shorter moving distance comparing the forward and reverse directions.

Moving distance in the forward direction: +5000 pulse  
 Moving distance in the reverse direction: -3000 pulse

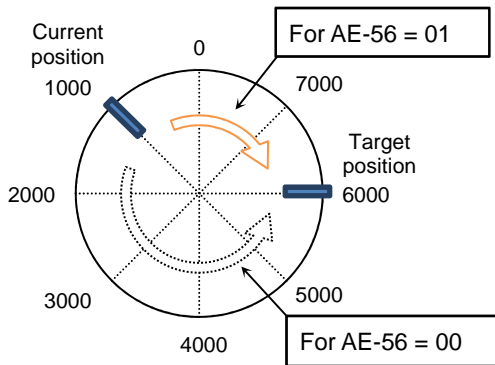

- For the above example, Set the [AE-52] forward rotation side position range designation = 7999 and [AE-54] reverse rotation side position range designation = 0. Also, each positioning point is required to be set in this range.
- Depending on the setting for the position range designation, the following settings are also allowed.  
 [AE-52]=3999  
 [AE-53]=-4000

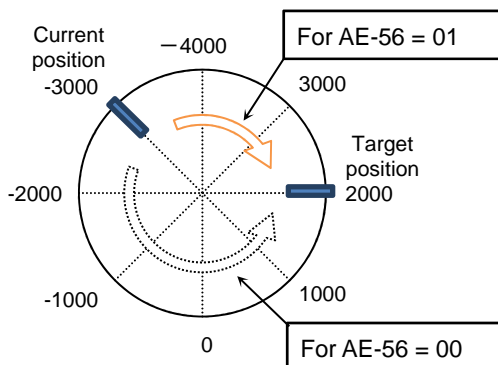

- When [AE-56] = 01, the [E104] position control range error does not occur.
- In the following left case, when moving the position of 7000 pulse to that of 1000 pulse, the forward rotation side position range (7999) is exceeded, however, the current position counter gets back to 0.

**■ Multistage Position Switching Function**

- By combining 076 to 079 ([CP1] terminal to [CP4] terminal), the multistage position commands 0 to 15 can be switched.
- For setting the position command, use the multistage position command 0 to 15 ([AE-20] to [AE-50]).
- When there no terminal assignments, the multistage position command 0 ([AE-20]) becomes the position command.

Position command	CP4	CP3	CP2	CP1
Multistage position 0	OFF	OFF	OFF	OFF
Multistage position 1	OFF	OFF	OFF	ON
Multistage position 2	OFF	OFF	ON	OFF
Multistage position 3	OFF	OFF	ON	ON
Multistage position 4	OFF	ON	OFF	OFF
Multistage position 5	OFF	ON	OFF	ON
Multistage position 6	OFF	ON	ON	OFF
Multistage position 7	OFF	ON	ON	ON
Multistage position 8	ON	OFF	OFF	OFF
Multistage position 9	ON	OFF	OFF	ON
Multistage position 10	ON	OFF	ON	OFF
Multistage position 11	ON	OFF	ON	ON
Multistage position 12	ON	ON	OFF	OFF
Multistage position 13	ON	ON	OFF	ON
Multistage position 14	ON	ON	ON	OFF
Multistage position 15	ON	ON	ON	ON

**■ Speed/Position Switching Function**

- Turn on this terminal when the speed control operation is performed in the absolute position control mode.
- While the 084[SPD] terminal is on, the current position counter is 0. Therefore, when the [SPD] terminal is turned off during the operation, the position control operation starts at that time. (Speed/position switching)

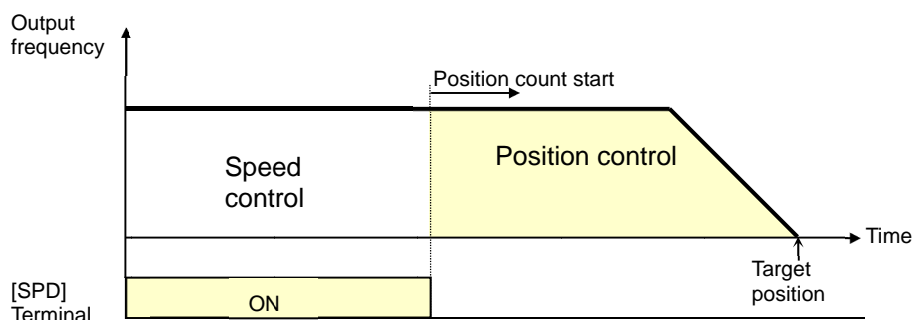

- When inputting the multistage position command, the waiting time until the terminal input is fixed can be set. The transition state before the input is fixed can be prevented from being adopted as the input.
- With the [CA-55] multistage input fixing time, the fixing time can be adjusted. Finally, after the [CA-55] setting time passes without any changes of the input, the data is fixed. (Note that a longer fixing time causes a bad performance of the input response.)

- Example using [CP1] to [CP3] as the input terminals

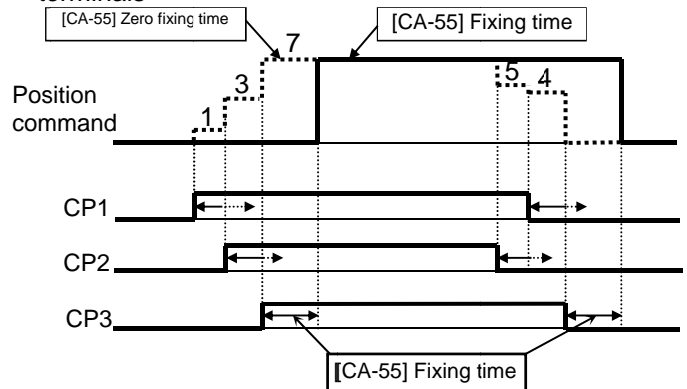

- When switching the speed to position, if the deviation between the position command and current position is 0, the stop operation is performed immediately. (Depending on the position loop gain, there is a possibility of hunting)
- Also, while the [SPD] terminal is on, there is a move in the direction depending on the operation command. For switching the speed to position, note the sign of the command.

■ Teaching Function

- Function to rotate and stop a motor and store the position as a position command at any position command area.
- Assign 110[TCH].  
When the [AA123] vector control mode selection is 02 (absolute position control) or 03 (high resolution absolute position control), the teaching terminal is functioning.

- (1) Select the position command to set at the [AE-60] teaching selection.
- (2) Operate the work.
  - Enter the operation command while the [TCH] terminal is on. • For the speed command and acceleration/deceleration command at this time, those selected at that time are followed.

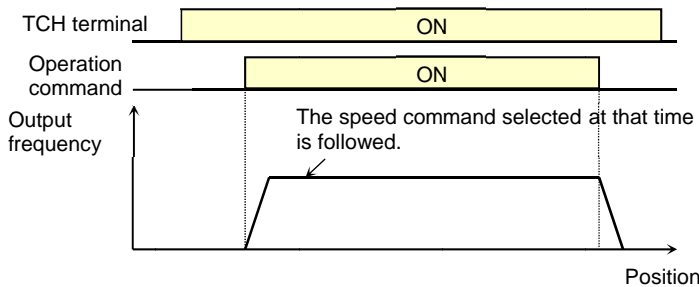

- (3) Once the desired position is reached, press the save (2 key) on the operator keypad.
- (4) The current position is set in the area corresponding to the position command destination set to the [AE-60] teaching selection. (However, [AE-60] itself is not saved. After power-off or the reset, it becomes 00 (X00).)

[AE-60] setting value	Position command to be set
00	[AE-20]: Multistage position command 0
01	[AE-22]: Multistage position command 1
02	[AE-24]: Multistage position command 2
03	[AE-26]: Multistage position command 3
04	[AE-28]: Multistage position command 4
05	[AE-30]: Multistage position command 5
06	[AE-32]: Multistage position command 6
07	[AE-34]: Multistage position command 7
08	[AE-36]: Multistage position command 8
09	[AE-38]: Multistage position command 9
10	[AE-40]: Multistage position command 10
11	[AE-42]: Multistage position command 11
12	[AE-44]: Multistage position command 12
13	[AE-46]: Multistage position command 13
14	[AE-48]: Multistage position command 14
15	[AE-50]: Multistage position command 15



- If the power supply of the inverter control circuit (R0,T0) is input, the teaching is allowed. Since operating the work with an external unit, etc. also enables the current position counter to work, the teaching is allowed even if the operation is performed without an inverter.



- However, make sure that the power supply of the inverter power circuit (R, S, T) is shut off. •Or make sure that the connection between the output of the inverter (U, V, W) and the motor is shut off. Otherwise, you run the risk of injury and damage.

Zero Return Function

**A**

- With the [AE-70] zero return mode selection, three types of zero return operations are performed. Once the zero return completes, the current position is cleared (= 0).

- The direction of the [AE-71] zero return is selected with the zero return direction selection.
- When the zero return is not performed, the position at power-on follows the [AE-61] current position memory at power-off and the position control is performed.

Low Speed Zero Return ([AE-70] = 00)

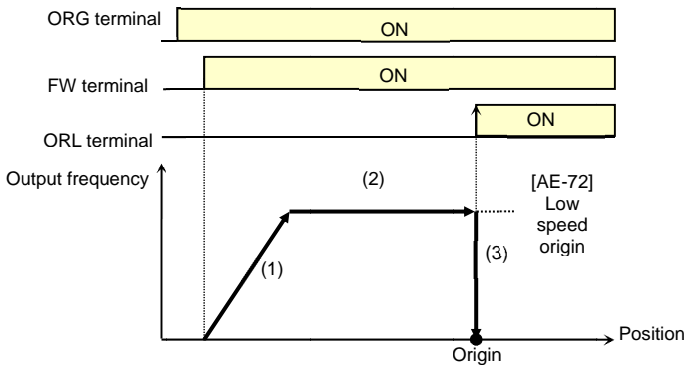

- (1) Follows the acceleration time to accelerate to the low speed zero return speed.
- (2) Operates at the low speed zero return speed.
- (3) Positioning when the ORL signal is input.

High Speed Zero Return 1 ([AE-70] = 01)

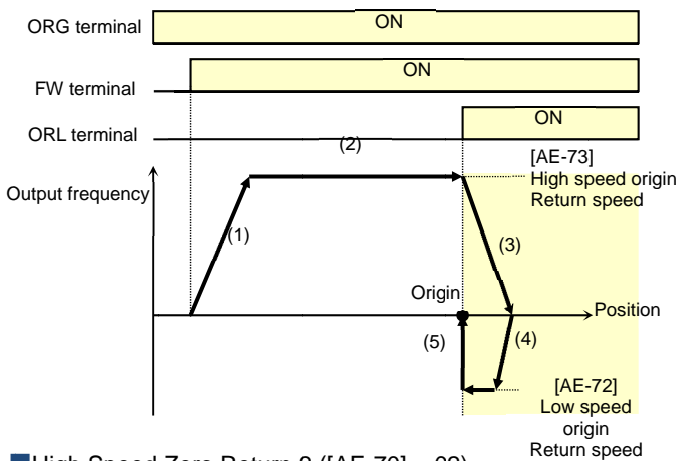

- (1) Follows the acceleration time to accelerate to the high speed zero return speed.
- (2) Operates at the high speed zero return speed.
- (3) Starts the deceleration when the ORL signal is turned on.
- (4) Operates in the reverse rotation direction at the low speed zero return speed.
- (5) Positioning when the ORL signal is turned off.

High Speed Zero Return 2 ([AE-70] = 02)

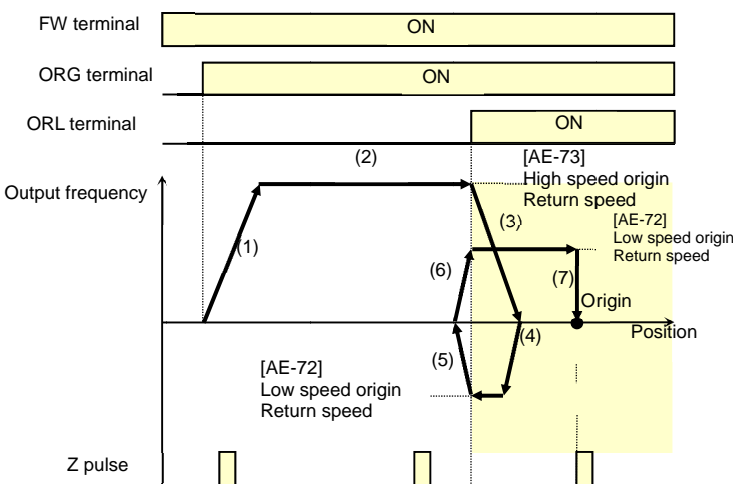

- (1) Follows the acceleration time to accelerate to the high speed zero return speed.
- (2) Operates at the high speed zero return speed.
- (3) Starts the deceleration when the ORL signal is turned on.
- (4) Operates in the reverse rotation direction at the low speed zero return speed.
- (5) Starts the deceleration when the ORL signal is turned off.
- (6) Operates in the forward rotation direction at the low speed zero return speed.
- (7) Positioning at the first Z pulse after the ORL signal is turned on.

### ■ Forward/Reverse Drive Stop Function (FOT/ROT)

- Function to prevent the operation range from being deviated using the signal from the control range limit switch.
- The torque limit is restricted to 10% on the forward rotation side when the 082[FOT] terminal is input and on the reverse rotation side when the 083[ROT] terminal is input. This is applicable as the limit switch at the edge of the machine.

### ■ Position Range Designation Function

- Specify the position control range at the [AE-52] position range designation (forward rotation side) / [AE-54] position range designation (reverse rotation side).
- When the current position counter exceeds this setting, there is a trip with the position control range error (E104) and the inverter becomes the free-running status.

### ■ Position Memory at Power-Off

- By setting the [AE-61] current position memory at power-off to 01, the current position data at power-off can be stored.
- Use this for the application where the shaft of the motor is locked at power-off.



- For the machine of which the shaft idles at power-off, there is likely to be a gap between the stored position and the current position when the power is turned on again.

### ■ Position Data Preset

- When the 085[PSET] terminal is turned on, the current position counter (can be monitored with [dA-20]) is overwritten with the value set to the [AE-62] preset position data.
- Available for restarting in the middle of the positioning process, etc. (Data is overwritten at the ON edge of the [PSET] terminal.)

### ■ Position Control Related Parameters

Item	Function Code	Data/Data Range	Description
Control Method	[AA121]	10	Vector control with sensor
Vector control mode selection	[AA123]	02	Absolute position control
		03	High resolution absolute position control
Multistage position command 0	[AE-20]	[AE-54]~[AE-52]	Set the position command for the multistage speed command to each.
Multistage position command 1	[AE-22]	[AE-54]~[AE-52]	
Multistage position command 2	[AE-24]	[AE-54]~[AE-52]	
Multistage position command 3	[AE-26]	[AE-54]~[AE-52]	
Multistage position command 4	[AE-28]	[AE-54]~[AE-52]	
Multistage position command 5	[AE-30]	[AE-54]~[AE-52]	
Multistage position command 6	[AE-32]	[AE-54]~[AE-52]	
Multistage position command 7	[AE-34]	[AE-54]~[AE-52]	
Multistage position command 8	[AE-36]	[AE-54]~[AE-52]	
Multistage position command 9	[AE-38]	[AE-54]~[AE-52]	
Multistage position command 10	[AE-40]	[AE-54]~[AE-52]	
Multistage position command 11	[AE-42]	[AE-54]~[AE-52]	
Multistage position command 12	[AE-44]	[AE-54]~[AE-52]	
Multistage position command 13	[AE-46]	[AE-54]~[AE-52]	
Multistage position command 14	[AE-48]	[AE-54]~[AE-52]	
Multistage position command 15	[AE-50]	[AE-54]~[AE-52]	
Position range designation (forward rotation side)	[AE-52]	Condition 1: 0 to +268435455 Condition 2: 0 to +1073741823	Condition 1: Except for the condition 2 Condition 2: [AA121] = 10, [AA123] = 03
Position range designation (reverse rotation side)	[AE-54]	Condition 1: -268435455 to 0 Condition 2: -1073741823 to 0	Condition 1: Except for the condition 2 Condition 2: [AA121] = 10, [AA123] = 03
Position command monitor	[FA-20]	Condition 1: -268435455 to +268435455 Condition 2: -1073741823 to +1073741823	Condition 1: Except for the condition 2 Condition 2: [AA121] = 10, [AA123] = 03

■ Position Control Related Parameters

Item	Function Code	Data/Data Range	Description
Positioning mode selection	[AE-56]	00	With limit
		01	Without limit
Teaching selection	[AE-60]	00	Multistage position command 0 (AE-20)
		01	Multistage position command 1 (AE-22)
		02	Multistage position command 2 (AE-24)
		03	Multistage position command 3 (AE-26)
		04	Multistage position command 4 (AE-28)
		05	Multistage position command 5 (AE-30)
		06	Multistage position command 6 (AE-32)
		07	Multistage position command 7 (AE-34)
		08	Multistage position command 8 (AE-36)
		09	Multistage position command 9 (AE-38)
		10	Multistage position command 10 (AE-40)
		11	Multistage position command 11 (AE-42)
		12	Multistage position command 12 (AE-44)
		13	Multistage position command 13 (AE-46)
		14	Multistage position command 14 (AE-48)
15	Multistage position command 15 (AE-50)		
Current position at power-off memory	[AE-61]	00	Disabled
		01	Enabled
Preset position data	[AE-62]	Condition 1: -268435455 ~+268435455 Condition 2: -1073741823 ~+1073741823	Condition 1: Except for the condition 2 Condition 2: [AA121] = 10, [AA123] = 03
Reset selection	[CA-72]	02	Enabled Only at Trip (On to Release)
		03	Enabled Only at Trip (Off to Release)
Input terminal function	[CA-01]~[CA-11]	072	PCLR: Position deviation clear
		076	CP1: Position command selection 1
		077	CP2: Position command selection 2
		078	CP3: Position command selection 3
		079	CP4: Position command selection 4



## ■ Zero Return Related Parameters

Item	Function Code	Data/Data Range	Description
Zero return mode selection	[AE-70]	00	Low speed zero return
		01	High speed zero return 1
		02	High speed zero return 2
Zero return direction selection	[AE-71]	00	Forward rotation
		01	Reverse rotation
Low speed zero return speed	[AE-72]	0.00~10.00(Hz)	Speed in the low speed zero return mode.
High speed zero return speed	[AE-73]	0.00~590.00(Hz)	Speed in the high speed zero return mode.
Input terminal function	[CA-01]~[CA-11]	072	PCLR: Position deviation clear
		076	CP1: Position command selection 1
		077	CP2: Position command selection 2
		078	CP3: Position command selection 3
		079	CP4: Position command selection 4
		080	ORL: Origin limit signal
		081	ORG: Zero return start signal
		082	FOT: Forward rotation drive stop
		083	ROT: Reverse rotation drive stop
		084	SPD: Speed/position switching
		085	PSET: Position data preset
110	TCH: Teaching		

12.17.10 Servo Locking a Motor

**Q**

- How to fix the position controlling axis.
- How to lock a motor while it stops using vector control.

**A**

- This function makes a motor the servo lock status with the servo lock terminal [SON] command.
- Assigning the input terminal function 054[SON] triggers this function.

- For the [AA115] stop method selection is 00

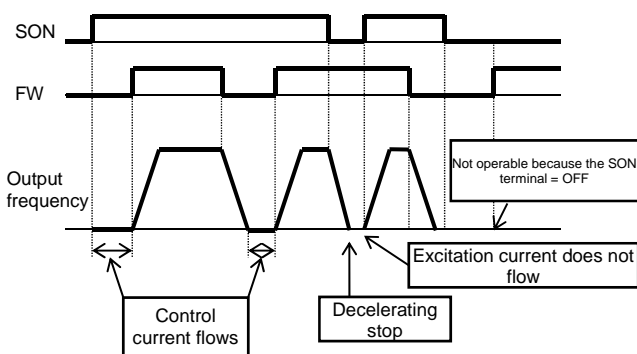

**!**

- This is valid when the control method [AA121] is 09: IM 0 Hz range sensorless vector control or 10: IM vector control with sensor.
- When [SON] is assigned to the input terminal function, the operation is not accepted unless [SON] is turned on.
- During the operation, when [SON] is turned off, there is an operation according to the [AA115] stop method selection. If the free-running occurs, the settings for the restart after releasing the free-running is followed at the time of restart.
- When the backup excitation function [FOC] is assigned to the input terminal, the servo lock function [SON] does not operate.

- For the [AA115] stop method selection is 01

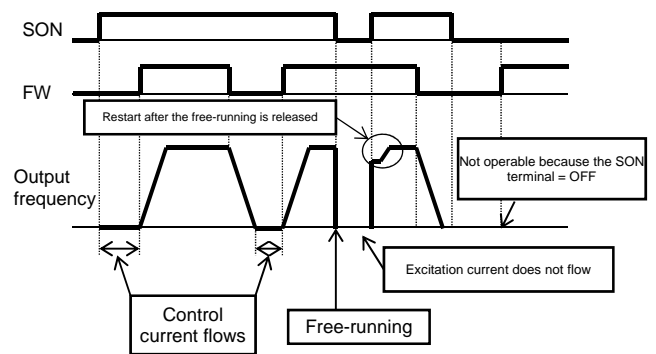

Parameters

Item	Parameter	Data	Description
Input terminal function	[CA-01]~[CA-11]	054	Servo lock function [SON]
Stop method selection	[AA115]	00	Perform the deceleration stop when the operation command is off.
		01	Perform the free-running when the operation command is off.
Restart after the free-running is released	[bb-40]	00	Perform the 0 Hz restart.
		01	Perform the frequency matching restart. 1)
		02	Perform the frequency pull-in restart. 2)
Instantaneous power failure/undervoltage retry waiting time	[bb-26]	0.3~100.0(s)	Set the waiting time after an operation command.

\*1) Refer to "12.14.3 Starting by picking up frequency".

\*2) Refer to "12.14.4 Starting with frequency pull-in".

**!**

- If the torque at the time of start is insufficient, it may be improved by adjusting the starting boost amount [HC111][HC112] or speed response [HA115]. Refer to "12.9 Select motor control method in accordance with motor and load".

- If the torque at the time of start is insufficient, it may be improved by using the torque bias function. Refer to "12.11.6 Operate by Adding Torque Command".

(Memo)

## 12.18 Controlling the Cooling Fan of the Inverter

### 12.18.1 Selecting the Operation of the Cooling Fan



- How to run the cooling fan of the inverter all the time
- How to cool the inverter only while it is operating
- How to stop the sound of the inverter while it is not operating
- How to cool the inverter only when it is generating heat



- [bA-70] Setting the selection of the cooling fan operation allows you to set the operation of the cooling fan.
- For [bA-70]=00, the cooling fan runs all the time.
- For [bA-70]=01, the cooling fan runs when the inverter becomes the output status. The fan runs for three minutes after the operation stops.
- For [bA-70]=02, the cooling fan runs depending on the temperature of the head sink detected by the inverter.



- When the instantaneous power failure or power-off occurs while the cooling fan is running, it is suspended regardless of the [bA-70] cooling fan operation, and automatically resumes after the restoration of power.

#### Parameters

Item	Parameter	Data	Description
Selection of the Cooling Fan Operation	[bA-70]	00	Running all the time: The fan runs all the time.
		01	Running in operation: The fan runs automatically when the inverter becomes the operating status. The fan continuously runs for three minutes after the operation stops and then automatically stops. * The cooling fan runs when the head sink temperature of the inverter exceeds 60°C. If the head sink temperature is under 50°C for more than three minutes, the cooling fan is allowed to be stopped.
		02	Running depending on the temperature: The cooling fan runs when the head sink temperature of the inverter exceeds 40°C. If the head sink temperature is under 40°C for more than three minutes, the cooling fan automatically stops.



- For checking the head sink temperature, see "13.9.1 Checking the Head Sink Temperature".
- For the replacement timing of the cooling fan, see "13.11.1 Checking the Life Cycle Monitor".



## 12.19 How to output a warning signal to a terminal

### 12.19.1 Outputting an alarm signal



- I want to detect the error state of the inverter and make a notification to the system.



- Assign the output terminal function 017 [AL] alarm signal to one of [CC-01] to [CC-07] that corresponds to the output terminal and output the signal.
- The [AL] function is assigned in the initial state to the contact c relay [CC-07] of AL1-AL0 and AL2-AL0.

#### Alarm relay AL

- The operations of AL1-AL0 and AL2-AL0 are as follows.

[CC-17]	Control power	Inverter error output	Output terminal state	
			AL1-AL0	AL2-AL0
00	On	Abnormal	Close	Open
		Normal	Open	Close
01	Off	-	Open	Close
		Abnormal	Open	Close
01	On	Abnormal	Open	Close
		Normal	Close	Open
01	Off	-	Open	Close
		Abnormal	Open	Close

- The specifications of the relay contacts AL1-AL0 and AL2-AL0 are as follows.

		Resistive load	Inductive load
AL1-AL0	Maximum contact capacity	AC250V,2A DC30V,3A	AC250V,0.2A DC30V,0.6A
	Minimum contact capacity	AC100V,10mA DC5V,100mA	
AL2-AL0	Maximum contact capacity	AC250V,1A DC30V,1A	AC250V,0.2A DC30V,0.2A
	Minimum contact capacity	AC100V,10mA DC5V,100mA	



- If the system recognizes an interruption of the inverter power supply as an error, this symptom may be alleviated by changing the wiring and the selection of contacts.

- You can set the output specifications of contacts a and b to output terminals 11-15, relay output terminals 16A-16C, AL1-AL0, and AL2-AL0 individually.

#### Relay output 16C

- The operations of 16C are as follows.

[CC-16]	Control power	Functional operation	Output terminal state
00	On	ON	Close
		OFF	Open
01	Off	-	Open
		On	Open
01	On	ON	Open
		OFF	Close
01	Off	-	Open
		On	Open

- The specifications of the relay contact 16C are as follows.

		Resistive load	Inductive load
16C	Maximum contact capacity	AC250V,2A	AC250V,1A
	Minimum contact capacity	AC250V,1mA	

■ Parameter

Item	Parameter	Data	Description
Output terminal function selection 11-15	[CC-01]~[CC-05]	017	An alarm signal is output to the output terminal to which 017 [AL] has been assigned. ON: When an alarm has occurred OFF: When no alarm has occurred
Relay output terminal function selection 16A-16C	[CC-06]		
Relay output terminal function selection AL1-AL0/AL2-AL0	[CC-07]		
Output terminal function selection	[CC-11]~[CC-15]	00	Operates as contact a (NO).
		01	Operates as contact b (NC).
1a relay output terminal function selection a/b (NO/NC) selection	[CC-16]	00	Operates as contact a (NO).
		01	Operates as contact b (NC).
1c relay output terminal function selection a/b (NO/NC) selection	[CC-17]	00	See the table at the upper left.
		01	

**A**

- Contact a:  
The contact closes when the functional operation is ON and opens when OFF.
- Contact b:  
The contact closes when the functional operation is OFF and opens when ON.

Example: [E001] occurred when the current reached the overcurrent level.

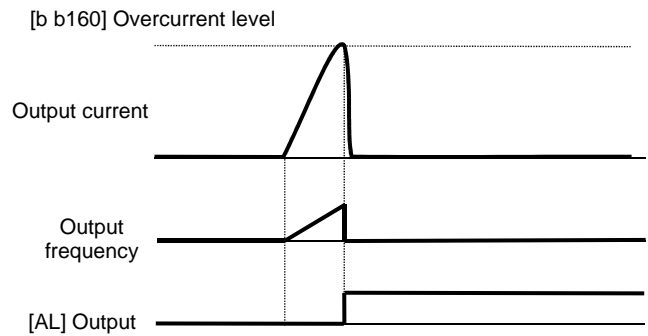

### 12.19.2 Outputting a serious fault signal



- I want to detect the unrecoverable error state of the inverter and make a notification to the system.



- The inverter hardware may have a fault when this signal is output. Check the error history and deal with the situation appropriately.



- Assign the output terminal function 018 [MJA] serious fault signal to one of [CC-01] to [CC-07] that corresponds to the output terminal and output the signal.
- Trips that are evaluated as serious faults are as follows.

Error code	Name	Description
E008	Memory element error	The memory element of the inverter is under an abnormal condition.
E010	Current detector error	The current detector of the inverter is under an abnormal condition.
E011	CPU error	The drive CPU of the inverter is under an abnormal condition.
E014	Ground fault error	The inverter has a ground fault.
E019	Temperature detector error	The temperature detector of the inverter is under an abnormal condition.
E020	Cooling fan rotation speed reduction error	The cooling fan rotation speed of the inverter has reduced, preventing the inverter from dissipating heat.

#### Parameter

Item	Parameter	Data	Description
Output terminal function selection 11-15	[CC-01]~[CC-05]	018	The signal will be output when a serious fault error occurs in the output terminal to which 018 [AL] has been assigned. OFF: No serious fault has occurred. ON: A serious fault has occurred.
Relay output terminal function selection 16A-16C	[CC-06]		
Relay output terminal function selection AL1-AL0/AL2-AL0	[CC-07]		



## 12.19.3 Outputting the trip type



- I want to detect the error type of the inverter and make a notification to the system.



- Assign the output terminal functions 084 [AC0] to 087 [AC3] alarm code to one of [CC-01] to [CC-07] that corresponds to the output terminal and output the signal.
- Assign 084 [AC0] to 087 [AC3] to the output terminal functions [CC-01] to [CC-07].
- The 4-bit output mode is selected when 087 [AC3] is assigned to the output terminal function, whereas the 3-bit output mode is selected when it is not assigned.
- The table below shows the alarm codes to be output.



- The output state switches depending on whether 087 [AC3] has been set to [CC-01] to [CC-07]. The 4-bit output mode is selected when 087 [AC3] has been set, and the signals 084 [AC0], 085 [AC1], 086 [AC2], and 087 [AC3] will be output in accordance with the table below even when all of them have not been set.
- The signals will be output in the 3-bit mode when one of or any pair from 084 [AC0], 085 [AC1], and 086 [AC2] have been set. The signals 084 [AC0], 085 [AC1], and 086 [AC2] will be output in accordance with the table below even when all of them have not been set.

## ■ Parameter

Item	Parameter	Data	Description
Output terminal function selection 11-15	[CC-01]~[CC-05]	084~087	084: [AC0] alarm code 0 085: [AC1] alarm code 1 086: [AC2] alarm code 2 087: [AC3] alarm code 3 The signal is output when a trip occurs at the output terminal assigned.
Relay output terminal function selection 16A-16C	[CC-06]		
Relay output terminal function selection AL1-AL0/AL2-AL0	[CC-07]		

■ Trip code

Output terminal function				When a 4-bit code is selected (with [AC3])		When a 3-bit code is selected (without [AC3])	
AC3	AC2	AC1	AC0	Cause code	Trip description	Cause code	Trip description
0	0	0	0	Normal	Normal	Normal	Normal
0	0	0	1	E001	Overcurrent error	E001	Overcurrent error
0	0	1	0	E005,E038, E039	Motor overload error, low-speed range overload error, controller overload error	E005,E038, E039	Motor overload error, low-speed range overload error, controller overload error
0	0	1	1	E007,E015	Overvoltage, incoming overvoltage error	E007,E015	Overvoltage, incoming overvoltage error
0	1	0	0	E009	Undervoltage error	E009	Undervoltage error
0	1	0	1	E016	Momentary interruption error	E016	Momentary interruption error
0	1	1	0	E030	IGBT error	E030	IGBT error
0	1	1	1	E006	Braking resistor overload error	-	Other than above
1	0	0	0	E008,E011	Memory element error, CPU error	-	-
1	0	0	1	E010	Detector error	-	-
1	0	1	0	E012,E013, E035,E036	External error, USP error, thermistor error, break fault	-	-
1	0	1	1	E014	Ground fault protection	-	-
1	1	0	0	E040,E041, E042,E043, E044,E045	Operation panel communication error, RS485 communication error, RTC error, EzSQ executive instruction error, overflow error, illegal instruction error	-	-
1	1	0	1	E020,E021	Abnormal temperature error caused by reduced rotation speed of the cooling fan, abnormal temperature error	-	-
1	1	1	0	E024,E034	Input open-phase error, output open-phase error	-	-
1	1	1	1	Other than above	EzSQ assignment error 0 to 9, etc.	-	-

**12.19.4** Outputting a warning when an overload occurs



- I want to know an increase in the output current of the motor from a warning signal.
- I want to know an increase in the motor current at its early stage.



- Assign the output terminal functions 035 [OL] and 036 [OL2] overload prewarning signal to one of [CC-01] to [CC-07] that corresponds to the output terminal and output the signal.
- The overload prewarning signals [OL] and [OL2] will be output when the output currents exceed the corresponding overload prewarning level.
- You can output the signal in accordance with the operating state by changing the overload prewarning signal output mode selection [CE105].
- This function is effective, especially for conveyors, to prevent machine failure that may occur when the load increases because an excessive number of packages are loaded, or to prevent carrier lines from stopping because of an overload error of the inverter.

- When [CE105] = 00

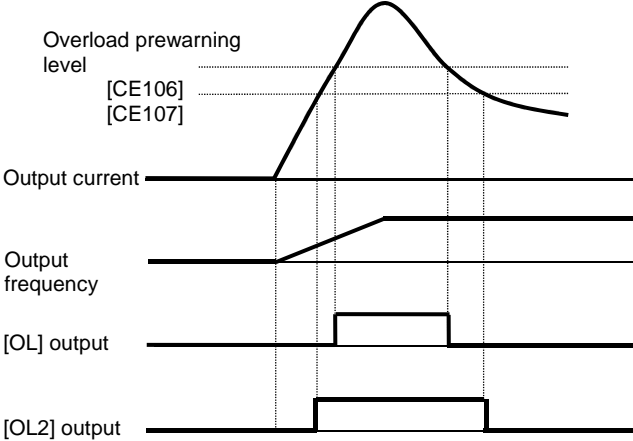

- An overcurrent error may occur before the signal is output when the overload prewarning level has been set to an excessively high value. In this case, reduce the overload prewarning level.
- Small fluctuations in the frequency input may hinder the speed from being determined as constant when an analog input is used as the frequency command. In this case, change the overload prewarning signal output mode selection [CE105] to 00 (valid in operation).

- When [CE105] = 01

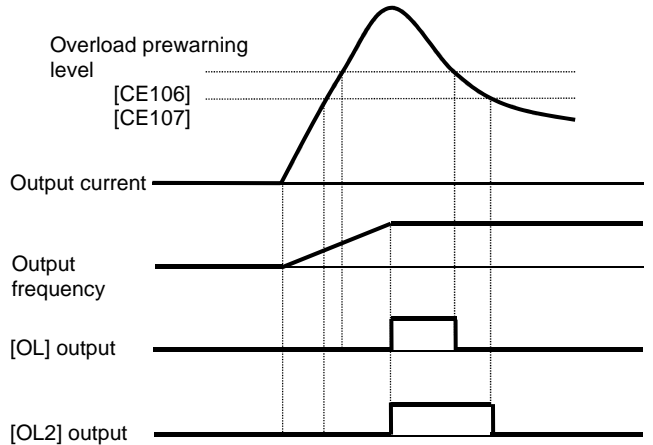

**Parameter**

Item	Parameter	Data	Description
Output terminal function selection 11-15	[CC-01]~[CC-05]	035 036	035 [OL]: Overload prewarning signal 1 is output. 036 [OL2]: Overload prewarning signal 2 is output. OFF: Less than or equal to the overload prewarning signal level ON: More than or equal to the overload prewarning signal level
Relay output terminal function selection 16A-16C	[CC-06]		
Relay output terminal function selection AL1-AL0/AL2-AL0	[CC-07]		
Overload prewarning signal output mode selection	[CE105]	00	Valid in operation
		01	Valid only in constant speed operation
Overload prewarning signal level 1	[CE106]	(0.00 to 2.00) x inverter rated current	Specify the current level at which the overload prewarning signal is output. The signal will be output when the current exceeds the overload prewarning signal level.
Overload prewarning signal level 2	[CE107]		

**12.19.5** Outputting a warning when the current is low



- I want to make a notification with a warning about a decrease in the output current of the motor.
- I want to detect a decrease in the motor current when the load dropout in the load occurs.



- Assign the output terminal functions 033 [LOC] and 034 [LOC2] low current signal to one of [CC-01] to [CC-07] that corresponds to the output terminal and output the signal.
- The low current detection signal can be output when the load has reduced.

• When [CE101] = 00

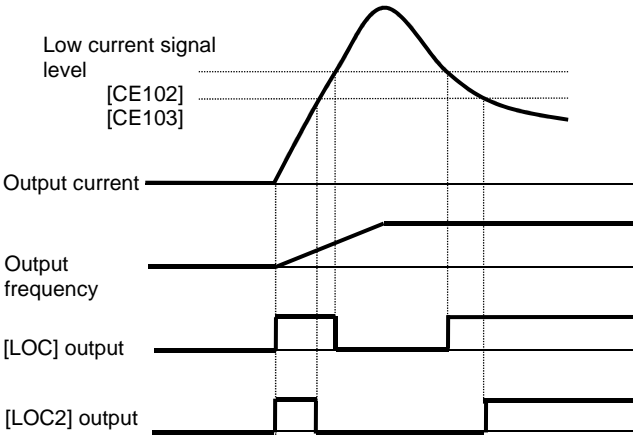

- Small fluctuations in the frequency input may hinder the speed from being determined as constant when an analog input is used as the frequency command. In this case, change the low current signal output mode selection [CE101] to 00 (valid in operation).

- The low current signals 033 [LOC] and 034 [LOC2] will be output when the output currents becomes lower than the low current detection levels [CE102] and [CE103], respectively.
- You can output the signal in accordance with the operating state by changing the low current signal output mode selection [CE101].

• When [CE101] = 01

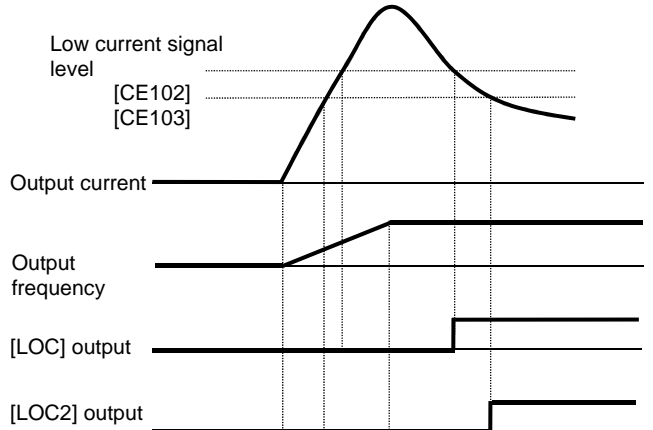

■ Parameter

Item	Parameter	Data	Description
Output terminal function selection 11-15	[CC-01]-[CC-05]		033 [LOC]: Low current signal 1 is output. 034 [LOC2]: Low current signal 2 is output. OFF: Less than or equal to the low current signal level ON: More than or equal to the low current signal level
Relay output terminal function selection 16A-16C	[CC-06]	033 034	
Relay output terminal function selection AL1-AL0/AL2-AL0	[CC-07]		
Low current signal output mode selection	[CE101]	00	Valid in operation
		01	Valid only in constant speed operation
Low current detection level 1	[CE102]	(0.00 to 2.00) x inverter rated current	Specify the current level at which the low current prewarning signal is output. The signal will be output when the current becomes lower than the low current prewarning detection level.
Low current detection level 2	[CE103]		

**12.19.6** Outputting a warning when a momentary interruption occurs



- I want to make a notification with a warning when a momentary interruption occurs.



- Assign the output terminal function 020 [IP] under momentary interruption signal to one of [CC-01] to [CC-07] that corresponds to the output terminal and output the signal.
- The momentary interruption signal can be output when a momentary interruption occurs in the inverter main power.
- An interruption in the main power can be output as a signal when the control power is supplied via a separate line.
- Example of a momentary interruption



- The momentary interruption signal [IP] is valid when the main power is input from R-S-T.
- The momentary interruption signal [IP] is output while the control power of the inverter remains (including when a 24-V power supply is used).
- To set errors that will be generated when a momentary interruption occurs, refer to 12.16.6 “Generating a momentary interruption/undervoltage trip.”
- To perform retry restart operation without generating errors when a momentary interruption occurs, refer to 12.13.7 “Restarting the inverter after recovering from a momentary interruption.”

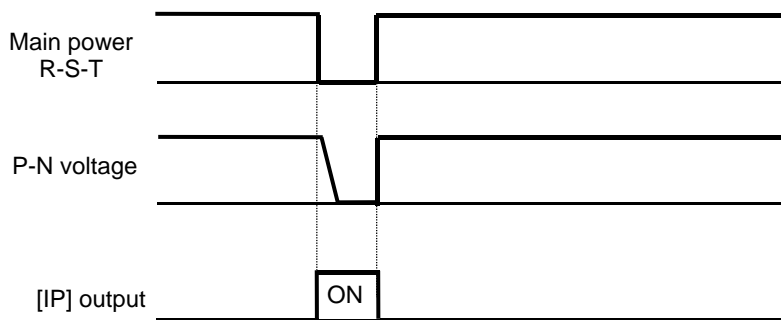

■ Parameter

Item	Parameter	Data	Description
Output terminal function selection 11-15	[CC-01]~[CC-05]	020	The momentary interruption signal [IP] is output. OFF: Input power to R-S-T has been established. ON: Input power to R-S-T was established and then interrupted.
Relay output terminal function selection 16A-16C	[CC-06]		
Relay output terminal function selection AL1-AL0/AL2-AL0	[CC-07]		

**12.19.7** Outputting a warning while an undervoltage occurs



- I want to generate a warning when an undervoltage occurs.



- Assign the output terminal function 021 [UV] undervoltage signal to one of [CC-01] to [CC-07] that corresponds to the output terminal and output the signal.
- The undervoltage signal can be output when a power failure occurs in the main power and control power.
- You can output the signal by assigning the undervoltage signal 021 [UV] to the output terminal selection.
- Example of an undervoltage (R0 and T0/24V are supplied from a separate power)



- The undervoltage signal [UV] is output while the control power of the inverter remains (including when a 24-V power supply is used).
- To set errors that will be generated when an undervoltage occurs, refer to 12.16.6 “Generating a momentary interruption/undervoltage trip.”
- To perform retry restart operation without generating errors when an undervoltage occurs, refer to 12.13.6 “Restarting the inverter after recovering from an undervoltage.”
- The [UV] signal is output under an undervoltage state irrespective of the occurrence of a trip.

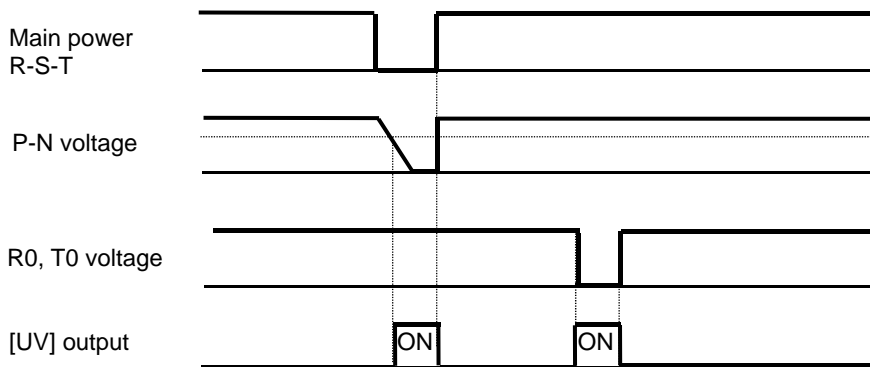

■ Parameter

Item	Parameter	Data	Description
Output terminal function selection 11-15	[CC-01]~[CC-05]	021	The undervoltage signal [UV] is output. OFF: Internal PN voltage and control power have been established. ON: Internal PN voltage or control power is insufficient.
Relay output terminal function selection 16A-16C	[CC-06]		
Relay output terminal function selection AL1-AL0/AL2-AL0	[CC-07]		

**12.19.8** Outputting a warning before thermal protection of the motor



- I want to check the motor current and output the signal before the motor electronic thermal calculated by the inverter generates an error.
- I want to cool the system before a thermal error is generated.



- The motor overload error [E005] will be generated when the motor thermal integrated value reaches 100.00%.
- For the settings of motor electronic thermal, refer to 12.7.1 “Setting the electronic thermal of the motor.”



- Assign the output terminal function 026 [THM] motor thermal warning signal to one of [CC-01] to [CC-07] that corresponds to the output terminal and output the signal.
- You can understand the state from the signal before the motor overload error [E005] is generated by the electronic thermal function.

■ Example operation (when thermal subtractions enabled)

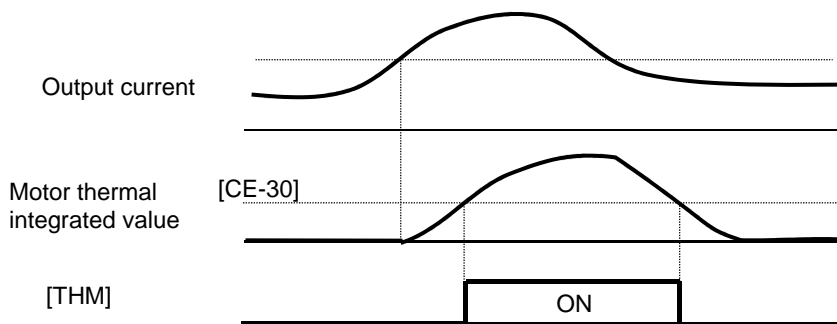

■ Parameter

Item	Parameter	Data	Description
Output terminal function selection 11-15	[CC-01]~[CC-05]	026	The thermal warning signal [THM] of the motor is output. OFF: The motor thermal integrated value is smaller than the level. ON: The motor thermal integrated value is equal to or larger than the level.
Relay output terminal function selection 16A-16C	[CC-06]		
Relay output terminal function selection AL1-AL0/AL2-AL0	[CC-07]		
Electronic thermal warning level (motor)	[CE-30]	0.00~100.00(%)	The signal [THM] is turned on when the thermal integrated value of the motor is equal to or larger than the set level. This function does not work when this level has been set to 0.00.

**12.19.9** Outputting a warning before thermal protection of the inverter



- I want to check the motor current and output the signal before the inverter electronic thermal calculated by the inverter generates an error.
- I want to cool the system before a thermal error is generated.



- Assign the output terminal function 027 [THC] controller (inverter) thermal warning signal to one of [CC-01] to [CC-07] that corresponds to the output terminal and output the signal.
- You can understand the state from the signal before the controller overload error [E039] is generated by the electronic thermal function.



- The controller overload error [E039] will be generated when the inverter thermal integrated value reaches 100.00%.
- For the protection of inverters, electronic thermal characteristics of inverters are fixed and specific to the type.
- Inverter thermal values are cleared every 10 minutes. However, integration is processed in a dual-redundant system, so that the value may not be cleared when the current is high and the integrated value increases.

■ Operation example

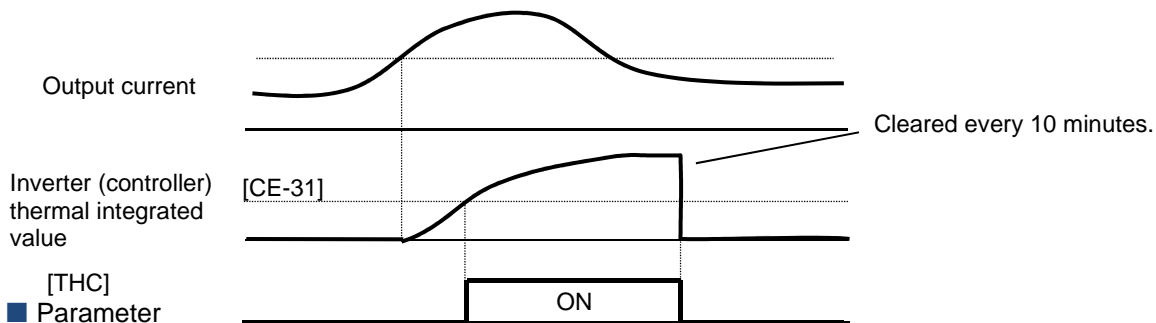

Item	Parameter	Data	Description
Output terminal function selection 11-15	[CC-01]~[CC-05]	027	The thermal warning signal [THC] of the inverter is output. OFF: The inverter thermal integrated value is smaller than the level. ON: The inverter thermal integrated value is equal to or larger than the level.
Relay output terminal function selection 16A-16C	[CC-06]		
Relay output terminal function selection AL1-AL0/AL2-AL0	[CC-07]		
Electronic thermal warning level (controller (Inverter))	[CE-31]	0.00~100.00(%)	The signal [THC] is turned on when the thermal integrated value of the inverter is equal to or larger than the set level.



### 12.19.10 Outputting a warning when the temperature of the cooling fin increases

Q

- I want to know a increase in the temperature of the cooling fin before a trip occurs.
- I want to cool the system before a thermal error is generated.



- The temperature error [E021] is generated when the cooling fin temperature exceeds 120°C.

A

- Assign the output terminal function 032 [OHF] cooling fin heating prewarning signal to one of [CC-01] to [CC-07] that corresponds to the output terminal and output the signal.
- You can understand the state from the signal before the temperature error [E021] is generated by the cooling fin heating prewarning level function.

#### ■ Operation example

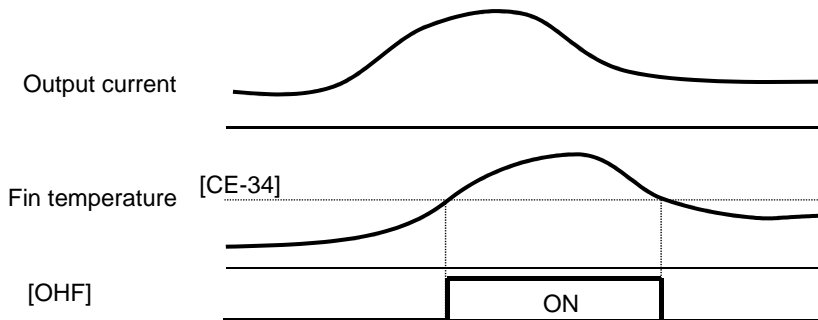

#### ■ Parameter

Item	Parameter	Data	Description
Output terminal function selection 11-15	[CC-01]~[CC-05]	032	The cooling fin heating prewarning signal[OHF]is output. OFF: Fin temperature is lower than the prewarning level. ON: Fin temperature is equal to or higher than the prewarning level.
Relay output terminal function selection 16A-16C	[CC-06]		
Relay output terminal function selection AL1-AL0/AL2-AL0	[CC-07]		
Cooling fin heating prewarning level	[CE-34]	0~200(°C)	The signal [OHF] is turned on when the cooling fin temperature is equal to or higher than the set level.

### 12.19.11 Outputting a warning about the lives of the capacitors on the control circuit board



- I want to know the lives of the capacitors on the circuit board before they reach their life spans.



- You are recommended to replace the main circuit board and the logic board when a warning about capacitor lives is generated.



- Assign the output terminal function 029 [WAC] capacitor life prewarning signal to one of [CC-01] to [CC-07] that corresponds to the output terminal and output the signal.
- The life spans of the capacitors on the circuit board are diagnosed from the temperature inside the inverter and the energized time.
- The state of this signal can be monitored by using the life diagnostic monitor. Refer to 13.11.1 “Checking the life monitor.”
- A warning will also be displayed in the display icons on the operating panel.

#### ■ Parameter

Item	Parameter	Data	Description
Output terminal function selection 11-15	[CC-01]~[CC-05]	029	The capacitor life prewarning signal (on board) [WAC] is output. OFF: No warning ON: Time to replace the circuit board because the capacitors has reached their life spans
Relay output terminal function selection 16A-16C	[CC-06]		
Relay output terminal function selection AL1-AL0/AL2-AL0	[CC-07]		
Life diagnostic monitor	[dC-16]	LL~HH	The monitors become H at the end of the life spans. The monitor on the right indicates the lives of the capacitors on the circuit board, whereas that on the left indicates the life of the cooling fan.

### 12.19.12 Outputting a warning about the life of the cooling fan



- I want to know the life of the cooling fan before it reaches its life span.



- Assign the output terminal function 030 [WAF] cooling fan rotation speed reduction signal to one of [CC-01] to [CC-07] that corresponds to the output terminal and output the signal.
- The signal is output when it is detected that the rotation speed of the cooling fan incorporated in the inverter has decreased to 75% or less.
- The state of this signal can be monitored by using the life diagnostic monitor. Refer to 13.11.1 "Checking the life monitor."
- A warning will also be displayed in the display icons on the operating panel.



- Check the cooling fan for clogging when this signal is output.
- This signal will not be output when the fan is stopped by selecting the cooling fan operation.

#### ■ Parameter

Item	Parameter	Data	Description
Output terminal function selection 11-15	[CC-01]~[CC-05]	030	The cooling fan rotation speed reduction signal [WAF] is output. OFF: No warning ON: Fan rotation speed has decreased
Relay output terminal function selection 16A-16C	[CC-06]		
Relay output terminal function selection AL1-AL0/AL2-AL0	[CC-07]		
Life diagnostic monitor	[dC-16]	LL~HH	The monitors become H at the end of the life spans. The monitor on the right indicates the lives of the capacitors on the circuit board, whereas that on the left indicates the life of the cooling fan.

### 12.19.13 Outputting a warning based on the number of operating hours



- I want to know when the number of operating hours reaches a certain period of time.
- I want to output with a signal the number of operating hours of the system in which the inverter has been incorporated.



- Assign the output terminal function 024 [RNT] RUN time over signal to one of [CC-01] to [CC-07] that corresponds to the output terminal and output the signal.
- Specify the RUN time/power-on time level [CE-36].
- The RUN time over signal [RNT] will be output when the cumulative total of inverter operating hours exceeds the time specified with the RUN time/power-on time level [CE-36].



- When specifying the time level as a guideline for replacement, use a number with an adequate margin.

- Setting example

First time:

When you want to generate a warning after an operation of (250 days × 8 hours × 5 years =) 10,000 hours, set [CE-36] to 10,000.

Second time onward:

When you want to generate a warning after an operation of (250 days × 8 hours × 5 years =) 10,000 hours, set [CE-36] to [dC-22] + 10,000.

#### Parameter

Item	Parameter	Data	Description
Output terminal function selection 11-15	[CC-01]~[CC-05]	024	The RUN time over signal [RNT] is output. OFF: Less than or equal to the RUN time level ON: More than the RUN time level
Relay output terminal function selection 16A-16C	[CC-06]		
Relay output terminal function selection AL1-AL0/AL2-AL0	[CC-07]		
RUN time/power-on time level	[CE-36]	0~100000[hour]	This function does not work when this level has been set to 0. Specify 1 to 100,000 hours.
Cumulative operating hours monitor during RUN	[dC-22]	0~65535[hour]	The number of hours when the inverter outputs is stored for monitoring.

### 12.19.14 Outputting a warning based on the amount of power-on hours

**Q**

- I want to know when the number of power-on hours reaches a certain period of time.
- I want to output with a signal the number of operating hours of the system in which the inverter has been incorporated.



- When specifying the time level as a guideline for replacement, use a number with an adequate margin.

**A**

- Assign the output terminal function 025 [ONT] power-on time over signal to one of [CC-01] to [CC-07] that corresponds to the output terminal and output the signal.
  - Assign 025 (ONT) to the output terminal.
  - Specify the power-on time level [CE-36].
  - The power-on time over signal [ONT] will be output when the cumulative total of inverter operating hours exceeds the time specified with the RUN time/power-on time level [CE-36].
- Setting example  
When you want to generate a warning after the inverter has been turned on for (300 days × 24 hours × 3 years =) 21,600 hours, set [CE-36] to 21,600.  
Second time onward:  
When you want to generate a warning after an operation of (250 days × 8 hours × 5 years =) 10,000 hours, set [CE-36] to [dC-24] + 10,000.

#### ■ Parameter

Item	Parameter	Data	Description
Output terminal function selection 11-15	[CC-01]~[CC-05]	025	The power-on time over [ONT] is output. OFF: Less than or equal to the power-on time level ON: More than the power-on time level
Relay output terminal function selection 16A-16C	[CC-06]		
Relay output terminal function selection AL1-AL0/AL2-AL0	[CC-07]		
RUN time/power-on time level	[CE-36]	0~100000[hour]	This function does not work when this level has been set to 0. Specify 1 to 100,000 hours.
Cumulative power-on time monitor	[dC-24]	0~65535[hour]	The number of hours when the inverter has been turned on is stored for monitoring.

### 12.19.15 Outputting a warning when the incoming voltage is high



- I want to generate a warning when the power supply voltage is high.



- This function performs detection only when the inverter is stopped. This function does not work while the inverter is in operation.



- Assign the output terminal function 081 [OVS] incoming overvoltage signal to one of [CC-01] to [CC-17] that corresponds to the output terminal and output the signal.
- The incoming overvoltage signal [OVS] turns on when the PN voltage of the main circuit exceeds the voltage level specified with the incoming overvoltage level selection [bb-62] for 100 s continuously.
- When incoming overvoltage level [bb-61] is set to 00, the signal [OVS] will be output.
- When incoming overvoltage level [bb-61] is set to 01, the signal [OVS] will be output, while a trip being made due to incoming overvoltage error [E015].

#### ■ Parameter

Item	Parameter	Data	Description
Output terminal function selection 11-15	[CC-01]~[CC-05]	081	The signal [OVS] is output when the incoming voltage is high. OFF: Less than or equal to the incoming overvoltage level ON: More than the incoming overvoltage level
Relay output terminal function selection 16A-16C	[CC-06]		
Relay output terminal function selection AL1-AL0/AL2-AL0	[CC-07]		
Incoming overvoltage selection	[bb-61]	00	The signal [OVS] will be output.
		01	•The signal [OVS] will be output, while a trip being made due to incoming overvoltage error [E015].
Incoming overvoltage level selection	[bb-62]	(200-V class) 300.0Vdc~400.0Vdc (400-V class) 600.0Vdc~800.0Vdc	The number of hours when the inverter has been turned on is stored for monitoring.



## 12.20 How to output the operating status to a terminal

### 12.20.1 Outputting a signal during operation (output)



- I want to detect the output status of the inverter and convey to the system.



- Assign the output terminal function 001 [RUN] running signal to one of [CC-01] to [CC-07] that corresponds to the output terminal and output the signal.

- The timing chart is as follows.

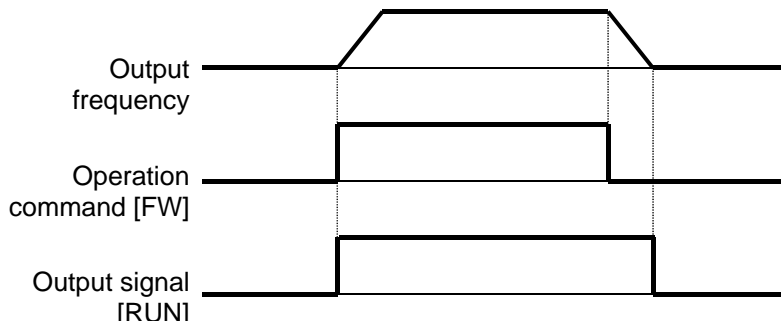

- The signal becomes ON not only when the motor is operating at normal rotation but also when a voltage is output to the motor as a function such as DC braking.
- The signal [RUN] will not be output when the inverter is waiting for a retry or DC braking.

#### Parameter

Item	Parameter	Data	Description
Output terminal function selection 11-15	[CC-01]~[CC-05]	001	The signal [RUN] is output to the output terminal assigned.
Relay output terminal function selection 16A-16C	[CC-06]		
Relay output terminal function selection AL1-AL0/AL2-AL0	[CC-07]		



**1220.2** Outputting a signal during forward- or reverse-direction operation



- I want to detect the information of inverter operating the forward direction and convey to the system.
- I want to detect the information of inverter operating the reverse-direction and convey to the system.



- Assign the output terminal function 008 [FWR] forward-direction operating signal to one of [CC-01] to [CC-07] that corresponds to the output terminal and output the signal.
- You can output the signal only when the inverter is operating in the forward direction by assigning 008 [FWR] to the output terminal function selection.
- The timing chart is as follows.

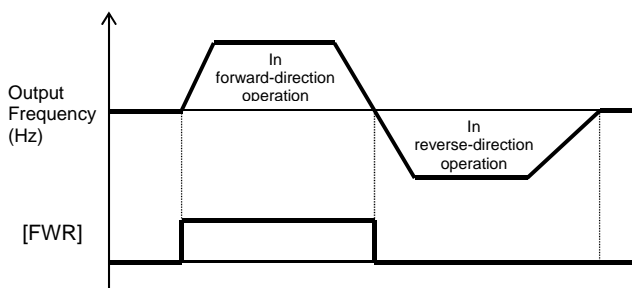

- [FWR] and [RVR] will not be output during DC breaking or when the servo is on.

- Assign the output terminal function 009 [RVR] reverse-direction operating signal to one of [CC-01] to [CC-07] that corresponds to the output terminal and output the signal.
- You can output the signal only when the inverter is operating in the reverse direction by assigning 009 [RVR] to the output terminal function selection.
- The timing chart is as follows.

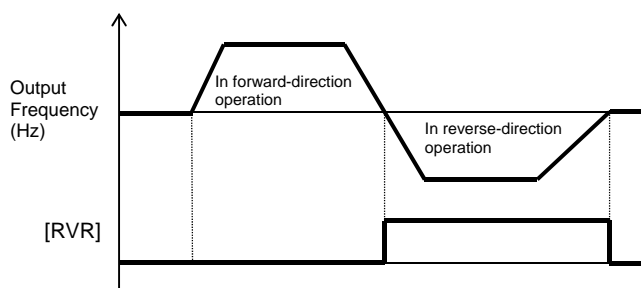

■ Parameter

Item	Parameter	Data	Description
Output terminal function selection 11-15	[CC-01]~[CC-05]	008	[FWR]: The forward-direction operation signal is output to the output terminal assigned.
Relay output terminal function selection 16A-16C	[CC-06]		
Relay output terminal function selection AL1-AL0/AL2-AL0	[CC-07]	009	[RVR]: The reverse-direction operation signal is output to the output terminal assigned.

### 1220.3 Outputting a signal when an operation command exists

Q

- I want to detect the information that an operation command has been input to the inverter and convey to the system.

A

- Assign the output terminal function 031 [FR] start-up contact signal to one of [CC-01] to [CC-07] that corresponds to the output terminal and output the signal.
- The start-up contact signal 031 [FR] is output while the inverter accepts operation commands.
- The start-up contact signal [FR] is output in accordance with the state how the operation command is accepted even when the destination of the operation command is not a contact.

- The timing chart is as follows.  
(Example) In the case of a terminal command

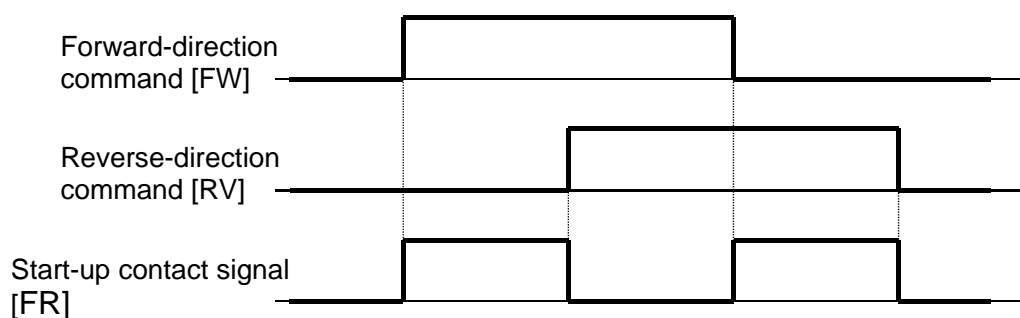

- When the inverter is operated by using terminal commands, simultaneous inputs of the forward-direction command [FW] and the reverse-direction command [RV] will cause a command mismatch, which is interpreted as the stop command. •In this case, the [FR] signal will not be output.
- The signal becomes ON not only when the motor is operating at normal rotation but also when a voltage is output to the motor as a function such as DC breaking.
- When the operation enable signal 101 [REN] has been assigned and set to OFF, the signal [FR] becomes OFF because the inverter cannot be operated.

#### Parameter

Item	Parameter	Data	Description
Output terminal function selection 11-15	[CC-01]~[CC-05]	031	[FR]: The start-up contact signal is output to the output terminal assigned.
Relay output terminal function selection 16A-16C	[CC-06]		
Relay output terminal function selection AL1-AL0/AL2-AL0	[CC-07]		

### 12.20.4 Outputting a signal when the preparations for operation have been completed



- I want to convey to the system when the inverter is ready for accepting operation commands.



- Assign the output terminal function 007 [IRDY] operation preparation completed signal to one of [CC-01] to [CC-07] that corresponds to the output terminal and output the signal.
- The operation preparation completed signal 007 [IRDY] is output when the inverter can accept operation commands.
- The timing chart is as follows.  
(Example) In the case of a terminal command

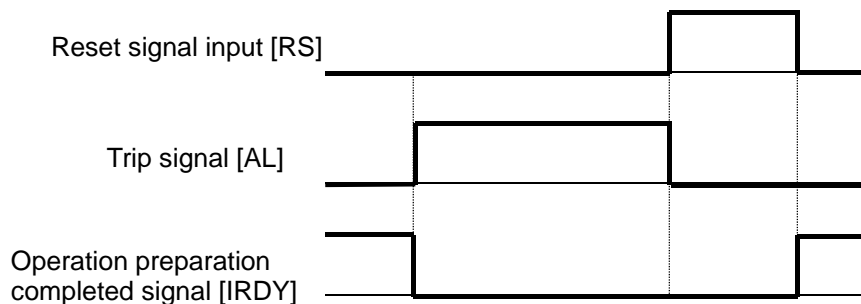

- When this signal is not output, the inverter cannot be operated even if operation commands are input.
- This signal becomes OFF when output operation is disabled, such as during start-up preparation at power-up, when under-voltage of the R-S-T input voltage occurs, while the inverter has been tripped, and under a free run stop command.

#### ■ Parameter

Item	Parameter	Data	Description
Output terminal function selection 11-15	[CC-01]~[CC-05]	007	[IRDY]: The operation preparation completed signal is output to the output terminal assigned.
Relay output terminal function selection 16A-16C	[CC-06]		
Relay output terminal function selection AL1-AL0/AL2-AL0	[CC-07]		

## 12.21 How to compare the output frequency and output to the terminal

### 12.21.1 Outputting a signal when the frequency reaches the target



- I want to detect that the output frequency to the motor has increased to the command and make a notification to the system.



- Assign the output terminal function 002 [FA1] constant-speed reaching output signal to one of [CC-01] to [CC-07] that corresponds to the output terminal and output the signal.
- The signal will be output when the frequency has reached the enabled frequency command.



- The signal [FA1] may not be output stably when the frequency command fluctuates because an analog input command is used. In this case, the symptom may be alleviated by using the ON/OFF delay function of the output terminal.

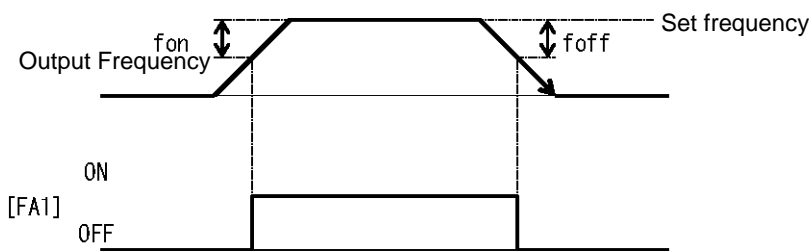

$f_{on}$ : 1% of the maximum frequency  
 $f_{off}$ : 2% of the maximum frequency

- (Operation example)  
 Maximum frequency: 60 Hz  
 Set frequency: 50 Hz
- $f_{on}=60 \times 0.01=0.6\text{Hz}$
  - $f_{off}=60 \times 0.02=1.2\text{Hz}$
  - In acceleration: On at  $50 - 0.6 = 49.4\text{ Hz}$
  - In deceleration: On at  $50 - 1.2 = 48.8\text{ Hz}$

#### Parameter

Item	Parameter	Data	Description
Output terminal function selection	[CC-01]~[CC-05]	002	[FA1]:The constant-speed reaching output will be output as a signal to the output terminal assigned.
Relay output terminal function selection	[CC-06]		
Relay output terminal function selection	[CC-07]		

**12.21.2** Outputting a signal when the frequency reaches the target



- I want to detect that the output frequency to the motor has become a frequency larger than the set value and make a notification to the system.



- The operation of [FA2] can be set through [CE-10] and [CE-11].
- The operation of [FA4] can be set through [CE-12] and [CE-13].



- Assign the output terminal functions 003 [FA2] and 005 [FA4] exceeding set frequency signal to one of [CC-01] to [CC-07] that corresponds to the output terminal and output the signals.
- The signals [FA2] and [FA4] can be output to output terminal functions individually as the exceeding set frequency output signal.
- The signals [FA2] and [FA4] will be output when the enabled output frequency exceeds the setting.

• Operation example

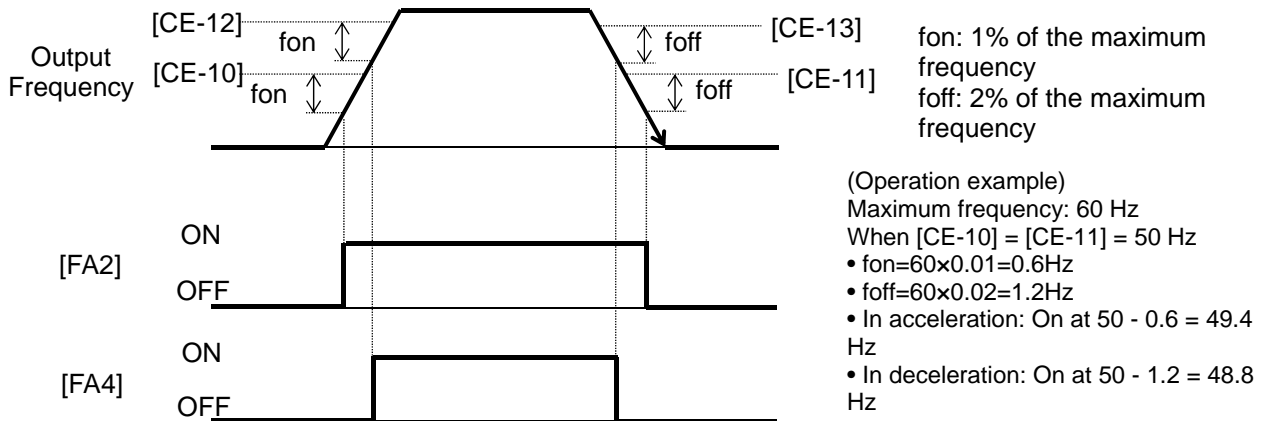

■ Parameter

Item	Parameter	Data	Description
Output terminal function selection	[CC-01]~[CC-05]		003 [FA2]: The exceeding set frequency signal will be output to the output terminal assigned. 005 [FA4]: The exceeding set frequency signal 2 will be output to the output terminal assigned.
Relay output terminal function selection	[CC-06]	003	
Relay output terminal function selection	[CC-07]	005	
Acceleration reaching frequency 1	[CE-10]	0.00~590.00(Hz)	The frequency to judge that the frequency has been reached in acceleration and output the signal [FA2].
Deceleration reaching frequency 1	[CE-11]	0.00~590.00(Hz)	The frequency to judge that the frequency has been reached in deceleration and output the signal [FA2].
Acceleration reaching frequency 2	[CE-12]	0.00~590.00(Hz)	The frequency to judge that the frequency has been reached in acceleration and output the signal [FA4].
Deceleration reaching frequency 2	[CE-13]	0.00~590.00(Hz)	The frequency to judge that the frequency has been reached in deceleration and output the signal [FA4].

**12.21.3** Outputting a signal when the frequency reaches the set value



- I want to detect that the output frequency to the motor has reached around the set value and make a notification to the system.



- The operation of [FA3] can be set through [CE-10] and [CE-11].
- The operation of [FA5] can be set through [CE-12] and [CE-13].



- Assign the output terminal functions 004 [FA3] and 006 [FA5] set frequency only output signals to one of [CC-01] to [CC-07] that corresponds to the output terminal and output the signals.
- The signals [FA3] and [FA5] can be output individually.
- The signals [FA3] and [FA5] will be output when the enabled output frequency reaches around the setting value.

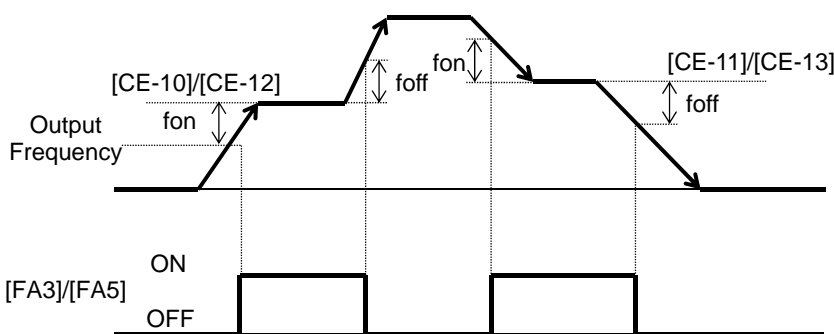

fon: 1% of the maximum frequency  
foff: 2% of the maximum frequency

- (Operation example)  
Maximum frequency: 60 Hz  
When [CE-10] = [CE-11] = 50 Hz
- $fon=60 \times 0.01=0.6\text{Hz}$
  - $foff=60 \times 0.02=1.2\text{Hz}$
  - In acceleration: On at  $50 - 0.6 = 49.4\text{ Hz}$   
Off at  $50 + 1.2 = 51.2\text{ Hz}$
  - In deceleration: On at  $50 + 0.6 = 50.6\text{ Hz}$   
Off at  $50 - 1.2 = 48.8\text{ Hz}$

■ Parameter

Item	Parameter	Data	Description
Output terminal function selection	[CC-01]~[CC-05]	004 006	[FA3]: The set frequency only reaching signal will be output to the output terminal assigned. [FA5]: The set frequency only reaching signal 2 will be output to the output terminal assigned.
Relay output terminal function selection	[CC-06]		
Relay output terminal function selection	[CC-07]		
Acceleration reaching frequency 1	[CE-10]	0.00~590.00(Hz)	The frequency to judge that the frequency has been reached in acceleration and output the signal [FA3].
Deceleration reaching frequency 1	[CE-11]	0.00~590.00(Hz)	The frequency to judge that the frequency has been reached in deceleration and output the signal [FA3].
Acceleration reaching frequency 2	[CE-12]	0.00~590.00(Hz)	The frequency to judge that the frequency has been reached in acceleration and output the signal [FA5].
Deceleration reaching frequency 2	[CE-13]	0.00~590.00(Hz)	The frequency to judge that the frequency has been reached in deceleration and output the signal [FA5].

**12.21.4** Outputting a signal when the frequency reaches around 0 Hz



- I want to detect that the output frequency to the motor has reached around 0 Hz and make a notification to the system.



- While the operation is stopped, the [ZS] signal becomes ON state because the frequency is 0 Hz.



- Assign the output terminal function 040 [ZS] 0-Hz detection signal to one of [CC-01] to [CC-07] that corresponds to the output terminal and output the signal.
- This function is to output a signal when the output frequency of the inverter becomes lower than the level specified with the 0-Hz detection value level [CE-33].
- When the feedback circuit board is used, the actual frequency of the motor is evaluated for outputting the signal.

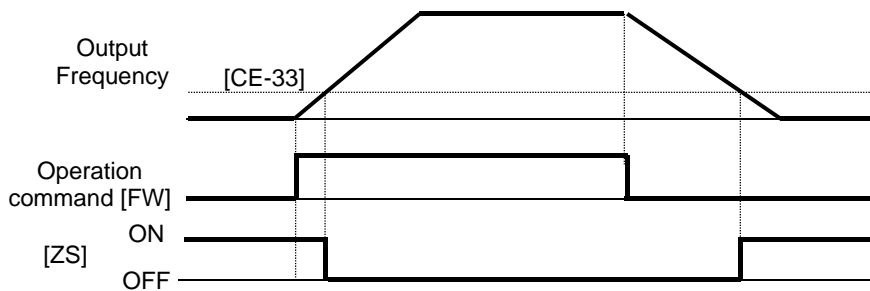

■ Parameter

Item	Parameter	Data	Description
Output terminal function selection	[CC-01]~[CC-05]	040	[ZS]: The 0-Hz signal is output to the output terminal assigned.
Relay output terminal function selection	[CC-06]		
Relay output terminal function selection	[CC-07]		
0-Hz detection value level	[CE-33]	0.00~100.00(Hz)	The frequency setting value to estimate 0-Hz state when [ZS] is output.

## 12.22 How to detect break and out-of-range errors at analog inputs

### 12.22.1 Detecting break and out-of-range errors at main body terminals



- I want to detect break errors at analog inputs.
- I want to maintain a constant speed even when a break or short-circuit error occurs.



- Assign the output terminal functions 050 [Ai1Dc], 051 [Ai2Dc], and 052 [Ai3Dc] analog break signals to one of [CC-01] to [CC-17] that corresponds to the output terminal and output the signals.
- The signals will be output when the input values of the analog inputs [Ai1], [Ai2], and [Ai3] are within the range from the lower limit level to the upper limit level of the window comparators. The analog inputs can be monitored at any value, so that this function can be used for detecting breaks, for example.



- When the signal [WCAi1], [WCAi2], or [WCAi3] is output, the value adopted to the analog input can be fixed to any value. Specify the value using the break operation level [Ai1], [Ai2], or [Ai3].
- When the analog hold function [AHD] is enabled, the input being held has higher priority.

- A hysteresis width can be specified to the upper and lower limit levels of the window comparator.
- A level and a hysteresis width can be specified to each of the analog inputs [Ai1], [Ai2], and [Ai3] individually.

#### Parameter

Item	Parameter	Data	Description
Output terminal function selection 11-15	[CC-01]~[CC-05]	050 051 052	The signals 050 [Ai1Dc], 051 [Ai2Dc], and 052 [Ai3Dc] will be output to the output terminal assigned.
Relay output terminal function selection 16A-16C	[CC-06]		
Relay output terminal function selection AL1-AL0/AL2-AL0	[CC-07]		
Output terminal function selection 11-15	[CC-01]~[CC-05]	056 057 058	The signals 056 [WCAi1], 057 [WCAi2], and 058 [WCAi3] will be output to the output terminal assigned.
Relay output terminal function selection 16A-16C	[CC-06]		
Relay output terminal function selection AL1-AL0/AL2-AL0	[CC-07]		
Window comparator Ai1/Ai2/Ai3 upper limit level	Ai1:[CE-40]	0~100(%)	Specify the upper limits of the analog inputs. The setting ranges are limited to the lower limits or greater.
	Ai2:[CE-43]	-100~100(%)	
	Ai3:[CE-46]		
Window comparator Ai1/Ai2/Ai3 lower limit level	Ai1:[CE-41]	0~100(%)	Specify the lower limits of the analog inputs. The setting ranges are limited to the upper limits or smaller.
	Ai2:[CE-44]	-100~100(%)	
	Ai3:[CE-47]		
Window comparator Ai1/Ai2/Ai3 hysteresis width	Ai1:[CE-42] Ai2:[CE-45] Ai3:[CE-48]	0~10(%)	The maxim hysteresis widths are limited to (upper limit level - lower limit level)/2.
Ai1/Ai2/Ai3 abnormal condition analog operation level	Ai1:[CE-50] Ai2:[CE-52]	0~100(%)	Specify the input values when the input become within the ranges according to their operation level selection.
	Ai3:[CE-54]	-100~100(%)	
Ai1/Ai2/Ai3 abnormal condition analog operation level selection	Ai1:[CE-51] Ai2:[CE-53] Ai3:[CE-55]	00	Disabled
		01	When the enabled WC signal is in operation (within the range)
		02	When the enabled WC signal is out of operation (beyond the range)



■ Window comparator operation

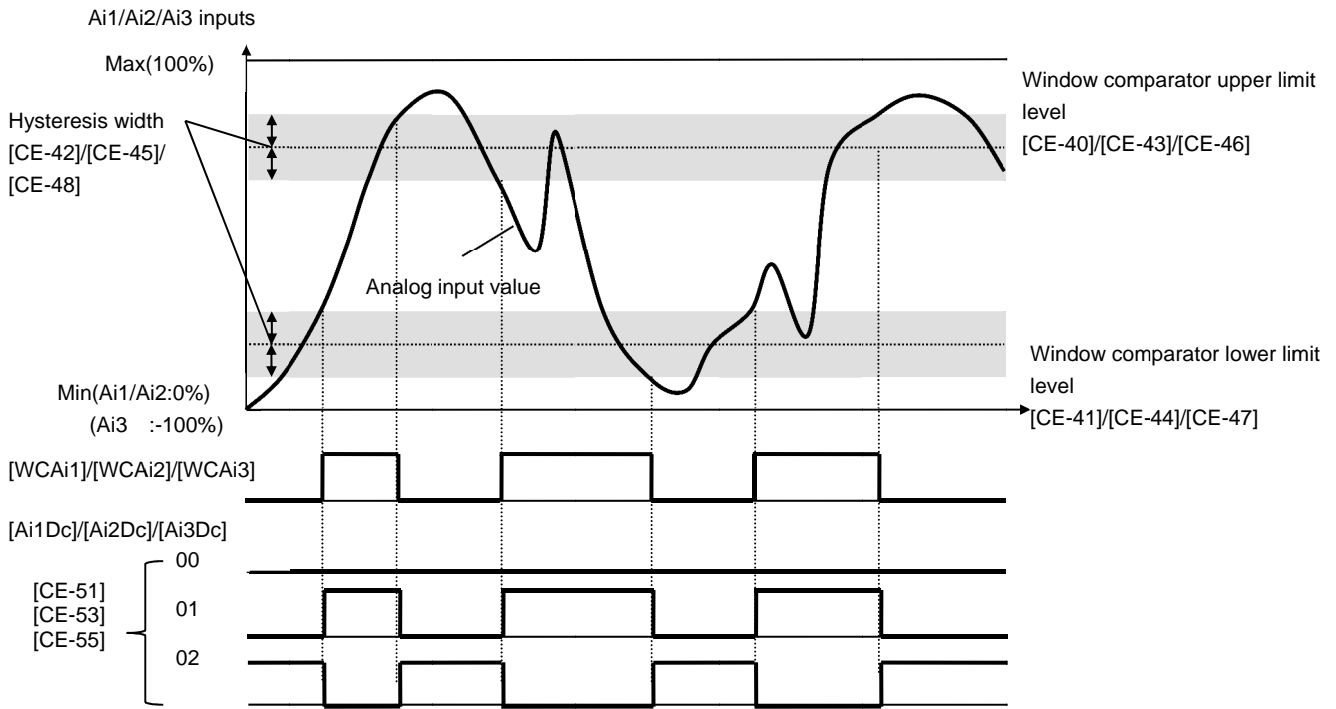

**A**

- In the window comparator function, the signal will be output when the input level is within the specified range.
- In the break detection function, the signal will be output when the input level is out of the specified range.
- The logical values of the output signals can be modified through [CC-11] to [CC-17].
- Specify the analog operation level to maintain the output level when the analog input becomes the maximum value because of a short circuit or when the analog input becomes 0 V because of a break.
- To prevent the signal from being output at power-on, specify the on delay times [CC-20], [CC-22], [CC-24], [CC-26], [CC-28], [CC-30], and [CC-32] of the output terminals.

■ Output operation in abnormal conditions

Example when [CE-51]/[CE-53]/[CE-55] = 02

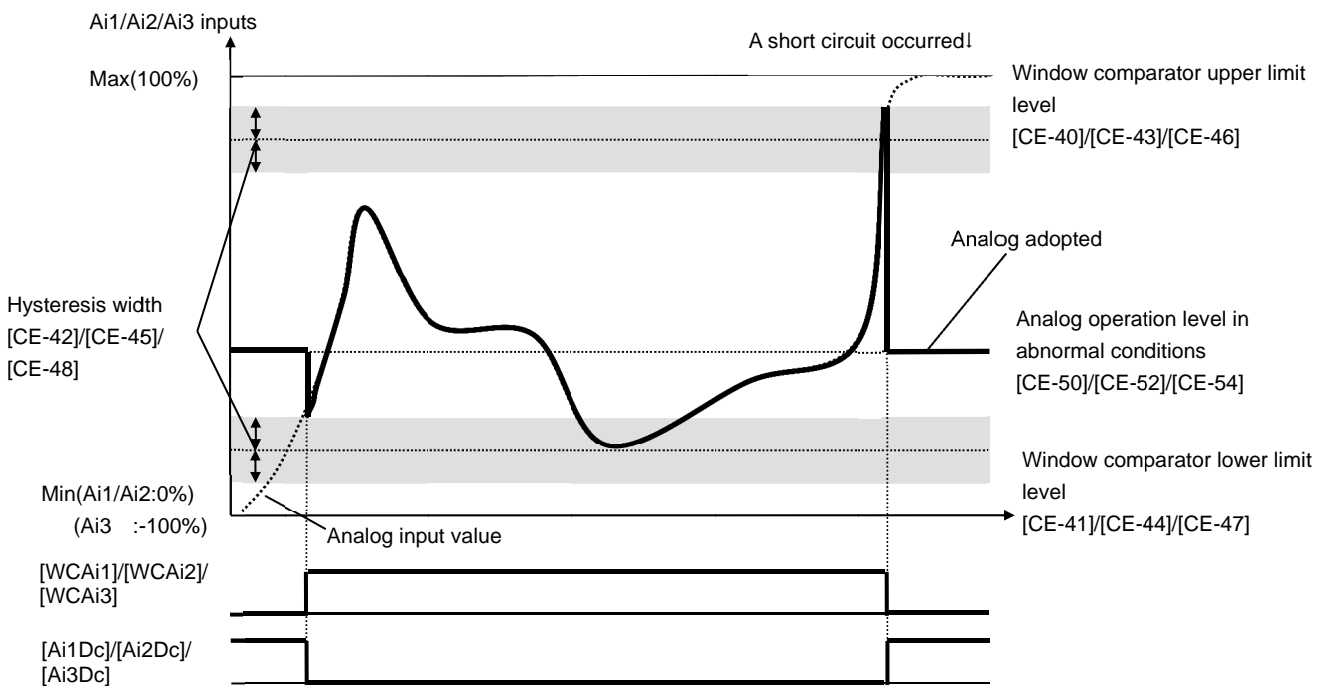

- Output operation in abnormal conditions  
 Example when [CE-51]/[CE-53]/[CE-55] = 01
- When the analog input becomes the minimum value (Min) because of a break in the input wire

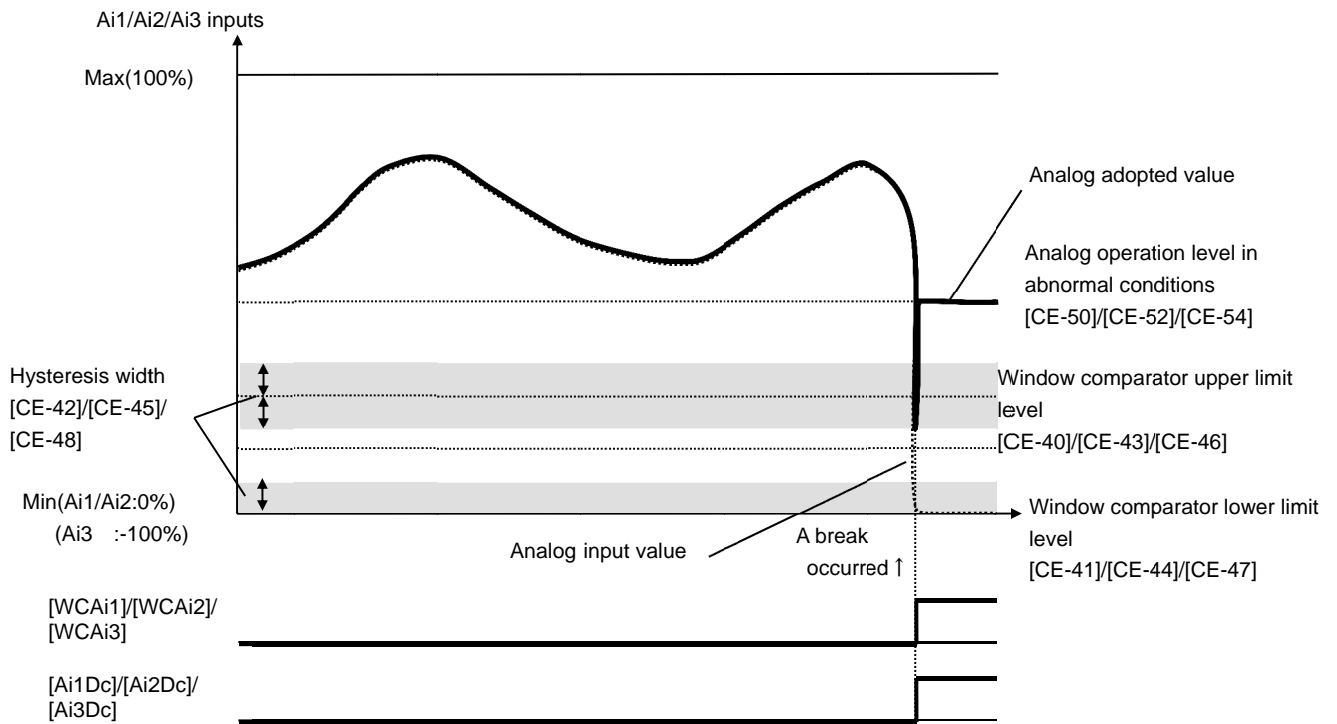

- When the analog input becomes the maximum value (Max) because of a short circuit in the input wire

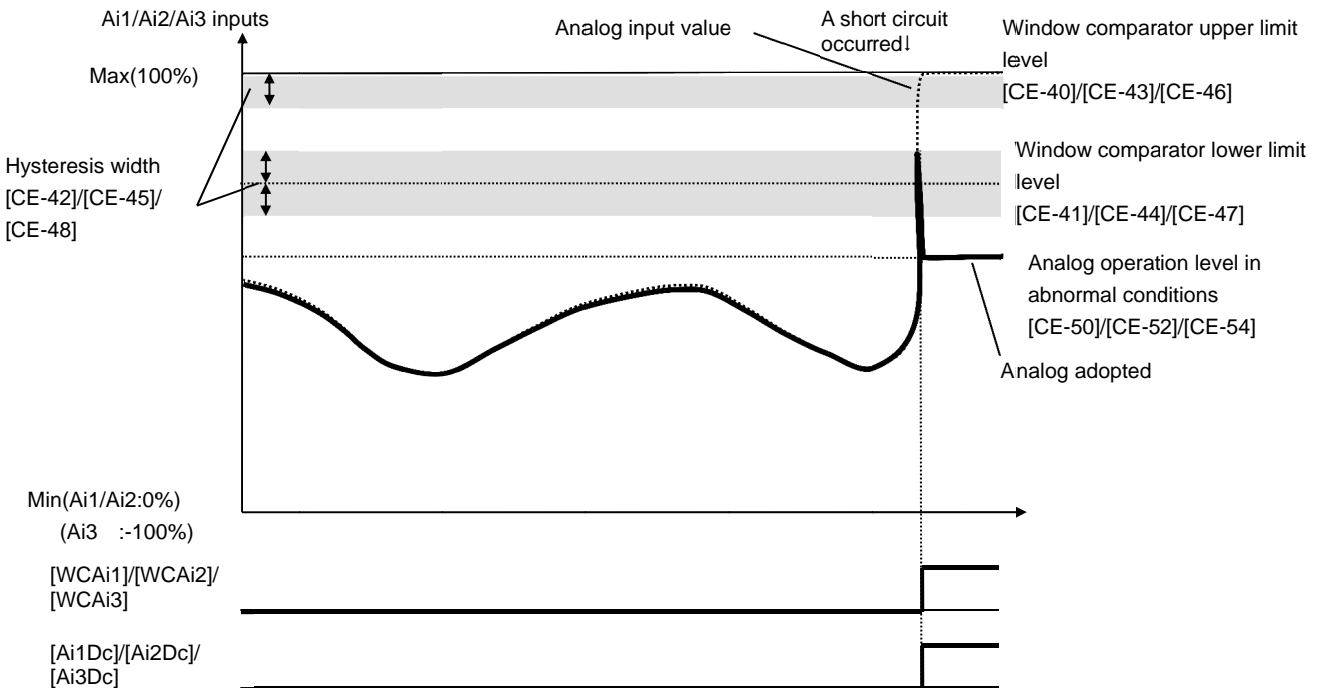

### 12.22.2 Detecting break and out-of-range errors at expansion option terminals



- I want to detect break errors at analog inputs when an expansion option is used.
- I want to maintain a constant speed even when a break or short-circuit error occurs.



- Assign the output terminal functions 053 [Ai4Dc], 054 [Ai5Dc], and 055 [Ai6Dc] analog break signals to one of [CC-01] to [CC-17] that corresponds to the output terminal and output the signals.
- The signals will be output when the input values of the analog inputs [Ai4] (Vi4,li4), [Ai5] (Vi5,li5), and [Ai6] (Vi6,li6) are within the range from the lower limit level to the upper limit level of the window comparators. The analog inputs can be monitored at any value, so that this function can be used for detecting breaks, for example.



- When the signal [WCAi4], [WCAi5], or [WCAi6] is output, the value adopted to the analog input can be fixed to any value. Specify the value using the break operation level [Ai4], [Ai5], or [Ai6].
- When the analog hold function [AHD] is enabled, the input being held has higher priority.

- A hysteresis width can be specified to the upper and lower limit levels of the window comparator.
- A level and a hysteresis width can be specified to each of the analog inputs [Ai4] (Vi4,li4), [Ai5] (Vi5,li5), and [Ai6] (Vi6,li6) individually.
- For details, refer to the instruction manual provided together with the optional device.

#### Parameter

Item	Parameter	Data	Description
Output terminal function selection 11-15	[CC-01]~[CC-05]	053 054 055	The signals 053 [Ai4Dc], 054 [Ai5Dc], and 055 [Ai6Dc] will be output to the output terminal assigned.
Relay output terminal function selection 16A-16C	[CC-06]		
Relay output terminal function selection AL1-AL0/AL2-AL0	[CC-07]		
Output terminal function selection 11-15	[CC-01]~[CC-05]	059 060 061	The signals 059 [WCAi4], 060 [WCAi5], and 061 [WCAi6] will be output to the output terminal assigned.
Relay output terminal function selection 16A-16C	[CC-06]		
Relay output terminal function selection AL1-AL0/AL2-AL0	[CC-07]		
Window comparator Ai4/Ai5/Ai6 upper limit level	Ai4:[oE-35]	0~100(%)	Specify the upper limits of the analog inputs. The setting ranges are limited to the lower limits or greater.
	Ai5:[oE-38]	-100~100(%)	
	Ai6:[oE-41]		
Window comparator Ai4/Ai5/Ai6 lower limit level	Ai4:[oE-36]	0~100(%)	Specify the lower limits of the analog inputs. The setting ranges are limited to the upper limits or smaller.
	Ai5:[oE-39]	-100~100(%)	
	Ai6:[oE-42]		
Window comparator Ai4/Ai5/Ai6 hysteresis width	Ai4:[oE-37] Ai5:[oE-40] Ai6:[oE-43]	0~10(%)	The maxim hysteresis widths are limited to (upper limit level - lower limit level)/2.
Ai4/Ai5/Ai6 abnormal condition analog operation level	Ai4:[oE-44] Ai5:[oE-46]	0~100(%)	Specify the input values when the input become within the ranges according to their operation level selection.
	Ai6:[oE-48]	-100~100(%)	
Ai4/Ai5/Ai6 abnormal condition analog operation level selection	Ai4:[oE-45] Ai5:[oE-47] Ai6:[oE-49]	00	Disabled
		01	When the enabled WC signal is in operation (within the range)
		02	When the enabled WC signal is out of operation (beyond the range)

■ Window comparator operation

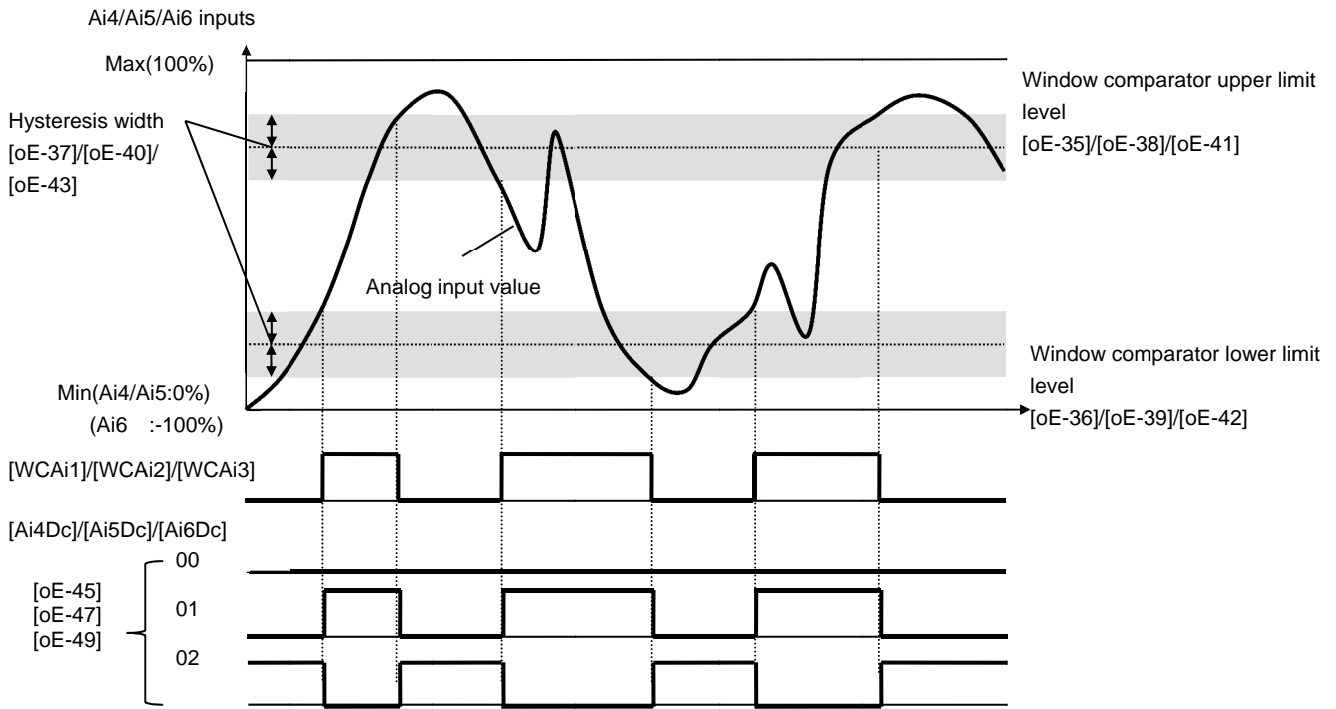

**A**

- In the window comparator function, the signal will be output when the input level is within the specified range.
- In the break detection function, the signal will be output when the input level is out of the specified range.
- The logical values of the output signals can be modified through  $[CC-11]$  to  $[CC-17]$ .
- Specify the analog operation level to maintain the output level when the analog input becomes the maximum value because of a short circuit or when the analog input becomes 0 V because of a break.
- To prevent the signal from being output at power-on, specify the on delay times  $[CC-20]$ ,  $[CC-22]$ ,  $[CC-24]$ ,  $[CC-26]$ ,  $[CC-28]$ ,  $[CC-30]$ , and  $[CC-32]$  of the output terminals.

■ Output operation in abnormal conditions

Example when  $[oE-45]/[oE-47]/[oE-49] = 02$

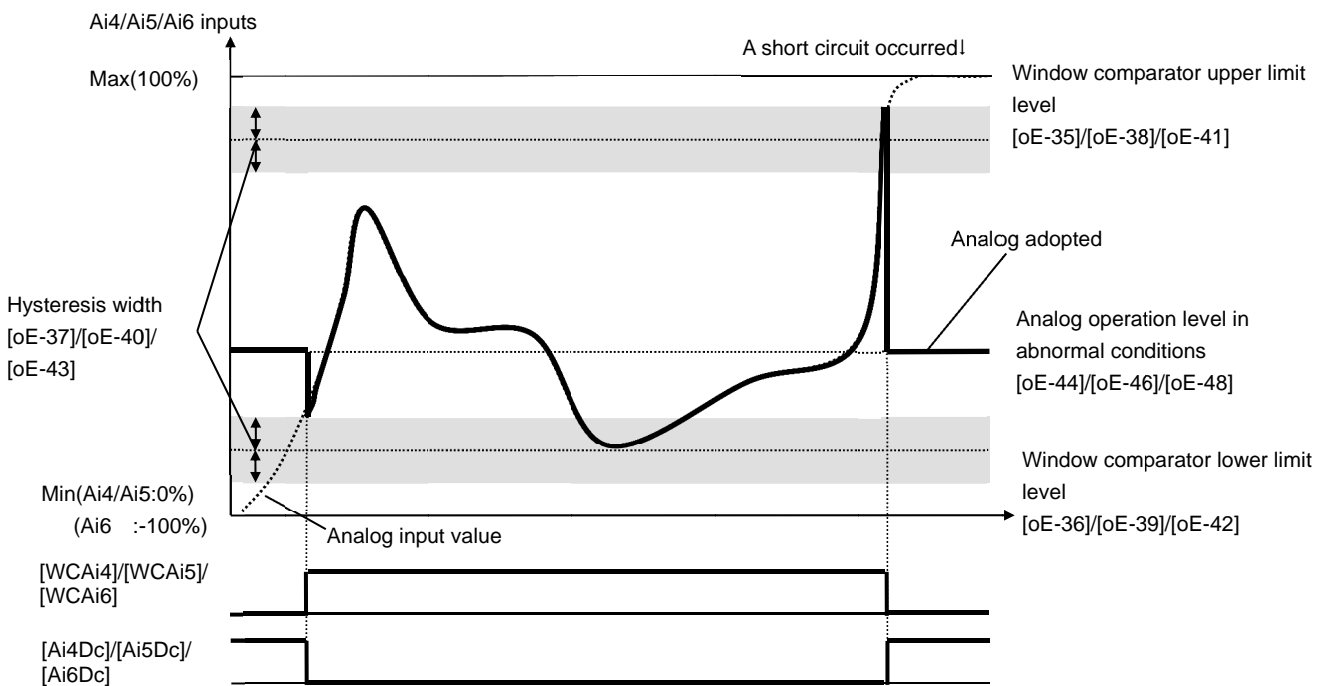

- Output operation in abnormal conditions Example when [oE-45]/[oE-47]/[oE-49] = 01
- When the analog input becomes the minimum value (Min) because of a break in the input wire

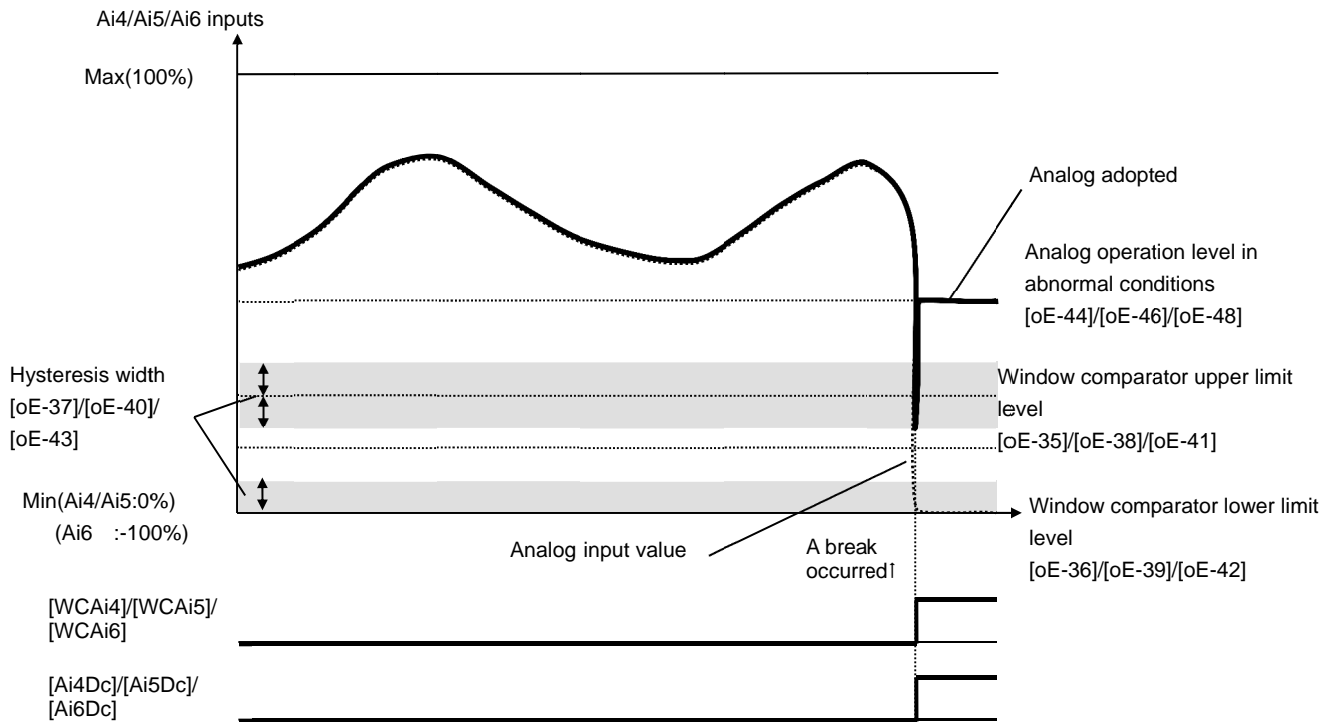

- When the analog input becomes the maximum value (Max) because of a short circuit in the input wire

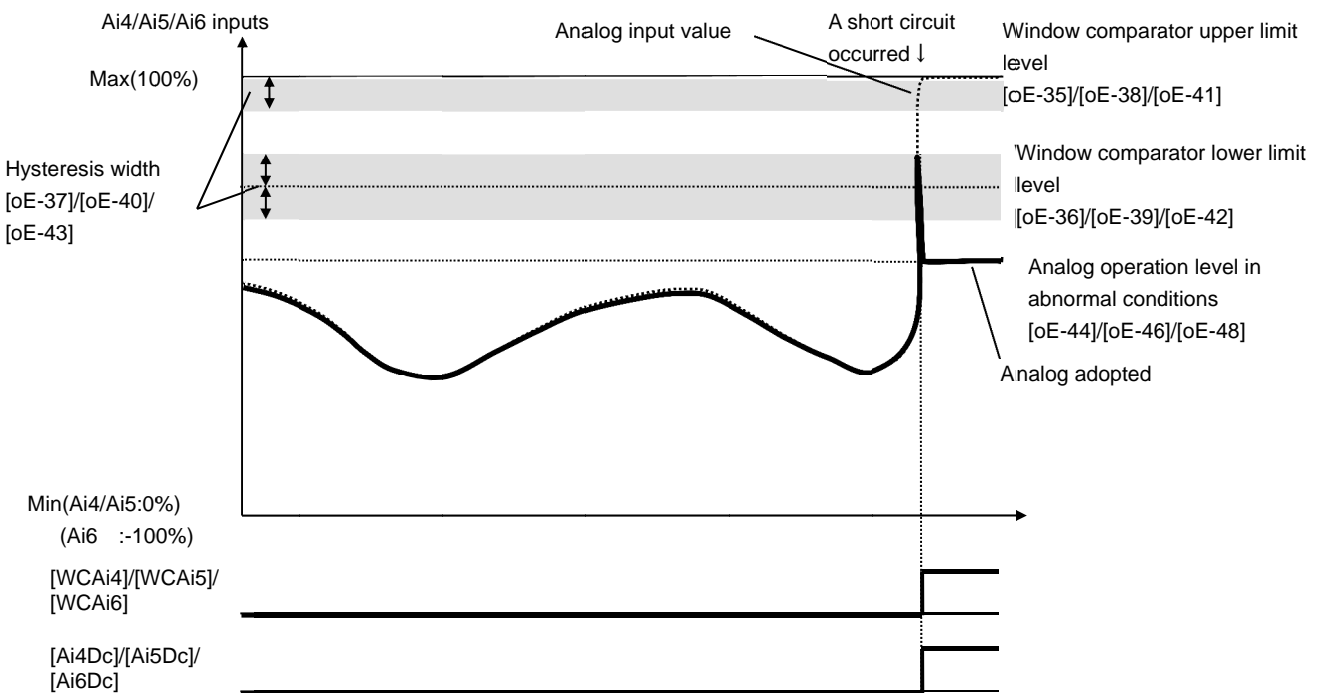

### 12.23 Combining and outputting two output signals



- I want to combine the output terminal function to make signals.



- You can combine the operation of the output terminal function to perform a logical operation for output signals in the inverter to output various signals.
- You can select three types of operators: AND, OR, and XOR.



- All output signals are subject to operation. However, you are not able to include the results of logical operations [LOG1] to [LOG7] into the targets of arithmetic operation.

Selected signal	Arithmetic operation target 1 selection	Arithmetic operation target 2 selection	Operator selection
068: Logical output signal 1 (LOG1)	[CC-40]	[CC-41]	[CC-42]
069: Logical output signal 2 (LOG2)	[CC-43]	[CC-44]	[CC-45]
070: Logical output signal 3 (LOG3)	[CC-46]	[CC-47]	[CC-48]
071: Logical output signal 4 (LOG4)	[CC-49]	[CC-50]	[CC-51]
072: Logical output signal 5 (LOG5)	[CC-52]	[CC-53]	[CC-54]
073: Logical output signal 6 (LOG6)	[CC-55]	[CC-56]	[CC-57]
074: Logical output signal 7 (LOG7)	[CC-58]	[CC-59]	[CC-60]

Example 1) Use a signal for which an AND operation has been performed with a frequency equal to or above the set frequency (003: FA2) and a low current signal (033: LOC), and, when a current lowers after the frequency has been determined, output the signal as Logical output 1 (LOG1) to Output terminal function 1.

- Output terminal function 1 [CC-01]: 062 (LOG1)
- Logical output signal 1 selection 1 [CC-40]: 003 (FA2)
- Logical output signal 1 selection 2 [CC-41]: 033 (LOC)
- Logical output signal 1 operator [CC-42]: 00 (AND)

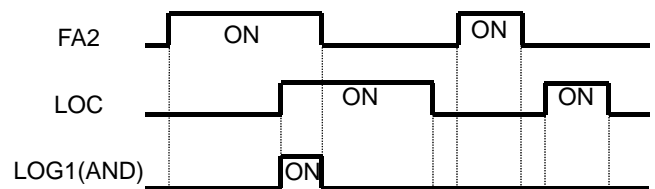

Example 2) Use a signal for which an OR operation has been performed with an overload advance notice signal (035: OL) and a thermal warning signal (026: THM), and, when a current falls outside the range, output the signal as Logical output 3 (LOG3) to Output terminal function 2.

- Output terminal function 2 [CC-02]: 063 (LOG3)
- Logical output signal 3 selection 1 [CC-43]: 035 (OL)
- Logical output signal 3 selection 2 [CC-44]: 026 (THM)
- Logical output signal 3 operator [CC-45]: 01 (OR)

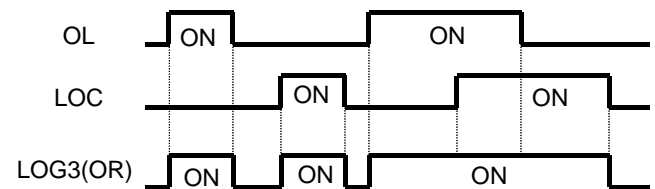

Example 3) Use a signal for which an XOR operation has been performed with an overload advance notice signal (035: OL) and an overload advance notice signal 2 (036: OL2), and, when a current falls within a certain range, output the signal as Logical output 5 (LOG5) to Output terminal function 3.

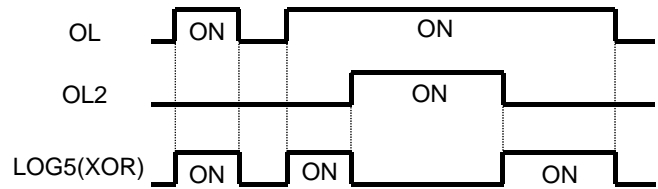

- Output terminal function 3 [CC-03]: 066 (LOG5)
- Logical output signal 5 selection 1 [CC-46]: 035 (OL)
- Logical output signal 5 selection 2 [CC-47]: 036 (OL2)
- Logical output signal 5 operator [CC-48]: 02 (XOR)

■ Parameters

Item	Parameter	Data	Description
Output terminal function selection Relay output terminal function selection	[CC-01]~[CC-05]	062 063 064 065 066 067 068	LOG1: Result of logical operation 1 LOG2: Result of logical operation 2 LOG3: Result of logical operation 3 LOG4: Result of logical operation 4 LOG5: Result of logical operation 5 LOG6: Result of logical operation 6 LOG7: Result of logical operation 7
16C relay output terminal function selection	[CC-06]		
AL relay output terminal function selection	[CC-07]		
Logical output signal selection 1	[CC-40], [CC-43], [CC-46], [CC-49], [CC-52], [CC-55], [CC-58]	Select from the output terminal function selection data (excluding LOG1 to LOG7)	Select Arithmetic operation target 1
Logical output signal selection 2	[CC-41], [CC-44], [CC-47], [CC-50], [CC-53], [CC-56], [CC-59]	Select from the output terminal function selection data (excluding LOG1 to LOG7)	Select Arithmetic operation target 2
Logical output signal operator selection	[CC-42], [CC-45], [CC-48], [CC-51], [CC-54], [CC-57], [CC-60]	00	AND
		01	OR
		02	XOR

## 12.24 What you can achieve by externally inputting signals

### 12.24.1 Using the input signal function externally



- I want to operate the function by inputting a signal into the inverter.
- I want to make a setting to prevent noise from entering into signals.



- Input terminals 1 to 9, A, and B are open collector inputs. Pulse inputting is possible for Terminals A and B.



- For the content of an input signal, by allocating the functions that you want to operate to [CA-01] to [CA-11], you will be able to operate the functions with a corresponding input terminal operation.
- You can switch a contact for an input signal with the Contacts a/b selection functions of [CA-21] to [CA-31].
- When a function is selected for many targets, the targets will be set to 00 [without allocation], excluding the finally set function selection.

#### Parameters

Item	Parameter	Data	Description
Input terminal function selection	[CA-01]~[CA-11]	Next item: Table of input terminal selections	Outputs the allocated function to the corresponding input terminal.
Selection of Input terminals a/b (NO/NC)	[CA-21]~[CA-31]	00	Operates as Contact a (NO).
		01	Operates as Contact b (NC).

#### Terminals corresponding to parameters

Terminal block symbol	Function setting destination parameter
1	[CA-01]
2	[CA-02]
3	[CA-03]
4	[CA-04]
5	[CA-05]
6	[CA-06]
7	[CA-07]
8	[CA-08]
9	[CA-09]
A	[CA-10]
B	[CA-11]

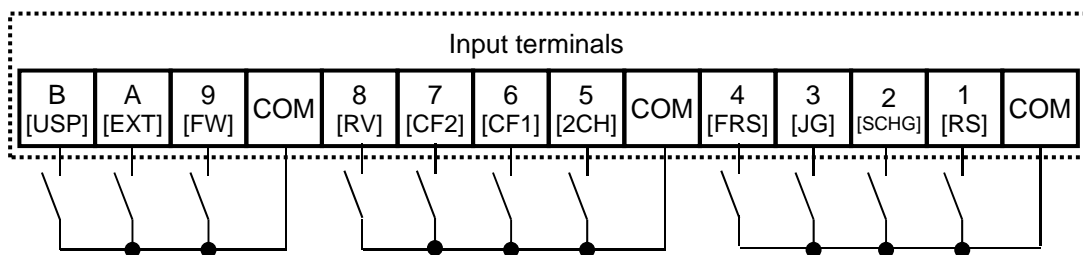



■ Table of input terminal selections

Function No.	Abbreviation	Function name	Page
000	no	Without allocation	-
001	FW	Normal rotation	12-5-3
002	RV	Reverse rotation	12-5-3
003	CF1	Multistage speed 1	12-4-13
004	CF2	Multistage speed 2	12-4-13
005	CF3	Multistage speed 3	12-4-13
006	CF4	Multistage speed 4	12-4-13
007	SF1	Multistage speed bit 1	12-4-14
008	SF2	Multistage speed bit 2	12-4-14
009	SF3	Multistage speed bit 3	12-4-14
010	SF4	Multistage speed bit 4	12-4-14
011	SF5	Multistage speed bit 5	12-4-14
012	SF6	Multistage speed bit 6	12-4-14
013	SF7	Multistage speed bit 7	12-4-14
014	ADD	Addition of frequency	12-4-15
015	SCHG	Switching of instruction	12-4-10
016	STA	3-wire starting up	12-5-4
017	STP	3-wire stopping	12-5-4
018	FR	3-wire normal and reverse	12-5-4
019	AHD	Retention of analog instruction	12-4-17
020	FUP	Acceleration through remote operation	12-4-17
021	FDN	Deceleration through remote operation	12-4-17
022	UDC	Clearing of remote operation data	12-4-17
023	F-OP	Forced switching of instruction	12-5-7
024	SET	Second control	12-17-1
028	RS	Reset	12-24-6
029	JG	Jogging	12-17-4
030	DB	Braking with external direct current	12-14-2 12-15-2
031	2CH	2-step acceleration/deceleration	12-8-5
032	FRS	Stopping of free running	12-15-1
033	EXT	External abnormality	12-16-3
034	USP	Prevention of power restoration restarting	12-16-4
035	CS	Commercial switch	12-17-2
036	SFT	Soft-lock	9-24
037	BOK	Brake check	12-17-5
038	OLR	Switching of overload limit	12-13-11
039	KHC	Clearing of integrated input power	13-14

Function No.	Abbreviation	Function name	Page
040	OKHC	Clearing of integrated output power	13-15
041	PID	PID1 invalidation	12-10-13
042	PIDC	Resetting of PID1 integration	12-10-13
043	PID2	PID2 invalidation	12-10-27
044	PIDC2	Resetting of PID2 integration	12-10-27
045	PID3	PID3 invalidation	12-10-27
046	PIDC3	Resetting of PID3 integration	12-10-27
047	PID4	PID4 invalidation	12-10-27
048	PIDC4	Resetting of PID4 integration	12-10-27
051	SVC1	PID1 multistage target value 1	12-10-9
052	SVC2	PID1 multistage target value 2	12-10-9
053	SVC3	PID1 multistage target value 3	12-10-9
054	SVC4	PID1 multistage target value 4	12-10-9
055	PRO	Switching of PID gain	12-10-14
056	PIO	Switching of PID output	12-10-22
058	SLEP	Satisfaction of SLEEP condition	12-10-17
059	WAKE	Satisfaction of WAKE condition	12-10-17
060	TL	Validation of torque limit	12-11-7
061	TRQ1	Torque limit switchover 1	12-11-7
062	TRQ2	Torque limit switchover 2	12-11-7
063	PPI	Switching of PPI control	12-11-5
064	CAS	Switching of control gain	12-11-2
066	FOC	Auxiliary excitation	12-14-13
067	ATR	Validation of torque control	12-11-13
068	TBS	Validation of torque bias	12-11-11
069	ORT	Orientation	12-17-22
071	LAC	Cancellation of LAD	12-8-11
072	PCLR	Clearing of positional deviation	12-17-25
073	STAT	Permission to inputting of pulse string position instruction	12-17-20
074	PUP	Addition of positional bias	12-17-21
075	PDN	Subtraction of positional bias	12-17-21
076	CP1	Positional instruction selection 1	12-17-27
077	CP2	Positional instruction selection 2	12-17-27
078	CP3	Positional instruction selection 3	12-17-27
079	CP4	Positional instruction selection 4	12-17-27
080	ORL	Origin limit signal	12-17-29
081	ORG	Return-to-origin start up signal	12-17-29
082	FOT	Stopping of normal rotation driving	12-17-30
083	ROT	Stopping of reverse rotation driving	12-17-30
084	SPD	Switching of speed position	12-17-27
085	PSET	Presetting of positional data	12-17-30

Function No.	Abbreviation	Function name	Page
086	Mi1	General purpose input 1	16-6
087	Mi2	General purpose input 2	16-6
088	Mi3	General purpose input 3	16-6
089	Mi4	General purpose input 4	16-6
090	Mi5	General purpose input 5	16-6
091	Mi6	General purpose input 6	16-6
092	Mi7	General purpose input 7	16-6
093	Mi8	General purpose input 8	16-6
094	Mi9	General purpose input 9	16-6
095	Mi10	General purpose input 10	16-6
096	Mi11	General purpose input 11	16-6

Function No.	Abbreviation	Function name	Page
097	PCC	Clearing of pulse counter	12-24-13
098	ECOM	Starting up of EzCOM	14-22
099	PRG	Starting of EzSQ program	16-6
100	HLD	Stopping of acceleration/deceleration	12-8-8
101	REN	Operation permission signal	12-6-4
102	DISP	Fixation of display	12-5-6
103	PLA	Pulse string input A	12-24-13
104	PLB	Pulse string input B	12-24-13
105	EMF	Emergency forced operation	12-17-13
107	COK	Contactork check signal	12-17-10
108	DTR	Data trace starting signal	16-7
109	PLZ	Pulse string input Z	12-17-22
110	TCH	Teaching signal	12-17-28

**12.24.2** Reversing the logical level of input signals



- I want to input reversed input logic for input signals.
- I want to switch Contacts a/b in the inverter.



- Even when the "Selection of Input terminals a/b" is used, a terminal allocated with a "028 [RS] signal" always operates as Contact a (NO).



- You can set input specifications for Contact a or Contact b separately for Input terminals 1 to 9, A, and B.

■ Parameters

Item	Parameter	Data	Description
Input terminal function selection	[CA-01]~[CA-11]	Next item: Table of input terminal selections	Outputs the allocated function to the corresponding input terminal.
Selection of Input terminals a/b (NO/NC)	[CA-21]~[CA-31]	00	Operates as Contact a (NO).
		01	Operates as Contact b (NC).

- Contact a: Closes with "ON," and opens with "OFF."
- Contact b: Closes with "OFF," and opens with "ON."

Input terminal	Switching between Contact a and Contact b
1	[CA-21]
2	[CA-22]
3	[CA-23]
4	[CA-24]
5	[CA-25]
6	[CA-26]
7	[CA-27]
8	[CA-28]
9	[CA-29]
A	[CA-30]
B	[CA-31]

**12.24.3** Adjusting the response to input signals



- I want to delay the response to an input signal.
- I want to prevent as much as possible a signal from fluctuating.



- You can set a response time per input terminal.
- For the correspondence between input terminals and parameters, please refer to the table shown on the right.



- All input signals immediately turn ON/OFF upon a condition is satisfied. Chattering could occur depending on a selected signal. This function is available for retaining/delaying such a signal.

Input terminal	Response time
1	[CA-41]
2	[CA-42]
3	[CA-43]
4	[CA-44]
5	[CA-45]
6	[CA-46]
7	[CA-47]
8	[CA-48]
9	[CA-49]
A	[CA-50]
B	[CA-51]

■ Parameters

Item	Parameter	Data	Description
Input terminal response time	[CA-41]/[CA-42]/[CA-43]/[CA-44]/[CA-45]/[CA-46]/[CA-47]/[CA-48]/[CA-49]/[CA-50]/[CA-51]	0~400(ms)	Sets a response time.

Example) Operation of Input terminal 1

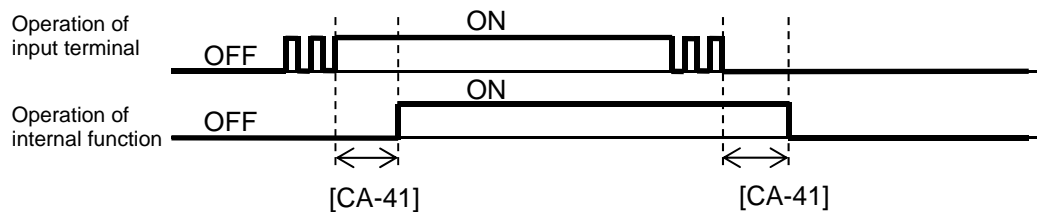

## 12.24.4 Alarm resetting



- I want to release the trip of inverter.
- I want to make an "[RS] reset operation" valid only when a trip has occurred.



- You can release the trip of inverter.
- For resetting, press the Stop/Reset key on the operation panel or turn on the [RS] reset terminal.
- To use the reset terminal, allocate the "028 [RS] reset" to the input terminal function.
- Regardless of the settings, the reset terminal is set to serve as Contact a (NO).
- With the "Reset selection [CA-72]," you can select a timing for releasing the trip with the RS terminal. You can make the "[RS] terminal" valid only at a timing for releasing the trip in the event of an abnormality.



- Do not use the "[RS] reset terminal" in order to interrupt the output of the inverter. To interrupt the output of the inverter with a signal input, use the "[FRS] free run stopping terminal" of the input terminal function.
- You are not able to clear the internal data even when a reset signal is input.
- When a reset signal is input during retry stand-by, the operation starts with the frequency at the time of interruption kept un-cleared.

## Parameters

Item	Parameter	Data	Description
Reset selection	[CA-72]	00	At ON, cancels the trip (Example 1 and 3). At normal: Interrupts the output. At abnormal: Cancels the trip.
		01	At OFF, cancels the trip (Example 2 and 3). At normal: Interrupts the output. At abnormal: Cancels the trip.
		02	At ON, cancels the trip (Examples 1 and 4). At normal: Invalid At abnormal: Cancels the trip.
		03	At OFF, cancels the trip (Examples 2 and 4). At normal: Invalid At abnormal: Cancels the trip.
Reset restarting selection	[bb-41]	00	Starts with 0 Hz
		01	Starts frequency adjustment
		02	Restarts frequency acquisition
Input terminals 1 to 9, A, and B	[CA-01]~[CA-11]	028	RS: Reset function

■ Parameters (continued)

Item	Parameter	Data	Description
Retry stand-by time for instantaneous power failure and insufficient voltage	[bb-26]	0.3~100.0(s)	A stand-by time for restarting after resetting, and after an operation instruction has been given
Lower limit setting for frequency adjustment	[bb-42]	0.00~590.00(Hz)	The lower limit frequency setting for restarting
Restarting level of frequency acquisition	[bb-43]	(0.20 to 2.00) × Inverter rated current	The current limit level when restarting frequency acquisition
Constant (frequency) for frequency acquisition restarting	[bb-44]	0.10~30.00 (sec)	The deceleration rate at the time of frequency acquisition
Constant (voltage) for frequency acquisition restarting	[bb-45]	0.10~30.00 (sec)	The start time of frequency acquisition
Excessive current prevention level at the time of frequency acquisition	[bb-46]	(0.20 to 2.00) × Inverter rated current	The limit current value setting for the excessive current prevention level at the time of frequency acquisition
Start frequency selection at the time of frequency acquisition	[bb-47]	00	Frequency at the time of interruption
		01	Maximum frequency
		02	Set frequency

■ Examples of resetting operations

Example 1) Cancelling the trip at ON ([CA-72]=00,02)

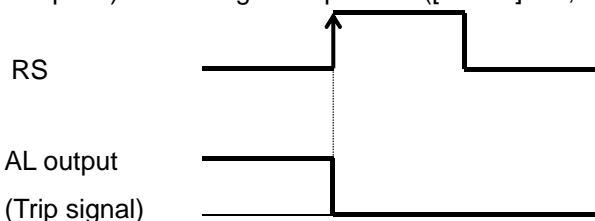

Example 2) Cancelling the trip at OFF ([CA-72]=01,03)

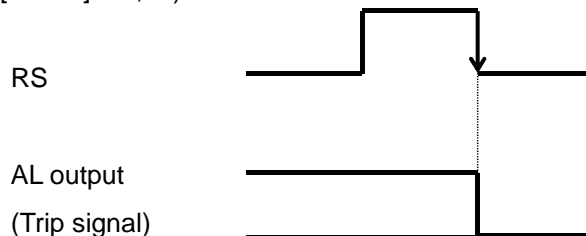

Example 3) Validating resetting at normal ([CA-72]=00,01)

Restarts in accordance with [bb-41]

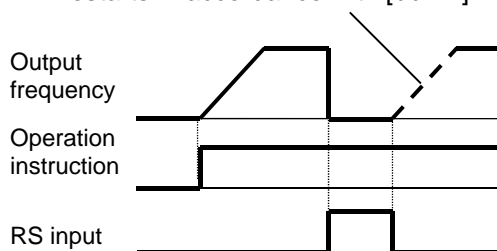

Example 4) Invalidating resetting at normal ([CA-72]=02,03)

Resetting is invalidated during operation.

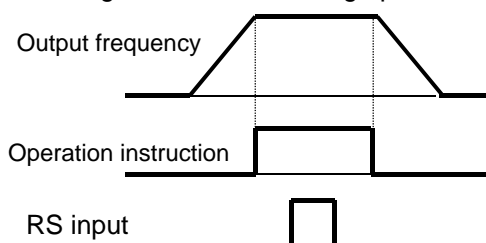

### Examples of restarting when resetting

Example 5) When frequency adjustment restarting is selected ([bb-41]=01)

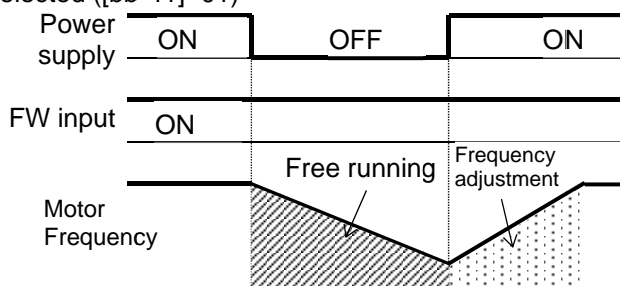

Example 6) When frequency acquisition restarting is selected ([bb-41]=02)

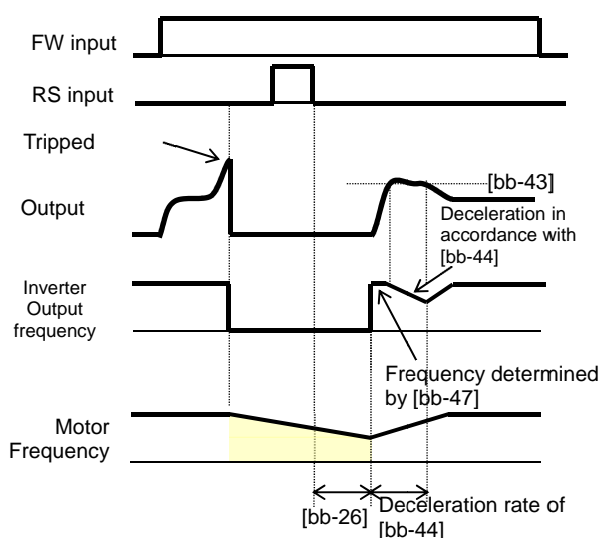

- In the "Reset restarting selection [bb-41]," selecting "01 (frequency adjustment restarting)" allows you to perform the frequency adjustment restarting when turning on the power supply again. When "00 (Restarting with 0 Hz)" is set, the operation starts from 0 Hz without waiting for the "Retry stand-by time for instantaneous power failure and insufficient voltage [bb-26]."



- Even when the frequency adjustment restarting is selected, the "Restarting with 0 Hz" occurs in the cases shown below.
  - When an output frequency is 1/2 of a base frequency or below
  - When the induced voltage of the motor quickly attenuates
  - When the "Lower limit setting for frequency adjustment [bb-42]" is set, and a frequency equal to or below this set frequency is detected



- After the "Retry stand-by time for instantaneous power failure and insufficient voltage [bb-26]" has elapsed, the output starts at a frequency conforming to the "Constant (frequency) for frequency acquisition restarting [bb-44]." After that, during a time of the "Constant (voltage) for restarting [bb-45]," the motor speed is acquired. At that time, to reduce the output current with the "Restarting level of acquisition [bb-43]," deceleration occurs in accordance with the "Constant (frequency) for restarting [bb-44]."
- When the output current lowers below the "Restarting level of acquisition [bb-43]," acceleration starts. If a trip occurs due to an excessive current even in this method, lower the "Restarting level of acquisition [bb-43]" or the "Excessive current prevention level [bb-46]."



- When the "Start frequency selection [bb-47]" is set to "00 (Frequency at the time of interruption)," the operation starts at a frequency at the time of the previous interruption even when a reset signal is input during retry stand-by.

12.24.5 Adjusting analog input

■ Adjusting the relationship between Analog input Ai1 and frequency instruction

Item	Parameter	Data	Description
[Ai1] terminal input filter time constant	[Cb-01]	1~500(ms)	Filters the input.
[Ai1] terminal start amount	[Cb-03]	0.00 ~100.00(%)	Sets a frequency instruction ratio when setting a start ratio for analog input.
[Ai1] terminal end amount	[Cb-04]	0.00 ~100.00(%)	Sets a frequency instruction ratio when setting an end ratio for analog input.
[Ai1] terminal start ratio	[Cb-05]	0.0 ~[Cb-06](%)	With respect to a minimum ratio for analog input for 0 to 10 V/0 to 20 mA, sets a start ratio.
[Ai1] terminal end ratio	[Cb-06]	[Cb-05] ~100.0(%)	With respect to an external frequency instruction for 0 to 10 V, 0 to 20 mA, sets an end ratio.
[Ai1] terminal start selection	[Cb-07]	00	For an instruction for a value of one of 0.00% to the "Start amount [Cb-03]" and to the "End amount [Cb-04]," whichever is lower, one of the values of the "Start amount [Cb-03]" and the "End amount [Cb-04]," whichever is lower, is output.
		01	For an instruction for a value of one of 0.00% to the "Start amount [Cb-03]" and to the "End amount [Cb-04]," whichever is lower, a value of 0.00% is output.

(Example 1-1) [Cb-07]=00

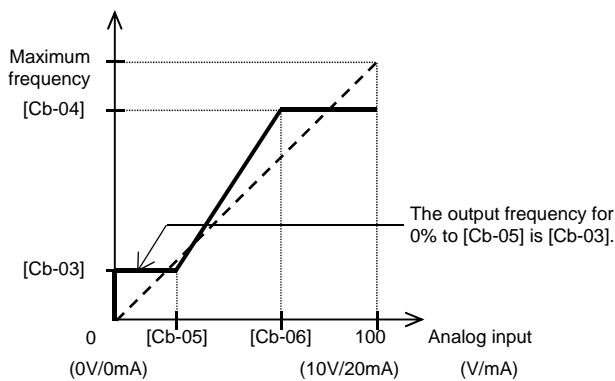

(Example 2-1) [Cb-07]=01

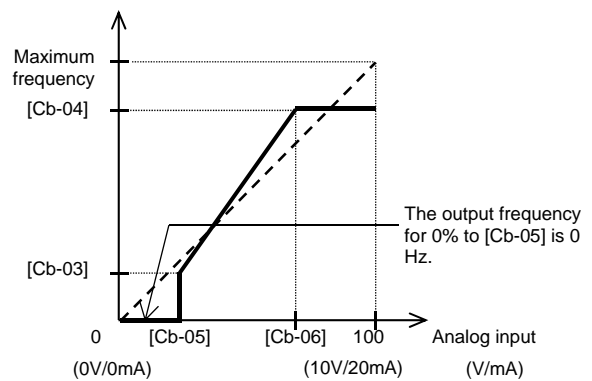

(Example 1-2) [Cb-07]=00

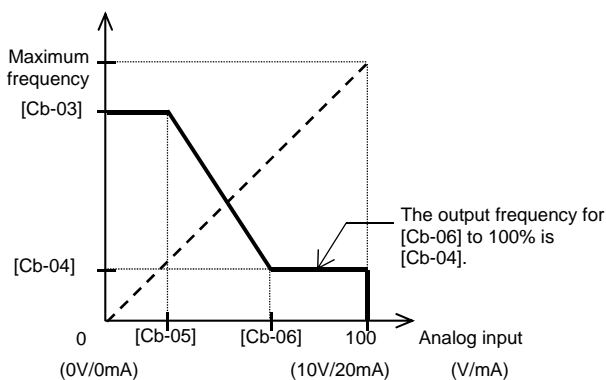

(Example 2-2) [Cb-07]=01

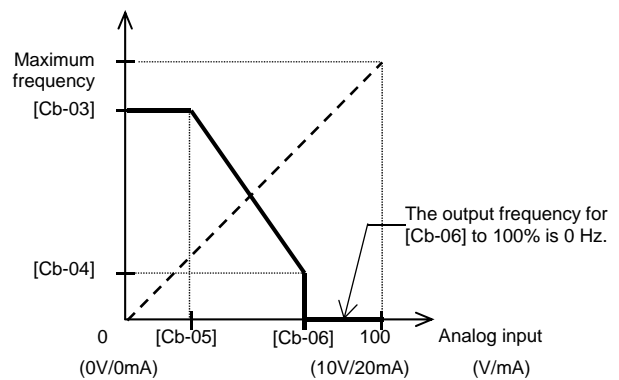



■ Adjusting the relationship between Analog input Ai2 and frequency instruction

Item	Parameter	Data	Description
[Ai2] terminal input filter time constant	[Cb-11]	1~500(ms)	Filters the input.
[Ai2] terminal start amount	[Cb-13]	0.00 ~100.00(%)	Sets a frequency instruction ratio when setting a start ratio for analog input.
[Ai2] terminal end amount	[Cb-14]	0.00 ~100.00(%)	Sets a frequency instruction ratio when setting an end ratio for analog input.
[Ai2] terminal start ratio	[Cb-15]	0.0 ~[Cb-16](%)	With respect to a minimum ratio for analog input for 0 to 10 V/0 to 20 mA, sets a start ratio.
[Ai2] terminal end ratio	[Cb-16]	[Cb-17] ~100.0(%)	With respect to an external frequency instruction for 0 to 10 V, 0 to 20 mA, sets an end ratio.
[Ai2] terminal start selection	[Cb-17]	00	For an instruction for a value of one of 0.00% to the "Start amount [Cb-13]" and to the "End amount [Cb-14]," whichever is lower, one of the values of the "Start amount [Cb-13]" and the "End amount [Cb-14]," whichever is lower, is output.
		01	For an instruction for a value of one of 0.00% to the "Start amount [Cb-14]" and to the "End amount [Cb-15]," whichever is lower, a value of 0.00% is output.

(Example 1-1) [Cb-17]=00

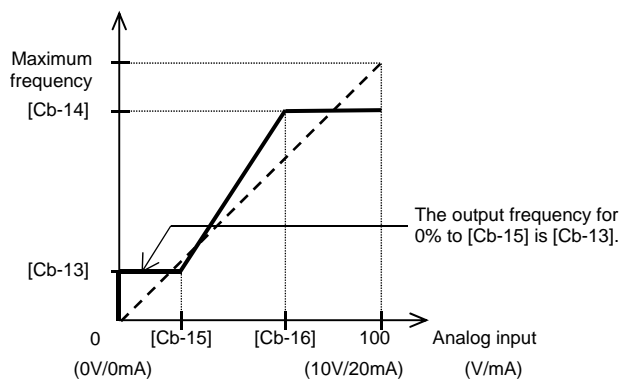

(Example 2-1) [Cb-18]=01

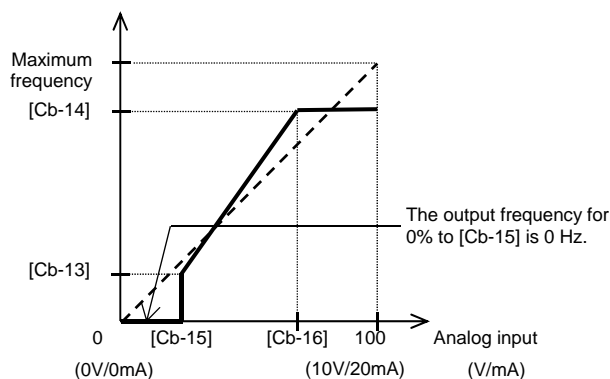

(Example 1-2) [Cb-17]=00

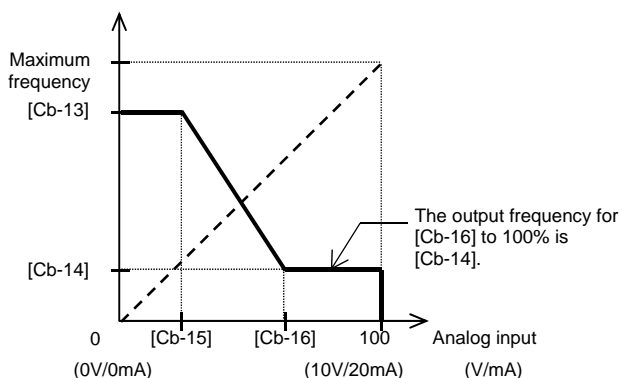

(Example 2-2) [Cb-17]=01

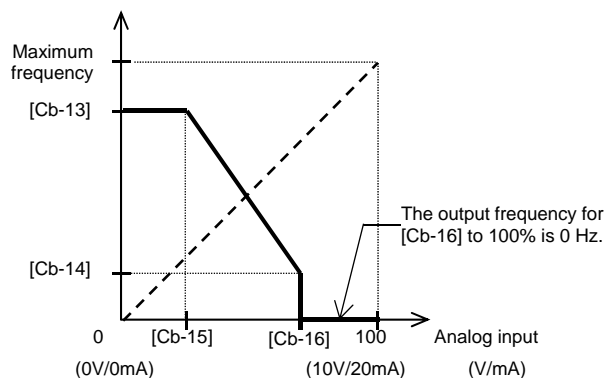

■ Adjusting the relationship between Analog input Ai3 and frequency instruction

Item	Parameter	Data	Description
[Ai3] terminal input filter time constant	[Cb-21]	1~500(ms)	Filters the input.
[Ai3] terminal selection	[Cb-22]	00	Individual
		01	Added to [Ai1]/[Ai2], with reversibility
		02	Added to [Ai1]/[Ai2], without reversibility
[Ai3] terminal start amount	[Cb-23]	-100.00~100.00(%)	Sets a frequency instruction ratio when setting a start ratio for analog input.
[Ai3] terminal end amount	[Cb-24]	-100.00~100.00(%)	Sets a frequency instruction ratio when setting an end ratio for analog input.
[Ai3] terminal start ratio	[Cb-25]	-100.0~[Cb-26](%)	With respect to a minimum ratio for analog input for -10 to 10V, sets a start ratio.
[Ai3] terminal end ratio	[Cb-26]	[Cb-25]~100.0(%)	With respect to an external frequency instruction for -10 to 10 V, sets an end ratio.

(Example 3)

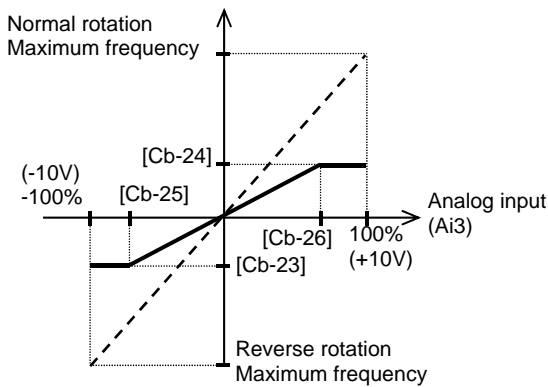

- Adding analog input [Ai3] to [Ai1] and [Ai2]
  - You can forcibly add an input of the [Ai3] terminal to [Ai1]/[Ai2].

(Example 4-1) [Cb-22]=01 (with reversibility)

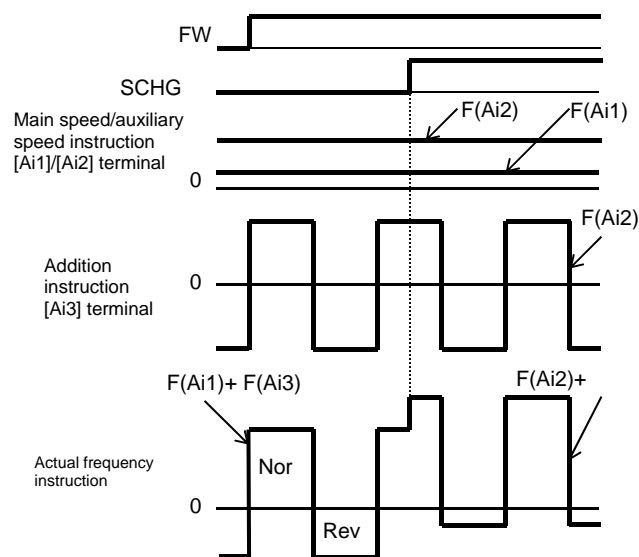

- Stabilizing signals of analog inputs
  - To give a frequency instruction with an external analog signal, you can set a sampling time for voltage input or current input.
  - This feature is effective for removing noise from the frequency setting circuit.

- You are able to make an input of  $\pm 10$  V to the [Ai3] terminal. Use [Cb-22] to select whether the output of reversibility for normal rotation or reverse rotation is possible after making an addition.

(Example 4-2) [Cb-22]=02 (without reversibility)

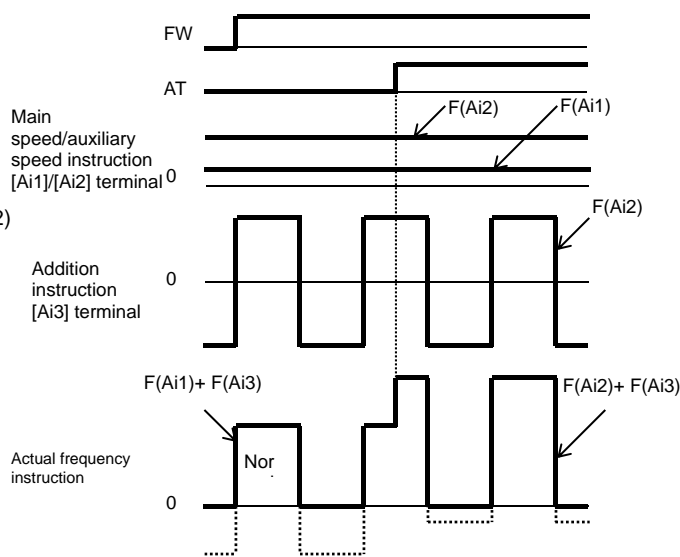

- Increase the set value if noise negatively affects a stable operation. Note that the greater the set value, the lower the responsiveness. When this feature is used for a PID instruction, and a filter is set, the filter would affect the feedback, and therefore a fine operation would not be achieved.

Item	Parameter	Data	Description
[Ai1] terminal input filter time constant	[Cb-01]	1.~500.(ms)	Sets a time constant for the input filter.
[Ai2] terminal input filter time constant	[Cb-11]	1.~500.(ms)	Sets a time constant for the input filter.
[Ai3] terminal input filter time constant	[Cb-21]	1.~500.(ms)	Sets a time constant for the input filter.

### 12.24.6 Checking the number of input pulses



- I want to use the pulse string input to count the pulses for outputting.



- For the pulse counting function, the terminal input monitoring mode and the phase coefficient monitoring mode are available.
- When the "Selection of targets for pulse string input detection [CA-90]" ranges from 00 to 02, the terminal input monitoring mode becomes valid. When [CA-90] is set to "03 (pulse count)," the phase coefficient monitoring mode becomes valid.
- You can monitor the acquired pulses with the pulse counter monitor served as an accumulation counter.
- By turning on [PCC] (Clearing of pulse counter), you can clear the accumulated counter value.



- The maximum input pulse in the phase coefficient monitoring mode becomes a maximum of 32 kpps. (When the duty ratio is approximately 50%)
- An accumulation counter value cannot be stored. After the power supply is turned on, the value becomes zero.
- The maximum input pulse in the terminal input monitoring mode depends on the settings of the input terminal response functions [CA-41] to [CA-51].

#### Parameters

Item	Parameter	Data	Description
Input terminal function	[CA-01]~[CA-11]	103	[PLA]: Accepts a pulse input.
		104	[PLB]: Accepts a pulse input.
		097	[PCC]: Clears the integrated value.
Output terminal function	[CC-01]~[CC-07]	091	[PCMP]: Outputs pulse compare-match signals.
Selection of targets for pulse string input detection	[CA-90]	00	PCNT function
		01	Instruction
		02	Speed feedback
		03	Pulse count
Pulse count compare-match output ON level	[CA-97]	0~65535	When the number of pulses reaches this set value, Turn on [PCMP].
Pulse count compare-match output OFF level	[CA-98]	0~65535	When the number of pulses reaches this set value, Turn off [PCMP].
Maximum value for pulse count compare-match output	[CA-99]	0~65535	A one-shot pulse can be achieved when the value is 0. When the number of pulses reaches the set value, the internal counter is cleared.
Pulse counter monitor	[dA-28]	0~2147483647	Displays the counter integrated value.

■ Terminal input monitoring mode

- Monitors whether the input terminal functions [PLA] and [PLB] are turned on.

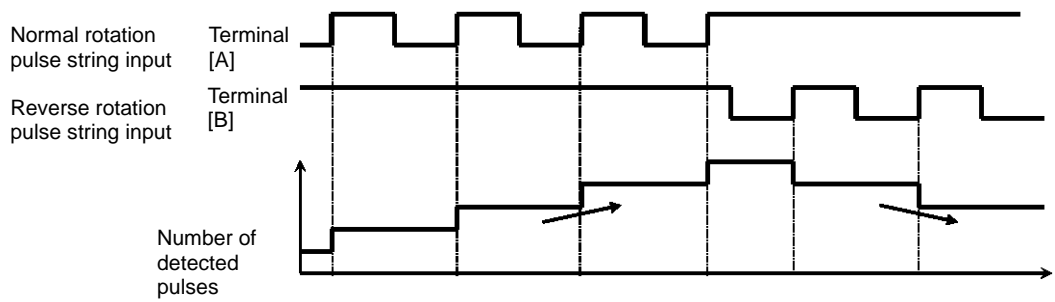

■ Phase coefficient monitoring mode

- Input terminals [A] and [B] become available for pulse string inputs.

(1) Mode 0: [CA-91]=00 90° Phase difference pulse string

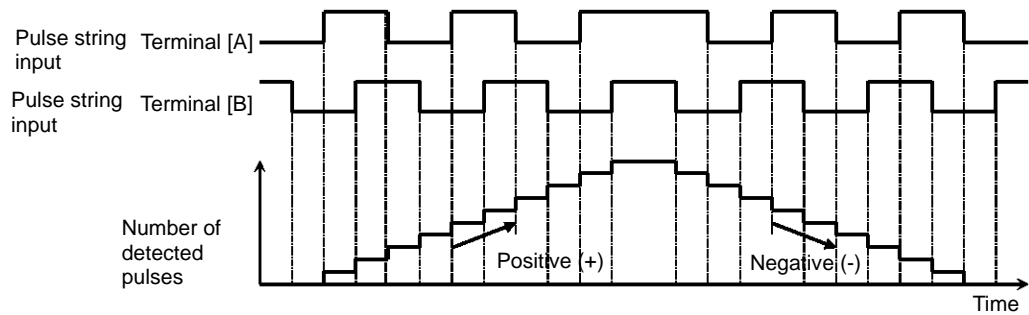

(2) Mode 1: [CA-91]=01 Normal and reverse rotation instruction + Pulse string

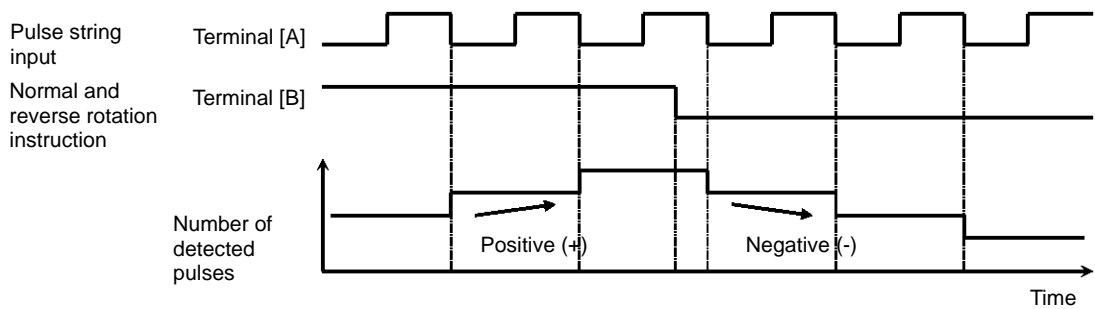

(3) Mode 2: [CA-91]=02 Normal rotation pulse string + Reverse rotation pulse string

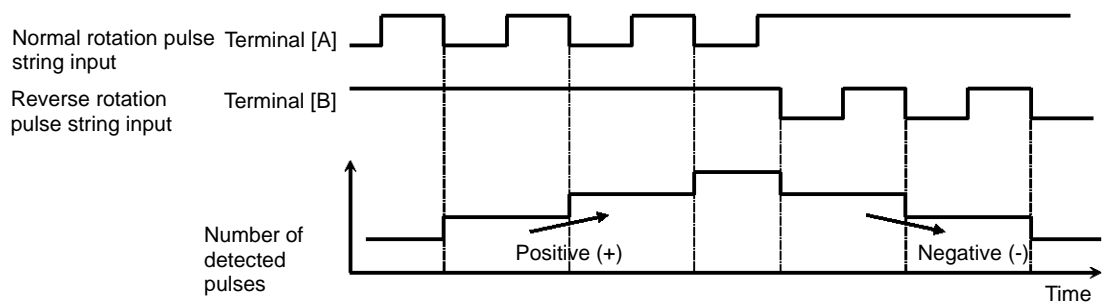

■ Example of pulse counter operation

- The following shows how the pulse counter operates.

- You can monitor the acquired pulses with the pulse counter monitor [dA-28] served as an accumulation counter.

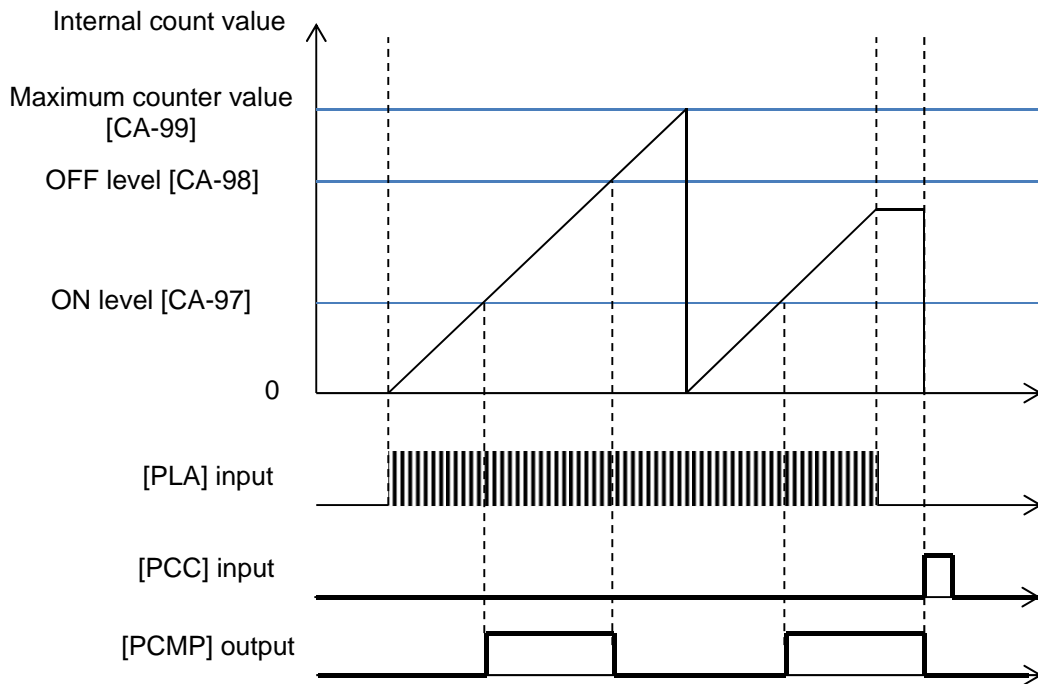

**12.24.7** Performing resetting automatically



- I want to reset an error with an operation for which an operation instruction is turned off.
- I want to perform starting up by releasing a trip automatically when a releasable error occurs.



- When the "[bb-10] automatic reset selection" is set to 01, resetting is performed after the "[bb-12] automatic resetting stand-by time" has elapsed from when an operation instruction has been turned off.
- When the "[bb-10] automatic reset selection" is set to 02, resetting is performed after the "[bb-12] automatic resetting stand-by time" has elapsed from when an error has occurred.

■ Example operation of automatic resetting

Example 1) When [bb-10]=01

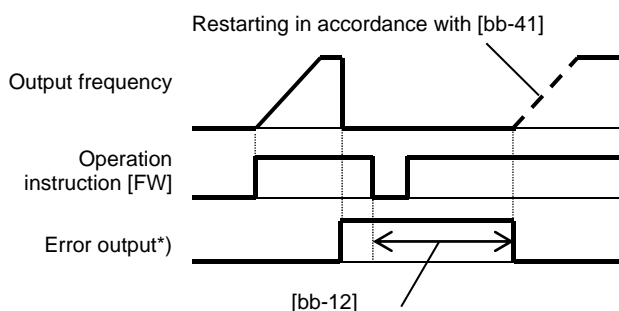

\*) When [bb-11]=00, the error output becomes the "[AL] output."



- When the "[bb-10] automatic reset selection" is set to 01, resetting starts when the STOP/RESET key is pressed as long as an instruction is given through the operation panel.
- When resetting is performed manually, and a control power supply is turned on again, the number of automatic resetting counted in internal is cleared.

- By setting the "Alarm output selection [bb-11]" to 01 while automatic resetting is valid, you can invalidate the output of the "Alarm [AL]" during automatic resetting operation.
- Upon automatic resetting has been performed for the number of times set with the "[bb-13] automatic resetting count setting," no error will be released, but a trip occurs.

Example 2) When [bb-10]=02

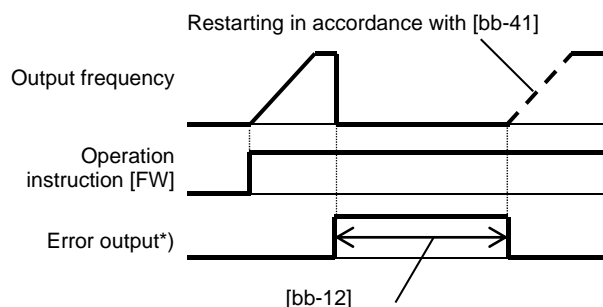

■ Parameters

Item	Parameter	Data	Description
Automatic reset selection	[bb-10]	00	Invalid
		01	Resetting starts when the operation instruction is turned off.
		02	Resetting starts after the set time has elapsed.
Alarm output selection when the automatic resetting is valid	[bb-11]	00	Outputting is available.
		01	Outputting is not available.
Automatic resetting stand-by time	[bb-12]	0~600(s)	Sets a stand-by time from when resetting starts to when actual resetting starts.
Automatic resetting count setting	[bb-13]	0 to 10 (times)	Sets the number of automatic resetting.

## 12.25 What you can achieve by externally outputting signals

### 12.25.1 Using the output signal function externally



- I want to detect warning signals, error signals, and state signals issued by the inverter with an external system.



- Output terminals 11 to 15 are used for open collector output, and Relay output terminals 16 and 17 are used for relay output. Relay output 16 serves as a contact a relay, and Relay output 17 serves as a contact c relay.



- To use the contact c relay, please check the control circuit power supply and the relay output terminals whether they are turned on or off.

- For the content of an output signal, by allocating the functions that you want to output to [CC-01] to [CC-07], you will be able to allow the corresponding output terminal contacts to operate.
- You can switch an output signal level with the Contacts a/b selection functions of [CC-11] to [CC-17].

#### Parameters

Item	Parameter	Data	Description
Output terminal function selection	[CC-01]~[CC-05]	Next item: Table of output terminal selections	Outputs the allocated function to the corresponding output terminal.
Relay output terminal function selection	[CC-06]		
Relay output terminal function selection	[CC-07]		
Output terminal function selection	[CC-11]~CC-15]	00	Operates as Contact a (NO).
Relay output terminal function selection a/b (NO/NC) selection	[CC-16]	01	Operates as Contact b (NC).
Relay output terminal function selection a/b (NO/NC) selection	[CC-17]		

#### Terminals corresponding to parameters

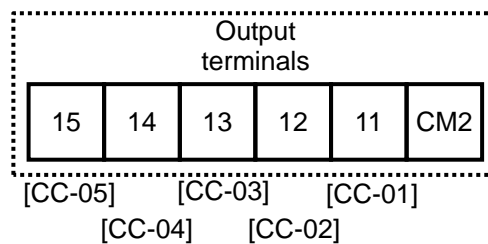
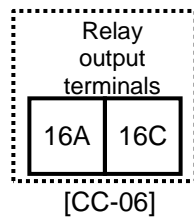
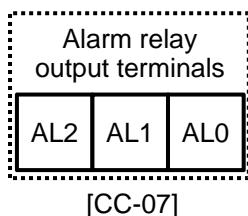



■ Table of output terminal selections

Function No.	Abbreviation	Function name	Page
000	no	Without allocation	-
001	RUN	During operation	12-20-1
002	FA1	When the constant speed is attained	12-21-1
003	FA2	Equal to or above the set frequency	12-21-2
004	FA3	Set frequency only	12-21-3
005	FA4	Equal to or above the set frequency 2	12-21-2
006	FA5	Set frequency only 2	12-21-3
007	IRDY	Operation ready completion	12-20-4
008	FWR	During normal rotation operation	12-20-2
009	RVR	During reverse rotation operation	12-20-2
010	FREF	Frequency command panel	12-4-2
011	REF	Operation command panel	12-5-2
012	SETM	Second control under selection	12-17-1
016	OPO	Optional output	14-41
017	AL	Alarm signal	12-19-1
018	MJA	Severe failure signal	12-19-3
019	OTQ	Excessive torque	12-11-9
020	IP	During instantaneous power failure	12-19-8
021	UV	Under insufficient voltage	12-19-9
022	TRQ	During torque limitation	12-11-8
023	IPS	During power failure deceleration	12-13-18
024	RNT	RUN time elapsed	12-19-15
025	ONT	Power supply ON time elapsed	12-19-16
026	THM	Electronic thermal warning (motor)	12-19-10
027	THC	Electronic thermal warning (inverter)	12-19-11
029	WAC	Capacitor life advance notice	12-19-13
030	WAF	Fan life advance notice	12-19-14
031	FR	Operation command signal	12-20-3
032	OHF	Cooling fin heating advance notice	12-19-12
033	LOC	Low current signal	12-19-7
034	LOC2	Low current signal 2	12-19-7
035	OL	Overload advance notice	12-19-6
036	OL2	Overload advance notice 2	12-19-6
037	BRK	Brake release	12-17-5
038	BER	Brake abnormality	12-17-5
039	CON	Contact control	12-17-10

Function No.	Abbreviation	Function name	Page
040	ZS	0 Hz detection signal	12-21-4
041	DSE	Excessive speed deviation	12-16-11
042	PDD	Excessive positional deviation	12-17-21
043	POK	Positioning completed	12-17-22
044	PCMP	Pulse count compare-match	12-24-13
045	OD	PID excessive deviation	12-10-28
046	FBV	PID feedback comparison	12-10-29
047	OD2	PID2 excessive deviation	12-10-28
048	FBV2	PID2 feedback comparison	12-10-29
049	NDc	Communication disconnection	14-5
050	Ai1Dc	Analog disconnection Ai1	12-22-1
051	Ai2Dc	Analog disconnection Ai2	12-22-1
052	Ai3Dc	Analog disconnection Ai3	12-22-1
053	Ai4Dc	Analog disconnection Ai4	12-22-4
054	Ai5Dc	Analog disconnection Ai5	12-22-4
055	Ai6Dc	Analog disconnection Ai6	12-22-4
056	WCAi1	Window comparator Ai1	12-22-1
057	WCAi2	Window comparator Ai2	12-22-1
058	WCAi3	Window comparator Ai3	12-22-1
059	WCAi4	Window comparator Ai4	12-22-4
060	WCAi5	Window comparator Ai5	12-22-4
061	WCAi6	Window comparator Ai6	12-22-4
062	LOG1	Result of logical operation 1	12-23-1
063	LOG2	Result of logical operation 2	
064	LOG3	Result of logical operation 3	
065	LOG4	Result of logical operation 4	
066	LOG5	Result of logical operation 5	
067	LOG6	Result of logical operation 6	
068	LOG7	Result of logical operation 7	
069	MO1	General purpose output 1	16-6
070	MO2	General purpose output 2	
071	MO3	General purpose output 3	
072	MO4	General purpose output 4	
073	MO5	General purpose output 5	
074	MO6	General purpose output 6	
075	MO7	General purpose output 7	

Function No.	Abbreviation	Function name	Page
076	EMFC	During-Em-Force signal	12-17-13
077	EMBP	During-bypass-mode signal	12-17-15
078	WFT	Trace function trigger stand-by signal	16-7
079	TRA	Trace function during-tracing signal	16-7
080	LBK	Operation panel battery insufficient	9-36
081	OVS	Excessive voltage of accepted power	12-19-17
084	AC0	Alarm code bit 0	12-19-4
085	AC1	Alarm code bit 1	
086	AC2	Alarm code bit 2	
087	AC3	Alarm code bit 3	
089	OD3	PID3 excessive deviation	12-10-28
090	FBV3	PID3 feedback comparison	12-10-29
091	OD4	PID4 excessive deviation	12-10-28
092	FBV4	PID4 feedback comparison	12-10-29
093	SSE	PID soft start abnormality	12-10-16

**12.25.2** Reversing the output level of output signals



- I want to output a reversed output level for output signals.
- I want to switch Contacts a/b in the inverter.



- You can set output specifications for Contact a or Contact b separately for Output terminals 11 to 15 and Relay output terminals 16 and 17.

■ Parameters

Item	Parameter	Data	Description
Output terminal function selection	[CC-11] ~ [CC-15]	00、01	00: Contact a (normally open) operation 01: Contact b (normally closed) operation
Relay output terminal function selection a/b (NO/NC) selection	[CC-16]		
Relay output terminal function selection a/b (NO/NC) selection	[CC-17]		

- Contact a: Closes with "ON," and opens with "OFF."
- Contact b: Closes with "OFF," and opens with "ON."

■ Open collector output terminals

- The specifications of Output terminals 11 to 15 are as shown below. The same specifications are applied.

- The open collector output operation is as shown below.

	Electrical characteristics
Terminals (11 to 15)-CM2	Voltage drop at ON: 4 V or below Allowable maximum voltage: DC 27 V Allowable maximum current: 50 mA

[CC-11]~ [CC-15]	Control power supply	Output of inverter function	Open collector operation
00 (Contact a)	On	ON	Close
	Off	OFF	Open
01 (Contact b)	On	ON	Open
	Off	OFF	Close

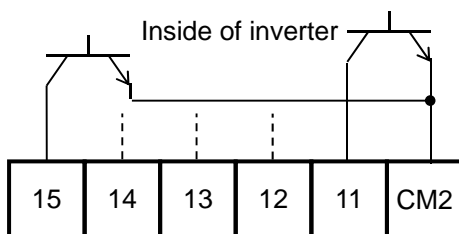

- Relay 1a output terminals
- The specifications of Relay 1a output terminals 16A to 16C are as shown below.

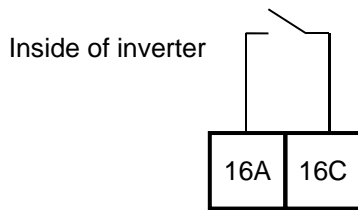

	Electrical characteristics
16A-16C	Voltage drop at ON: 4 V or below Allowable maximum voltage: DC 27 V Allowable maximum current: 50 mA

- The operations of 16A to 16C are as shown below.

[CC-16]	Control power supply	Output of inverter function	Relay operation
00 (Contact a)	On	ON	Close
		OFF	Open
01 (Contact b)	On	-	Open
		ON	Open
	Off	OFF	Close
	Off	-	Open

- Relay 1c output terminals
- The specification of Relay 1c output terminals AL1 to AL0/AL2 to AL0 are as shown below.

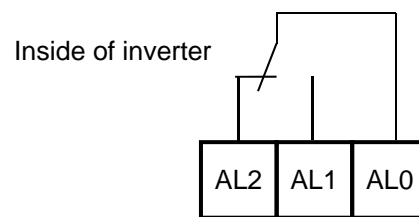

		Resistance load	Induced load
AL1-AL0	Maximum contact capacity	AC250V, 2A DC30V, 3A	AC250V, 0.2A DC30V, 0.6A
	Minimum contact capacity	AC100V, 10mA DC5V, 100mA	
AL2-AL0	Maximum contact capacity	AC250V, 1A DC30V, 1A	AC250V, 0.2A DC30V, 0.2A
	Minimum contact capacity	AC100V, 10mA DC5V, 100mA	

- The operations of AL1 to AL0/AL2 to AL0 are as shown below.

[CC-17]	Control power supply	Output of inverter function	Output terminal state	
			AL1-AL0	AL2-AL0
00	On	ON	Close	Open
		OFF	Open	Close
	Off	-	Open	Close
01 (Initial value)	On	ON	Open	Close
		OFF	Close	Open
	Off	-	Open	Close

**12.25.3** Delaying and retaining output signals



- I want to delay the response to an output signal.
- I want to reduce fluctuation of signal as much as possible.



- All output signals immediately turn ON/OFF upon a condition is satisfied. Chattering could occur depending on a selected signal. This function is available for retaining/delaying such a signal.



- You can set an on-delay/off-delay time per output terminal.
- You can make a setting per output terminal. For the correspondence between output terminals and parameters, please refer to the table shown on the right.

Output terminals	On-delay time	Off-delay time
11	[CC-20]	[CC-21]
12	[CC-22]	[CC-23]
13	[CC-24]	[CC-25]
14	[CC-26]	[CC-27]
15	[CC-28]	[CC-29]
16A-16C	[CC-30]	[CC-31]
AL1-AL0/ AL2-AL0	[CC-32]	[CC-33]

■ Parameters

Item	Parameter	Data	Description
Output on-delay time	[CC-20]/[CC-22]/ [CC-24]/[CC-26]/ [CC-28]/[CC-30]/ [CC-32]	0.00~100.00(s)	Sets an on-delay time.
Output off-delay time	[CC-21]/[CC-23]/ [CC-25]/[CC-27]/ [CC-29]/[CC-31]/ [CC-33]	0.00~100.00(s)	Sets an off-delay time.

Example) Operation of Output terminal 11

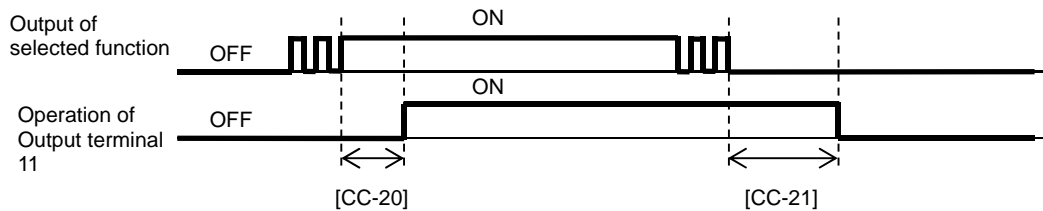

### 12.25.4 Selecting data to be output

**Q**

- I want to cause an analog output terminal to perform an output as inverter information.
- Selectable parameter codes
- The below table shows selectable parameter codes.
- The output scale ranges are specified when bias settings are each set to 0.0%, and gain settings are each set to 100.0%.

**A**

- You can select, using some parameter codes, data to be output to the Analog output Ao1-L and Ao2-L terminals and the Digital pulse output FM-CM1 terminal.
- You can adjust the output scale ranges with bias settings and gain settings.
- Using the bias function, you can output "(±) data," "(-) data" in a range from which outputting is available.

Code	Name	Output scale range (Corresponding to 0 to 10 V / 0 to 20 mA / 0 to 100%)	Remarks
dA-01	Output frequency monitor	0.00 to Maximum speed (Hz)	Outputting is possible with (±).
dA-02	Output current monitor	(0.00 to 2.00) × Inverter rated current (A)	Outputting is possible with (±).
dA-04	Frequency command	0.00 to Maximum speed (Hz)	Outputting is possible with (±).
dA-10	Estimated speed value monitor	0.00 to Maximum speed (Hz)	Outputting is possible with (±).
dA-15	Torque command monitor	0 to Motor rated torque × 500% (Nm)	Outputting is possible with (±).
dA-16	Torque limit monitor	0 to Motor rated torque × 500% (Nm)	Outputting is possible with (±).
dA-17	Output torque monitor	0 to Motor rated torque × 500% (Nm)	Outputting is possible with (±).
dA-18	Output voltage monitor	0 to Rated voltage × 133% (V)	
dA-30	Input power monitor	0.00 to Rated power × 200% (kW)	
dA-34	Output power monitor	0.00 to Rated power × 200% (kW)	
dA-40	DC voltage monitor	(200 V class) 0.0 to 400.0 (Vdc) (400 V class) 0.0 to 800.0 (Vdc)	
dA-41	Braking circuit (BRD) duty ratio monitor	0.00~100.00(%)	
dA-42	Electronic thermal duty ratio monitor (motor)	0.00~100.00(%)	
dA-43	Electronic thermal duty ratio monitor (inverter)	0.00~100.00(%)	

Code	Name	Output scale range (Corresponding to 0 to 10 V / 0 to 20 mA / 0 to 100%)	Remarks
dA-61	Analog input [Ai1] monitor	0.00~100.00(%)	
dA-62	Analog input [Ai2] monitor	0.00~100.00(%)	
dA-63	Analog input [Ai3] monitor	-100.00~100.00(%)	Outputting is possible with (±).
dA-70	Pulse string input monitor (main body)	-100.00~100.00(%)	Outputting is possible with (±).

Code	Name	Output scale range (Corresponding to 0 to 10 V / 0 to 20 mA / 0 to 100%)	Remarks
db-18	Analog output monitor YA1	0.00~10000	
db-19	Analog output monitor YA2	0.00~10000	
db-20	Analog output monitor YA3	0.00~10000	
db-30	PID1 feedback data 1 monitor	-100.00~100.00(%)	Outputting is possible with (±).
db-32	PID1 feedback data 2 monitor	-100.00~100.00(%)	Outputting is possible with (±).
db-36	PID2 feedback data monitor	-100.00~100.00(%)	Outputting is possible with (±).
db-42	PID1 target value monitor	-100.00~100.00(%)	Outputting is possible with (±).
db-44	PID1 feedback data monitor	-100.00~100.00(%)	Outputting is possible with (±).
db-50	PID1 output monitor	-100.00~100.00(%)	Outputting is possible with (±).
db-51	PID1 deviation monitor	-100.00~100.00(%)	Outputting is possible with (±).
db-52	PID1 deviation 1 monitor	-100.00~100.00(%)	Outputting is possible with (±).
db-53	PID1 deviation 2 monitor	-100.00~100.00(%)	Outputting is possible with (±).
db-55	PID2 output monitor	-100.00~100.00(%)	Outputting is possible with (±).
db-56	PID2 deviation monitor	-100.00~100.00(%)	Outputting is possible with (±).
db-64	PID feedforward monitor	0.00~100.00(%)	
dC-15	Cooling fin temperature monitor	-20.0~200.0(°C)	

Code	Name	Output scale range (Corresponding to 0 to 10 V / 0 to 20 mA / 0 to 100%)	Remarks
FA-01	Main speed command monitor	0.00~590.00(Hz)	
FA-02	Auxiliary speed command monitor	0.00~590.00(Hz)	
FA-15	Torque command monitor	Motor rated torque × (-500.0 to 500.0(%))	Outputting is possible with (±).
FA-16	Torque bias command monitor	Motor rated torque × (-500.0 to 500.0(%))	Outputting is possible with (±).
FA-30	PID1 target value 1	0.00~100.00(%)	
FA-32	PID1 target value 2	0.00~100.00(%)	
FA-36	PID2 target value	0.00~100.00(%)	



## 12.25.5 Pulse-outputting data



- As inverter information, I want to output information externally with pulse outputting.
- I want to obtain data using the digital frequency counter.



- With the FM output function, you can make selections from the PWM output in which a duty ratio changes and the digital frequency output in which a frequency changes.



- The finally determined output does not exceed an output range of the [FM] output terminal.
- When [Cd-10]=01 is set, [FM], [Ao1], and [Ao2] respectively perform outputs in accordance with the values of [Cd-15], [Cd-25], and [Cd-35].

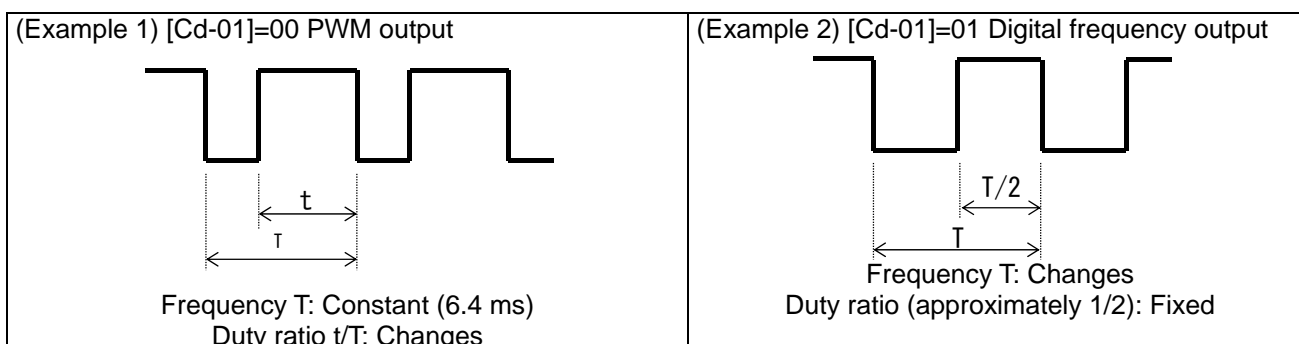

## ■ Parameters

Item	Parameter	Data	Description
[FM] terminal output form selection	[Cd-01]	00	PWM output (Frequency: 6.4 ms)
		01	Digital frequency output
[FM] terminal standard frequency (during digital frequency output)	[Cd-02]	0~3600[Hz]	[FM] terminal output frequency in the full scale.
[FM] terminal output selection	[Cd-03]	Parameter number for "12.25.4 Selecting data to be output"	Sets a parameter number.
Analog monitor adjustment mode selection	[Cd-10]	00	Invalid.
		01	Valid. Outputs to terminals output levels in the adjustment mode.
[FM] output filter time constant	[Cd-11]	1~500[ms]	Filters FM output data.
[FM] output data type selection	[Cd-12]	00	Outputs the absolute value of data.
		01	Outputs data with a symbol.
[FM] Bias	[Cd-13]	-100.0~100.0[%]	Biases data to adjust Point 0 of data.
[FM] gain	[Cd-14]	-1000.0~1000.0[%]	Apply a gain to data to adjust an inclination in data.
[FM] output level in the adjustment mode	[Cd-15]	-100.0~100.0[%]	Sets output in the adjustment mode. It selects the maximum output (at 100.0%), the minimum output (at 0.0%) ([Cd-12]=00), or the minimum output (at -100.0%) ([Cd-12]=01).

■ [Cd-01] [FM] terminal output form selection is set to 00

- With the "Bias adjustment [Cd-13]" of the "PWM output," you can bias Point 0 as shown in the below figure.

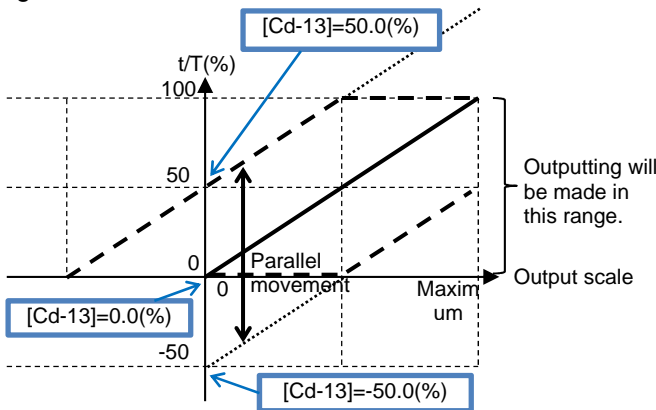

(Example) PWM-outputting [dA-01] output frequency monitor

- I want to perform outputting until a frequency reaches the maximum frequency when the PWM output is 100%.

[Cd-13]=0.0%, [Cd-14]=100.0%

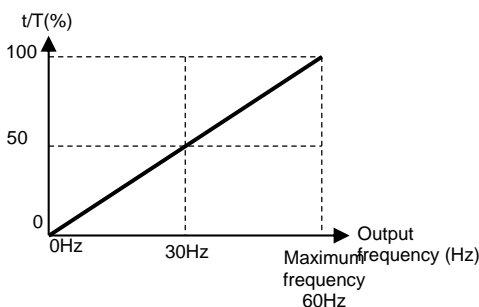

(Example) PWM-outputting [dA-02] output current monitor

- I want to perform outputting until a current reaches the inverter rated current when the PWM output is 100%.

[Cd-13]=0.0%, [Cd-14]=200.0%

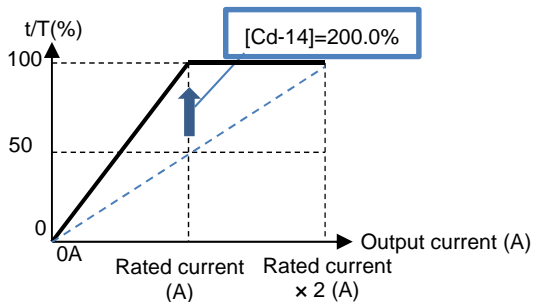

- With the "Gain adjustment [Cd-14]" of the "PWM output," you can change an inclination as shown in the below figure.

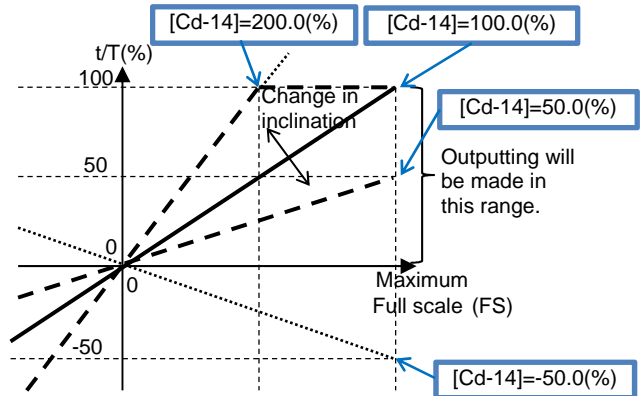

(Example) PWM-outputting [dA-18] output voltage monitor

- I want to monitor the output voltage.

[Cd-13]=0.0%, [Cd-14]=133.0%

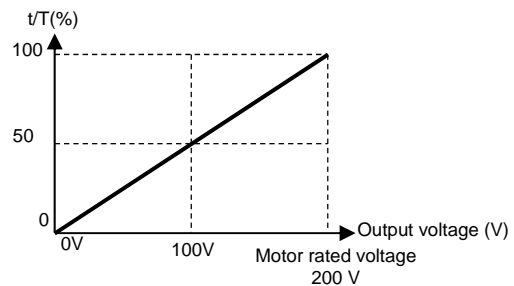

(Example) PWM-outputting [dA-17] output torque monitor

- I want to apply a PWM output range from 0 to 100% in a torque range from -200 to 200%.

[Cd-12]=01, [Cd-13]=50.0%, [Cd-14]=50.0%

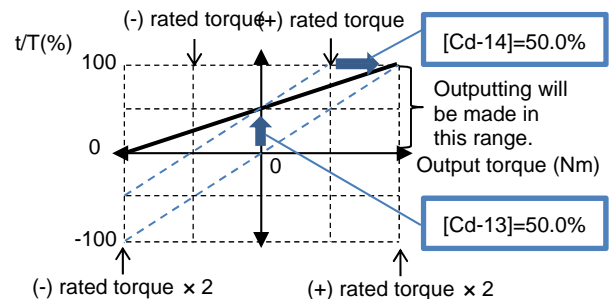

(Example) PWM-outputting [dA-17] output torque monitor

- I want to apply a PWM output range from 0 to 100% in a torque range from 0% to  $\pm 200\%$ .

[Cd-12]=00, [Cd-13]=0.0%, [Cd-14]=100.0%

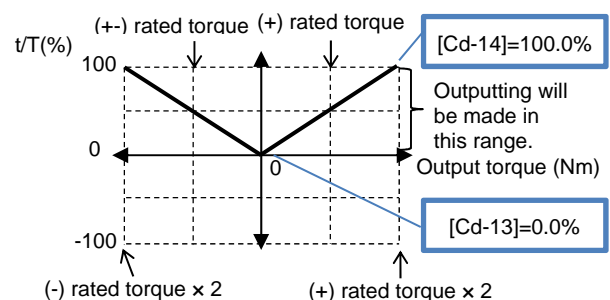

- [Cd-01] [FM] terminal output form selection is set to 01
- With the "Bias adjustment [Cd-13]" of the "Digital frequency output," you can bias Point 0 as shown in the below figure.

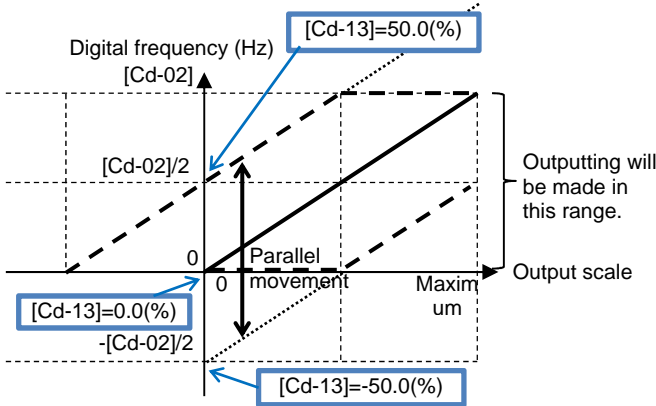

- (Example) Digital-frequency-outputting information on [dA-01] output frequency monitor
- I want to perform outputting so that the maximum value of the "Digital frequency output" corresponds to the maximum frequency.

When the maximum frequency is 60 Hz, set [Cd-02]=60Hz.  
[Cd-13]=0.0%、[Cd-14]=100.0%

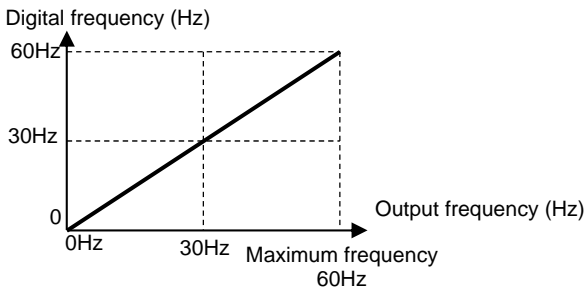

- With the "Gain adjustment [Cd-14]" of the "Digital frequency output," you can change an inclination as shown in the below figure.

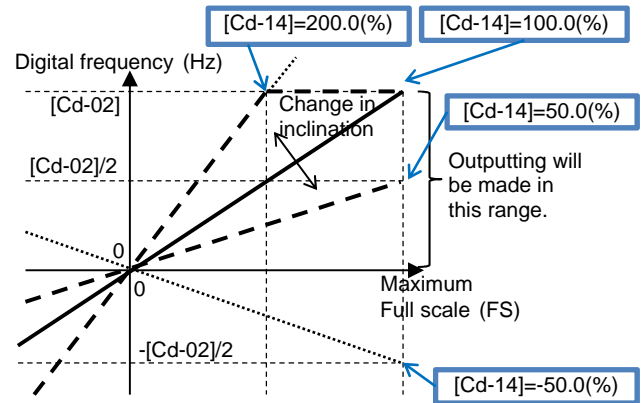

(Example) Digital-frequency-outputting information on [dA-02] output current monitor

- I want to perform outputting at a frequency of 1500 Hz when a current corresponding to the inverter rated current flows.  
Set [Cd-02]=3000Hz.  
[Cd-13]=0.0%、[Cd-14]=100.0%

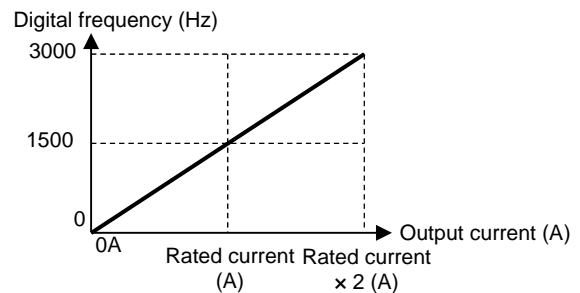

or

- Set [Cd-02]=1500Hz.  
[Cd-13]=0.0%、[Cd-14]=200.0%

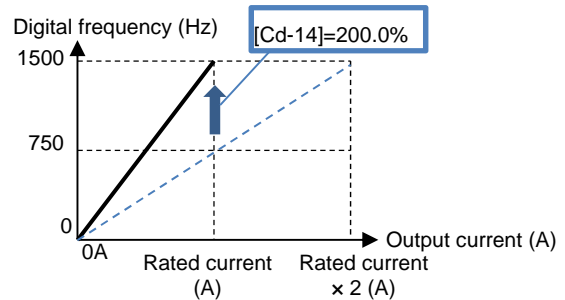

- Analog monitor adjustment mode: [FM] output
- Setting the analog monitor adjustment mode [Cd-10] to 01 fixes the output of the [FM] output terminal.

(Example) Outputting the output current monitor with the PWM output

- I want to perform outputting with a PWM output of 100% when a current corresponding to the inverter rated current flows.  
(The standard point is the inverter rated current.)

Code	Name	Output scale range (Corresponding to 0 to 10 V / 0 to 20 mA)
dA-02	Output current monitor	(0.00 to 2.00) × Inverter rated current (A)

**1** Set [Cd-01]=00 and [Cd-03]=(dA-02). Setting [Cd-10] to 01 outputs PWM from the [FM] terminal in accordance with [Cd-12].

**2** When the standard point at which you want to perform outputs is the rated current value, since the rated current has a maximum scale of Rated current × 2.00, set a point that is half of it. First set [Cd-12] to 50.0% (corresponding to the inverter rated current).

In this state, since the full scale of the output current monitor is Rated current × 2.00, the [FM] terminal outputs PWM of 50% duty, which is an output at the rated current (= Rated current × 2.00 × 50.0%).

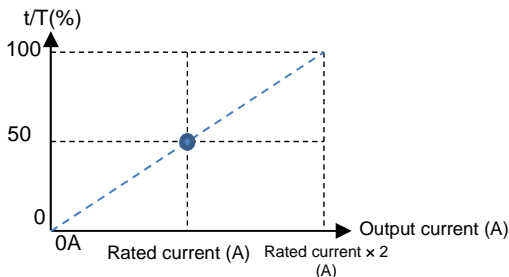

- With the fixed output, an output set with [Cd-12] is made for the full-scale value of the monitor selected with [Cd-03].

**3** Adjust the inclination with [Cd-14]. Change [Cd-14] to make an adjustment toward the point from which PWM of 100% duty is output.  
(For example, see and wait with a range from 190.0% to 210.0%.)

[Cd-13]=0.0%, [Cd-14]=200.0%

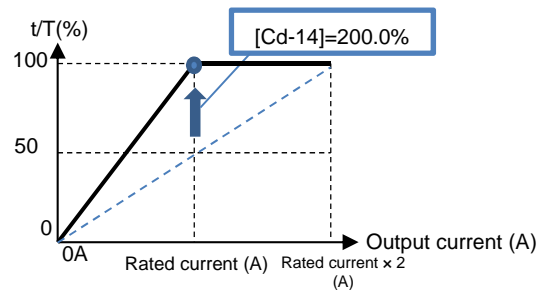

**4** Returning [Cd-10] to 00 starts the PWM output of [FM] that is adjusted.

## 12.25.6 Outputting data with voltage/current



- As inverter information, I want to output information externally with a voltage.
- As inverter information, I want to output information externally with a current.



- With Analog output terminals Ao1 and Ao2, you can select voltage output or current output by operating Switches SW3 and SW4 on the substrate.



- For outputs of [Ao1] and [Ao2], voltage output has an initial value in a range from 0 to 10 V, and current output has an initial value in a range from 4 to 20 mA.
- Operate the switches on the substrate while the inverter power supply is turned off.
- When [Cd-10]=01 is set, [FM], [Ao1], and [Ao2] respectively perform outputs in accordance with values of [Cd-15], [Cd-25], and [Cd-35].

## Parameters

Item	Parameter	Data	Description
[Ao1] terminal output selection	[Cd-04]	Parameter number for "12.25.4 Selecting data to be output"	Sets a parameter number.
[Ao2] terminal output selection	[Cd-05]		
Analog monitor adjustment mode selection	[Cd-10]	00	Invalid.
		01	Valid. Outputs to terminals output levels in the adjustment mode.
[Ao1] output filter time constant	[Cd-21]	1~500[ms]	Filters and outputs the selected data.
[Ao1] output data type selection	[Cd-22]	00	Outputs the absolute value of data.
		01	Outputs data with a symbol as is.
[Ao1] bias adjustment (Common to voltage/current)	[Cd-23]	-100.0~100.0[%]	Biases data to adjust Point 0 of data.
[Ao1] gain adjustment (Common to voltage/current)	[Cd-24]	-1000.0~1000.0[%]	Apply a gain to data to adjust an inclination in data.
[Ao1] output level in the adjustment mode	[Cd-25]	-100.0~100.0[%]	Sets output in the adjustment mode. It selects the maximum output (at 100.0%), the minimum output (at 0.0%) ([Cd-22]=00), or the minimum output (at -100.0%) ([Cd-22]=01).
[Ao2] output filter time constant	[Cd-31]	1~500[ms]	Filters and outputs the selected data.
[Ao2] output data type selection	[Cd-32]	00	Outputs the absolute value of data.
		01	Outputs data with a symbol as is.
[Ao2] bias adjustment (Common to voltage/current)	[Cd-33]	-100.0~100.0[%]	Biases data to adjust Point 0 of data.
[Ao2] gain adjustment (Common to voltage/current)	[Cd-34]	-1000.0~1000.0[%]	Apply a gain to data to adjust an inclination in data.
[Ao2] output level in the adjustment mode	[Cd-35]	-100.0~100.0[%]	Sets output in the adjustment mode. It selects the maximum output (at 100.0%), the minimum output (at 0.0%) ([Cd-32]=00), or the minimum output (at -100.0%) ([Cd-32]=01).

■ Bias adjustment of analog output

Terminal	Current/voltage	Bias parameter
Ao1	Common to voltage/current	[Cd-23]
Ao2	Common to voltage/current	[Cd-33]

- You can bias Point 0 as shown in the below figure.

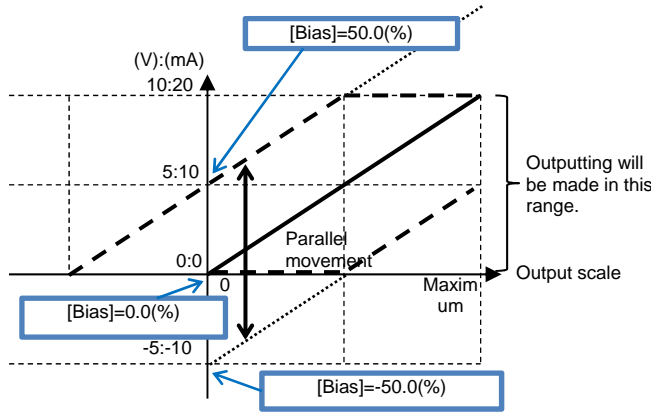

(Example) Outputting information on the "[dA-01] output frequency monitor" to [Ao1] in a voltage range from 0 to 10 V

- I want to perform outputting in a range from 0 Hz to the maximum frequency (60 Hz).  
[Cd-23]=0.0%, [Cd-24]=100.0%

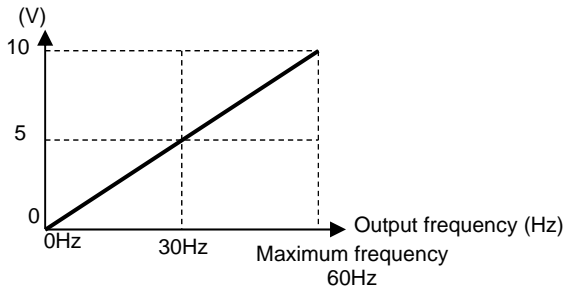

(Example) Outputting information on the output frequency monitor to [Ao1] in a current range from 4 to 20 mA

- I want to perform outputting in a range from 0 Hz to the maximum frequency (50Hz).  
[Cd-23]=20.0%, [Cd-24]=80.0%

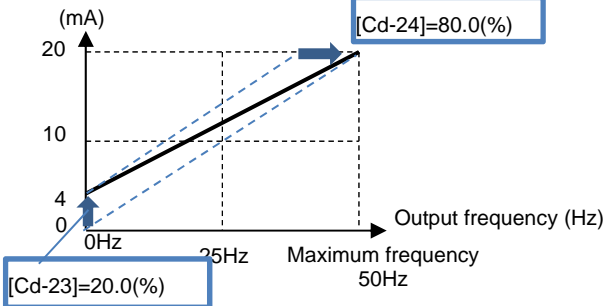

■ Gain adjustment of analog output

Terminal	Current/voltage	Gain parameter
Ao1	Common to voltage/current	[Cd-24]
Ao2	Common to voltage/current	[Cd-34]

- You can change an inclination as shown in the below figure.

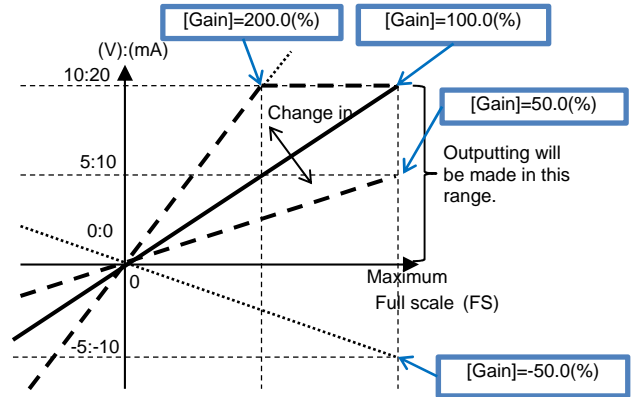

(Example) Outputting information on the output current monitor to [Ao2] in a current range from 4 to 20 mA

- I want to monitor the current in a range from 0 A to the inverter rated current.  
[Cd-33]=20.0%, [Cd-34]=160.0%

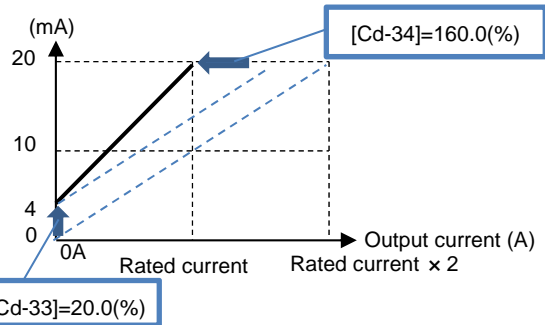

(Example) Outputting information on the output torque monitor to [Ao2] in a voltage range from 0 to 10 V

- I want to apply a voltage output range from 0 to 10 V in a torque range from -200 to 200%.  
[Cd-32]=01, [Cd-33]=50.0%, [Cd-34]=50.0%

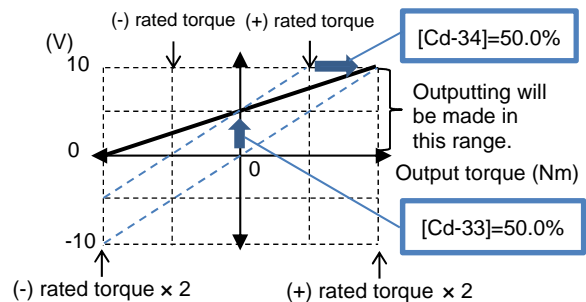

\*) When [Cd-32]=00 is set in the above described example, corresponding values in a range from 5 to 10 V will be output for a range from 0 to -200% on the "(-) rated torque" side.

■ Analog monitor adjustment mode: [Ao1] and [Ao2] output

- Setting the analog monitor adjustment mode [Cd-10] to 01 fixes the outputs of the [Ao1] and [Ao2] output terminals.

- With the output fixed with [Ao1], an output set with [Cd-25] is made for the full-scale value of the monitor selected with [Cd-04].
- With the output fixed with [Ao2], an output set with [Cd-35] is made for the full-scale value of the monitor selected with [Cd-05].

(Example) Outputting from [Ao1] information on the output current monitor in a range from 4 to 20 mA

- I want to perform outputting in a range from 4 to 20 mA when a current ranging from 0 A to a current value of Inverter rated current  $\times 2$  flows.

(The standard points are a current in a range from 0 A to a current value of Inverter rated current  $\times 2$ )

Code	Name	Output scale range (Corresponding to 0 to 10 V / 0 to 20 mA)
dA-02	Output current monitor	(0.00 to 2.00) $\times$ Inverter rated current (A)

**1** Check that [SW3] on the substrate is set to a current of 20 mA, and then turn on the power supply.

Set [Cd-04]=[dA-02]. Setting [Cd-10] to 01 and [Cd-25] to 0.0% sets the output from the [Ao1] terminal to 0 mA.

**2** When the standard point you want to output is 0 A, and when you want to output 4 mA from [Ao1], adjust [Cd-23] to approximately 20.0%, and check if 4 mA is output.

(For example, see and wait with a range from 15.0% to 25.0%.)

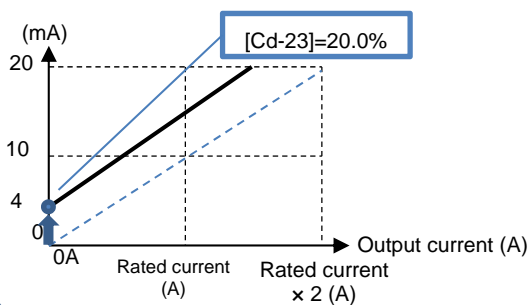

**3** Setting [Cd-25] to 100.0% sets the output from the [Ao2] terminal to approximately 20 mA.

**4** Adjust the inclination with [Cd-24]. Change [Cd-24] to make an adjustment immediately before the point at which [Ao2] begins lowering from 20 mA.

(For example, see and wait with a range from 75.0 to 85.0%.)

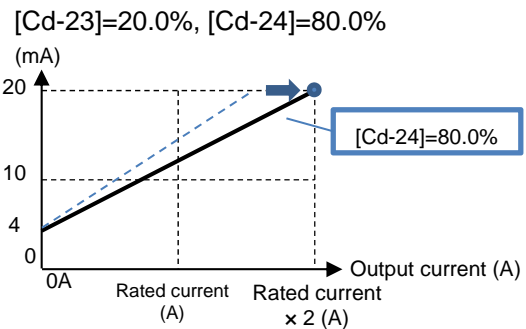

**4** Returning [Cd-10] to 00 starts current output of [Ao1] that is adjusted.

# 13





## Chapter 13 Information Monitor Functions

Contents

- 13.1 What This Chapter Explains ..... 13-1
- 13.2 Checking the Frequency Data ..... 13-2
  - 13.2.1 Monitoring output frequency ..... 13-2
  - 13.2.2 Monitoring frequency command ..... 13-3
  - 13.2.3 Monitoring converted frequency ..... 13-4
  - 13.2.4 Monitoring the motor detection speed ..... 13-5
- 13.3 Checking the Acceleration Time or Deceleration Time ..... 13-6
  - 13.3.1 Monitoring the acceleration time or deceleration time ..... 13-6
- 13.4 Checking the Rotational Direction ..... 13-7
  - 13.4.1 Monitoring the rotational direction..... 13-7
- 13.5 Checking the Input or Output of Terminals ..... 13-8
  - 13.5.1 Checking the input of input terminals..... 13-8
  - 13.5.2 Checking the output of output terminals ..... 13-8
- 13.6 Monitoring Output Currents ..... 13-9
- 13.7 Monitoring Output Voltage ..... 13-10
- 13.8 Checking P-N Voltage (Internal DC Voltage) ..... 13-10
- 13.9 Checking the Inverter’s Operating Time and Operation Count..... 13-11
  - 13.9.1 Checking the cumulative operating hours.... 13-11
  - 13.9.2 Checking the cumulative power-on time..... 13-11
  - 13.9.3 Checking the total start-up count ..... 13-12
  - 13.9.4 Checking the total start-up count ..... 13-12
- 13.10 Checking the Inverter Temperature ..... 13-13
  - 13.10.1 Checking the cooling fin temperature ..... 13-13
- 13.11 Checking the Inverter Power Consumption..... 13-14
  - 13.11.1 Checking the input power ..... 13-14
  - 13.11.2 Checking the output power ..... 13-15
- 13.12 Checking the Result of Life Diagnosis ..... 13-16
  - 13.12.1 Checking the life monitor ..... 13-16
  - 13.12.2 Checking the cumulative operating time of cooling fan..... 13-17
- 13.13 Checking Electric Thermal Load Ratio ..... 13-18
  - 13.13.1 Checking thermal load ratio of the motor... 13-18
  - 13.13.2 Checking thermal load ratio of the inverter 13-18
- 13.14 Checking Load Ratio of Braking Resistor ..... 13-19
- 13.15 Checking the State of Option Slot Mounted..... 13-20
- 13.16 Checking the State of Analog Switch ..... 13-21
- 13.17 Checking the Load type of Inverter ..... 13-22
- 13.18 Checking the Rated Current of Inverter ..... 13-22
- 13.19 Checking the Operation and Frequency Command Destinations ..... 13-23
- 13.20 Checking the State of Inverter ..... 13-24
  - 13.20.1 Iconized monitors ..... 13-24
- 13.21 Monitoring Analog Input Information ..... 13-26
- 13.22 Monitoring Terminal Block Mounting Status..... 13-27
- Functions Described in Other Chapters..... 13-28

### 13.1 What This Chapter Explains

This chapter describes various monitor functions of the inverter. Select a monitor function that you want to use and configure it.  
 Make sure to carefully read “Chapter 1 Safety Instructions/Risks” for safety work.

Symbol	Meanings
	General and troubleshooting questions
	Key points for a solution
	Notes
	Confirmation of procedures



## 13.2 Checking the Frequency Data

### 13.2.1 Monitoring output frequency

**Q**

- Want to check output frequency (frequency).

**A**

- Output frequency operates in such a way that the inverter starts running and follows the frequency command according to the setting of the acceleration/deceleration time.

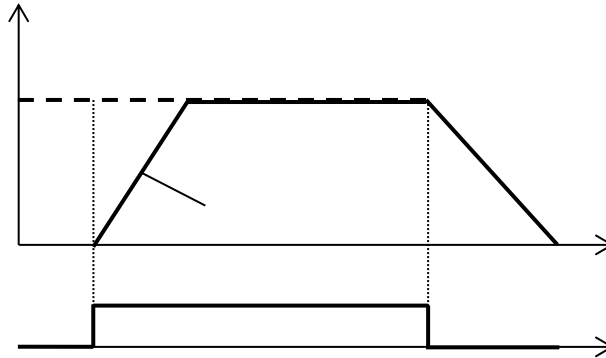

#### Parameter

Item	Parameter	Data	Description
Output frequency monitor	[dA-01]	0.00~590.00 (Hz)	Displays output frequency.
Frequency command	[dA-04]	-590.00~590.00 (Hz)	Displays frequency command.
Output frequency monitor	[dA-12]	-590.00~590.00 (Hz)	Displays output frequency with sign. A forward revolution is indicated with + sign, and a reverse revolution with -.

### 13.2.2 Monitoring frequency command

#### Q

- Want to check the frequency command which is entered currently.
- Want to check the main speed and auxiliary speed individually.

#### A

- Frequency command [dA-04] monitors the state of command which is input ultimately at the moment.
- As for the main speed command monitor [FA-01], frequency command setting value can be changed by using UP/DOWN keys on the monitor, if the main speed command selection [AA101] is set to 07 (Operator keypad setting).
- As for the auxiliary speed command monitor [FA-02], frequency command setting value can be changed by using UP/DOWN keys on the monitor, if the auxiliary speed command selection [AA102] is set to 07 (Operator keypad setting).

#### !

- If the frequency command monitor does not change when frequency command is changed, a command destination not intended by the frequency command may have taken a priority.
- The frequency command is influenced by the following functions:
  - Main speed command selection [AA101]
  - Auxiliary speed command selection [AA102]
  - Jogging command [JG]
  - Multi-speed command [CF/SF]
  - Operation switching [SCHG]
  - Frequency operator [AA105]
  - Forced operation [F-OP]
  - Addition [ADD]
- See “12.4 Select a frequency command.” for details.

#### Parameter

Item	Parameter	Data	Description
Frequency command	[dA-04]	-590.00~590.00 (Hz)	Displays frequency command. Displays a result of function such as jogging, multi speed, and forced operation.
Main speed command monitor	[FA-01]	0.00~590.00 (Hz)	Displays the command frequency selected for the main speed command [AA101].
Auxiliary speed command monitor	[FA-02]	Monitor: 0.00 to 590.00 (Hz) Setting: -590.00 to 590.00 (Hz)	Displays the command frequency selected for the auxiliary speed command [AA102].

**13.2.3** Monitoring converted frequency



- Want to change the displayed frequency command value.



- On the frequency conversion monitor, the frequency value obtained by multiplying the coefficient which is set in the frequency conversion coefficient [Ab-01] can be shown. Use this method when you want to change the displayed value of data such as motor rotation speed, etc.
- Example of conversion of displayed frequency  
 “Value displayed on frequency conversion monitor [dA-06]” = “Frequency command (Hz)” x  
 “ Frequency conversion coefficient [Ab-01]”

(Example) Displaying the motor rotation speed  
 The relationship of rotation speed and frequency is as shown below:  
 Rotation speed  $N$  ( $\text{min}^{-1}$ ) =  $(120 \times f \text{ (Hz)})/P$  (poles)  
 When the motor frequency is 60Hz and the number of poles is 4, the coefficient is 30; hence at 60Hz, where [Ab-01]=30.00, “ $60 \times 30.0 = 1800$  ( $\text{min}^{-1}$ )” will be displayed on the monitor.



- In this monitor, gain is applied to the output frequency monitor [dA-01].

Table of sample conversions

Motor frequency (Hz)	Number of motor poles (P)	Coefficient [Ab-01]	Synchronous rotation [min-1]
50	2	60	3000
50	4	30	1500
50	6	15	750
50	8	7.5	375
60	2	60	3600
60	4	30	1800
60	6	15	900
60	8	7.5	450

■ Parameter

Item	Parameter	Data	Description
Frequency conversion monitor	[dA-06]	0.00~59000.00 (Hz)	Converted output frequency is displayed.
Frequency conversion coefficient	[Ab-01]	0.01~100.00	Set the gain of frequency conversion monitor.

### 13.2.4 Monitoring the motor detection speed

**Q**

- Want to see the rotation frequency information fed back from the motor.

**A**

- If the motor is controlled with the feedback option, the feedback rotation speed data can be shown as frequency.

**!**

- Frequency will not be displayed if the feedback function is not used.
- Frequency will not be correctly displayed if the number of pulses of encoder and the number of motor poles are not set accurately.

#### Parameter

Item	Parameter	Data	Description
Speed detection value monitor	[dA-08]	-590.00~590.00 (Hz)	Displays the feedback speed detection value.
Encoder constant set-up	[CA-81]	32~65535 (pls)	Enabled when the “pulse train input (inverter) detection target [CA-90]” is set to other than 00.
Pulse train input (inverter) detection target selection	[CA-90]	00	Pulse count (PCNT) function is enabled.
		01	Pulse train input frequency command is enabled.
		02	Speed feedback
		03	Pulse count
Encoder constant set-up (P1-FB)	[ob-01]	32~65535 (pls)	Set the number of pulses of encoder which is input from P1-FB. It is enabled when [CA-90] is set to 00.
Selection of number of motor poles	[Hb103]	2 to 48 (poles)	Set the number of motor poles.

### 13.3 Checking the Acceleration Time or Deceleration Time

#### 13.3.1 Monitoring the acceleration time or deceleration time



- Want to check the acceleration or deceleration time of the inverter.



- The time of acceleration or deceleration currently underway can be shown, when, with 2-step acceleration/deceleration function or multi-speed function, the acceleration or deceleration time is switched or when you are using the inverter while changing the acceleration/deceleration time setting.
- The time that it takes to rise from 0 Hz to the maximum frequency will be displayed as the acceleration time.
- The time that it takes to fall from the maximum frequency to 0 Hz will be displayed as the deceleration time.



- The acceleration time and deceleration time monitors are affected by the following functions:
  - Acceleration/deceleration function
  - 2-step acceleration/deceleration function
  - Multi-speed function
  - PID soft-start function
  - Acceleration/deceleration cancellation [LAC] function
  - Second setting [SET] function
- The acceleration time and deceleration time monitors are enabled only under the frequency control. A correct value may not be displayed when the acceleration or deceleration time fluctuates depending on the torque under the torque control.
- When the frequency is accelerated or decelerated after the acceleration or deceleration pattern is changed, the time to change between 0 Hz and maximum value will be displayed.

#### Parameter

Item	Parameter	Data	Description
Acceleration time monitor	[FA-10]	0.00~3600.00 (s)	Monitors the enabled acceleration time.
Deceleration time monitor	[FA-12]	0.00~3600.00 (s)	Monitors the enabled deceleration time.

## 13.4 Checking the Rotational Direction

### 13.4.1 Monitoring the rotational direction



- Want to check the rotational direction currently used.



- The rotational direction is determined by methods of operation command and signs of frequency command.



- In the zero-speed output mode, it is likely that the converter is outputting under 0Hz command due to the direct current function, forcing function, or 0Hz range sensorless vector control, etc.
- The inverter is stopped when an output is not made.

#### ■ Parameter

Item	Parameter	Data	Description
Operation direction monitor	[dA-03]	00: Stop	Inverter is stopped.
		01: Zero-speed out	Inverter is outputting 0 Hz.
		02: Forward run	Inverter is running under forward rotation command.
		03: Reverse run	Inverter is running under reverse rotation command.

### 13.5 Checking the Input or Output of Terminals

#### 13.5.1 Checking the input of input terminals



- Want to know the status of commands currently entered to the input terminals.
- Want to check whether input terminals are disconnected or not.



- If the monitor status doesn't change when a terminal is turned ON and OFF, the input wires may be disconnected.
- When the [RS] terminal is turned ON, the inverter enters a reset mode; hence the state of input terminal cannot be checked on the input terminal monitor. However, from the fact the inverter enters the reset mode, you know that the terminal is working.



- The input terminal monitor displays the physical ON (H)/OFF (L) status of terminals.
- A reaction of the input terminal monitor delays according to input terminal response time.
- The input terminal monitor is not affected by setting of a/b contact.

(Example) The state where terminals 4 and 8 are ON.

Monitor	L L L H L L L H L L
Terminal No.	(B) (A) (9) (8) (7) (6) (5) (4) (3) (2) (1)

■Parameter

Item	Parameter	Data	Description
Input terminal monitor	[dA-51]	LLLLLLLLLLL~HHHHHHHHHH	Displays the ON/OFF status of input terminals (H: ON; L: OFF).

#### 13.5.2 Checking the output of output terminals



- Want to know the status of commands to the output terminals which are outputting now.
- Want to check whether output terminals are disconnected or not.



- If the output terminal status doesn't change when the monitor status changes, the output wires may be disconnected.
- The output terminal monitor is not affected by setting of a/b contact.



- The output terminal monitor displays the state of internal functions.
- The output terminal monitor behaves as set for on-delay/off-delay of output terminals.

(Example) The state where terminals 15 and AL are ON.

Monitor	H L H L L L L
Terminal No.	(AL) (16) (15) (14) (13) (12) (11)

■Parameter

Item	Parameter	Data	Description
Output terminal monitor	[dA-54]	LLLLLL~HHHHHH	Displays the ON/OFF status of output terminals (H: ON; L: OFF).

## 13.6 Monitoring Output Currents



- Want to check the effective value of current flowing in the motor.
- Want to see the movement of output currents



- The lower the carrier frequency, the more the value of current of monitor may fluctuate, depending on the PWM output system of the inverter.



- Displays the output current flowing in the motor.

### ■ Parameter

Item	Parameter	Data	Description
Output current monitor	[dA-02]	0.00~655.35 (A)	Displays the effective value of output current flowing in the motor.



### 13.7 Monitoring Output Voltage



- Want to check the voltage which is output to the motor.
- Want to see the movement of output voltage.



- A correct value may not be displayed when the input voltage is low.



- Displays the output voltage which is output to the motor.

#### ■ Parameter

Item	Parameter	Data	Description
Output voltage monitor	[dA-18]	0.0~800.0 (V)	Displays the voltage which is output to the motor.

### 13.8 Checking P-N Voltage (Internal DC Voltage)



- Want to see the movement of inverter's internal power supply.
- Want to monitor the power supply when it returns from the motor.



- P-N voltage is DC voltage. The overvoltage error [E007] is generated when P-N voltage exceeds approx. 405Vdc in the case of 200V class inverters, and if P-N voltage exceeds approx. 810Vdc in the case of 400V class inverters.



- P-N voltage charged in the main circuit capacitor of inverter can be monitored.

#### ■ Parameter

Item	Parameter	Data	Description
DC voltage monitor	[dA-40]	0.0~1000.0 (V)	Displays the P-N voltage of inverter.

## 13.9 Checking the Inverter's Operating Time and Operation Count

### 13.9.1 Checking the cumulative operating hours



- Want to check how long the inverter has been operated.



- The cumulative operating hours monitor during RUN cannot be cleared by initialization or the similar method.



- The cumulative operating hours monitor monitors the duration of time that the inverter outputs when a command is input to the inverter.

#### ■ Parameter

Item	Parameter	Data	Description
Cumulative operating hours monitor during RUN	[dC-22]	0~100000 [hr]	Data of period that the inverter outputs is stored for monitoring.

### 13.9.2 Checking the cumulative power-on time



- Want to check the number of hours that the inverter has been ON.



- The cumulative power-on time monitor cannot be cleared by initialization or the like.



- The cumulative power-on time monitor monitors the duration of time that the inverter has been ON.

#### ■ Parameter

Item	Parameter	Data	Description
Cumulative power-on time monitor	[dC-24]	0~100000 [hr]	Data of period that the inverter is ON is stored for monitoring.

**13.9.3** Checking the total start-up count



- Want to check how many times the inverter repeated an operation and stop.



- Total start-up count monitor cannot be cleared by initialization or the like.



- The total start-up count monitor monitors the number of times the inverter started outputting from a condition it was stopped.

■ Parameter

Item	Parameter	Data	Description
Total start-up count monitor	[dC-20]	0 - 65535 (Counts)	Checks the number of times the inverter entered an operation condition from an power-off condition.

**13.9.4** Checking the total start-up count



- Want to check the number of times the inverter was turned ON.



- Power-on count monitor cannot be cleared by initialization or the like.
- Retry restarts due to instantaneous power failures are not counted.



- The cumulative power-on time monitor monitors the number of times the inverter was turned ON.

■ Parameter

Item	Parameter	Data	Description
Cumulative power-on count monitor	[dC-21]	0 - 65535 (Counts)	Checks the number of times the power supply for control circuit was turned ON.

## 13.10 Checking the Inverter Temperature

### 13.10.1 Checking the cooling fin temperature



- Want to know the temperature of inverter's cooling fin.



- The temperature error [E021] is generated when the cooling fin temperature exceeds 120°C.



- Cooling fin temperature monitor monitors the temperature of inverter's fin.

#### Parameter

Item	Parameter	Data	Description
Cooling fin temperature monitor	[dC-15]	-20.0 ~ 200.0 (°C)	Displays the cooling fin temperature

## 13.11 Checking the Inverter Power Consumption

### 13.11.1 Checking the input power



- Want to know the input power to the inverter.
- Want to know the integrated input power of inverter.



- On the input power monitor [dA-30], the power which is currently input to the inverter can be monitored.
- On the integrated input power monitor [dA-32], the integrated data of input power to the inverter can be monitored.



- In the integrated input power display gain [UA-13] mode, the displayed contents can be converted with gain.  
[dA-32]= "Calculated input power value (kWh)"/[UA-13]  
([UA-13] can be set from 1. to 1000. by an unit.)
- By setting the clearing of integrated input power [UA-12] to "01" and then determining it, you can clear an integrated power value.
- Also, if 039 [KHC] (clearing of integrated power) has been assigned to one the input terminals, integrated input power value can be cleared via that terminal.

#### Parameter

Item	Parameter	Data	Description
Input power monitor	[dA-30]	0.00~600.00 (kW)	Displays the input power. Changes according to input power factors.
Integrated input power monitor	[dA-32]	0.0~100000.0 (kWh)	Displays the integrated value of input power. Changes according to input power factors.
Clearing of integrated input power	[UA-12]	00	Disable
		01	Clear
Integrated input power display gain	[UA-13]	1~1000	Displays a value obtained by multiplying by gain.
Input terminal function	[CA-01]~ [CA-11]	039	[KHC] Input power clearance terminal

## 13.11.2 Checking the output power

## Q

- Want to know the output power to the motor.
- Want to know the integrated output power to the motor.

## A

- On the output power monitor [dA-34], the power which is currently being output to the motor can be monitored.
- On the integrated output power monitor [dA-36], the integrated data of output power to the motor can be monitored.

## !

- In the integrated output power display gain [UA-15] mode, the displayed contents can be converted with gain.  
Value indicated on [dA-36] = "Calculated output power value (kWh)"/[UA-15]  
([UA-15] can be set from 1. to 1000. by an unit.)
- By setting the clearing of integrated output power [UA-14] to "01" and then determining it, you can clear an integrated power value.
- Also, if 40 (OKHC: clearing of integrated output power) has been assigned to one of the input terminals, integrated input power value can be cleared via that terminal.

## ■ Parameter

Item	Parameter	Data	Description
Output power monitor	[dA-34]	0.00~600.00 (kW)	Displays the output power.
Integrated output power monitor	[dA-36]	0.0~100000.0 (kWh)	Displays the integrated value of output power.
Clearing of integrated output power	[UA-14]	00	Disable
		01	Clear
Integrated output power display gain	[UA-15]	1~1000	Displays a value obtained by multiplying by gain.
Input terminal function	[CA-01]~ [CA-11]	040	Output power clearance terminal

## 13.12 Checking the Result of Life

### Diagnosis

#### 13.12.1 Checking the life monitor

**Q**

- Want to check the life of Inverter.
- Want to know the timing to be maintained.

**A**

- The life diagnostic monitor monitors the status of following two items.
  - 1: The lives of capacitors on the main circuit board
  - 2: Reduced rotation speed of the cooling fan.
- As for signals, a capacitor life prewarning signal (029 [WAC]) and a fan life advance notice signal (030 [WAF]) can be output.

**!**

- The lives of capacitors are calculated once a ten minutes. If the power supply is repeatedly turned ON and OFF faster than this cycle, the inverter will be incapable of diagnosing the lives of capacitors normally.
- If the selection of the cooling fan operation is set to other than 00, the fan will stop automatically depending on the condition. The life diagnosis isn't carried out while the fan is in the automatic stop mode.

#### Parameter

Item	Parameter	Data	Description
Life diagnostic monitor	[dC-16]	LL~HH	The monitors shows H at the end of the life spans. The monitor on the right indicates the lives of the capacitors on the circuit board, whereas that on the left indicates the life of the cooling fan.
Capacitor life advance notice	[CC-01]~[CC-07]	029	[WAC]: This signal is output when the lives of the capacitors on the circuit board are neared.
Fan life advance notice	[CC-01]~[CC-07]	030	[WAF]: This signal is output when the cooling fan rotation speed is decreased.
Selection of the cooling fan operation	[bA-70]	00	Always ON
		01	The fan is turned ON during operation and continues rotating after the operation is stopped.
		02	Running depending on the temperature. The fan runs as the fin temperature rises.

**A**

- For operation of cooling fan, see "12.18 Controlling the Cooling Fan of the Inverter".

### 13.12.2 Checking the cumulative operating time of cooling fan



- Want to know the operating time of cooling fan



- The cooling fan life monitor can be cleared by setting the parameter.



- The cumulative cooling fan operating time monitor checks the time the cooling fan have operated.
- The cumulative cooling fan operating time monitor can be used as a guild for a replacement of the cooling fan.

#### Parameter

Item	Parameter	Data	Description
Cooling fan life monitor	[dC-26]	0~1000000 (hr)	Measures and displays the duration of time that the cooling fan has been operated.
Selection of cumulative cooling fan operating time clearance	[bA-71]	00	Not carries out.
		01	Carries out clearance at the set time.



### 13.13 Checking Electric Thermal Load Ratio

#### 13.13.1 Checking thermal load ratio of the motor



- Want to check the state of overheat protection of the motor.



- Display the electric thermal load ratio of the motor. The overload protection error [E005] is generated when the displayed thermal load ratio is about to exceed 100%.



- Appropriately perform the basic settings of motor and electric thermal function settings.

#### Parameter

Item	Parameter	Data	Description
Electronic thermal load ratio monitor (motor)	[dA-42]	0.00~100.00 (%)	Displays the thermal load ratio of the motor.

#### 13.13.2 Checking thermal load ratio of the inverter



- Want to check the state of overheat protection of the inverter.



- Display the electric thermal load ratio of the controller (inverter). The controller overload protection error [E038] is generated when the displayed thermal load ratio is about to exceed 100%.



- The heat characteristics of the inverter has been predetermined.

#### Parameter

Item	Parameter	Data	Description
Electronic thermal load ratio monitor (controller)	[dA-43]	0.00~100.00 (%)	Displays the thermal load ratio of the inverter.

### 13.14 Checking Load Ratio of Braking Resistor



- Want to check the use rate of an optional braking resistor.



- Display the use rate of braking resistor circuit (BRD).



- A setting is required for a braking resistor circuit (BRD) to operate. For details, see “12.13.5 Suppressing overvoltage with braking resistor”.
- The braking resistor overload error [E006] is generated when the displayed use rate is about to exceed the value which has been set in the BDR use rate [bA-60].

#### Parameter

Item	Parameter	Data	Description
Braking resistor (BRD) load ratio monitor	[dA-41]	0.00~100.00 (%)	Displays the load ratio of braking resistor.
Braking resistor circuit (BRD) use rate	[bA-60]	0.0~100.0 (%)	Sets the maximum use rate of braking resistor.

## 13.15 Checking the State of Mounted Option Slot



- Want to check whether an optional cassette is properly mounted.
- Want to check whether an optional cassette is recognized.



- On the monitor, you can check which optional cassette is mounted and where it is mounted.



- Recognition of an optional cassette is performed in the condition the power supply of the optional cassette has been established.
- If the optional cassette is poorly connected or damaged, it is regarded as in unconnected state.

### Parameter

Item	Parameter	Data	Description
Option slot 1 mounted	[dA-81]	*) Option ID	Displays the ID of optional cassette mounted in the option slot 1.
Option slot 2 mounted	[dA-82]	*) Option ID	Displays the ID of optional cassette mounted in the option slot 2.
Option slot 3 mounted	[dA-83]	*) Option ID	Displays the ID of optional cassette mounted in the option slot 3.

### Option ID

ID	Cassette option type	Description
00	No	
01	P1-EN	Ethernet communication
02	P1-ECT	EtherCAT communication
33	P1-FB	Line driver feedback

### 13.16 Checking the State of Analog Switch



- Want to check the state of analog voltage/current changeover switches.
- Want to check whether analog input/output terminals are voltage input/output terminals or current input/out terminals.



- You can check the state of analog input/output changeover switches.



- Note that the data cannot be obtained appropriately if the analog input switch selection differs from the actual input, which results in a damage.
- The data cannot be output appropriately if an analog output switch selection differs from the actual output.
- If the data on analog switch monitor does not switch after the switch is switched, check the switch because the switch may not be fully switched or may be damaged.

(Example) For terminals on the inverter, current is enabled only at [Ai2], and voltage is enabled at the other terminals.

For options, current terminal is enabled only at [li4] of [Ai4], and other voltage terminals are enabled.

Monitor	V	V	A	V	V	V	A	V
Terminal No.	(Ao4)	(Ao3)	(Ai4)	(Ai3)	(Ao2)	(Ao1)	(Ai2)	(Ai1)

\*) For options, current terminals and voltage terminals are separated. Each terminal is numbered in the order corresponding to "terminal (current terminal/voltage terminal)" as follows: Ao4 (Io4/Vo4), terminal Ao3 (Io3/Vo3), terminal Ai4 (Ii4/Vi4), and terminal Ai3 (Ii3/Vi3).

■ Parameter

Item	Parameter	Data	Description
Analog I/O selection monitor	[dA-60]	VVVVVVVV~ AAAAAAA	Displays whether an analog input/output terminal is a voltage input/output terminal or a current input/out terminal. [Left side] (terminal Ao4 (Io4/Vo4)) (terminal Ao3 (Io3/Vo3)) (terminal Ai4 (Ii4/Vi4)) (terminal Ai3 (Ii3/Vi3)) (terminal Ao2) (terminal Ao1) (terminal Ai2) (terminal Ai1) [Right side] V: voltage/A: current

### 13.17 Checking the Load type of Inverter



- Want to check the present load type selection.



- You can check the adopted load rating of inverter.



- You should also check the rated current and current derating characteristics because they vary depending on load type selections.

#### ■Parameter

Item	Parameter	Data	Description
Monitor for checking selection of inverter load type	[dC-01]	00	VLD: Very low duty
		01	LD: Low duty
		02	ND: Normal duty

### 13.18 Checking the Rated Current of Inverter



- Want to check the present rated current of inverter.



- You can check the adopted rated current of inverter.



- You should also check not only the rated current but also the current derating characteristics because they vary depending on load type selections.

#### ■Parameter

Item	Parameter	Data	Description
Inverter rated current monitor	[dC-02]	0.0~6553.5 [A]	Displays the rated current adopted to the inverter.

### 13.19 Checking the Operation and Frequency Command Destinations



- Want to check that the operation command destinations do not disagree with the contents you have set.
- Want to check that the frequency command destinations do not disagree with the contents you have set.



- Command destinations vary according to the state of terminal functions as well as to the settings. Commands not input from the currently enabled command destinations will be ignored.



- You can check the operation command destinations and the frequency command destinations that are currently enabled.

#### Parameter

Item	Parameter	Data	Description
Main speed command destination monitor	[dC-07]	01~07, 09~34	00 (disabled), 01 (Ai1), 02 (Ai2), 03 (Ai3), 07 (Multistage speed 0[Ab110]/[Ab210]), 08 (auxiliary speed[AA104]/[AA204]), 09 (Multistage speed 1[Ab-11]), 10 (Multistage speed 2[Ab-12]), 11 (Multistage speed 3[Ab-13]), 12 (Multistage speed 4[Ab-14]), 13 (Multistage speed 5[Ab-15]), 14 (Multistage speed 6[Ab-16]), 15 (Multistage speed 7[Ab-17]), 16 (Multistage speed 8[Ab-18]), 17 (Multistage speed 9[Ab-19]), 18 (Multistage speed 10[Ab-20]), 19 (Multistage speed 11[Ab-21]), 20 (Multistage speed 12[Ab-22]), 21 (Multistage speed 13[Ab-23]), 22 (Multistage speed 14[Ab-24]), 23 (Multistage speed 15[Ab-25]), 24 (JG[AG-20]), 25 (RS485), 29 (Pulse array (inverter)), 31 (EzSQ), 32 (PID), 34 (AHD retention speed)
Auxiliary speed command destination monitor	[dC-08]	00~34	
Operation command destination monitor	[dC-10]	00~06	00 ([FW]/[RV] terminal)/01 (3 wire)/02 (RUN key on operator keypad)/03 (RS485 setting)/04 (Option 1)/05 (Option 2)/06 (Option 3)

## 13.20 Checking the State of Inverter

### 13.20.1 Iconized monitors



- The inverter stops and won't operate.
- You want to know the contents of icons.



- Check the current condition of inverter.



- Command destinations vary according to the state of terminal functions as well as to the settings. Commands not input from the currently enabled command destinations will be ignored.

#### Parameter

Item	Parameter	Data	Description
Detailed monitor for icon 2 LIM	[dC-37]	00~06	Refer to "18.5.1 Checking the warning display".
Detailed monitor for icon 2 ALT	[dC-38]	00~04	
Detailed monitor for icon 2 RETRY	[dC-39]	00~02	
Detailed monitor for icon 2 NRDY	[dC-40]	00~05	

## ■ Detailed monitor for icon 2 LIM [dC-37]

Data	Status	Description
01	The overcurrent suppression function is applied due to increased current.	Under overcurrent suppression.
02	The overload limiting function is applied due to increased current.	Under overload limit.
03	The overvoltage suppression function is applied due to increased P-N voltage.	Under overvoltage suppression.
04	The torque limiting function is applied due to increased current.	Under torque limit.
05	The frequency is within the upper/lower limit or jump frequency limit.	Within upper limit. Within lower limit. Within jump frequency limit.
06	The frequency command at below the minimum frequency has been given.	Under minimum frequency limit.
00	A state other than those above.	A state other than those above.

## ■ Detailed monitor for icon 2 ALT [dC-38]

Data	Status	Description
01	Current is increased.	Overload advance notice in effect.
02	The motor thermal load is increased.	Motor thermal advance notice in effect.
03	The inverter thermal load is increased.	Inverter thermal advance notice in effect.
00	A state other than those above.	A state other than those above.

## ■ Detailed monitor for icon 2 RETRY [dC-39]

Data	Status	Description
01	Waiting to retry after a trip.	Retry Standby.
02	Waiting to restart.	Waiting to restart.
00	A state other than those above.	A state other than those above.

## ■ Detailed monitor for icon 2 NRDY [dC-40]

Data	Status	Description
01	Tripped.	A trip has occurred.
02	Power supply abnormality.	Power failure or undervoltage state.
03	Being reset.	Being reset or waiting to cancel reset.
04	STO	STO is enabled.
05	Waiting.	Waiting for inverter's internal circuit or internal condition to be stable.
06	Data inconsistency.	A setting inconsistency exists (warning).
07	Sequence abnormality.	Abnormality during a sequence operation.
08	Free-run.	Free-run is enabled (free-run operation).
09	Forced stop state.	Operation command isn't permitted. Or forced stop is being issued. (Deceleration stop behavior)
00	A state other than those above.	A state other than those above.



## 13.21 Monitoring Analog Input Information



- Want to check how voltage/current of analog input is recognized by the inverter.



- You can monitor the input values for Ai1/Ai2/Ai3 that are currently being input to the inverter's terminal block.
- You can monitor the input values for Ai4/Ai5/Ai6 that are input to the terminal block of an analog extension option.

### Parameter

Item	Parameter	Data	Description
Analog input [Ai1] monitor	[dA-61]	0.00~100.00 (%)	Monitors analog input values. [Ai1][Ai2]: 0~10V/0~20mA [Ai3]: Equivalent to -10 to 10V
Analog input [Ai2] monitor	[dA-62]	0.00~100.00 (%)	
Analog input [Ai3] monitor	[dA-63]	-100.00~100.00 (%)	
Extended analog input [Ai4] monitor	[dA-64]	0.00~100.00 (%)	Monitors analog input values for an analog extension option. [Ai4(Vi4/Ii4)][Ai5(Vi5/Ii5)]: 0~10V/0~20mA [Ai6(Vi6)]: Equivalent to -10 to 10V
Extended analog input [Ai5] monitor	[dA-65]	0.00~100.00 (%)	
Extended analog input [Ai6] monitor	[dA-66]	-100.00~100.00 (%)	

## 13.22 Monitoring Terminal Block

### Mounting Status



- Want to check how a terminal block option is recognized by the inverter.



- You can monitor a terminal block option which is currently mounted to the inverter.

#### ■ Parameter

Item	Parameter	Data	Description
Terminal block option mounting status	[dA-50]	00 (standard)/ 02 (terminal block with round screws)/ 15 (not connected)	Displays terminal block option types.

## Functions Described in Other Chapters

- The information shown below is provided in the pages shown for reference. Please also read the pages.

### ■ Parameter

Parameter	Description	Reference item	Page
See the right column.	Trip history monitor	Troubleshooting	18-3
See the right column.	Retry history monitor		18-4
See the right column.	Warning monitor		18-28
[dA-16]	Torque limit monitor	Operates under a limited torque.	12-11-9
[dA-17]	Output torque monitor		
[dA-18]	Torque bias monitor	Operates by adding torque command.	12-11-12
[dA-15]	Torque command monitor (after calculation)	Carries out torque control.	12-11-15
[dA-17]	Output torque monitor		
[FA-15]	Torque command monitor		
[dA-31]	Motor temperature monitor	Monitoring of motor temperature	12-7-6
[dA-28]	Pulse counter	Checks the number of input pulses.	12-24-13
[dA-70]	Pulse train input monitor (inverter)	Makes command from pulse train input.	12-4-5
[dA-71]	Pulse train input monitor (P1-FB)	Makes command from pulse train input.	12-4-7
[db-01]~[db-23]	Functions associated with EzSQ	Uses the program function EzSQ.	16-6

# 14

## Chapter 14 RS485 Communication

### Contents

- 14.1 What This Chapter Explains..... 14-1
- 14.2 Modbus-RTU ..... 14-2
  - 14.2.1 Communication specification ..... 14-2
  - 14.2.2 Wiring and Connection..... 14-2
  - 14.2.3 Parameters..... 14-5
  - 14.2.4 Communication process ..... 14-6
- 14.3 Message Structure ..... 14-7
  - 14.3.1 Queries and responses ..... 14-7
  - 14.3.2 Slave addresses (communication station numbers)..... 14-7
  - 14.3.3 Function codes ..... 14-8
  - 14.3.4 Data..... 14-8
  - 14.3.5 Error check..... 14-9
  - 14.3.6 Time required for communication..... 14-10
  - 14.3.7 Responses in the normal condition ..... 14-10
  - 14.3.8 Responses in the abnormal condition. 14-10
  - 14.3.9 No response ..... 14-10
- 14.4 Description of Each Function code ..... 14-11
  - 14.4.1 Reading out the state of coil [01h] ..... 14-11
  - 14.4.2 Reading out the content of retention register [03h] ..... 14-12
  - 14.4.3 Writing to coil [05h]..... 14-13
  - 14.4.4 Writing to retention register [06h] ..... 14-14
  - 14.4.5 Loopback test [08h]..... 14-15
  - 14.4.6 Writing to multiple coils [0Fh] ..... 14-16
  - 14.4.7 Writing to multiple registers [10h]..... 14-17
  - 14.4.8 Writing and reading out to multiple registers [17h] ..... 14-18
  - 14.4.9 Exceptional Responses ..... 14-19
  - 14.4.10 Storing a change made to retention register ..... 14-20
- 14.5 EzCOM Function ..... 14-21
  - 14.5.1 What is EzCOM?..... 14-21
  - 14.5.2 EzCOM Settings..... 14-22
  - 14.5.3 EzCOM Operation ..... 14-23
  - 14.5.4 Examples of EzCOM communication . 14-24
- 14.6 Lists of Coils and Communication Registers ..... 14-26
  - 14.6.1 Preclusions at setting registers and coils ..... 14-26
  - 14.6.2 List of coil numbers ..... 14-27
  - 14.6.3 List of retention register numbers ..... 14-28

### 14.1 What This Chapter Explains





This chapter describes the communication methods operable using RS485 communication. PI main units correspond to Modbus-RTU mode in which RS485 is used as the physical layer.

Hitachi's original EzCOM (communication between inverters) function with Modbus protocol is also available.

Select a communication function that you want to use and configure it.

See "RS485 Communication Guide" for details of functions such as message codes, function codes, registers, and coils.

Make sure to carefully read "Chapter 1 Safety Instructions/Risks" for safety work.

Symbol	Meanings
	General and troubleshooting questions
	Key points for a solution
	Notes
	Confirmation of procedures

## 14.2 Modbus-RTU

### 14.2.1 Communication specification

- Modbus-RTU is used as communication method.

Item	Modbus-RTU Mode	Remarks
Transmission speed	2400/4800/9600/19.2k/38.4k/57.6k/76.8k/115.2k bps	Sets using a parameter.
Communication method	Half duplex communication method	
Synchronous mode	Non-synchronous mode	
Transmission code	Binary	
Transmission method	Transmission from a low-order bit	
Applicable interface	RS-485	
Data bit length	8 bits	
Parity	No / Even / Odd	Sets using a parameter.
Stop bit length	1/2 bits	Sets using a parameter.
Start mode	Half side start mode by host side command	
Waiting time	0~1000[ms]	Sets using a parameter.
Connection form	1:N (N=Maximum 32)	Sets using a parameter.
Error check	Overrun / Framing / CRC-16 / Horizontal parity	

### 14.2.2 Wiring and Connection

#### ■ Wiring location

Connect communication lines to the control circuit terminal block.

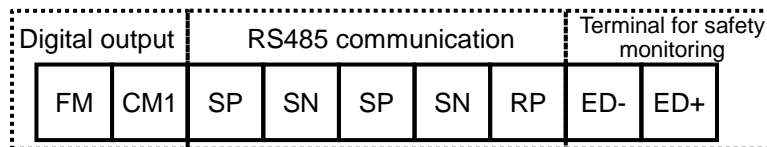

Abbreviated Terminal Name	Description
SP	Sending/receiving + side
SN	Sending/receiving - side
RP	Enable termination resistor terminal
(SN)	Enable termination resistor terminal
(CM1)	Signal ground

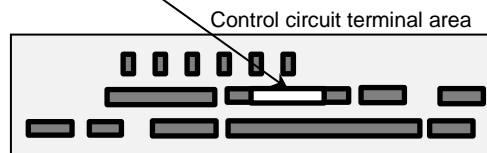

■ Connection

- When performing a connection, connect each inverter in parallel as shown below. For the terminating inverter, short-circuit between terminals RP and SN. (When you execute RS485 communication on one inverter, short-circuit between RP and SN likewise.) With the RP-SN short-circuited, the termination resistor within the control terminal block board becomes enabled, which prevents reflection of signals.

- For communication cables, use shielded cables.
- As for shields, it is recommended that a signal ground (SG) of external control equipment is connected to CM1 of an inverter as shown below.

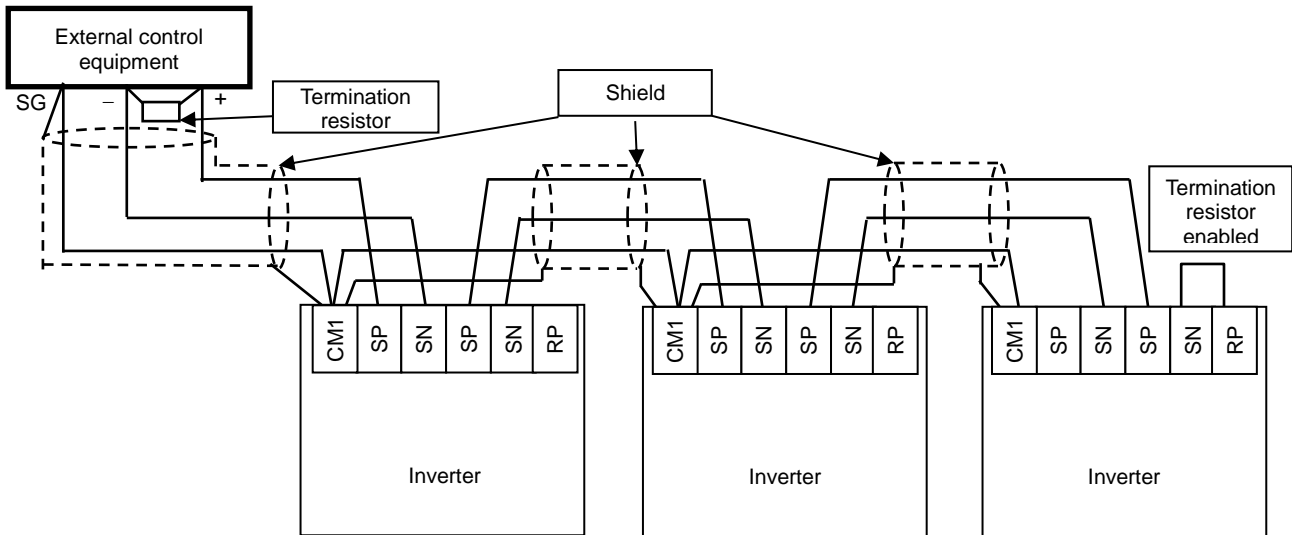

- As for a cable to connect to TM2, use a shielded twisted pair cable (0.5mm<sup>2</sup>). If the above mentioned cable is not available, use the following:

- Single cable of 0.14 mm<sup>2</sup> to 1.5 mm<sup>2</sup> (0.14 mm<sup>2</sup> to 0.5 mm<sup>2</sup> to connect two same size cables to one pole)
- Stranded cable 0.14 mm<sup>2</sup> to 1.0 mm<sup>2</sup> (0.14 mm<sup>2</sup> to 0.2 mm<sup>2</sup> to connect two same size cables to one pole)

- Stranded cable with rod terminal 0.25 mm<sup>2</sup> to 0.5 mm<sup>2</sup> (e.g. 1.25=3AF manufactured by J.S.T. Mfg. Co., Ltd.)

Cable stripping length 5 mm

Tightening torque 0.22·N·m to 0.25·N·m (screw size M2)



- Connect a signal ground (SG) of external control equipment to CM1 of an inverter main body.
- Communication of a shielded cable may be improved by disconnecting the cable from CM1. Change the connection depending on the situation.
- Separate communication cables from power lines and alarm high voltage circuits. Communication cables must not be laid in parallel with power lines and alarm high voltage circuits.
- When using more than a pair of cables, connect all of them to signal wires as shown below. In doing so, connect each pair to SP and SN.

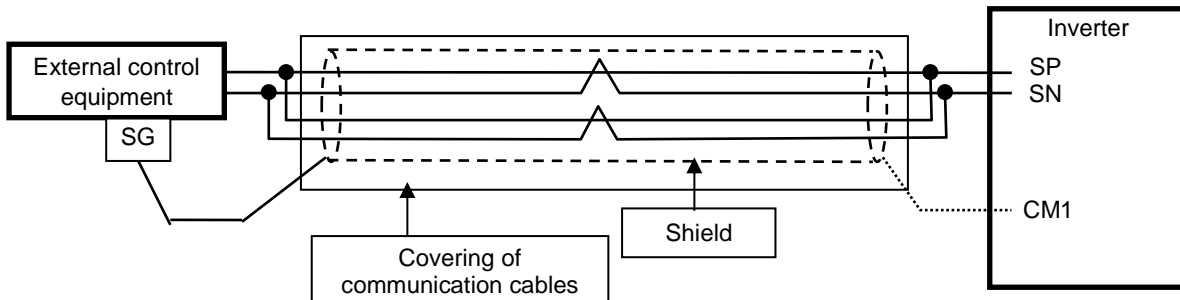

### 14.2.3 Parameters

#### ■ Parameter settings

RS485 communication requires the following settings.

Item	Parameter	Data	Description
Communication transmission speed selection	[CF-01]	03	2400bps
		04	4800bps
		05	9600bps
		06	19200bps
		07	38400bps
		08	57600bps
		09	76800bps
		10	115200bps
Communication station number selection	[CF-02]	1.~247.	Assigns inverter station numbers. This is to be set in controlling multiple inverters simultaneously.
Communication parity selection	[CF-03]	00	No Parity
		01	Even number parity
		02	Odd number parity
Communication stop bit selection	[CF-04]	1	1 bit
		2	2 bits
Communication error selection	[CF-05]	00	Trip
		01	Trips after decelerating and stopping
		02	Ignore
		03	Free-run stop
		04	Deceleration stop
Communication timeout time	[CF-06]	0.00~100.00 (s)	Determination time for communication disconnection. When communication is lost longer than the determination time, the RS485 error [E041] will be generated.
Communication waiting time	[CF-07]	0.~1000. (ms)	The time until the inverter replies.
Communication method selection	[CF-08]	00	Modbus-RTU mode
		01	Communication between inverters (EzCOM)
		02	Communication between inverters (EzCOM administrator)
Output terminal functions and relay output terminal functions	[CC-01]~[C C-07]	049	When a communication disconnection occurs, [NDc] signal is turned ON. As the error is released, the signal will be OFF.



14.2.4 Communication process

**A**

■ Communication process

Communication between external control equipment and the inverter is carried out in the following process:

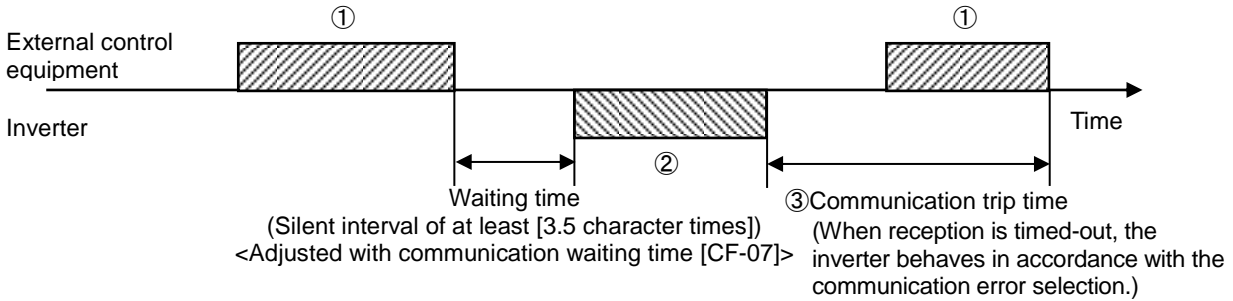

- ① Frame sent from external control equipment to the inverter (query)
- ② Frame returned from the inverter to external control equipment (response)
- ③ After the inverter sends a response, if a query from the host is not completely received within the time set in [CF-06] (communication timeout time), the inverter will be in the condition of receiving the head data again. During this, the inverter will be in a no response condition and will behave as set in the communication error selection. For more details, see the following.

Monitoring of reception timeout begins following the completion of first transmission after the power supply is turned ON or reset. A reception timeout does not occur until a transmission is performed.

A response from the inverter (frame ②) is output as a reply after the inverter receives a query (frame ①) and hence is not output actively.

■ Parameter

Item	Parameter	Data	Description
Communication error selection	[CF-05]	00: Trip	Trip with error [E041] after reception timeout.
		01: Trip after stopping	Deceleration stop after reception timeout. Trip with error [E041] after stopping.
		02: Ignore	No trip, nor alarm output.
		03: Free-run stop	No free-run stop trip, nor alarm output after reception timeout.
		04: Deceleration stop	No deceleration stop, nor alarm output after reception timeout.
Communication timeout time	[CF-06]	0.00~100.00(s)	The time until reception timeout.
Communication waiting time	[CF-07]	0.~1000.(ms)	Waiting time until a reply starts after completion of receiving (excluding silent interval).

### 14.3 Message Structure

#### 14.3.1 Queries and responses

- A command message sent from the master to a slave is called a “query”, and an answering message from a slave is called “response”.

Transmission formats of queries and responses are as shown below:

Query

Slave address
Function code
Query data
Error check (CRC-16)

Response

Slave address for checking
Function code for checking
Answering data
Error check (CRC-16)

#### 14.3.2 Slave addresses (communication station numbers)

- A slave address is a number from 1 to 247 which is set in each inverter (slave) in advance. (Only the inverter having the address matching the query’s slave address will take the query.)
- If you designate “0” to the slave address of transmission destination in the master inverter, you can activate a broadcasting to all stations (simultaneous broadcasting). Under the broadcasting mode, all slaves receive data but do not return responses.
- Under the broadcasting mode, data readout and loopback cannot be executed.
- Although in the Modbus specification, slave addresses from 1 to 247 are used, if you use slave addresses from 250 to 254 on the master side, you can execute a simultaneous broadcasting only to the specific slave addresses. (The slaves do not return responses. This function is valid only for writing commands (05h, 06h, 0Fh, 10h).)

Slave Address	Transmission Destination
250 (Fah)	Simultaneous broadcasting to slave addresses 01 to 09.
251 (FBh)	Simultaneous broadcasting to slave addresses 10 to 19.
252 (FCh)	Simultaneous broadcasting to slave addresses 20 to 29.
253 (FDh)	Simultaneous broadcasting to slave addresses 30 to 39.
254 (FEh)	Simultaneous broadcasting to slave addresses 40 to 247.

**14.3.3** Function codes

- Specify functions the inverter executes using function codes.

Corresponding function codes are shown below:

Function code

Function Code	Function	Max. Data Bytes Handled by 1 Message	Max. Number of Data Handled by 1 Message
01h	Reads out the state of coil.	4	32 coils (bitwise)
03h	Reads out the content of retention register.	32	16 registers (in bytes)
05h	Writes to coil.	2	1 coil (bitwise)
06h	Writes to retention register.	2	1 register (in bytes)
08h	Loopback test	-	-
0Fh	Writes to multiple coils.	4	32 coils (bitwise)
10h	Writes to multiple retention registers.	32	16 registers (in bytes)
17h	Writes / reads out to multiple retention registers.	32 / 32	16 / 16 registers (in bytes)

**14.3.4** Data

- Transmit the data related to function codes.
- The inverter corresponds to the data formats shown below among data used in Modbus.

- Transmission formats of data vary depending on function codes.

Data Name	Description
Coil	Writable/readable binary data (1 bit long)
Retention register	Writable/readable 16 bits long data

14.3.5 Error check

- To check errors in Modbus-RTU, use CRC (Cyclic Redundancy Check).
- To generate a CRC code, use the generating polynomial for CRC-16 ( $X^{16}+X^{15}+X^2+1$ ).

- CRC codes are 16 bits data generated for a block with arbitrary data length in 8-bit unit.

Example of procedure for calculating CRC-16.

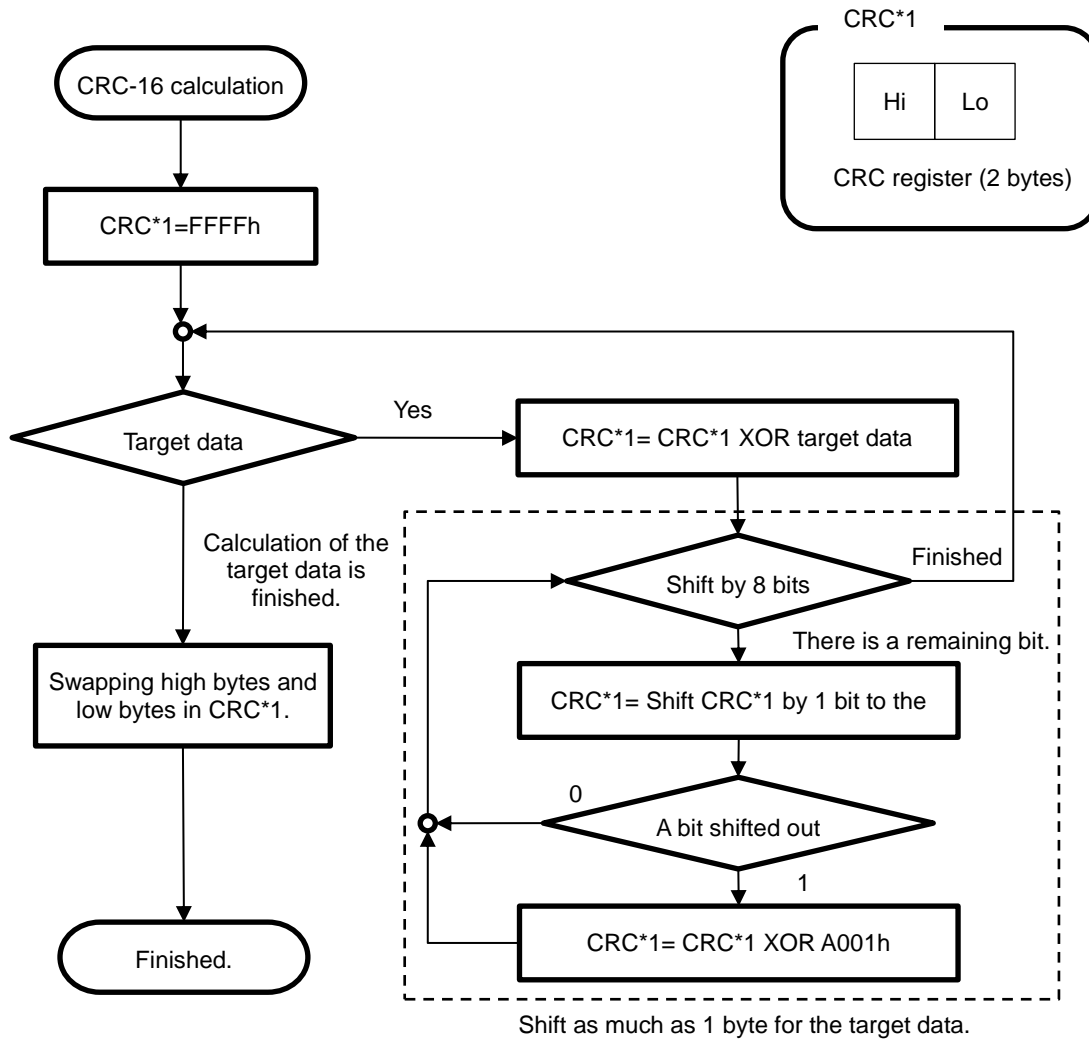

**14.3.6 Time required for communication**

- The inverter's response after it receives a query is equal to [CF-07] (communication waiting time) setting value plus processing time for creating response.

**14.3.7 Responses in the normal condition**

- A response is returned in accordance with the format for each query defined in "3. Description of Each Function code".

**14.3.8 Responses in the abnormal condition**

- When there is a failure (excluding communication error) in the content of a query, the inverter returns an exceptional response without executing any action requested by the query.
- For error determination, check the function code of the response. The function code of the exceptional response is the value obtained by adding 80h to the function code of the query.

**14.3.9 No response**

- The inverter ignores a query and returns no response in the following conditions:
  - (1) A broadcast (query with slave address "0") is received.
  - (2) A communication error is detected during a query reception processing.
  - (3) The query's slave address doesn't match the slave address set in the inverter.
  - (4) The time interval between data constituting a message is 3.5 characters or less.
  - (5) The data of query is in the wrong length.
  - (6) The reception interval within frame exceeds 1.5 character.

- When transmitting the next query to the inverter after receiving a response from the inverter, make sure to provide an interval equal to the silent interval of [at least 3.5 characters] or more.

- Field composition for exceptional response

Slave address
Function code
Exception code
CRC-16

- For more details of errors, see "14.3.9 Exceptional Responses".

- (7) An error check code of query does not match (CRC error).
- (8) A simultaneous broadcasting by group (query with slave address from 250 to 254) is received.



- Provide the master with a timer for monitoring responses, then if a response is not returned within the time, transmit the same query again.

## 14.4 Description of Each Function code

### 14.4.1 Reading out the state of coil [01h]

- Read out the state of coil (ON/OFF).

(Example)

To read out the input terminal functions from 1 to 6 of the inverter with slave address 8, the state of input terminals are as shown in the right table.

Query

	Field Name	Example (HEX)
1	Slave address *1)	08
2	Function code	01
3	Coil starting No. (high) *2)	00
4	Coil starting No. (low) *2)	06
5	Number of coils (high) *3)	00
6	Number of coils (low) *3)	06
7	CRC-16 (high)	5C
8	CRC-16 (low)	90

- Coils 13 and 14 are OFF.

Input terminal No.	1	2	3	4	5	6
Coil No.	7	8	9	10	11	12
Terminal state	ON	ON	ON	OFF	ON	OFF

Response

	Field Name	Example (HEX)
1	Slave address	08
2	Function code	01
3	Data bytes	01
4	Coil data *4)	17
5	CRC-16 (high)	12
6	CRC-16 (low)	1A



- \*1) A broadcasting cannot be executed.
- \*2) Note that the value of starting number is one less than the actual number. Specify the value of "(Coil No.) -1".
- \*3) Where the number of readout coils is specified to value 0 or value exceeding 32, error code "03h" is returned.
- \*4) Data as much as the number of data bytes is transferred.



- Data received as a response indicates the state of coils 7 to 14. The data "17h = 00010111b" received here is read as shown below, letting coil 7 be the LSB.

When the coil state readout command cannot be executed normally, see "3.9 Exceptional Responses".

Coil	14	13	12	11	10	9	8	7
Coil state	OFF	OFF	OFF	ON	OFF	ON	ON	ON
17h	0	0	0	1	0	1	1	1

In the last coil data, if the readout coil data extends to the outside the range of defined coil, the coil data beyond the range is transmitted as "0".

**14.4.2** Reading out the content of retention register [03h]

- Read out the contents of consecutive retention registers as much as specified, from the specified retention register addresses.

(Example)

To read out a past trip history from the inverter with slave address 5.

(To read out the factors and output frequency of trip monitor 1.)

----

	Trip monitor 1 (factor)	Trip monitor 1 (output frequency)
Retention register No.	03E9h	03EAh, 03EBh
Data	Overvoltage (E007) (0007h)	60.00Hz (0000h, 1770h)

Query

Field Name	Example (HEX)
1 Slave address *1)	05
2 Function code	03
3 Register starting No. (high) *2)	03
4 Register starting No. (low) *2)	E8
5 The number of retention registers (high)	00
6 The number of retention registers (low)	03
7 CRC-16 (high)	84
8 CRC-16 (low)	3F

Response

Field Name	Example (HEX)
1 Slave address	05
2 Function code	03
3 Data bytes *3)	06
4 Register starting No. (high)	00
5 Register starting No. (low)	07
6 Register starting No. +1 (high)	00
7 Register starting No. +1 (low)	00
8 Register starting No. +2 (high)	17
9 Register starting No. +2 (low)	70
10 CRC-16 (high)	A8
11 CRC-16 (low)	61



- \*1) A broadcasting cannot be executed.
- \*2) Note that the value of starting number is one less than the actual number. Specify the value of "(Register No.) -1".
- \*3) Data as much as the number of data bytes is transferred. In this example, two retention registers are returned; hence 4 bytes.



- The data received as a response is read as shown below.

Response buffer	4	5	6	7	8	9
Retention register starting No.	+0 (hi)	+0 (lo)	+1 (hi)	+1 (lo)	+2 (hi)	+2 (lo)
Response data	00h	07h	00h	00h	17h	70h
Trip description	Overvoltage trip (0007h)		Trip frequency 60.00Hz (00001770h)			

- When a readout of retention register contents cannot be executed normally, see "3.9 Exceptional Responses".

**14.4.3** Writing to coil [05h]

- Perform writing to a coil.  
Coil states change as shown in the table at the right.

(Example)

To give an operation command to the inverter with slave address 10.

- You need to set the operation command selection [AA111] to 03 in advance to operate using a Modbus command.
- Coil No. for operation command is “1”.

Query

	Field Name	Example (HEX)
1	Slave address *1)	0A
2	Function code	05
3	Coil starting No. (high) *2)	00
4	Coil starting No. (low) *2)	00
5	Data to be changed (high)	FF
6	Data to be changed (low)	00
7	CRC-16 (high)	8D
8	CRC-16 (low)	41

	Coil state	
	OFF→ON	ON→OFF
Data to be changed (high)	FFh	00h
Data to be changed (low)	00h	00h

Response

	Field Name	Example (HEX)
1	Slave address	0A
2	Function code	05
3	Coil starting No. (high)	00
4	Coil starting No. (low)	00
5	Data to be changed (high)	FF
6	Data to be changed (low)	00
7	CRC-16 (high)	8D
8	CRC-16 (low)	41



\*1) When a broadcasting is performed, a response is not returned.

\*2) Note that the shown value is one less than starting number. For coil No. 0001, specify 0000(=0001-1).



- When a writing to a coil cannot be executed normally, see “3.9 Exceptional Responses”.



**14.4.4** Writing to retention register [06h]

- Perform a writing to the specified retention register.

(Example)

To write 50Hz as the 0 speed command [Ab110] to the inverter with slave address 1.

- In order to set 50Hz, set the data to be changed to “5000 (1388h) because the data resolution of retention register “2F4Eh” for 0 speed command [Ab110] is 0.01Hz.

Query

	Field Name	Example (HEX)
1	Slave address *1)	01
2	Function code	06
3	Register starting No. (high)	2F
4	Register starting No. (low)	4D
5	Data to be changed (high)	13
6	Data to be changed (low)	88
7	CRC-16 (high)	1C
8	CRC-16 (low)	5F

Response

	Field Name	Example (HEX)
1	Slave address	01
2	Function code	06
3	Register starting No. (high)	2F
4	Register starting No. (low)	4D
5	Data to be changed (high)	13
6	Data to be changed (low)	88
7	CRC-16 (high)	1C
8	CRC-16 (low)	5F



\*1) When a broadcasting is performed, a response is not returned.

\*3) Note that the starting address of [Ab110] retention register is “2F4Dh”, which is one less than the register No. “2F4Eh”. The value obtained by subtracting one from the register No. is the register address.



• When a writing to a retention register cannot be executed normally, see “3.9 Exceptional Responses”.

### 14.4.5 Loopback test [08h]

- Use this test for a communication check between the master and slaves. For test data, arbitrary values can be used.

(Example)

To perform a loopback test on the inverter with slave address 1.

Query

	Field Name	Example (HEX)
1	Slave address *1)	01
2	Function code	08
3	Diagnostic sub code (high)	00
4	Diagnostic sub code (low)	00
5	Data (high)	Arbitrary
6	Data (low)	Arbitrary
7	CRC-16 (high)	CRC
8	CRC-16 (low)	CRC

Response

	Field Name	Example (HEX)
1	Slave address	01
2	Function code	08
3	Diagnostic sub code (high)	00
4	Diagnostic sub code (low)	00
5	Data (high)	Arbitrary
6	Data (low)	Arbitrary
7	CRC-16 (high)	CRC
8	CRC-16 (low)	CRC



\*1) A broadcasting cannot be executed.



- Diagnostic sub codes correspond to query data echo (00h, 00h) only and not to other commands.

### 14.4.6 Writing to multiple coils [0Fh]

- Rewrite consecutive multiple coils.

(Example)

To change the state of input terminal functions from 1 to 6 of the inverter with slave address 5.

#### Query

Field Name	Example (HEX)
1 Slave address *1)	05
2 Function code	0F
3 Coil starting No. (high) *2)	00
4 Coil starting No. (low) *2)	06
5 Number of coils (high)	00
6 Number of coils (low)	06
7 Bytes *3)	02
8 Data to be changed (high) *3)	17
9 Data to be changed (low) *3)	00
10 CRC-16 (high)	DB
11 CRC-16 (low)	3E



- \*1) When a broadcasting is performed, a response is not returned.
- \*2) Note that the value of starting number is one less than the No.
- \*3) Even when the number of bytes required to be changed is odd, add 1 to the number to make it even because the data to be changed will consist of higher order and lower order bytes as a set.



- When a writing to multiple coils cannot be executed normally, see “3.9 Exceptional Responses”.

The state of input terminals are as shown below.

Input terminal No.	1	2	3	4	5	6
Coil No.	7	8	9	10	11	12
Terminal state	ON	ON	ON	OFF	ON	OFF

#### Response

Field Name	Example (HEX)
1 Slave address	05
2 Function code	0F
3 Coil starting No. (high)	00
4 Coil starting No. (low)	06
5 Number of coils (high)	00
6 Number of coils (low)	06
7 CRC-16 (high)	34
8 CRC-16 (low)	4C

### 14.4.7 Writing to multiple registers [10h]

- Rewrite consecutive multiple registers.

(Example)

To set acceleration time [FA-10] for the inverter with slave address 1 to 3,000 seconds.

- In order to set 3,000 seconds, set the data to be changed to “300,000 (493E0h)” because the data resolution of retention registers “2B02h, 2B03h” for acceleration time [FA-10] is 0.01 seconds.

#### Query

	Field Name	Example (HEX)
1	Slave address *1)	01
2	Function code	10
3	Starting address (high) *2)	2B
4	Starting address (low) *2)	01
5	The number of retention registers (high)	00
6	The number of retention registers (low)	02
7	Bytes *3)	04
8	Data to be changed 1 (high)	00
9	Data to be changed 1 (low)	04
10	Data to be changed 2 (high)	93
11	Data to be changed 2 (low)	E0
12	CRC-16 (high)	9E
13	CRC-16 (low)	9F

#### Response

	Field Name	Example (HEX)
1	Slave address	01
2	Function code	10
3	Starting address (high)	2B
4	Starting address (low)	01
5	The number of retention registers (high)	00
6	The number of retention registers (low)	02
7	CRC-16 (high)	E5
8	CRC-16 (low)	34



- \*1) When a broadcasting is performed, a response is not returned.
- \*2) Note that the value of starting address is one less than the actual address.
- \*3) Specify the number of bytes to be actually changed instead of the number of retention registers.



- When a writing to multiple coils cannot be executed normally, see “14.3.9 Exceptional Responses”.

**14.4.8** Writing and reading out to multiple registers [17h]

- Write and read out to consecutive multiple registers.

(Example) To the inverter with slave address “1”, to write 50.00Hz for the output frequency setting [FA-01] and read out output frequency monitor value [dA-01].

Query:

No.	Field Name	Example (Hex)	
1	Slave address	01	
2	Function code	17	
3	Readout register starting address (high) *1)	27	} (Register address) = (register No.) - 1
4	Readout register starting address (low) *1)	10	
5	The number of readout registers (high)	00	
6	The number of readout registers (low)	02	
7	Writing register starting address (high) *1)	2A	} (Register address) = (register No.) - 1
8	Writing register starting address (low) *1)	F8	
9	The number of writing registers (high)	00	
10	The number of writing registers (low)	02	
11	Writing data bytes n	04	
12	Writing data 1 (high)	00	} 0000 1388h → 5000d → 50.00Hz
13	Writing data 1 (low)	00	
14	Writing data 2 (high)	13	
15	Writing data 2 (low)	88	
16	CRC-16 (high)	F4	
17	CRC-16 (low)	86	

Response:

No.	Field Name	Example (Hex)	
1	Slave address	01	
2	Function code	17	
3	Readout data bytes n	04	
4	Readout data 1 (high)	00	} 0000 1388h → 5000d → 50.00Hz
5	Readout data 1 (low)	00	
6	Readout data 2 (high)	13	
7	Readout data 2 (low)	88	
8	CRC-16 (high)	F4	
9	CRC-16 (low)	71	



\*1) Note that the starting address of retention register is one less than the register No. The value obtained by subtracting one from the register No. is the register address.



- When a writing and reading out to multiple registers cannot be executed normally, see “3.9 Exceptional Responses”.

**14.4.9 Exceptional Responses**

- The master inverter requires a response to a query transmitted not by a broadcasting. • Inverters have to return responses corresponding to queries, but when there is an error in queries, inverters return an exceptional response.
- Details of field composition are showed. The value of function code is obtained by adding 80h to a query subjected to an exceptional response. An exception code indicates a factor of exceptional response.

Function code

Query	Exception Response
01h	81h
03h	83h
05h	85h
06h	86h
0Fh	8Fh
10h	90h
17h	97h

- Field composition for exceptional response is as shown below.

Field composition

Slave address
Function code
Exception code
CRC-16

Exception code

Code	Description
01h	An unsupported function was specified.
02h	The specified address does not exist.
03h	The specified data is in an unacceptable format.
21h	In writing to a retention register, the data is beyond the range of the inverter.
22h	The inverter is in the state that it doesn't permit functions to be executed as following: <ul style="list-style-type: none"> <li>• a register for which changes are inhibited during running was about to be changed;</li> <li>• data was written to a register to which soft-lock has been applied;</li> <li>• an ENTER instruction was executed during running;</li> <li>• an ENTER instruction was executed during undervoltage;</li> <li>• data was about to be written to a register when auto-tuning is enable; and so on.</li> </ul>
23h	A function code for writing was used to the parameter specialized for readout.
26h	Data was written during data writing or execution of data initialization.
27h	There was an access to only the higher side register of 2 register long parameter.

**14.4.10** Storing a change made to retention register

- The inverter doesn't store the data of changes even when the writing command to a retention register (06h) and the writing command to multiple registers (10h) are used.
- If the power of inverter is shut off without storing the data, the data will be restored to the condition before the retention register is changed.

■ ENTER instruction issuing method

- The writing of entire memory is performed when 1 is written to a retention register (9000(DEC)) using the writing command to a retention register (06h).

Cautions

- Do not turn OFF the power during data writing by an ENTER instruction. If the power is turned OFF, the data is not stored properly. Monitor the signal (coil No. 0049h) during data writing to determine whether the data is being written or not.
- Frequent use of ENTER instruction may shorten the life of converter because the inverter's memory element has the limit of the number of rewriting times. Use of ENTER instruction must be kept minimized, and especially periodic and/or successive issuance of this instruction must be completely avoided.

- To store in the inverter a change made to retention register, you need to issue ENTER instruction in the procedure shown below.
- To change control constants such as a motor constant, you need to use ENTER instruction and recalculate control processing internal variables.

■ Data writing mode

- The inverter enters the data writing mode when 1 is written to a retention register (9002 (DEC)) using the writing command to a retention register (06h).
- The data changed by the writing command to a retention register (06h) after the inverter enters the data writing mode will be written both in the RAM area for temporary saving and in the ROM area for storing in the event of power-off. Then simultaneously the data writing mode will be released.
- If the inverter receives commands other than the writing command to a retention register (06h) after entering the data writing mode, the data writing mode will be released.
- Frequent use of data writing mode may shorten the life of converter because the inverter's memory element has the limit of the number of rewriting times. Use of data writing mode must be kept minimized, and especially periodic and/or successive issuance of this mode must be completely avoided.

ENTER instruction

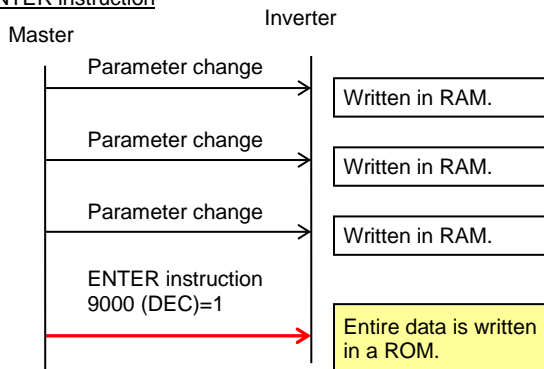

Data writing mode

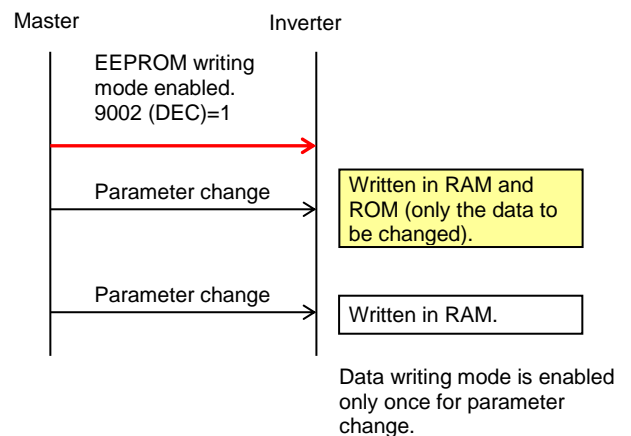

■ Recalculation of control processing internal variables

- Recalculation of control processing internal variables is performed when 1 is written to a retention register (9010 (DEC)) using the writing command to a retention register (06h).

### 14.5 EzCOM Function

#### 14.5.1 What is EzCOM?



• What is EzCOM?



- EzCOM is a function to allow multiple inverters to communicate each other without a master inverter such as PC and PLC, aside from normal Modbus-RTU communication (slave).
- Roles of inverters within the network of EzCOM are allocated to:
  - “Controlling inverter”
  - “Master inverter”
  - “Slave inverter”
- In the EzCOM network, the “controlling inverter” designates an inverter within the network as a “master inverter”, and the “master inverter” gives commands sequentially.
- As in the normal Modbus communication (RS-485), connect SP and SN terminals of respective inverters used in EzCOM communication.
- A master inverter is able to write 5 different commands to retention registers of arbitrary slave inverters.
- Once a data transmission between a master and slaves is completed, the controlling inverter shifts a master inverter sequentially and repeats a data transmission in accordance with the settings of respective master inverters.
- “Controlling inverter” is always fixed whereas “master inverter” is shifted sequentially. For this reason, the “controlling inverter” can be a “master inverter” or “slave inverter”.
- Up to 8 inverters can function as a “master inverter”.

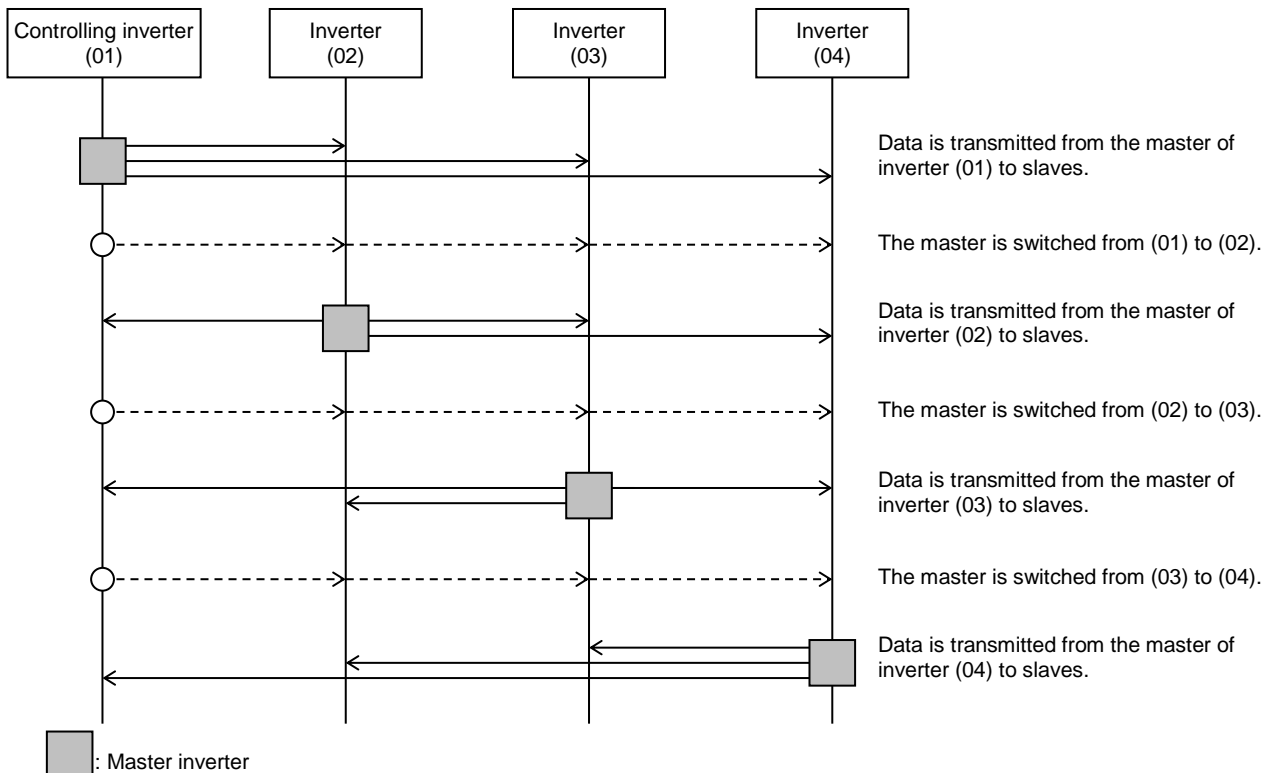



### 14.5.2 EzCOM Settings

- Set a station number for [CF-02] to each inverter of the EzCOM network, avoiding overlapping a station number. While doing so, make sure to assign a station number 01. The inverter with the station number 01 will be the “controlling inverter”.
- Set the communication selection of controlling inverter to EzCOM communication’s “controlling inverter” [CF-09]=02. Set the communication selection of other inverters to EzCOM communication [CF-09]=01.
- Set the EzCOM communication start method [CF-22] to the controlling inverter. If you selected the input terminal start [CF-22]=00, assign 098 [485:EzCOM start] to any of input terminals 1 - 9, A or B.
- To a master inverter, set the number of transmitting data, the station number of transmission destination, register of transmission destination, and register of transmission source that are required for the master inverter to write the data (see the following table).

Item	Parameter	Data	Set-up Destination	Description
Communication station number selection *1)	[CF-02]	1~247	ALL	Station number setting
Communication error operation selection	[CF-06]	00	ALL	Trip
		01	ALL	Trips after decelerating and stopping
		02	ALL	Ignore
		03	ALL	Free-run
		04	ALL	Deceleration stop
Communication timeout time	[CF-07]	0.00	ALL	Communication timeout disabled
		0.01~100.00	ALL	Unit [s]
Communication waiting time	[CF-08]	0.~1000.	ALL	Unit [ms]
Communication selection	[CF-09]	00	—	Modbus-RTU communication
		01	B	EzCOM communication
		02	A	EzCOM communication <controlling inverter>
EzCOM master start station number *2)	[CF-20]	01~08	A	Setting required for controlling inverter only.
EzCOM master end station number *2)	[CF-21]	01~08	A	Setting required for controlling inverter only.
EzCOM start selection	[CF-22]	00	A	Start-up by input terminal
		01	A	Always communication
Input terminal 1 to 9, A or B selection	[CA-01]~[CA-11]	098	A	[ECOM]: Starting up of EzCOM

#### ■ Set-up destinations

ALL: Set to all inverters used for EzCOM.

A: Set to only an inverter for controlling (station number 01).

B: Set to inverters other than an inverter for controlling (station number 01).

\*1) When you provide multiple master inverters, set consecutive station numbers (01, 02, 03, ...) to them. If the numbers are not consecutive, the inverters cannot perform communication.

\*2) Note that the relationship between the master start/end station number settings must be  $[CF-20] \leq [CF-21]$ .

### ■ Command settings for assigning master inverters

Item	Parameter	Data	Set-up Destination	Description
Number of EzCOM transmitting data	[CF-23]	01~05	M	Sets how many of the registers 1 to 5 shown below need to be transferred in EzCOM communication.
EzCOM transmission destination station number 1	[CF-24]	1~247	M	Station number for transmission destination 1.
EzCOM transmission destination register *3)	[CF-25]	0000h~FFFFh	M	Sets the high-order register of transmission destination 1.
EzCOM transmission source 1 register *3)	[CF-26]	0000h~FFFFh	M	Sets the low-order register of transmission destination 1.
EzCOM transmission destination station number 2	[CF-27]	1~247	M	Station number for transmission destination 2.
EzCOM transmission destination 2 register *3)	[CF-28]	0000h~FFFFh	M	Sets the high-order register of transmission destination 2.
EzCOM transmission source 2 register *3)	[CF-29]	0000h~FFFFh	M	Sets the low-order register of transmission destination 2.
EzCOM transmission destination station number 3	[CF-30]	1~247	M	Station number for transmission destination 3.
EzCOM transmission destination 3 register *3)	[CF-31]	0000h~FFFFh	M	Sets the high-order register of transmission destination 3.
EzCOM transmission source 3 register *3)	[CF-32]	0000h~FFFFh	M	Sets the low-order register of transmission destination 3.
EzCOM transmission destination station number 4	[CF-33]	1~247	M	Station number for transmission destination 4.
EzCOM transmission destination 4 register *3)	[CF-34]	0000h~FFFFh	M	Sets the high-order register of transmission destination 4.
EzCOM transmission source 4 register *3)	[CF-35]	0000h~FFFFh	M	Sets the low-order register of transmission destination 4.
EzCOM transmission destination station number 5	[CF-36]	1~247	M	Station number for transmission destination 5.
EzCOM transmission destination 5 register *3)	[CF-37]	0000h~FFFFh	M	Sets the high-order register of transmission destination 5.
EzCOM transmission source 5 register *3)	[CF-38]	0000h~FFFFh	M	Sets the low-order register of transmission destination 5.

### ■ Set-up destinations

M: Perform the setting to inverters having station numbers designated in [CF-20] and [CF-21] (= master inverters).

\*3) As for the transmission destination register and the transmission source register, specify the register address obtained by subtracting one from the register No. For information on register address, please contact the sales officer of our company shown on the back cover.

### 14.5.3 EzCOM Operation



- (1) A master inverter transmits data to slave inverters according to the settings made to the master inverter.
- (2) The controlling inverter transmits a master switching command, and then a master inverter is switched.
- (3) The next master inverter transmits data to slave inverters as described in (1).
- (4) Processes of (2) and (3) will follow, and the whole processes will be repeated likewise.



- Entire communication data is transmitted to all stations because EzCOM communication is performed by broadcast communication. As a result, a slave not designated as transmission destinations on the master side receives data once, but internally discards the data which is not addressed to it.

**14.5.4** Examples of EzCOM communication

- Shown below is communication sequences of inverters with station numbers 01 to 04 (four inverters in total), where the inverters 01 to 03 are designated as master inverters.

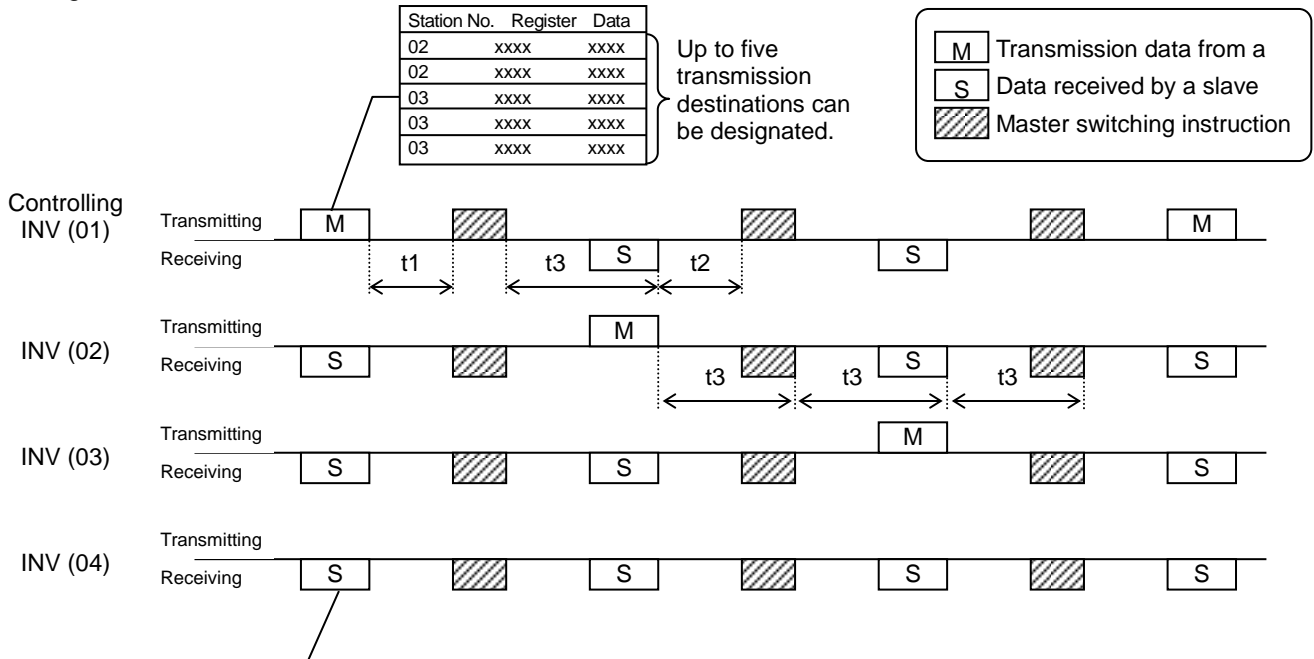

Although all slaves receive data from a master, if there is no data addressed to them, the received data by them will be discarded.

t1: Silent interval + communication waiting time [CF-07]  
 t2: Silent interval + communication waiting time [CF-07]  
 t3: Communication timeout time [CF-06]



- Communication timeout time [CF-06] for the controlling inverter, make sure to set value other than 0 (1 second or longer is recommended). Otherwise, the EzCOM function will stop when the communication is timed-out and data from a master inverter cannot be received. When the EzCOM function is stopped, reset the controlling inverter by turning on the power again or by resetting with the [RS] terminal.
- If the controlling inverter is a master inverter, a master switching instruction is transmitted after the master inverter transmits data followed by a silent interval + communication waiting time [CF-07] (aforementioned t1).
- If an inverter other than the controlling inverter is a master inverter, a master switching instruction is transmitted after the data from the master inverter is received followed by a silent interval + communication waiting time [CF-07] (aforementioned t2).
- The timer of communication timeout starts counting from the start of reception waiting. If data reception isn't completed within a set time, the communication will be timed-out (aforementioned t3), and the inverter behaves in accordance with the communication error selection [CF-05].



- When continuous communication [CF-22]=01 is selected in EzCOM start selection, the controlling inverter starts a transmission as soon as the power is turned ON. If the other inverters are turned ON late, a normal communication cannot be performed and the controlling inverter issues a communication timeout. Where always communication is selected, turn ON the controlling inverter after confirming that the other inverters have been turned ON.
- Do not set 08FFh (data writing) or 0901h (data writing mode selection) to transmission destination registers.
- If you changed settings of [CF-09] and [CF-20] - [CF-22], you can reflect the changes by turning on the power again or by resetting with the [RS] terminal.

## 14.6 Lists of Coils and Communication Registers

### 14.6.1 Precautions at setting registers and coils

- R or W shown in the lists indicates whether a coil or retention register can be used for readout or writing.  
R: only readout  
W: only writing  
R/W: both readout and writing
- Parameter shown in outline characters in the “Coil No. (decimal)” or “Function code” columns of the lists are parameters added in the Ver. 2.00. Do not access to those parameters for Ver.1.xx.
- See “Chapter 12 Inverter Functions” for details of setting range, and “Chapter 13 Monitoring Functions” for details of monitor. In addition, note that there are some parameters for which monitor and/or setting range varies depending on versions.
- The setting ranges shown in the lists are values in the condition where the parameter [CF-11] register data selection (A, V $\leftrightarrow$ % conversion function) is set to “00:(A, V)”.  
Note that where the parameter selection is set to “01:(%)”, monitor and setting range for a current/voltage related parameter is shown in percentage to the rated value.
- Note that, as shown in the tables below, register numbers and data types were changed from Ver.1.xx.

#### ① Frequency command (after calculation)

Ver.1.xx				Ver.2.00			
Function Code	Register No. (decimal)	Register No. (hexadecimal)	Monitor content	Function Code	Register No. (decimal)	Register No. (hexadecimal)	Monitor content
dA-04	10004	2714h	0 ~ 59000 (w/o sign)	<b>dA-04</b> <b>(dA-05)</b>	10004 (high)	2714h (high)	-59000 ~ 59000 (with sign)
					10005 (low)	2715h (low)	

#### ② RS485 Set frequency

Ver.1.xx				Ver.2.00			
Function Code	Register No. (decimal)	Register No. (hexadecimal)	Monitor content	Function Code	Register No. (decimal)	Register No. (hexadecimal)	Monitor content
-	10502 (high)	2906h (high)	0 ~ 59000 (with sign)	Not changed			-59000 ~ 59000 (with sign)
-	10503 (low)	2907h (low)					

#### ③ Auxiliary speed command (monitor + setting)

Ver.1.xx				Ver.2.00			
Function Code	Register No. (decimal)	Register No. (hexadecimal)	Monitor content	Function Code	Register No. (decimal)	Register No. (hexadecimal)	Monitor content
FA-02	11002	2AFAh	0 ~ 59000 (w/o sign)	<b>FA-02</b> <b>(FA-03)</b>	11002 (high)	2AFAh (high)	-59000 to +59000 (monitor)
					11003 (low)	2AFBh (low)	0 to 59000 (setting) (with sign)

## 14.6.2 List of coil numbers

Coil No. (decimal)	Coil No. (hexadecimal)	Item name	R/W	Setting description
0	0000h	(Reserved)		
1	0001h	Operation command	R/W	1: Run / 0: Stop (enabled when AA111/AA211=03)
2	0002h	Rotation direction command	R/W	1: Reverse / 0: Normal (enabled when AA111/AA211=03)
3	0003h	External trip [EXT]	R/W	1: Trip / 0: Not trip
4	0004h	Trip reset [RS]	R/W	1: Reset / 0: Not reset
5	0005h	Input terminal 1	R/W	1: ON/0: OFF
6	0006h	Input terminal 2	R/W	1: ON/0: OFF
7	0007h	Input terminal 3	R/W	1: ON/0: OFF
8	0008h	Input terminal 4	R/W	1: ON/0: OFF
9	0009h	Input terminal 5	R/W	1: ON/0: OFF
10	000Ah	Input terminal 6	R/W	1: ON/0: OFF
11	000Bh	Input terminal 7	R/W	1: ON/0: OFF
12	000Ch	Input terminal 8	R/W	1: ON/0: OFF
13	000Dh	Input terminal 9	R/W	1: ON/0: OFF
14	000Eh	Input terminal A	R/W	1: ON/0: OFF
15	000Fh	Input terminal B	R/W	1: ON/0: OFF
16	0010h	(Reserved)		
~	~	(Reserved)		
20	0014h	(Reserved)		
21	0015h	Operating status	R	1: Rotating in normal direction, rotating in reverse direction / 0: Other than rotating in normal/reverse rotation (linked with dA-03)
22	0016h	Rotation direction	R	1: Rotating in reverse direction / 0: Rotating in normal direction (linked with dA-03)
23	0017h	Inverter operation ready completion	R	1: Ready / 0: Not ready
24	0018h	(Reserved)		
25	0019h	Output terminal 11	R	1: ON/0: OFF
26	001Ah	Output terminal 12	R	1: ON/0: OFF
27	001Bh	Output terminal 13	R	1: ON/0: OFF
28	001Ch	Output terminal 14	R	1: ON/0: OFF
29	001Dh	Output terminal 15	R	1: ON/0: OFF
30	001Eh	Output terminal 16	R	1: ON/0: OFF
31	001Fh	Output terminal AL	R	1: ON/0: OFF
32	0020h	(Reserved)		
~	~			
72	0048h	(Reserved)		
73	0049h	Data being written	R	1: Being written / 0: Normal state
74	004Ah	CRC error	R	1: With error / 0: No error
75	004Bh	Overrun error	R	1: With error / 0: No error
76	004Ch	Framing error	R	1: With error / 0: No error
77	004Dh	Parity error	R	1: With error / 0: No error
78	004Eh	Sum check error	R	1: With error / 0: No error
79~	004Fh~	(Reserved)		

### 14.6.3 List of retention register numbers

(Monitor (Code-d))

Function Code	Register No. (decimal)	Register No. (hexadecimal)	Function Name	R/W	Monitor Content and Setting Item	Data Resolution / Unit
dA-01	10001	2711h	Output frequency monitor	R	0 ~ 59000	0.01Hz
dA-02	10002	2712h	Output current monitor	R	0 ~ 65535	0.01A
dA-03	10003	2713h	Operation direction monitor	R	0 ~ 3	1
<b>dA-04</b>	10004	2714h	Frequency command (after calculation)	R	-59000 ~ 59000 (Register No. and monitor range are not the same with Ver1.xx.)	0.01Hz
<b>(dA-05)</b>	10005	2715h				
dA-06	10006	2716h	Output frequency conversion monitor	R	0 ~ 5900000	0.01
<b>(dA-07)</b>	10007	2717h				
<b>dA-08</b>	10008	2718h	Speed detection value monitor	R	-59000 ~ 59000	0.01Hz
<b>(dA-09)</b>	10009	2719h				
<b>dA-12</b>	10012	271Ch	Output frequency monitor (with sign)	R	-59000 ~ 59000	0.01Hz
<b>(dA-13)</b>	10013	271Dh				
<b>dA-14</b>	10014	271Eh	Frequency upper limit monitor	R	0 ~ 59000	0.01Hz
dA-15	10015	271Fh	Torque command monitor (after calculation)	R	-10000 ~ 10000	0.1%
dA-16	10016	2720h	Torque limit monitor	R	0 ~ 5000	0.1%
dA-17	10017	2721h	Output torque monitor	R	-10000 ~ 10000	0.1%
dA-18	10018	2722h	Output voltage monitor	R	0 ~ 8000	0.1V
<b>dA-20</b>	10020	2724h	Current position monitor	R	-268435455 ~ 268435455 In high resolution mode: -1073741823 to 1073741823	1pls
<b>(dA-21)</b>	10021	2725h				
<b>dA-26</b>	10026	272Ah	Pulse train position deviation monitor	R	-2147483647 ~ 2147483647	1pls
<b>(dA-27)</b>	10027	272Bh				
dA-28	10028	272Ch	Pulse counter monitor	R	0 ~ 2147483647	1pls
<b>(dA-29)</b>	10029	272Dh				
dA-30	10030	272Eh	Input power monitor	R	0 ~ 60000 (~132kW) 0~20000 (160kW~)	0.01kWh 0.1kWh
dA-32	10032	2730h	Integrated input power monitor	R	0 ~ 10000000	0.1kWh
<b>(dA-33)</b>	10033	2731h				
dA-34	10034	2732h	Output power monitor	R	0 ~ 60000 (~132kW) 0~20000 (160kW~)	0.01kWh 0.1kWh
dA-36	10036	2734h	Integrated output power monitor	R	0 ~ 10000000	0.1kWh
<b>(dA-37)</b>	10037	2735h				
<b>dA-38</b>	10038	2736h	Motor temperature monitor	R	-200 ~ 2000	0.1°C
dA-40	10040	2738h	DC voltage monitor	R	0 ~ 10000	0.1Vdc
dA-41	10041	2739h	BRD load factor monitor	R	0 ~ 10000	0.01%
dA-42	10042	273Ah	Electronic thermal load factor monitor (MTR)	R	0 ~ 10000	0.01%
dA-43	10043	273Bh	Electronic thermal load factor monitor (CTL)	R	0 ~ 10000	0.01%
dA-45	10045	273Dh	Safety STO monitor	R	0 ~ 7	1
<b>dA-46</b>	10046	273Eh	Safety option hardware monitor	R	0 ~ 0xFFFF	1
<b>dA-47</b>	10047	273Fh	Safety option function monitor	R	0 ~ 6	1
<b>dA-50</b>	10050	2742h	Terminal block option mounted state	R	0 ~ 15	1
dA-51	10051	2743h	Input terminal monitor	R	0 ~ 0xFFFF	1
dA-54	10054	2746h	Output terminal monitor	R	0 ~ 0xFF	1

Function Code	Register No. (decimal)	Register No. (hexadecimal)	Function Name	R/W	Monitor Content and Setting Item	Data Resolution / Unit
dA-60	10060	274Ch	Analog I/O selection monitor	R	0 ~ 0xFF	1
dA-61	10061	274Dh	Analog input [Ai1] monitor	R	0 ~ 10000	0.01%
dA-62	10062	274Eh	Analog input [Ai2] monitor	R	0 ~ 10000	0.01%
dA-63	10063	274Fh	Analog input [Ai3] monitor	R	-10000 ~ 10000	0.01%
<b>dA-64</b>	10064	2750h	Extended analog input [Ai4] monitor	R	0 ~ 10000	0.01%
<b>dA-65</b>	10065	2751h	Extended analog input [Ai5] monitor	R	0 ~ 10000	0.01%
<b>dA-66</b>	10066	2752h	Extended analog input [Ai6] monitor	R	-10000 ~ 10000	0.01%
dA-70	10070	2756h	Pulse train input monitor (inverter)	R	-10000 ~ 10000	0.01%
<b>dA-71</b>	10071	2757h	Pulse train input monitor (option)	R	-10000 ~ 10000	0.01%
dA-81	10081	2761h	Option slot 1 mounted state	R	0 ~ 48	1
dA-82	10082	2762h	Option slot 2 mounted state	R	0 ~ 48	1
dA-83	10083	2763h	Option slot 3 mounted state	R	0 ~ 48	1
db-01	10101	2775h	Program download monitor	R	0 ~ 1	1
db-02	10102	2776h	Program No. monitor	R	0 ~ 9999	1
db-03	10103	2777h	Program counter (Task-1)	R	1 ~ 1024	1
db-04	10104	2778h	Program counter (Task-2)	R	1 ~ 1024	1
db-05	10105	2779h	Program counter (Task-3)	R	1 ~ 1024	1
db-06	10106	277Ah	Program counter (Task-4)	R	1 ~ 1024	1
db-07	10107	277Bh	Program counter (Task-5)	R	1 ~ 1024	1
db-08	10108	277Ch	User monitor 0 (High)	R	-2147483647 ~ 2147483647	1
(db-09)	10109	277Dh	(Low)			
db-10	10110	277Eh	User monitor 1 (High)	R	-2147483647 ~ 2147483647	1
(db-11)	10111	277Fh	(Low)			
db-12	10112	2780h	User monitor 2 (High)	R	-2147483647 ~ 2147483647	1
(db-13)	10113	2781h	(Low)			
db-14	10114	2782h	User monitor 3 (High)	R	-2147483647 ~ 2147483647	1
(db-15)	10115	2783h	(Low)			
db-16	10116	2784h	User monitor 4 (High)	R	-2147483647 ~ 2147483647	1
(db-17)	10117	2785h	(Low)			
db-18	10118	2786h	Analog output monitor YA0	R	0 ~ 10000	0.01%
db-19	10119	2787h	Analog output monitor YA1	R	0 ~ 10000	0.01%
db-20	10120	2788h	Analog output monitor YA2	R	0 ~ 10000	0.01%
<b>db-21</b>	10121	2789h	Analog output monitor YA3	R	0 ~ 10000	0.01%
<b>db-22</b>	10122	278Ah	Analog output monitor YA4	R	0 ~ 10000	0.01%
<b>db-23</b>	10123	278Bh	Analog output monitor YA5	R	0 ~ 10000	0.01%
db-30	10130	2792h	PID1 feedback data 1 monitor (High)	R	-10000 ~ 10000	Per AH-06 setting
(db-31)	10131	2793h	(Low)			
db-32	10132	2794h	PID1 feedback data 2 monitor (High)	R	-10000 ~ 10000	Per AH-06 setting
(db-33)	10133	2795h	(Low)			
<b>db-34</b>	10134	2796h	PID1 feedback data 3 monitor (High)	R	-10000 ~ 10000	Per AH-06 setting
<b>(db-35)</b>	10135	2797h	(Low)			
db-36	10136	2798h	PID2 feedback data monitor (High)	R	-10000 ~ 10000	Per AJ-06 setting
(db-37)	10137	2799h	(Low)			
<b>db-38</b>	10138	279Ah	PID3 feedback data monitor (High)	R	-10000 ~ 10000	Per AJ-26 setting
<b>(db-39)</b>	10139	279Bh	(Low)			
<b>db-40</b>	10140	279Ch	PID4 feedback data monitor (High)	R	-10000 ~ 10000	Per AJ-46 setting
<b>(db-41)</b>	10141	279Dh	(Low)			



Function Code	Register No. (decimal)	Register No. (hexadecimal)	Function Name	R/W	Monitor Content and Setting Item	Data Resolution / Unit
db-42	10142	279Eh	PID1 target value monitor (after calculation) (High)	R	-10000 ~ 10000	Per AH-06 setting
(db-43)	10143	279Fh	(Low)			
db-44	10144	27A0h	PID1 feedback data monitor (after calculation) (High)	R	-10000 ~ 10000	Per AH-06 setting
(db-45)	10145	27A1h	(Low)			
db-50	10150	27A6h	PID1 output monitor	R	-10000 ~ 10000	0.01%
db-51	10151	27A7h	PID1 deviation monitor	R	-10000 ~ 10000	0.01%
<b>db-52</b>	10152	27A8h	PID1 deviation 1 monitor	R	-10000 ~ 10000	0.01%
<b>db-53</b>	10153	27A9h	PID1 deviation 2 monitor	R	-10000 ~ 10000	0.01%
<b>db-54</b>	10154	27AAh	PID1 deviation 3 monitor	R	-10000 ~ 10000	0.01%
db-55	10155	27ABh	PID2 output monitor	R	-10000 ~ 10000	0.01%
db-56	10156	27ACH	PID2 deviation monitor	R	-10000 ~ 10000	0.01%
<b>db-57</b>	10157	27ADh	PID3 output monitor	R	-10000 ~ 10000	0.01%
<b>db-58</b>	10158	27AEh	PID3 deviation monitor	R	-10000 ~ 10000	0.01%
<b>db-59</b>	10159	27AFh	PID4 output monitor	R	-10000 ~ 10000	0.01%
<b>db-60</b>	10160	27B0h	PID4 deviation monitor	R	-10000 ~ 10000	0.01%
db-61	10161	27B1h	PID current P gain monitor	R	0 ~ 1000	0.1 x
db-62	10162	27B2h	PID current I gain monitor	R	0 ~ 36000	0.1s
db-63	10163	27B3h	PID current D gain monitor	R	0 ~ 10000	0.01s
db-64	10164	27B4h	PID feed forward monitor	R	0 ~ 10000	0.01%
dC-01	10201	27D9h	Inverter load type selection monitor	R	0 ~ 2	1
dC-02	10202	27DAh	Rated current monitor	R	0 ~ 65535	0.1A
dC-07	10207	27DFh	Speed command destination monitor (main)	R	0 ~ 34	1
dC-08	10208	27E0h	Speed command destination monitor (auxiliary)	R	0 ~ 34	1
dC-10	10210	27E2h	Operation command destination monitor	R	0 ~ 6	1
dC-15	10215	27E7h	Cooling fin temperature monitor	R	-200 ~ 2000	0.1°C
dC-16	10216	27E8h	Life diagnostic monitor	R	0 ~ 0xFF	1
dC-20	10220	27ECh	Total start-up count	R	1 ~ 65535	1
dC-21	10221	27EDh	Power-on count	R	1 ~ 65535	1
dC-22	10222	27EEh	Cumulative operating hours monitor during RUN (High)	R	0 ~ 1000000	1hr
(dC-23)	10223	27EFh	(Low)			
dC-24	10224	27F0h	Cumulative power-on time (High)	R	0 ~ 1000000	1hr
(dC-25)	10225	27F1h	(Low)			
dC-26	10226	27F2h	Cumulative operating time of cooling fan (High)	R	0 ~ 1000000	1hr
(dC-27)	10227	27F3h	(Low)			
dC-37	10237	27FDh	Detailed monitor for icon 2 LIM	R	0 ~ 6	1
dC-38	10238	27FEh	Detailed monitor for icon 2 LIM	R	0 ~ 4	1
dC-39	10239	27FFh	Detailed monitor for icon 2 RETRY	R	0 ~ 2	1
dC-40	10240	2800h	Detailed monitor for icon 2 NRDY	R	0 ~ 9	1
dC-45	10245	2805h	IM/SM monitor	R	0 ~ 1	1
dC-50	10250	280Ah	Firmware Ver. monitor	R	0 ~ 0xFFFF Higher 1 byte: Major Lower 1 byte: Minor 1	1
<b>dC-53</b>	10253	280Dh	Firmware Gr. monitor	R	0 ~ 1	1

(Trip monitor)

Function Code	Register No. (decimal)	Register No. (hexadecimal)	Function Name	R/W	Monitor Content and Setting Item	Data Resolution / Unit
Trip monitor (dE-01)	1000	03E8h	Trip count monitor	R	0 ~ 65535	1
Trip monitor (dE-11)	1001	03E9h	Trip monitor 1 Factor	R	1 ~ 255	1
	1002	03EAh	Trip monitor 1 Output frequency (High)	R	-59000 ~ 59000	0.01Hz
	1003	03EBh	(with sign) (Low)			
	1004	03ECh	Trip monitor 1 Output current	R	0 ~ 65535	0.01A
	1005	03EDh	Trip monitor 1 P-N DC voltage	R	0 ~ 10000	0.1Vdc
	1006	03EEh	Trip monitor 1 Inverter state	R	0 ~ 8	1
	1007	03EFh	Trip monitor 1 LAD state	R	0 ~ 5	1
	1008	03F0h	Trip monitor 1 INV control mode	R	0 ~ 11	1
	1009	03F1h	Trip monitor 1 Limit state	R	0 ~ 6	1
	1010	03F2h	Trip monitor 1 Special state	R	0 ~ 6	1
	1012	03F4h	Trip monitor 1 RUN time (High)	R	0 ~ 1000000	1hr
	1013	03F5h	(Low)			
	1014	03F6h	Trip monitor 1 Power ON time (High)	R	0 ~ 1000000	1hr
	1015	03F7h	(Low)			
	1016	03F8h	Trip monitor 1 Absolute time (year, month)	R	00 - 99 (BCD code)	1
R				01 - 12 (BCD code)	1	
1017	03F9h	Trip monitor 1 Absolute time (day, day of the week)	R	01 - 31 (BCD code)	1	
			R	00 - 06 (BCD code)	1	
1018	03FAh	Trip monitor 1 Absolute time (hour, minute)	R	00 - 23 (BCD code)	1	
			R	00 - 59 (BCD code)	1	
Trip monitor (dE-12)	1021	03FDh	Trip monitor 2 Factor	R	1 ~ 255	1
	1022	03FEh	Trip monitor 2 Output frequency (High)	R	-59000 ~ 59000	0.01Hz
	1023	03FFh	(with sign) (Low)			
	1024	0400h	Trip monitor 2 Output current	R	0 ~ 65535	0.01A
	1025	0401h	Trip monitor 2 P-N DC voltage	R	0 ~ 10000	0.1Vdc
	1026	0402h	Trip monitor 2 Inverter state	R	0 ~ 8	1
	1027	0403h	Trip monitor 2 LAD state	R	0 ~ 5	1
	1028	0404h	Trip monitor 2 INV control mode	R	0 ~ 11	1
	1029	0405h	Trip monitor 2 Limit state	R	0 ~ 6	1
	1030	0406h	Trip monitor 2 Special state	R	0 ~ 6	1
	1032	0408h	Trip monitor 2 RUN time (High)	R	0 ~ 1000000	1hr
	1033	0409h	(Low)			
	1034	040Ah	Trip monitor 2 Power ON time (High)	R	0 ~ 1000000	1hr
	1035	040Bh	(Low)			
	1036	040Ch	Trip monitor 2 Absolute time (year, month)	R	00 - 99 (BCD code)	1
R				01 - 12 (BCD code)	1	
1037	040Dh	Trip monitor 2 Absolute time (day, day of the week)	R	01 - 31 (BCD code)	1	
			R	00 - 06 (BCD code)	1	
1038	040Eh	Trip monitor 2 Absolute time (hour, minute)	R	00 - 23 (BCD code)	1	
			R	00 - 59 (BCD code)	1	

Function Code	Register No. (decimal)	Register No. (hexadecimal)	Function Name	R/W	Monitor Content and Setting Item	Data Resolution / Unit
Trip monitor (dE-13)	1041	0411h	Trip monitor 3 Factor	R	1 ~ 255	1
	1042	0412h	Trip monitor 3 Output frequency (High)	R	-59000 ~ 59000	0.01Hz
	1043	0413h	(with sign) (Low)			
	1044	0414h	Trip monitor 3 Output current	R	0 ~ 65535	0.01A
	1045	0415h	Trip monitor 3 P-N DC voltage	R	0 ~ 10000	0.1Vdc
	1046	0416h	Trip monitor 3 Inverter state	R	0 ~ 8	1
	1047	0417h	Trip monitor 3 LAD state	R	0 ~ 5	1
	1048	0418h	Trip monitor 3 INV control mode	R	0 ~ 11	1
	1049	0419h	Trip monitor 3 Limit state	R	0 ~ 6	1
	1050	041Ah	Trip monitor 3 Special state	R	0 ~ 6	1
	1052	041Ch	Trip monitor 3 RUN time (High)	R	0 ~ 1000000	1hr
	1053	041Dh	(Low)			
	1054	041Eh	Trip monitor 3 Power ON time (High)	R	0 ~ 1000000	1hr
	1055	041Fh	(Low)			
1056	0420h	Trip monitor 3 Absolute time (year, month)	R	00 - 99 (BCD code) 01 - 12 (BCD code)	1 1	
1057	0421h	Trip monitor 3 Absolute time (day, day of the week)	R	01 - 31 (BCD code) 00 - 06 (BCD code)	1 1	
1058	0422h	Trip monitor 3 Absolute time (hour, minute)	R	00 - 23 (BCD code) 00 - 59 (BCD code)	1 1	
Trip monitor (dE-14)	1061	0425h	Trip monitor 4 Factor	R	1 ~ 255	1
	1062	0426h	Trip monitor 4 Output frequency (High)	R	-59000 ~ 59000	0.01Hz
	1063	0427h	(with sign) (Low)			
	1064	0428h	Trip monitor 4 Output current	R	0 ~ 65535	0.01A
	1065	0429h	Trip monitor 4 P-N DC voltage	R	0 ~ 10000	0.1Vdc
	1066	042Ah	Trip monitor 4 Inverter state	R	0 ~ 8	1
	1067	042Bh	Trip monitor 4 LAD state	R	0 ~ 5	1
	1068	042Ch	Trip monitor 4 INV control mode	R	0 ~ 11	1
	1069	042Dh	Trip monitor 4 Limit state	R	0 ~ 6	1
	1070	042Eh	Trip monitor 4 Special state	R	0 ~ 6	1
	1072	0430h	Trip monitor 4 RUN time (High)	R	0 ~ 1000000	1hr
	1073	0431h	(Low)			
	1074	0432h	Trip monitor 4 Power ON time (High)	R	0 ~ 1000000	1hr
	1075	0433h	(Low)			
1076	0434h	Trip monitor 4 Absolute time (year, month)	R	00 - 99 (BCD code) 01 - 12 (BCD code)	1 1	
1077	0435h	Trip monitor 4 Absolute time (day, day of the week)	R	01 - 31 (BCD code) 00 - 06 (BCD code)	1 1	
1078	0436h	Trip monitor 4 Absolute time (hour, minute)	R	00 - 23 (BCD code) 00 - 59 (BCD code)	1 1	

Function Code	Register No. (decimal)	Register No. (hexadecimal)	Function Name	R/W	Monitor Content and Setting Item	Data Resolution / Unit
Trip monitor (dE-15)	1081	0439h	Trip monitor 5 Factor	R	1 ~ 255	1
	1082	043Ah	Trip monitor 5 Output frequency (High)	R	-59000 ~ 59000	0.01Hz
	1083	043Bh	(with sign) (Low)			
	1084	043Ch	Trip monitor 5 Output current	R	0 ~ 65535	0.01A
	1085	043Dh	Trip monitor 5 P-N DC voltage	R	0 ~ 10000	0.1Vdc
	1086	043Eh	Trip monitor 5 Inverter state	R	0 ~ 8	1
	1087	043Fh	Trip monitor 5 LAD state	R	0 ~ 5	1
	1088	0440h	Trip monitor 5 INV control mode	R	0 ~ 11	1
	1089	0441h	Trip monitor 5 Limit state	R	0 ~ 6	1
	1090	0442h	Trip monitor 5 Special state	R	0 ~ 6	1
	1092	0444h	Trip monitor 5 RUN time (High)	R	0 ~ 1000000	1hr
	1093	0445h	(Low)			
	1094	0446h	Trip monitor 5 Power ON time (High)	R	0 ~ 1000000	1hr
	1095	0447h	(Low)			
1096	0448h	Trip monitor 5 Absolute time (year, month)	R	00 - 99 (BCD code) 01 - 12 (BCD code)	1 1	
1097	0449h	Trip monitor 5 Absolute time (day, day of the week)	R	01 - 31 (BCD code) 00 - 06 (BCD code)	1 1	
1098	044Ah	Trip monitor 5 Absolute time (hour, minute)	R	00 - 23 (BCD code) 00 - 59 (BCD code)	1 1	
Trip monitor (dE-16)	1101	044Dh	Trip monitor 6 Factor	R	1 ~ 255	1
	1102	044Eh	Trip monitor 6 Output frequency (High)	R	-59000 ~ 59000	0.01Hz
	1103	044Fh	(with sign) (Low)			
	1104	0450h	Trip monitor 6 Output current	R	0 ~ 65535	0.01A
	1105	0451h	Trip monitor 6 P-N DC voltage	R	0 ~ 10000	0.1Vdc
	1106	0452h	Trip monitor 6 Inverter state	R	0 ~ 8	1
	1107	0453h	Trip monitor 6 LAD state	R	0 ~ 5	1
	1108	0454h	Trip monitor 6 INV control mode	R	0 ~ 11	1
	1109	0455h	Trip monitor 6 Limit state	R	0 ~ 6	1
	1110	0456h	Trip monitor 6 Special state	R	0 ~ 6	1
	1112	0458h	Trip monitor 6 RUN time (High)	R	0 ~ 1000000	1hr
	1113	0459h	(Low)			
	1114	045Ah	Trip monitor 6 Power ON time (High)	R	0 ~ 1000000	1hr
	1115	045Bh	(Low)			
1116	045Ch	Trip monitor 6 Absolute time (year, month)	R	00 - 99 (BCD code) 01 - 12 (BCD code)	1 1	
1117	045Dh	Trip monitor 6 Absolute time (day, day of the week)	R	01 - 31 (BCD code) 00 - 06 (BCD code)	1 1	
1118	045Eh	Trip monitor 6 Absolute time (hour, minute)	R	00 - 23 (BCD code) 00 - 59 (BCD code)	1 1	

Function Code	Register No. (decimal)	Register No. (hexadecimal)	Function Name	R/W	Monitor Content and Setting Item	Data Resolution / Unit
Trip monitor (dE-17)	1121	0461h	Trip monitor 7 Factor	R	1 ~ 255	1
	1122	0462h	Trip monitor 7 Output frequency (High)	R	-59000 ~ 59000	0.01Hz
	1123	0463h	(with sign) (Low)			
	1124	0464h	Trip monitor 7 Output current	R	0 ~ 65535	0.01A
	1125	0465h	Trip monitor 7 P-N DC voltage	R	0 ~ 10000	0.1Vdc
	1126	0466h	Trip monitor 7 Inverter state	R	0 ~ 8	1
	1127	0467h	Trip monitor 7 LAD state	R	0 ~ 5	1
	1128	0468h	Trip monitor 7 INV control mode	R	0 ~ 11	1
	1129	0469h	Trip monitor 7 Limit state	R	0 ~ 6	1
	1130	046Ah	Trip monitor 7 Special state	R	0 ~ 6	1
	1132	046Ch	Trip monitor 7 RUN time (High)	R	0 ~ 1000000	1hr
	1133	046Dh	(Low)			
	1134	046Eh	Trip monitor 7 Power ON time (High)	R	0 ~ 1000000	1hr
	1135	046Fh	(Low)			
	1136	0470h	Trip monitor 7 Absolute time (year, month)	R	00 - 99 (BCD code) 01 - 12 (BCD code)	1 1
1137	0471h	Trip monitor 7 Absolute time (day, day of the week)	R	01 - 31 (BCD code) 00 - 06 (BCD code)	1 1	
1138	0472h	Trip monitor 7 Absolute time (hour, minute)	R	00 - 23 (BCD code) 00 - 59 (BCD code)	1 1	
Trip monitor (dE-18)	1141	0475h	Trip monitor 8 Factor	R	1 ~ 255	1
	1142	0476h	Trip monitor 8 Output frequency (High)	R	-59000 ~ 59000	0.01Hz
	1143	0477h	(with sign) (Low)			
	1144	0478h	Trip monitor 8 Output current	R	0 ~ 65535	0.01A
	1145	0479h	Trip monitor 8 P-N DC voltage	R	0 ~ 10000	0.1Vdc
	1146	047Ah	Trip monitor 8 Inverter state	R	0 ~ 8	1
	1147	047Bh	Trip monitor 8 LAD state	R	0 ~ 5	1
	1148	047Ch	Trip monitor 8 INV control mode	R	0 ~ 11	1
	1149	047Dh	Trip monitor 8 Limit state	R	0 ~ 6	1
	1150	047Eh	Trip monitor 8 Special state	R	0 ~ 6	1
	1152	0480h	Trip monitor 8 RUN time (High)	R	0 ~ 1000000	1hr
	1153	0481h	(Low)			
	1154	0482h	Trip monitor 8 Power ON time (High)	R	0 ~ 1000000	1hr
	1155	0483h	(Low)			
	1156	0484h	Trip monitor 8 Absolute time (year, month)	R	00 - 99 (BCD code) 01 - 12 (BCD code)	1 1
1157	0485h	Trip monitor 8 Absolute time (day, day of the week)	R	01 - 31 (BCD code) 00 - 06 (BCD code)	1 1	
1158	0486h	Trip monitor 8 Absolute time (hour, minute)	R	00 - 23 (BCD code) 00 - 59 (BCD code)	1 1	

Function Code	Register No. (decimal)	Register No. (hexadecimal)	Function Name	R/W	Monitor Content and Setting Item	Data Resolution / Unit
Trip monitor (dE-19)	1161	0489h	Trip monitor 9 Factor	R	1 ~ 255	1
	1162	048Ah	Trip monitor 9 Output frequency (High)	R	-59000 ~ 59000	0.01Hz
	1163	048Bh	(with sign) (Low)			
	1164	048Ch	Trip monitor 9 Output current	R	0 ~ 65535	0.01A
	1165	048Dh	Trip monitor 9 P-N DC voltage	R	0 ~ 10000	0.1Vdc
	1166	048Eh	Trip monitor 9 Inverter state	R	0 ~ 8	1
	1167	048Fh	Trip monitor 9 LAD state	R	0 ~ 5	1
	1168	0490h	Trip monitor 9 INV control mode	R	0 ~ 11	1
	1169	0491h	Trip monitor 9 Limit state	R	0 ~ 6	1
	1170	0492h	Trip monitor 9 Special state	R	0 ~ 6	1
	1172	0494h	Trip monitor 9 RUN time (High)	R	0 ~ 1000000	1hr
	1173	0495h	(Low)			
	1174	0496h	Trip monitor 9 Power ON time (High)	R	0 ~ 1000000	1hr
	1175	0497h	(Low)			
	1176	0498h	Trip monitor 9 Absolute time (year, month)	R	00 - 99 (BCD code) 01 - 12 (BCD code)	1 1
1177	0499h	Trip monitor 9 Absolute time (day, day of the week)	R	01 - 31 (BCD code) 00 - 06 (BCD code)	1 1	
1178	049Ah	Trip monitor 9 Absolute time (hour, minute)	R	00 - 23 (BCD code) 00 - 59 (BCD code)	1 1	
Trip monitor (dE-20)	1181	049Dh	Trip monitor 10 Factor	R	1 ~ 255	1
	1182	049Eh	Trip monitor 10 Output frequency (High)	R	-59000 ~ 59000	0.01Hz
	1183	049Fh	(with sign) (Low)			
	1184	04A0h	Trip monitor 10 Output current	R	0 ~ 65535	0.01A
	1185	04A1h	Trip monitor 10 P-N DC voltage	R	0 ~ 10000	0.1Vdc
	1186	04A2h	Trip monitor 10 Inverter state	R	0 ~ 8	1
	1187	04A3h	Trip monitor 10 LAD state	R	0 ~ 5	1
	1188	04A4h	Trip monitor 10 INV control mode	R	0 ~ 11	1
	1189	04A5h	Trip monitor 10 Limit state	R	0 ~ 6	1
	1190	04A6h	Trip monitor 10 Special state	R	0 ~ 6	1
	1192	04A8h	Trip monitor 10 RUN time (High)	R	0 ~ 1000000	1hr
	1193	04A9h	(Low)			
	1194	04AAh	Trip monitor 10 Power ON time (High)	R	0 ~ 1000000	1hr
	1195	04ABh	(Low)			
	1196	04ACh	Trip monitor 10 Absolute time (year, month)	R	00 - 99 (BCD code) 01 - 12 (BCD code)	1 1
1197	04ADh	Trip monitor 10 Absolute time (day, day of the week)	R	01 - 31 (BCD code) 00 - 06 (BCD code)	1 1	
1198	04AEh	Trip monitor 10 Absolute time (hour, minute)	R	00 - 23 (BCD code) 00 - 59 (BCD code)	1 1	

(Retry monitor)

Function Code	Register No. (decimal)	Register No. (hexadecimal)	Function Name	R/W	Monitor Content and Setting Item	Data Resolution / Unit
Retry monitor (dE-31)	1201	04B1h	Retry monitor 1 Factor	R	1 ~ 255	1
	1202	04B2h	Retry monitor 1 Output frequency (High)	R	-59000 ~ 59000	0.01Hz
	1203	04B3h	(with sign) (Low)			
	1204	04B4h	Retry monitor 1 Output current	R	0 ~ 65535	0.01A
	1205	04B5h	Retry monitor 1 P-N DC voltage	R	0 ~ 10000	0.1Vdc
	1206	04B6h	Retry monitor 1 Inverter state	R	0 ~ 8	1
	1207	04B7h	Retry monitor 1 LAD state	R	0 ~ 5	1
	1208	04B8h	Retry monitor 1 INV control mode	R	0 ~ 11	1
	1209	04B9h	Retry monitor 1 Limit state	R	0 ~ 6	1
	1210	04BAh	Retry monitor 1 Special state	R	0 ~ 6	1
	1212	04BCh	Retry monitor 1 RUN time (High)	R	0 ~ 1000000	1hr
	1213	04BDh	(Low)			
	1214	04BEh	Retry monitor 1 Power ON time (High)	R	0 ~ 1000000	1hr
	1215	04BFh	(Low)			
	1216	04C0h	Retry monitor 1 Absolute time (year, month)	R	00 - 99 (BCD code) 01 - 12 (BCD code)	1 1
	1217	04C1h	Retry monitor 1 Absolute time (day, day of the week)	R	01 - 31 (BCD code) 00 - 06 (BCD code)	1 1
1218	04C2h	Retry monitor 1 Absolute time (hour, minute)	R	00 - 23 (BCD code) 00 - 59 (BCD code)	1 1	
Retry monitor (dE-32)	1221	04C5h	Retry monitor 2 Factor	R	1 ~ 255	1
	1222	04C6h	Retry monitor 2 Output frequency (High)	R	-59000 ~ 59000	0.01Hz
	1223	04C7h	(with sign) (Low)			
	1224	04C8h	Retry monitor 2 Output current	R	0 ~ 65535	0.01A
	1225	04C9h	Retry monitor 2 P-N DC voltage	R	0 ~ 10000	0.1Vdc
	1226	04CAh	Retry monitor 2 Inverter state	R	0 ~ 8	1
	1227	04CBh	Retry monitor 2 LAD state	R	0 ~ 5	1
	1228	04CCh	Retry monitor 2 INV control mode	R	0 ~ 11	1
	1229	04CDh	Retry monitor 2 Limit state	R	0 ~ 6	1
	1230	04CEh	Retry monitor 2 Special state	R	0 ~ 6	1
	1232	04D0h	Retry monitor 2 RUN time (High)	R	0 ~ 1000000	1hr
	1233	04D1h	(Low)			
	1234	04D2h	Retry monitor 2 Power ON time (High)	R	0 ~ 1000000	1hr
	1235	04D3h	(Low)			
	1236	04D4h	Retry monitor 2 Absolute time (year, month)	R	00 - 99 (BCD code) 01 - 12 (BCD code)	1 1
	1237	04D5h	Retry monitor 2 Absolute time (day, day of the week)	R	01 - 31 (BCD code) 00 - 06 (BCD code)	1 1
1238	04D6h	Retry monitor 2 Absolute time (hour, minute)	R	00 - 23 (BCD code) 00 - 59 (BCD code)	1 1	

Function Code	Register No. (decimal)	Register No. (hexadecimal)	Function Name	R/W	Monitor Content and Setting Item	Data Resolution / Unit
Retry monitor (dE-33)	1241	04D9h	Retry monitor 3 Factor	R	1 ~ 255	1
	1242	04DAh	Retry monitor 3 Output frequency (High)	R	-59000 ~ 59000	0.01Hz
	1243	04DBh	(with sign) (Low)			
	1244	04DCh	Retry monitor 3 Output current	R	0 ~ 65535	0.01A
	1245	04DDh	Retry monitor 3 P-N DC voltage	R	0 ~ 10000	0.1Vdc
	1246	04DEh	Retry monitor 3 Inverter state	R	0 ~ 8	1
	1247	04DFh	Retry monitor 3 LAD state	R	0 ~ 5	1
	1248	04E0h	Retry monitor 3 INV control mode	R	0 ~ 11	1
	1249	04E1h	Retry monitor 3 Limit state	R	0 ~ 6	1
	1250	04E2h	Retry monitor 3 Special state	R	0 ~ 6	1
	1252	04E4h	Retry monitor 3 RUN time (High)	R	0 ~ 1000000	1hr
	1253	04E5h	(Low)			
	1254	04E6h	Retry monitor 3 Power ON time (High)	R	0 ~ 1000000	1hr
	1255	04E7h	(Low)			
	1256	04E8h	Retry monitor 3 Absolute time (year, month)	R	00 - 99 (BCD code) 01 - 12 (BCD code)	1 1
1257	04E9h	Retry monitor 3 Absolute time (day, day of the week)	R	01 - 31 (BCD code) 00 - 06 (BCD code)	1 1	
1258	04EAh	Retry monitor 3 Absolute time (hour, minute)	R	00 - 23 (BCD code) 00 - 59 (BCD code)	1 1	
Retry monitor (dE-34)	1261	04EDh	Retry monitor 4 Factor	R	1 ~ 255	1
	1262	04EEh	Retry monitor 4 Output frequency (High)	R	-59000 ~ 59000	0.01Hz
	1263	04EFh	(with sign) (Low)			
	1264	04F0h	Retry monitor 4 Output current	R	0 ~ 65535	0.01A
	1265	04F1h	Retry monitor 4 P-N DC voltage	R	0 ~ 10000	0.1Vdc
	1266	04F2h	Retry monitor 4 Inverter state	R	0 ~ 8	1
	1267	04F3h	Retry monitor 4 LAD state	R	0 ~ 5	1
	1268	04F4h	Retry monitor 4 INV control mode	R	0 ~ 11	1
	1269	04F5h	Retry monitor 4 Limit state	R	0 ~ 6	1
	1270	04F6h	Retry monitor 4 Special state	R	0 ~ 6	1
	1272	04F8h	Retry monitor 4 RUN time (High)	R	0 ~ 1000000	1hr
	1273	04F9h	(Low)			
	1274	04FAh	Retry monitor 4 Power ON time (High)	R	0 ~ 1000000	1hr
	1275	04FBh	(Low)			
	1276	04FCh	Retry monitor 4 Absolute time (year, month)	R	00 - 99 (BCD code) 01 - 12 (BCD code)	1 1
1277	04FDh	Retry monitor 4 Absolute time (day, day of the week)	R	01 - 31 (BCD code) 00 - 06 (BCD code)	1 1	
1278	04FEh	Retry monitor 4 Absolute time (hour, minute)	R	00 - 23 (BCD code) 00 - 59 (BCD code)	1 1	



Function Code	Register No. (decimal)	Register No. (hexadecimal)	Function Name	R/W	Monitor Content and Setting Item	Data Resolution / Unit
Retry monitor (dE-35)	1281	0501h	Retry monitor 5 Factor	R	1 ~ 255	1
	1282	0502h	Retry monitor 5 Output frequency (High)	R	-59000 ~ 59000	0.01Hz
	1283	0503h	(with sign) (Low)			
	1284	0504h	Retry monitor 5 Output current	R	0 ~ 65535	0.01A
	1285	0505h	Retry monitor 5 P-N DC voltage	R	0 ~ 10000	0.1Vdc
	1286	0506h	Retry monitor 5 Inverter state	R	0 ~ 8	1
	1287	0507h	Retry monitor 5 LAD state	R	0 ~ 5	1
	1288	0508h	Retry monitor 5 INV control mode	R	0 ~ 11	1
	1289	0509h	Retry monitor 5 Limit state	R	0 ~ 6	1
	1290	050Ah	Retry monitor 5 Special state	R	0 ~ 6	1
	1292	050Ch	Retry monitor 5 RUN time (High)	R	0 ~ 1000000	1hr
	1293	050Dh	(Low)			
	1294	050Eh	Retry monitor 5 Power ON time (High)	R	0 ~ 1000000	1hr
	1295	050Fh	(Low)			
	1296	0510h	Retry monitor 5 Absolute time (year, month)	R	00 - 99 (BCD code) 01 - 12 (BCD code)	1 1
1297	0511h	Retry monitor 5 Absolute time (day, day of the week)	R	01 - 31 (BCD code) 00 - 06 (BCD code)	1 1	
1298	0512h	Retry monitor 5 Absolute time (hour, minute)	R	00 - 23 (BCD code) 00 - 59 (BCD code)	1 1	
Retry monitor (dE-36)	1301	0515h	Retry monitor 6 Factor	R	1 ~ 255	1
	1302	0516h	Retry monitor 6 Output frequency (High)	R	-59000 ~ 59000	0.01Hz
	1303	0517h	(with sign) (Low)			
	1304	0518h	Retry monitor 6 Output current	R	0 ~ 65535	0.01A
	1305	0519h	Retry monitor 6 P-N DC voltage	R	0 ~ 10000	0.1Vdc
	1306	051Ah	Retry monitor 6 Inverter state	R	0 ~ 8	1
	1307	051Bh	Retry monitor 6 LAD state	R	0 ~ 5	1
	1308	051Ch	Retry monitor 6 INV control mode	R	0 ~ 11	1
	1309	051Dh	Retry monitor 6 Limit state	R	0 ~ 6	1
	1310	051Eh	Retry monitor 6 Special state	R	0 ~ 6	1
	1312	0520h	Retry monitor 6 RUN time (High)	R	0 ~ 1000000	1hr
	1313	0521h	(Low)			
	1314	0522h	Retry monitor 6 Power ON time (High)	R	0 ~ 1000000	1hr
	1315	0523h	(Low)			
	1316	0524h	Retry monitor 6 Absolute time (year, month)	R	00 - 99 (BCD code) 01 - 12 (BCD code)	1 1
1317	0525h	Retry monitor 6 Absolute time (day, day of the week)	R	01 - 31 (BCD code) 00 - 06 (BCD code)	1 1	
1318	0526h	Retry monitor 6 Absolute time (hour, minute)	R	00 - 23 (BCD code) 00 - 59 (BCD code)	1 1	

Function Code	Register No. (decimal)	Register No. (hexadecimal)	Function Name	R/W	Monitor Content and Setting Item	Data Resolution / Unit
Retry monitor (dE-37)	1321	0529h	Retry monitor 7 Factor	R	1 ~ 255	1
	1322	052Ah	Retry monitor 7 Output frequency (High)	R	-59000 ~ 59000	0.01Hz
	1323	052Bh	(with sign) (Low)			
	1324	052Ch	Retry monitor 7 Output current	R	0 ~ 65535	0.01A
	1325	052Dh	Retry monitor 7 P-N DC voltage	R	0 ~ 10000	0.1Vdc
	1326	052Eh	Retry monitor 7 Inverter state	R	0 ~ 8	1
	1327	052Fh	Retry monitor 7 LAD state	R	0 ~ 5	1
	1328	0530h	Retry monitor 7 INV control mode	R	0 ~ 11	1
	1329	0531h	Retry monitor 7 Limit state	R	0 ~ 6	1
	1330	0532h	Retry monitor 7 Special state	R	0 ~ 6	1
	1332	0534h	Retry monitor 7 RUN time (High)	R	0 ~ 1000000	1hr
	1333	0535h	(Low)			
	1334	0536h	Retry monitor 7 Power ON time (High)	R	0 ~ 1000000	1hr
	1335	0537h	(Low)			
	1336	0538h	Retry monitor 7 Absolute time (year, month)	R	00 - 99 (BCD code) 01 - 12 (BCD code)	1 1
	1337	0539h	Retry monitor 7 Absolute time (day, day of the week)	R	01 - 31 (BCD code) 00 - 06 (BCD code)	1 1
1338	053Ah	Retry monitor 7 Absolute time (hour, minute)	R	00 - 23 (BCD code) 00 - 59 (BCD code)	1 1	
Retry monitor (dE-38)	1341	053Dh	Retry monitor 8 Factor	R	1 ~ 255	1
	1342	053Eh	Retry monitor 8 Output frequency (High)	R	-59000 ~ 59000	0.01Hz
	1343	053Fh	(with sign) (Low)			
	1344	0540h	Retry monitor 8 Output current	R	0 ~ 65535	0.01A
	1345	0541h	Retry monitor 8 P-N DC voltage	R	0 ~ 10000	0.1Vdc
	1346	0542h	Retry monitor 8 Inverter state	R	0 ~ 8	1
	1347	0543h	Retry monitor 8 LAD state	R	0 ~ 5	1
	1348	0544h	Retry monitor 8 INV control mode	R	0 ~ 11	1
	1349	0545h	Retry monitor 8 Limit state	R	0 ~ 6	1
	1350	0546h	Retry monitor 8 Special state	R	0 ~ 6	1
	1352	0548h	Retry monitor 8 RUN time (High)	R	0 ~ 1000000	1hr
	1353	0549h	(Low)			
	1354	054Ah	Retry monitor 8 Power ON time (High)	R	0 ~ 1000000	1hr
	1355	054Bh	(Low)			
	1356	054Ch	Retry monitor 8 Absolute time (year, month)	R	00 - 99 (BCD code) 01 - 12 (BCD code)	1 1
	1357	054Dh	Retry monitor 8 Absolute time (day, day of the week)	R	01 - 31 (BCD code) 00 - 06 (BCD code)	1 1
1358	054Eh	Retry monitor 8 Absolute time (hour, minute)	R	00 - 23 (BCD code) 00 - 59 (BCD code)	1 1	

Function Code	Register No. (decimal)	Register No. (hexadecimal)	Function Name	R/W	Monitor Content and Setting Item	Data Resolution / Unit
Retry monitor (dE-39)	1361	0551h	Retry monitor 9 Factor	R	1 ~ 255	1
	1362	0552h	Retry monitor 9 Output frequency (High)	R	-59000 ~ 59000	0.01Hz
	1363	0553h	(with sign) (Low)			
	1364	0554h	Retry monitor 9 Output current	R	0 ~ 65535	0.01A
	1365	0555h	Retry monitor 9 P-N DC voltage	R	0 ~ 10000	0.1Vdc
	1366	0556h	Retry monitor 9 Inverter state	R	0 ~ 8	1
	1367	0557h	Retry monitor 9 LAD state	R	0 ~ 5	1
	1368	0558h	Retry monitor 9 INV control mode	R	0 ~ 11	1
	1369	0559h	Retry monitor 9 Limit state	R	0 ~ 6	1
	1370	055Ah	Retry monitor 9 Special state	R	0 ~ 6	1
	1372	055Ch	Retry monitor 9 RUN time (High)	R	0 ~ 1000000	1hr
	1373	055Dh	(Low)			
	1374	055Eh	Retry monitor 9 Power ON time (High)	R	0 ~ 1000000	1hr
	1375	055Fh	(Low)			
	1376	0560h	Retry monitor 9 Absolute time (year, month)	R	00 - 99 (BCD code) 01 - 12 (BCD code)	1 1
1377	0561h	Retry monitor 9 Absolute time (day, day of the week)	R	01 - 31 (BCD code) 00 - 06 (BCD code)	1 1	
1378	0562h	Retry monitor 9 Absolute time (hour, minute)	R	00 - 23 (BCD code) 00 - 59 (BCD code)	1 1	
Retry monitor (dE-40)	1381	0565h	Retry monitor 10 Factor	R	1 ~ 255	1
	1382	0566h	Retry monitor 10 Output frequency (High)	R	-59000 ~ 59000	0.01Hz
	1383	0567h	(with sign) (Low)			
	1384	0568h	Retry monitor 10 Output current	R	0 ~ 65535	0.01A
	1385	0569h	Retry monitor 10 P-N DC voltage	R	0 ~ 10000	0.1Vdc
	1386	056Ah	Retry monitor 10 Inverter state	R	0 ~ 8	1
	1387	056Bh	Retry monitor 10 LAD state	R	0 ~ 5	1
	1388	056Ch	Retry monitor 10 INV control mode	R	0 ~ 11	1
	1389	056Dh	Retry monitor 10 Limit state	R	0 ~ 6	1
	1390	056Eh	Retry monitor 10 Special state	R	0 ~ 6	1
	1392	0570h	Retry monitor 10 RUN time (High)	R	0 ~ 1000000	1hr
	1393	0571h	(Low)			
	1394	0572h	Retry monitor 10 Power ON time (High)	R	0 ~ 1000000	1hr
	1395	0573h	(Low)			
	1396	0574h	Retry monitor 10 Absolute time (year, month)	R	00 - 99 (BCD code) 01 - 12 (BCD code)	1 1
1397	0575h	Retry monitor 10 Absolute time (day, day of the week)	R	01 - 31 (BCD code) 00 - 06 (BCD code)	1 1	
1398	0576h	Retry monitor 10 Absolute time (hour, minute)	R	00 - 23 (BCD code) 00 - 59 (BCD code)	1 1	

(Warning)

Function Code	Register No. (decimal)	Register No. (hexadecimal)	Function Name	R/W	Monitor Content and Setting Item	Data Resolution / Unit
dE-50	1500	05DCh	Warning monitor	R	0 ~ 65535	1

(Writing, recalculation register)

Function Code	Register No. (decimal)	Register No. (hexadecimal)	Function Name	R/W	Monitor Content and Setting Item	Data Resolution / Unit
-	9000	2328h	ENTER instruction (Writing to Data Flash)	W	01: writing all parameters	1
-	9002	232Ah	1 register writing mode	W	01: enabled	1
-	9010	2332h	Motor constant recalculation (motor constant standard data not to be developed)	W	01: enabled	1

(Items other than parameter)

Function Code	Register No. (decimal)	Register No. (hexadecimal)	Function Name	R/W	Monitor Content and Setting Item	Data Resolution / Unit
-	10502	2906h	RS485 Set frequency (High)	R/W	-59000 to + 59000 (setting range is not the same with Ver1.xx.)	0.01Hz
-	10503	2907h	(Signed) (Common to main speed and auxiliary speed) (Low)			
-	10526	291Eh	RS485 Torque command	R/W	-5000 ~ 5000	0.1%
-	10530	2922h	RS485 Torque bias	R/W	-5000 ~ 5000	0.1%
-	10534	2926h	RS485 Torque control speed limit value (for normal rotation)	R/W	0 ~ 59000	0.01Hz
-	10535	2927h	RS485 Torque control speed limit value (for reverse rotation)	R/W	0 ~ 59000	0.01Hz
-	10546	2932h	RS485 PID target value (High)	R/W	-10000 ~ 10000	0.01%
-	10547	2933h	(Low)			
-	10554	293Ah	RS485 PID feedback data (High)	R/W	-10000 ~ 10000	0.01%
-	10555	293Bh	(Low)			
-	10566	2946h	RS485 Torque limit	R/W	0 ~ 5000	0.1%
-	16053	3EB5h	Output terminal function option output (OPO output)	R/W	0 ~ 0x7F	1
-	16060	3EBCh	Coil data 0 (coil No. 0001h - 000Fh)	R/W	0 ~ 0xFFFF	1
-	16061	3EBDh	Coil data 1 (coil No. 0010h - 001Fh)	R	0 ~ 0xFFFF	1
-	16062	3EBEh	Coil data 2 (coil No. 0020h - 002Fh)	R	0 ~ 0xFFFF	1
-	16063	3EBFh	Coil data 3 (coil No. 0030h - 003Fh)	R	0 ~ 0xFFFF	1
-	16064	3EC0h	Coil data 4 (coil No. 0040h - 004Fh)	R	0 ~ 0xFFFF	1

(Monitor + setting parameter (Code-F))

Function Code	Register No. (decimal)	Register No. (hexadecimal)	Function Name	R/W	Monitor Content and Setting Item	Data Resolution / Unit
FA-01	11001	2AF9h	Main speed command (monitor + setting)	R/W	0 ~ 59000	0.01Hz
<b>FA-02</b>	11002	2AFAh	Auxiliary speed command (monitor + setting) (High)	R/W	-59000 to +59000 (monitor) 0 to 59000 (setting) (Register No. and monitor range are not the same with Ver1.xx.)	0.01Hz
<b>(FA-03)</b>	11003	2AFBh	(Low)			
FA-10	11010	2B02h	Acceleration time (monitor + setting) (High)	R/W	0 ~ 360000	0.01s
<b>(FA-11)</b>	11011	2B03h	(Low)			
FA-12	11012	2B04h	Deceleration time (monitor + setting) (High)	R/W	0 ~ 360000	0.01s
<b>(FA-13)</b>	11013	2B05h	(Low)			
FA-15	11015	2B07h	Torque command monitor (monitor + setting)	R/W	-5000 ~ 5000	0.1%
FA-16	11016	2B08h	Torque bias monitor (monitor + setting)	R/W	-5000 ~ 5000	0.1%
<b>FA-20</b>	11020	2B0Ch	Position command monitor (monitor + setting) (High)	R/W	-268435455 ~ 268435455 In high resolution mode: -1073741823 to 1073741823	1
<b>(FA-21)</b>	11021	2B0Dh	(Low)			
FA-30	11030	2B16h	PID1 target value 1 (monitor + setting) (High)	R/W	-10000 ~ 10000	Per AH-06 setting
<b>(FA-31)</b>	11031	2B17h	(Low)			
FA-32	11032	2B18h	PID1 target value 2 (monitor + setting) (High)	R/W	-10000 ~ 10000	Per AH-06 setting
<b>(FA-33)</b>	11033	2B19h	(Low)			
<b>FA-34</b>	11034	2B1Ah	PID1 target value 3 (monitor + setting) (High)	R/W	-10000 ~ 10000	Per AH-06 setting
<b>(FA-35)</b>	11035	2B1Bh	(Low)			
FA-36	11036	2B1Ch	PID2 target value (monitor + setting) (High)	R/W	-10000 ~ 10000	Per AJ-06 setting
<b>(FA-37)</b>	11037	2B1Dh	(Low)			
<b>FA-38</b>	11038	2B1Eh	PID3 target value (monitor + setting) (High)	R/W	-10000 ~ 10000	Per AJ-26 setting
<b>(FA-39)</b>	11039	2B1Fh	(Low)			
<b>FA-40</b>	11040	2B20h	PID4 target value (monitor + setting) (High)	R/W	-10000 ~ 10000	Per AJ-46 setting
<b>(FA-41)</b>	11041	2B21h	(Low)			

(Setting parameter (Code-A, b, C, H, o, P, U))

Function Code	Register No. (decimal)	Register No. (hexadecimal)	Function Name	R/W	Monitor Content and Setting Item	Data Resolution / Unit
AA101	12001	2EE1h	First main speed command selection	R/W	1 ~ 16	1
AA102	12002	2EE2h	First auxiliary speed command selection	R/W	0 ~ 16	1
AA104	12004	2EE4h	First auxiliary speed setting	R/W	0 ~ 59000	0.01Hz
AA105	12005	2EE5h	First operator selection	R/W	0 ~ 3	1
AA106	12006	2EE6h	First additional frequency setting (High)	R/W	-59000 ~ 59000	0.01Hz
(AA107)	12007	2EE7h	(SET-POINT) (Low)			
AA111	12011	2EEBh	First operation command selection	R/W	0 ~ 6	1
AA-12	12012	2EECh	RUN key direction selection	R/W	0 ~ 1	1
AA-13	12013	2EEDh	STOP key selection	R/W	0 ~ 2	1
AA114	12014	2EEeh	First operation direction limit selection	R/W	0 ~ 2	1
AA115	12015	2EEFh	First stop mode selection	R/W	0 ~ 1	1
AA121	12021	2EF5h	First control mode	R/W	0 ~ 12	1
<b>AA123</b>	12023	2EF7h	First vector control mode selection	R/W	0 ~ 3	1
AA201	22001	55F1h	Second main speed command selection	R/W	1 ~ 16	1
AA202	22002	55F2h	Second auxiliary speed command selection	R/W	0 ~ 16	1
AA204	22004	55F4h	Second auxiliary speed setting	R/W	0 ~ 59000	0.01Hz
AA205	22005	55F5h	Second operator selection	R/W	0 ~ 3	1
AA206	22006	55F6h	Second additional frequency setting (High)	R/W	-59000 ~ 59000	0.01Hz
(AA207)	22007	55F7h	(SET-POINT) (Low)			
AA211	22011	55FBh	Second operation command selection	R/W	0 ~ 6	1
AA214	22014	55FEh	Second operation direction limit selection	R/W	0 ~ 2	1
AA215	22015	55FFh	Second stop mode selection	R/W	0 ~ 1	1
AA221	22021	5605h	Second control mode	R/W	0 ~ 11	1
<b>AA223</b>	22023	5607h	Second vector control mode selection	R/W	0 ~ 3	1
Ab-01	12101	2F45h	Frequency conversion coefficient	R/W	1 ~ 10000	0.01
Ab-03	12103	2F47h	Multi-step speed selection	R/W	0 ~ 1	1
Ab110	12110	2F4Eh	0th speed of the 1st multi-step speed	R/W	0 ~ 59000	0.01Hz
Ab-11	12111	2F4Fh	1st speed of the multi-step speed	R/W	0 ~ 59000	0.01Hz
Ab-12	12112	2F50h	2nd speed of the multi-step speed	R/W	0 ~ 59000	0.01Hz
Ab-13	12113	2F51h	3rd speed of the multi-step speed	R/W	0 ~ 59000	0.01Hz
Ab-14	12114	2F52h	4th speed of the multi-step speed	R/W	0 ~ 59000	0.01Hz
Ab-15	12115	2F53h	5th speed of the multi-step speed	R/W	0 ~ 59000	0.01Hz
Ab-16	12116	2F54h	6th speed of the multi-step speed	R/W	0 ~ 59000	0.01Hz
Ab-17	12117	2F55h	7th speed of the multi-step speed	R/W	0 ~ 59000	0.01Hz
Ab-18	12118	2F56h	8th speed of the multi-step speed	R/W	0 ~ 59000	0.01Hz
Ab-19	12119	2F57h	9th speed of the multi-step speed	R/W	0 ~ 59000	0.01Hz
Ab-20	12120	2F58h	10th speed of the multi-step speed	R/W	0 ~ 59000	0.01Hz
Ab-21	12121	2F59h	11th speed of the multi-step speed	R/W	0 ~ 59000	0.01Hz
Ab-22	12122	2F5Ah	12th speed of the multi-step speed	R/W	0 ~ 59000	0.01Hz
Ab-23	12123	2F5Bh	13th speed of the multi-step speed	R/W	0 ~ 59000	0.01Hz
Ab-24	12124	2F5Ch	14th speed of the multi-step speed	R/W	0 ~ 59000	0.01Hz
Ab-25	12125	2F5Dh	15th speed of the multi-step speed	R/W	0 ~ 59000	0.01Hz
Ab210	22110	565Eh	0th speed of the 2nd multi-step speed	R/W	0 ~ 59000	0.01Hz

Function Code	Register No. (decimal)	Register No. (hexadecimal)	Function Name	R/W	Monitor Content and Setting Item	Data Resolution / Unit
AC-01	12201	2FA9h	Acceleration or deceleration time input type	R/W	0 ~ 4	1
AC-02	12202	2FAAh	Multi-stage acceleration or deceleration selection	R/W	0 ~ 1	1
AC-03	12203	2FABh	Acceleration pattern selection	R/W	0 ~ 4	1
AC-04	12204	2FACH	Deceleration pattern selection	R/W	0 ~ 4	1
AC-05	12205	2FADh	Acceleration curve constant (S, U, reverse U)	R/W	1 ~ 10	1
AC-06	12206	2FAEh	Deceleration curve constant (S, U, reverse U)	R/W	1 ~ 10	1
AC-08	12208	2FB0h	Curvature 1 for EL-S-shaped acceleration	R/W	0 ~ 100	1%
AC-09	12209	2FB1h	Curvature 2 for EL-S-shaped acceleration	R/W	0 ~ 100	1%
AC-10	12210	2FB2h	Curvature 1 for EL-S-shaped deceleration	R/W	0 ~ 100	1%
AC-11	12211	2FB3h	Curvature 2 for EL-S-shaped deceleration	R/W	0 ~ 100	1%
AC115	12215	2FB7h	First 2-stage acceleration or deceleration selection	R/W	0 ~ 2	1
AC116	12216	2FB8h	First 2-stage acceleration frequency	R/W	0 ~ 59000	0.01Hz
AC117	12217	2FB9h	First 2-stage deceleration frequency	R/W	0 ~ 59000	0.01Hz
AC120	12220	2FBCh	First acceleration time 1 (High)	R/W	0 ~ 360000	0.01s
(AC121)	12221	2FBDh	(Low)			
AC122	12222	2FBEh	First deceleration time 1 (High)	R/W	0 ~ 360000	0.01s
(AC123)	12223	2FBFh	(Low)			
AC124	12224	2FC0h	First acceleration time 2 (High)	R/W	0 ~ 360000	0.01s
(AC125)	12225	2FC1h	(Low)			
AC126	12226	2FC2h	First deceleration time 2 (High)	R/W	0 ~ 360000	0.01s
(AC127)	12227	2FC3h	(High)			
AC-30	12230	2FC6h	Acceleration time for multi-speed 1st speed (High)	R/W	0 ~ 360000	0.01s
(AC-31)	12231	2FC7h	(Low)			
AC-32	12232	2FC8h	Deceleration time for multi-speed 1st speed (High)	R/W	0 ~ 360000	0.01s
(AC-33)	12233	2FC9h	(Low)			
AC-34	12234	2FCAh	Acceleration time for multi-speed 2nd speed (High)	R/W	0 ~ 360000	0.01s
(AC-35)	12235	2FCBh	(Low)			
AC-36	12236	2FCCh	Deceleration time for multi-speed 2nd speed (High)	R/W	0 ~ 360000	0.01s
(AC-37)	12237	2FCDh	(Low)			
AC-38	12238	2FCEh	Acceleration time for multi-speed 3rd speed (High)	R/W	0 ~ 360000	0.01s
(AC-39)	12239	2FCFh	(Low)			
AC-40	12240	2FD0h	Deceleration time for multi-speed 3rd speed (High)	R/W	0 ~ 360000	0.01s
(AC-41)	12241	2FD1h	(Low)			
AC-42	12242	2FD2h	Acceleration time for multi-speed 4th speed (High)	R/W	0 ~ 360000	0.01s
(AC-43)	12243	2FD3h	(Low)			
AC-44	12244	2FD4h	Deceleration time for multi-speed 4th speed (High)	R/W	0 ~ 360000	0.01s
(AC-45)	12245	2FD5h	(Low)			
AC-46	12246	2FD6h	Acceleration time for multi-speed 5th speed (High)	R/W	0 ~ 360000	0.01s
(AC-47)	12247	2FD7h	(Low)			
AC-48	12248	2FD8h	Deceleration time for multi-speed 5th speed (High)	R/W	0 ~ 360000	0.01s
(AC-49)	12249	2FD9h	(Low)			
AC-50	12250	2FDAh	Acceleration time for multi-speed 6th speed (High)	R/W	0 ~ 360000	0.01s
(AC-51)	12251	2FDBh	(Low)			
AC-52	12252	2FDCh	Deceleration time for multi-speed 6th speed (High)	R/W	0 ~ 360000	0.01s
(AC-53)	12253	2FDDh	(Low)			

Function Code	Register No. (decimal)	Register No. (hexadecimal)	Function Name	R/W	Monitor Content and Setting Item	Data Resolution / Unit
AC-54	12254	2FDEh	Acceleration time for multi-speed 7th speed (High)	R/W	0 ~ 360000	0.01s
(AC-55)	12255	2FDFh	(Low)			
AC-56	12256	2FE0h	Deceleration time for multi-speed 7th speed (High)	R/W	0 ~ 360000	0.01s
(AC-57)	12257	2FE1h	(Low)			
AC-58	12258	2FE2h	Acceleration time for multi-speed 8th speed (High)	R/W	0 ~ 360000	0.01s
(AC-59)	12259	2FE3h	(Low)			
AC-60	12260	2FE4h	Deceleration time for multi-speed 8th speed (High)	R/W	0 ~ 360000	0.01s
(AC-61)	12261	2FE5h	(Low)			
AC-62	12262	2FE6h	Acceleration time for multi-speed 9th speed (High)	R/W	0 ~ 360000	0.01s
(AC-63)	12263	2FE7h	(Low)			
AC-64	12264	2FE8h	Deceleration time for multi-speed 9th speed (High)	R/W	0 ~ 360000	0.01s
(AC-65)	12265	2FE9h	(Low)			
AC-66	12266	2FEAh	Acceleration time for multi-speed 10th speed (High)	R/W	0 ~ 360000	0.01s
(AC-67)	12267	2FEBh	(Low)			
AC-68	12268	2FEC h	Deceleration time for multi-speed 10th speed (High)	R/W	0 ~ 360000	0.01s
(AC-69)	12269	2FEDh	(Low)			
AC-70	12270	2FEEh	Acceleration time for multi-speed 11th speed (High)	R/W	0 ~ 360000	0.01s
(AC-71)	12271	2FEFh	(Low)			
AC-72	12272	2FF0h	Deceleration time for multi-speed 11th speed (High)	R/W	0 ~ 360000	0.01s
(AC-73)	12273	2FF1h	(Low)			
AC-74	12274	2FF2h	Acceleration time for multi-speed 12th speed (High)	R/W	0 ~ 360000	0.01s
(AC-75)	12275	2FF3h	(Low)			
AC-76	12276	2FF4h	Deceleration time for multi-speed 12th speed (High)	R/W	0 ~ 360000	0.01s
(AC-77)	12277	2FF5h	(Low)			
AC-78	12278	2FF6h	Acceleration time for multi-speed 13th speed (High)	R/W	0 ~ 360000	0.01s
(AC-79)	12279	2FF7h	(Low)			
AC-80	12280	2FF8h	Deceleration time for multi-speed 13th speed (High)	R/W	0 ~ 360000	0.01s
(AC-81)	12281	2FF9h	(Low)			
AC-82	12282	2FFAh	Acceleration time for multi-speed 14th speed (High)	R/W	0 ~ 360000	0.01s
(AC-83)	12283	2FFBh	(Low)			
AC-84	12284	2FFCh	Deceleration time for multi-speed 14th speed (High)	R/W	0 ~ 360000	0.01s
(AC-85)	12285	2FFDh	(Low)			
AC-86	12286	2FFEh	Acceleration time for multi-speed 15th speed (High)	R/W	0 ~ 360000	0.01s
(AC-87)	12287	2FFFh	(Low)			
AC-88	12288	3000h	Deceleration time for multi-speed 15th speed (High)	R/W	0 ~ 360000	0.01s
(AC-89)	12289	3001h	(Low)			
AC215	22215	56C7h	Second 2-stage acceleration or deceleration selection	R/W	0 ~ 2	1
AC216	22216	56C8h	Second 2-stage acceleration frequency	R/W	0 ~ 59000	0.01Hz
AC217	22217	56C9h	Second 2-stage deceleration frequency	R/W	0 ~ 59000	0.01Hz
AC220	22220	56CCh	Second acceleration time 1 (High)	R/W	0 ~ 360000	0.01s
(AC221)	22221	56CDh	(Low)			
AC222	22222	56Ceh	Second deceleration time 1 (High)	R/W	0 ~ 360000	0.01s
(AC223)	22223	56CFh	(Low)			
AC224	22224	56D0h	Second acceleration time 2 (High)	R/W	0 ~ 360000	0.01s
(AC225)	22225	56D1h	(Low)			
AC226	22226	56D2h	Second deceleration time 2 (High)	R/W	0 ~ 360000	0.01s
(AC227)	22227	56D3h	(Low)			



Function Code	Register No. (decimal)	Register No. (hexadecimal)	Function Name	R/W	Monitor Content and Setting Item	Data Resolution / Unit
Ad-01	12301	300Dh	Torque command input selection	R/W	1 ~ 15	1
Ad-02	12302	300Eh	Torque command setting	R/W	-5000 ~ 5000	0.1%
Ad-03	12303	300Fh	Torque command polarity selection	R/W	0 ~ 1	1
Ad-04	12304	3010h	Speed/torque control switch time	R/W	0 ~ 1000	1ms
Ad-11	12311	3017h	Torque bias input selection	R/W	0 ~ 15	1
Ad-12	12312	3018h	Torque bias setting	R/W	-5000 ~ 5000	0.1%
Ad-13	12313	3019h	Torque bias polarity selection	R/W	0 ~ 1	1
Ad-14	12314	301Ah	Enable torque bias terminal [TBS] selection	R/W	0 ~ 1	1
<b>Ad-40</b>	12340	3034h	Torque control speed limit value input selection	R/W	1 ~ 13	1
Ad-41	12341	3035h	Torque control speed limit value (for normal rotation)	R/W	0 ~ 59000	0.01Hz
Ad-42	12342	3036h	Torque control speed limit value (for reverse rotation)	R/W	0 ~ 59000	0.01Hz
<b>AE-01</b>	12401	3071h	Electronic gear installation position selection	R/W	0 ~ 1	1
<b>AE-02</b>	12402	3072h	Electronic gear ratio's numerator	R/W	1 ~ 10000	1
<b>AE-03</b>	12403	3073h	Electronic gear ratio's denominator	R/W	1 ~ 10000	1
<b>AE-04</b>	12404	3074h	Positioning completion range setting	R/W	0 ~ 10000	1pls
<b>AE-05</b>	12405	3075h	Positioning completion delay time setting	R/W	0 ~ 1000	0.01s
<b>AE-06</b>	12406	3076h	Position control feed forward	R/W	0 ~ 65535	0.01
<b>AE-07</b>	12407	3077h	Position loop gain	R/W	0 ~ 10000	0.01
<b>AE-08</b>	12408	3078h	Position bias setting	R/W	-2048 ~ 2048	1pls
<b>AE-10</b>	12410	307Ah	Orientation stop position input destination selection	R/W	0 ~ 3	1
<b>AE-11</b>	12411	307Bh	Orientation stop position input destination selection	R/W	0 ~ 4095	1
<b>AE-12</b>	12412	307Ch	Orientation speed setting	R/W	0 ~ 12000	0.01Hz
<b>AE-13</b>	12413	307Dh	Orientation direction setting	R/W	0 ~ 1	1
<b>AE-20</b>	12420	3084h	Position command 0 (High)	R/W	-268435455 ~ 268435455 In high resolution mode: -1073741823 to 1073741823	1pls
<b>(AE-21)</b>	12421	3085h	(Low)			
<b>AE-22</b>	12422	3086h	Position command 1 (High)	R/W	-268435455 ~ 268435455 In high resolution mode: -1073741823 to 1073741823	1pls
<b>(AE-23)</b>	12423	3087h	(Low)			
<b>AE-24</b>	12424	3088h	Position command 2 (High)	R/W	-268435455 ~ 268435455 In high resolution mode: -1073741823 to 1073741823	1pls
<b>(AE-25)</b>	12425	3089h	(Low)			
<b>AE-26</b>	12426	308Ah	Position command 3 (High)	R/W	-268435455 ~ 268435455 In high resolution mode: -1073741823 to 1073741823	1pls
<b>(AE-27)</b>	12427	308Bh	(Low)			
<b>AE-28</b>	12428	308Ch	Position command 4 (High)	R/W	-268435455 ~ 268435455 In high resolution mode: -1073741823 to 1073741823	1pls
<b>(AE-29)</b>	12429	308Dh	(Low)			
<b>AE-30</b>	12430	308Eh	Position command 5 (High)	R/W	-268435455 ~ 268435455 In high resolution mode: -1073741823 to 1073741823	1pls
<b>(AE-31)</b>	12431	308Fh	(Low)			
<b>AE-32</b>	12432	3090h	Position command 6 (High)	R/W	-268435455 ~ 268435455 In high resolution mode: -1073741823 to 1073741823	1pls
<b>(AE-33)</b>	12433	3091h	(Low)			
<b>AE-34</b>	12434	3092h	Position command 7 (High)	R/W	-268435455 ~ 268435455 In high resolution mode: -1073741823 to 1073741823	1pls
<b>(AE-35)</b>	12435	3093h	(Low)			
<b>AE-36</b>	12436	3094h	Position command 8 (High)	R/W	-268435455 ~ 268435455 In high resolution mode: -1073741823 to 1073741823	1pls
<b>(AE-37)</b>	12437	3095h	(Low)			

Function Code	Register No. (decimal)	Register No. (hexadecimal)	Function Name	R/W	Monitor Content and Setting Item	Data Resolution / Unit
AE-38	12438	3096h	Position command 9 (High)	R/W	-268435455 ~ 268435455 In high resolution mode: -1073741823 to 1073741823	1pls
(AE-39)	12439	3097h	(Low)			
AE-40	12440	3098h	Position command 10 (High)	R/W	-268435455 ~ 268435455 In high resolution mode: -1073741823 to 1073741823	1pls
(AE-41)	12441	3099h	(Low)			
AE-42	12442	309Ah	Position command 11 (High)	R/W	-268435455 ~ 268435455 In high resolution mode: -1073741823 to 1073741823	1pls
(AE-43)	12443	309Bh	(Low)			
AE-44	12444	309Ch	Position command 12 (High)	R/W	-268435455 ~ 268435455 In high resolution mode: -1073741823 to 1073741823	1pls
(AE-45)	12445	309Dh	(Low)			
AE-46	12446	309Eh	Position command 13 (High)	R/W	-268435455 ~ 268435455 In high resolution mode: -1073741823 to 1073741823	1pls
(AE-47)	12447	309Fh	(Low)			
AE-48	12448	30A0h	Position command 14 (High)	R/W	-268435455 ~ 268435455 In high resolution mode: -1073741823 to 1073741823	1pls
(AE-49)	12449	30A1h	(Low)			
AE-50	12450	30A2h	Position command 15 (High)	R/W	-268435455 ~ 268435455 In high resolution mode: -1073741823 to 1073741823	1pls
(AE-51)	12451	30A3h	(Low)			
AE-52	12452	30A4h	Position range designation (forward rotation side) (High)	R/W	0 ~ 268435455 In high resolution mode: 0 to 1073741823	1pls
(AE-53)	12453	30A5h	(Low)			
AE-54	12454	30A6h	Position range designation (reverse rotation side) (High)	R/W	-268435455 ~ 0 In high resolution mode: -1073741823 to 0	1pls
(AE-55)	12455	30A7h	(Low)			
AE-56	12456	30A8h	Positioning mode selection	R/W	0 ~ 1	1
AE-60	12460	30Ach	Teaching selection	R/W	0 ~ 15	1
AE-61	12461	30Adh	Memorization of current position at power-off	R/W	0 ~ 1	1
AE-62	12462	30Aeh	Preset position data (High)	R/W	-268435455 ~ 268435455 In high resolution mode: -1073741823 to 1073741823	1pls
(AE-63)	12463	30Afh	(Low)			
AE-64	12464	30B0h	Gain for calculating the deceleration stop distance	R/W	5000 ~ 20000	0.01%
AE-65	12465	30B1h	Bias for calculating the deceleration stop distance	R/W	0 ~ 65535	0.01%
AE-66	12466	30B2h	APR control speed limit	R/W	0 ~ 10000	0.01%
AE-67	12467	30B3h	APR start speed	R/W	0 ~ 10000	0.01%
AE-70	12470	30B6h	Zero return mode selection	R/W	0 ~ 2	1
AE-71	12471	30B7h	Zero return direction selection	R/W	0 ~ 1	1
AE-72	12472	30B8h	Low speed zero return speed	R/W	0 ~ 1000	0.01Hz
AE-73	12473	30B9h	High speed zero return speed	R/W	0 ~ 59000	0.01Hz

Function Code	Register No. (decimal)	Register No. (hexadecimal)	Function Name	R/W	Monitor Content and Setting Item	Data Resolution / Unit
AF101	12501	30D5h	First DC braking selection	R/W	0 ~ 2	1
<b>AF102</b>	12502	30D6h	First braking mode selection	R/W	0 ~ 2	1
AF103	12503	30D7h	First DC braking frequency	R/W	0 ~ 59000	0.01Hz
AF104	12504	30D8h	First DC braking delay time	R/W	0 ~ 500	0.01s
AF105	12505	30D9h	First DC braking force at the time of the stop	R/W	0 ~ 100	1%
AF106	12506	30Dah	First DC braking time at the time of the stop	R/W	0 ~ 6000	0.01s
AF107	12507	30DBh	First DC braking trigger selection	R/W	0 ~ 1	1
AF108	12508	30DCh	First DC braking force at the start	R/W	0 ~ 100	1%
AF109	12509	30DDh	First DC braking time at the start	R/W	0 ~ 6000	0.01s
<b>AF120</b>	12520	30E8h	First contactor control selection	R/W	0 ~ 2	1
<b>AF121</b>	12521	30E9h	First start waiting time	R/W	0 ~ 200	0.01s
<b>AF122</b>	12522	30Eah	First contactor release delay time	R/W	0 ~ 200	0.01s
<b>AF123</b>	12523	30Ebh	First contactor check time	R/W	0 ~ 500	0.01s
AF130	12530	30F2h	First brake control selection	R/W	0 ~ 3	1
AF131	12531	30F3h	First brake release establishment waiting time (normal rotation side)	R/W	0 ~ 500	0.01s
AF132	12532	30F4h	First acceleration waiting time (normal rotation side)	R/W	0 ~ 500	0.01s
AF133	12533	30F5h	First stop waiting time (normal rotation side)	R/W	0 ~ 500	0.01s
AF134	12534	30F6h	First brake confirmation waiting time (normal rotation side)	R/W	0 ~ 500	0.01s
AF135	12535	30F7h	First brake release frequency (normal rotation side)	R/W	0 ~ 59000	0.01Hz
AF136	12536	30F8h	First brake release current (normal rotation side)	R/W	(0 to 2.00) * CTL rated current	0.1A
AF137	12537	30F9h	First brake apply frequency (normal rotation side)	R/W	0 ~ 59000	0.01Hz
AF138	12538	30Fah	First brake release establishment waiting time (reverse rotation side)	R/W	0 ~ 500	0.01s
AF139	12539	30FBh	First acceleration waiting time (reverse rotation side)	R/W	0 ~ 500	0.01s
AF140	12540	30FCh	First stop waiting time (reverse rotation side)	R/W	0 ~ 500	0.01s
AF141	12541	30FDh	First brake confirmation waiting time (reverse rotation side)	R/W	0 ~ 500	0.01s
AF142	12542	30Feh	First brake release frequency (reverse rotation side)	R/W	0 ~ 59000	0.01Hz
AF143	12543	30FFh	First brake release current (reverse rotation side)	R/W	(0 to 2.00) * CTL rated current	0.1A
AF144	12544	3100h	First brake apply frequency (reverse rotation side)	R/W	0 ~ 59000	0.01Hz
<b>AF150</b>	12550	3106h	First brake release delay time	R/W	0 ~ 200	0.01s
<b>AF151</b>	12551	3107h	First brake apply delay time	R/W	0 ~ 200	0.01s
<b>AF152</b>	12552	3108h	First brake check time	R/W	0 ~ 500	0.01s
<b>AF153</b>	12553	3109h	First servo lock time at start	R/W	0 ~ 1000	0.01s
<b>AF154</b>	12554	310Ah	First servo lock time at the time of the stop	R/W	0 ~ 1000	0.01s
AF201	22501	57E5h	Second DC braking selection	R/W	0 ~ 2	1
<b>AF202</b>	22502	57E6h	Second braking mode selection	R/W	0 ~ 2	1
AF203	22503	57E7h	Second DC braking frequency	R/W	0 ~ 59000	0.01Hz
AF204	22504	57E8h	Second DC braking delay time	R/W	0 ~ 500	0.01s
AF205	22505	57E9h	Second DC braking force at the time of the stop	R/W	0 ~ 100	1%
AF206	22506	57Eah	Second DC braking time at the time of the stop	R/W	0 ~ 6000	0.01s
AF207	22507	57Ebh	Second DC braking trigger selection	R/W	0 ~ 1	1
AF208	22508	57Ech	Second DC braking force at the start	R/W	0 ~ 100	1%
AF209	22509	57Edh	Second DC braking time at the start	R/W	0 ~ 6000	0.01s
<b>AF220</b>	22520	57F8h	Second contactor control selection	R/W	0 ~ 2	1
<b>AF221</b>	22521	57F9h	Second start waiting time	R/W	0 ~ 200	0.01s
<b>AF222</b>	22522	57Fah	Second contactor release delay time	R/W	0 ~ 200	0.01s
<b>AF223</b>	22523	57FBh	Second contactor check time	R/W	0 ~ 500	0.01s

Function Code	Register No. (decimal)	Register No. (hexadecimal)	Function Name	R/W	Monitor Content and Setting Item	Data Resolution / Unit
AF230	22530	5802h	Second brake control selection	R/W	0 ~ 3	1
AF231	22531	5803h	Second brake release establishment waiting time (normal rotation side)	R/W	0 ~ 500	0.01s
AF232	22532	5804h	Second acceleration waiting time (normal rotation side)	R/W	0 ~ 500	0.01s
AF233	22533	5805h	Second stop waiting time (normal rotation side)	R/W	0 ~ 500	0.01s
AF234	22534	5806h	Second brake confirmation waiting time (normal rotation side)	R/W	0 ~ 500	0.01s
AF235	22535	5807h	Second brake release frequency (normal rotation side)	R/W	0 ~ 59000	0.01Hz
AF236	22536	5808h	Second brake release current (normal rotation side)	R/W	(0 to 2.00) * CTL rated current	0.1A
AF237	22537	5809h	Second brake apply frequency (normal rotation side)	R/W	0 ~ 59000	0.01Hz
AF238	22538	580Ah	Second brake release establishment waiting time (reverse rotation side)	R/W	0 ~ 500	0.01s
AF239	22539	580Bh	Second acceleration waiting time (normal rotation side)	R/W	0 ~ 500	0.01s
AF240	22540	580Ch	Second stop waiting time (reverse rotation side)	R/W	0 ~ 500	0.01s
AF241	22541	580Dh	Second brake confirmation waiting time (reverse rotation side)	R/W	0 ~ 500	0.01s
AF242	22542	580Eh	Second brake release frequency (reverse rotation side)	R/W	0 ~ 59000	0.01Hz
AF243	22543	580Fh	Second brake release current (reverse rotation side)	R/W	(0 to 2.00) * CTL rated current	0.1A
AF244	22544	5810h	Second brake apply frequency (reverse rotation side)	R/W	0 ~ 59000	0.01Hz
<b>AF250</b>	22550	5816h	Second brake release delay time	R/W	0 ~ 200	0.01s
<b>AF251</b>	22551	5817h	Second brake apply delay time	R/W	0 ~ 200	0.01s
<b>AF252</b>	22552	5818h	Second brake check time	R/W	0 ~ 500	0.01s
<b>AF253</b>	22553	5819h	Second servo lock time at start	R/W	0 ~ 1000	0.01s
<b>AF254</b>	22554	581Ah	Second servo lock time at the time of the stop	R/W	0 ~ 1000	0.01s
AG101	12601	3139h	First jump frequency 1	R/W	0 ~ 59000	0.01Hz
AG102	12602	313Ah	First jump frequency range 1	R/W	0 ~ 1000	0.01Hz
AG103	12603	313Bh	First jump frequency 2	R/W	0 ~ 59000	0.01Hz
AG104	12604	313Ch	First jump frequency range 2	R/W	0 ~ 1000	0.01Hz
AG105	12605	313Dh	First jump frequency 3	R/W	0 ~ 59000	0.01Hz
AG106	12606	313Eh	First jump frequency range 3	R/W	0 ~ 1000	0.01Hz
AG110	12610	3142h	First acceleration-hold frequency	R/W	0 ~ 59000	0.01Hz
AG111	12611	3143h	First acceleration-hold time	R/W	0 ~ 600	0.1s
AG112	12612	3144h	First deceleration-hold frequency	R/W	0 ~ 59000	0.01Hz
AG113	12613	3145h	First deceleration-hold time	R/W	0 ~ 600	0.1s
AG-20	12620	314Ch	Jogging frequency	R/W	0 ~ 1000	0.01Hz
AG-21	12621	314Dh	Jogging stop selection	R/W	0 ~ 5	1
AG201	22601	5849h	Second jump frequency 1	R/W	0 ~ 59000	0.01Hz
AG202	22602	584Ah	Second jump frequency range 1	R/W	0 ~ 1000	0.01Hz
AG203	22603	584Bh	Second jump frequency 2	R/W	0 ~ 59000	0.01Hz
AG204	22604	584Ch	Second jump frequency range 2	R/W	0 ~ 1000	0.01Hz
AG205	22605	584Dh	Second jump frequency 3	R/W	0 ~ 59000	0.01Hz
AG206	22606	584Eh	Second jump frequency range 3	R/W	0 ~ 1000	0.01Hz
AG210	22610	5852h	Second acceleration-hold frequency	R/W	0 ~ 59000	0.01Hz
AG211	22611	5853h	Second acceleration-hold time	R/W	0 ~ 600	0.1s
AG212	22612	5854h	Second deceleration-hold frequency	R/W	0 ~ 59000	0.01Hz
AG213	22613	5855h	Second deceleration-hold time	R/W	0 ~ 600	0.1s

Function Code	Register No. (decimal)	Register No. (hexadecimal)	Function Name	R/W	Monitor Content and Setting Item	Data Resolution / Unit
AH-01	12701	319Dh	PID1 selection	R/W	0 ~ 2	1
AH-02	12702	319Eh	PID1 deviation minus	R/W	0 ~ 1	1
AH-03	12703	319Fh	PID1 unit selection (PID1)	R/W	0 ~ 58	1
AH-04	12704	31A0h	PID1 scale adjustment (0%)	R/W	-10000 ~ 10000	1
AH-05	12705	31A1h	PID1 scale adjustment (100%)	R/W	-10000 ~ 10000	1
AH-06	12706	31A2h	PID1 scale adjustment (decimal point)	R/W	0 ~ 4	1
AH-07	12707	31A3h	PID1 target value 1 input destination selection	R/W	0 ~ 13	1
AH-10	12710	31A6h	PID1 target value 1 set value (High)	R/W	-10000 ~ 10000	Per AH-06 setting
(AH-11)	12711	31A7h	(Low)			
AH-12	12712	31A8h	PID1 multistage target value 1 (High)	R/W	-10000 ~ 10000	Per AH-06 setting
(AH-13)	12713	31A9h	(Low)			
AH-14	12714	31Aah	PID1 multistage target value 2 (High)	R/W	-10000 ~ 10000	Per AH-06 setting
(AH-15)	12715	31Abh	(Low)			
AH-16	12716	31Ach	PID1 multistage target value 3 (High)	R/W	-10000 ~ 10000	Per AH-06 setting
(AH-17)	12717	31Adh	(Low)			
AH-18	12718	31Aeh	PID1 multistage target value 4 (High)	R/W	-10000 ~ 10000	Per AH-06 setting
(AH-19)	12719	31Afh	(Low)			
AH-20	12720	31B0h	PID1 multistage target value 5 (High)	R/W	-10000 ~ 10000	Per AH-06 setting
(AH-21)	12721	31B1h	(Low)			
AH-22	12722	31B2h	PID1 multistage target value 6 (High)	R/W	-10000 ~ 10000	Per AH-06 setting
(AH-23)	12723	31B3h	(Low)			
AH-24	12724	31B4h	PID1 multistage target value 7 (High)	R/W	-10000 ~ 10000	Per AH-06 setting
(AH-25)	12725	31B5h	(Low)			
AH-26	12726	31B6h	PID1 multistage target value 8 (High)	R/W	-10000 ~ 10000	Per AH-06 setting
(AH-27)	12727	31B7h	(Low)			
AH-28	12728	31B8h	PID1 multistage target value 9 (High)	R/W	-10000 ~ 10000	Per AH-06 setting
(AH-29)	12729	31B9h	(Low)			
AH-30	12730	31Bah	PID1 multistage target value 10 (High)	R/W	-10000 ~ 10000	Per AH-06 setting
(AH-31)	12731	31BBh	(Low)			
AH-32	12732	31BCh	PID1 multistage target value 11 (High)	R/W	-10000 ~ 10000	Per AH-06 setting
(AH-33)	12733	31BDh	(Low)			
AH-34	12734	31Beh	PID1 multistage target value 12 (High)	R/W	-10000 ~ 10000	Per AH-06 setting
(AH-35)	12735	31BFh	(Low)			
AH-36	12736	31C0h	PID1 multistage target value 13 (High)	R/W	-10000 ~ 10000	Per AH-06 setting
(AH-37)	12737	31C1h	(Low)			
AH-38	12738	31C2h	PID1 multistage target value 14 (High)	R/W	-10000 ~ 10000	Per AH-06 setting
(AH-39)	12739	31C3h	(Low)			
AH-40	12740	31C4h	PID1 multistage target value 15 (High)	R/W	-10000 ~ 10000	Per AH-06 setting
(AH-41)	12741	31C5h	(Low)			
AH-42	12742	31C6h	PID1 target value 2 input destination selection	R/W	0 ~ 13	1
AH-44	12744	31C8h	PID1 target value 2 set value (High)	R/W	-10000 ~ 10000	Per AH-06 setting
(AH-45)	12745	31C9h	(Low)			
<b>AH-46</b>	12746	31Cah	PID1 target value 3 input destination selection	R/W	0 ~ 13	1
<b>AH-48</b>	12748	31CCh	PID1 target value 3 set value (High)	R/W	-10000 ~ 10000	Per AH-06 setting
<b>(AH-49)</b>	12749	31CDh	(Low)			

Function Code	Register No. (decimal)	Register No. (hexadecimal)	Function Name	R/W	Monitor Content and Setting Item	Data Resolution / Unit
AH-50	12750	31Ceh	PID1 target value 1 operator selection	R/W	1 ~ 6	1
AH-51	12751	31CFh	PID1 feedback data 1 input destination selection	R/W	0 ~ 13	1
AH-52	12752	31D0h	PID1 feedback data 2 input destination selection	R/W	0 ~ 13	1
<b>AH-53</b>	12753	31D1h	PID1 feedback data 3 input destination selection	R/W	0 ~ 13	1
AH-54	12754	31D2h	PID1 feedback data operator selection	R/W	1 ~ 10	1
AH-60	12760	31D8h	PID1 gain switch method selection	R/W	0 ~ 1	1
AH-61	12761	31D9h	PID1 proportional gain 1	R/W	0 ~ 1000	0.1
AH-62	12762	31Dah	PID1 integral gain 1	R/W	0 ~ 36000	0.1s
AH-63	12763	31DBh	PID1 differential gain 1	R/W	0 ~ 10000	0.01s
AH-64	12764	31DCh	PID1 proportional gain 2	R/W	0 ~ 1000	0.1
AH-65	12765	31DDh	PID1 integral gain 2	R/W	0 ~ 36000	0.1s
AH-66	12766	31Deh	PID1 differential gain 2	R/W	0 ~ 10000	0.01s
AH-67	12767	31DFh	PID1 gain switch time	R/W	0 ~ 10000	1ms
AH-70	12770	31E2h	PID1 feed forward selection	R/W	0 ~ 6	1
AH-71	12771	31E3h	PID1 changeable range	R/W	0 ~ 10000	0.01%
AH-72	12772	31E4h	PID1 deviation excessive level	R/W	0 ~ 10000	0.01%
AH-73	12773	31E5h	PID1 feedback comparison signal OFF level	R/W	0 ~ 10000	0.01%
AH-74	12774	31E6h	PID1 feedback comparison signal ON level	R/W	0 ~ 10000	0.01%
AH-75	12775	31E7h	PID soft-start function selection	R/W	0 ~ 1	1
AH-76	12776	31E8h	PID soft-start target level	R/W	0 ~ 10000	0.01%
AH-78	12778	31Eah	Acceleration time for PID soft-start (High)	R/W	0 ~ 360000	0.01s
(AH-79)	12779	31Ebh	(Low)			
AH-80	12780	31Ech	PID soft-start time	R/W	0 ~ 10000	0.01s
<b>AH-81</b>	12781	31Edh	PID start abnormal judgment implement selection	R/W	0 ~ 2	1
<b>AH-82</b>	12782	31Eeh	PID start abnormal judgment level	R/W	0 ~ 10000	0.01%
AH-85	12785	31F1h	PID sleep condition selection	R/W	0 ~ 2	1
AH-86	12786	31F2h	PID sleep start level	R/W	0 ~ 59000	0.01Hz
AH-87	12787	31F3h	PID sleep operation time	R/W	0 ~ 10000	0.01s
<b>AH-88</b>	12788	31F4h	Boost selection prior to PID sleep	R/W	0 ~ 1	1
<b>AH-89</b>	12789	31F5h	Boost time prior to PID sleep	R/W	0 ~ 10000	0.01s
<b>AH-90</b>	12790	31F6h	Boost amount prior to PID sleep	R/W	0 ~ 10000	0.01%
<b>AH-91</b>	12791	31F7h	Minimum operation time prior to PID sleep	R/W	0 ~ 10000	0.01s
<b>AH-92</b>	12792	31F8h	PID sleep status minimum retaining time	R/W	0 ~ 10000	0.01s
AH-93	12793	31F9h	PID wake condition selection	R/W	1 ~ 3	1
AH-94	12794	31Fah	PID wake start level	R/W	0 ~ 10000	0.01%
AH-95	12795	31FBh	PID wake operation time	R/W	0 ~ 10000	0.01s
AH-96	12796	31FCh	PID wake start deviation amount	R/W	0 ~ 10000	0.01%
AJ-01	12801	3201h	PID2 selection	R/W	0 ~ 2	1
AJ-02	12802	3202h	PID2 deviation minus	R/W	0 ~ 1	1
AJ-03	12803	3203h	PID2 unit selection (PID2)	R/W	0 ~ 58	1
AJ-04	12804	3204h	PID2 scale adjustment (0%)	R/W	-10000 ~ 10000	1
AJ-05	12805	3205h	PID2 scale adjustment (100%)	R/W	-10000 ~ 10000	1
AJ-06	12806	3206h	PID2 scale adjustment (decimal point)	R/W	0 ~ 4	1
AJ-07	12807	3207h	PID2 target value input destination selection	R/W	0 ~ 15	1

Function Code	Register No. (decimal)	Register No. (hexadecimal)	Function Name	R/W	Monitor Content and Setting Item	Data Resolution / Unit
AJ-10	12810	320Ah	PID2 target value set value (High)	R/W	-10000 ~ 10000	Per AJ-06 setting
(AJ-11)	12811	320Bh	(Low)			
AJ-12	12812	320Ch	PID2 feedback data input destination selection	R/W	0 ~ 13	1
AJ-13	12813	320Dh	PID2 proportional gain	R/W	0 ~ 1000	0.1
AJ-14	12814	320Eh	PID2 integral gain	R/W	0 ~ 36000	0.1s
AJ-15	12815	320Fh	PID2 differential gain	R/W	0 ~ 10000	0.01s
AJ-16	12816	3210h	PID2 changeable range	R/W	0 ~ 10000	0.01%
AJ-17	12817	3211h	PID2 deviation excessive level	R/W	0 ~ 10000	0.01%
AJ-18	12818	3212h	PID2 feedback comparison signal OFF level	R/W	0 ~ 10000	0.01%
AJ-19	12819	3213h	PID2 feedback comparison signal ON level	R/W	0 ~ 10000	0.01%
AJ-21	12821	3215h	PID3 selection	R/W	0 ~ 2	1
AJ-22	12822	3216h	PID3 deviation minus	R/W	0 ~ 1	1
AJ-23	12823	3217h	PID3 unit selection (PID3)	R/W	0 ~ 58	1
AJ-24	12824	3218h	PID3 scale adjustment (0%)	R/W	-10000 ~ 10000	1
AJ-25	12825	3219h	PID3 scale adjustment (100%)	R/W	-10000 ~ 10000	1
AJ-26	12826	321Ah	PID3 scale adjustment (decimal point)	R/W	0 ~ 4	1
AJ-27	12827	321Bh	PID3 target value input destination selection	R/W	0 ~ 13	1
AJ-30	12830	321Eh	PID3 target value setting (High)	R/W	-10000 ~ 10000	Per AJ-26 setting
(AJ-31)	12831	321Fh	(Low)			
AJ-32	12832	3220h	PID3 feedback data input destination selection	R/W	0 ~ 13	1
AJ-33	12833	3221h	PID3 proportional gain	R/W	0 ~ 1000	0.1
AJ-34	12834	3222h	PID3 integral gain	R/W	0 ~ 36000	0.1s
AJ-35	12835	3223h	PID3 differential gain	R/W	0 ~ 10000	0.01s
AJ-36	12836	3224h	PID3 changeable range	R/W	0 ~ 10000	0.01%
AJ-37	12837	3225h	PID3 deviation excessive level	R/W	0 ~ 10000	0.01%
AJ-38	12838	3226h	PID3 feedback comparison signal OFF level	R/W	0 ~ 10000	0.01%
AJ-39	12839	3227h	PID3 feedback comparison signal ON level	R/W	0 ~ 10000	0.01%
AJ-41	12841	3229h	PID4 selection	R/W	0 ~ 2	1
AJ-42	12842	322Ah	PID4 deviation minus	R/W	0 ~ 1	1
AJ-43	12843	322Bh	PID4 unit selection (PID4)	R/W	0 ~ 58	1
AJ-44	12844	322Ch	PID4 scale adjustment (0%)	R/W	-10000 ~ 10000	1
AJ-45	12845	322Dh	PID4 scale adjustment (100%)	R/W	-10000 ~ 10000	1
AJ-46	12846	322Eh	PID4 scale adjustment (decimal point)	R/W	0 ~ 4	1
AJ-47	12847	322Fh	PID4 target value input destination selection	R/W	0 ~ 13	1
AJ-50	12850	3232h	PID4 target value setting (High)	R/W	-10000 ~ 10000	Per AJ-46 setting
(AJ-51)	12851	3233h	(Low)			
AJ-52	12852	3234h	PID4 feedback data input destination selection	R/W	0 ~ 13	1
AJ-53	12853	3235h	PID4 proportional gain	R/W	0 ~ 1000	0.1
AJ-54	12854	3236h	PID4 integral gain	R/W	0 ~ 36000	0.1s
AJ-55	12855	3237h	PID4 differential gain	R/W	0 ~ 10000	0.01s
AJ-56	12856	3238h	PID4 changeable range	R/W	0 ~ 10000	0.01%
AJ-57	12857	3239h	PID4 deviation excessive level	R/W	0 ~ 10000	0.01%
AJ-58	12858	323Ah	PID4 feedback comparison signal OFF level	R/W	0 ~ 10000	0.01%
AJ-59	12859	323Bh	PID4 feedback comparison signal ON level	R/W	0 ~ 10000	0.01%

Function Code	Register No. (decimal)	Register No. (hexadecimal)	Function Name	R/W	Monitor Content and Setting Item	Data Resolution / Unit
<b>bA101</b>	13001	32C9h	First frequency upper limit selection	R/W	0 ~ 13	1
bA102	13002	32Cah	First frequency upper limiter	R/W	0 ~ 59000	0.01Hz
bA103	13003	32CBh	First frequency lower limiter	R/W	0 ~ 59000	0.01Hz
bA110	13010	32D2h	First torque limit selection	R/W	0 ~ 11	1
bA111	13011	32D3h	First torque limit parameter mode selection	R/W	0 ~ 1	1
bA112	13012	32D4h	First torque limit 1 (Four quadrant normal powered)	R/W	0 ~ 5000	0.1%
bA113	13013	32D5h	First torque limit 2 (Four quadrant reverse regenerative)	R/W	0 ~ 5000	0.1%
bA114	13014	32D6h	First torque limit 3 (Four quadrant reverse powered)	R/W	0 ~ 5000	0.1%
bA115	13015	32D7h	First torque limit 4 (Four quadrant normal regenerative)	R/W	0 ~ 5000	0.1%
bA116	13016	32D8h	First torque LAD stop selection	R/W	0 ~ 1	1
bA120	13020	32DCh	First overcurrent suppression selection	R/W	0 ~ 1	1
bA121	13021	32DDh	First overcurrent suppression level	R/W	(0 to 2.00) * CTL rated current	0.1A
bA122	13022	32Deh	First overload limit 1 selection	R/W	0 ~ 3	1
bA123	13023	32DFh	First overload limit 1 level	R/W	(0.20 to 2.00) * CTL rated current	0.1A
bA124	13024	32E0h	First overload limit 1 operation time (High)	R/W	10 ~ 360000	0.01s
(bA125)	13025	32E1h	(Low)			
bA126	13026	32E2h	First overload limit 2 selection	R/W	0 ~ 3	1
bA127	13027	32E3h	First overload limit 2 level	R/W	(0.20 to 2.00) * CTL rated current	0.1A
bA128	13028	32E4h	First overload limit 2 operation time (High)	R/W	10 ~ 360000	0.01s
(bA129)	13029	32E5h	(Low)			
bA-30	13030	32E6h	Instantaneous power failure non-stop selection	R/W	0 ~ 3	1
bA-31	13031	32E7h	Instantaneous power failure non-stop function starting voltage	R/W	200V class: 0 ~ 4100 400V class: 0 ~ 8200	0.1Vdc
bA-32	13032	32E8h	Instantaneous power failure non-stop target level	R/W	200V class: 0 ~ 4100 400V class: 0 ~ 8200	0.1Vdc
bA-34	13034	32Eah	Instantaneous power failure non-stop deceleration time (High)	R/W	1 ~ 360000	0.01s
(bA-35)	13035	32Ebh	(Low)			
bA-36	13036	32Ech	Instantaneous power failure non-stop deceleration starting range	R/W	0 ~ 1000	0.01Hz
bA-37	13037	32Edh	Instantaneous power failure non-stop constant DC voltage control P gain	R/W	0 ~ 500	0.01
bA-38	13038	32Eeh	Instantaneous power failure non-stop constant DC voltage control I gain	R/W	0 ~ 15000	0.01s
bA140	13040	32F0h	First overvoltage suppression function selection	R/W	0 ~ 3	1
bA141	13041	32F1h	First overvoltage suppression level setting	R/W	200V class: 3300 ~ 4000 400V class: 6600 ~ 8000	0.1Vdc
bA142	13042	32F2h	First overvoltage suppression operating time (High)	R/W	0 ~ 360000	0.01s
(bA143)	13043	32F3h	(Low)			
bA144	13044	32F4h	First constant DC voltage control P gain	R/W	0 ~ 500	0.01
bA145	13045	32F5h	First constant DC voltage control I gain	R/W	0 ~ 15000	0.01s
bA146	13046	32F6h	First overexcitation function selection (V/f)	R/W	0 ~ 4	1
bA147	13047	32F7h	First overexcitation output filter time constant (V/f)	R/W	0 ~ 100	0.01s
bA148	13048	32F8h	First overexcitation voltage gain (V/f)	R/W	50 ~ 400	1%
bA149	13049	32F9h	First overexcitation suppression level setting (V/f)	R/W	200V class: 3300 ~ 4000 400V class: 6600 ~ 8000	0.1Vdc



Function Code	Register No. (decimal)	Register No. (hexadecimal)	Function Name	R/W	Monitor Content and Setting Item	Data Resolution / Unit
bA-60	13060	3304h	BRD use rate	R/W	0 - 1000 (linked with bA-63)	0.1%
bA-61	13061	3305h	BRD selection	R/W	0 ~ 2	1
bA-62	13062	3306h	BRD ON level	R/W	200V class: 3300 ~ 4000 400V class: 6600 ~ 8000	0.1Vdc
bA-63	13063	3307h	BRD resistance	R/W	From the minimum resistance to 600.0	0.1Ω
bA-70	13070	330Eh	Cooling fan operation selection	R/W	0 ~ 2	1
bA-71	13071	330Fh	Selection of cumulative cooling fan operating time clearance	R/W	0 ~ 1	1
<b>bA201</b>	23001	59D9h	Second frequency upper limit selection	R/W	0 ~ 13	1
bA202	23002	59Dah	Second frequency upper limiter	R/W	0 ~ 59000	0.01Hz
bA203	23003	59DBh	Second frequency lower limiter	R/W	0 ~ 59000	0.01Hz
bA210	23010	59E2h	Second torque limit selection	R/W	0 ~ 11	1
bA211	23011	59E3h	Second torque limit parameter mode selection	R/W	0 ~ 1	1
bA212	23012	59E4h	Second torque limit 1 (Four quadrant normal powered)	R/W	0 ~ 5000	0.1%
bA213	23013	59E5h	Second torque limit 2 (Four quadrant reverse regenerative)	R/W	0 ~ 5000	0.1%
bA214	23014	59E6h	Second torque limit 3 (Four quadrant reverse powered)	R/W	0 ~ 5000	0.1%
bA215	23015	59E7h	Second torque limit 4 (Four quadrant normal regenerative)	R/W	0 ~ 5000	0.1%
bA216	23016	59E8h	Second torque LAD stop selection	R/W	0 ~ 1	1
bA220	23020	59Ech	Second overcurrent suppression selection	R/W	0 ~ 1	1
bA221	23021	59Edh	Second overcurrent suppression level	R/W	(0 to 2.00) * CTL rated current	0.1A
bA222	23022	59Eeh	Second overload limit 1 selection	R/W	0 ~ 3	1
bA223	23023	59Efh	Second overload limit 1 level	R/W	(0.20 to 2.00) * CTL rated current	0.1A
bA224	23024	59F0h	Second overload limit 1 operation time (High)	R/W	10 ~ 360000	0.01s
(bA225)	23025	59F1h	(Low)			
bA226	23026	59F2h	Second overload limit 2 selection	R/W	0 ~ 3	1
bA227	23027	59F3h	Second overload limit 2 level	R/W	(0.20 to 2.00) * CTL rated current	0.1A
bA228	23028	59F4h	Second overload limit 2 operation time (High)	R/W	10 ~ 360000	0.01s
(bA229)	23029	59F5h	(Low)			
bA240	23040	5A00h	Second overvoltage suppression function selection	R/W	0 ~ 3	1
bA241	23041	5A01h	Second overvoltage suppression level setting	R/W	200V class: 3300 ~ 4000 400V class: 6600 ~ 8000	0.1Vdc
bA242	23042	5A02h	Second overvoltage suppression operating time (High)	R/W	0 ~ 360000	0.01s
(bA243)	23043	5A03h	(Low)			
bA244	23044	5A04h	Second constant DC voltage control P gain	R/W	0 ~ 500	0.01
bA245	23045	5A05h	Second constant DC voltage control I gain	R/W	0 ~ 15000	0.01s
bA246	23046	5A06h	Second overexcitation function selection (V/f)	R/W	0 ~ 4	1
bA247	23047	5A07h	Second overexcitation output filter time constant (V/f)	R/W	0 ~ 100	0.01s
bA248	23048	5A08h	Second overexcitation voltage gain (V/f)	R/W	50 ~ 400	1%
bA249	23049	5A09h	Second overexcitation suppression level setting (V/f)	R/W	200V class: 3300 ~ 4000 400V class: 6600 ~ 8000	0.1Vdc

Function Code	Register No. (decimal)	Register No. (hexadecimal)	Function Name	R/W	Monitor Content and Setting Item	Data Resolution / Unit
bb101	13101	332Dh	First carrier frequency	R/W	5 to 160 (varies depending on selection of capacity and load rating)	0.1kHz
<b>bb102</b>	13102	332Eh	First sprinkle carrier pattern selection	R/W	0 ~ 3	1
bb103	13103	332Fh	First automatic carrier frequency reduction selection	R/W	0 ~ 2	1
<b>bb-10</b>	13110	3336h	Auto-reset selection	R/W	0 ~ 2	1
<b>bb-11</b>	13111	3337h	Alarm output selection when the auto-reset is enabled	R/W	0 ~ 1	1
<b>bb-12</b>	13112	3338h	Automatic resetting stand-by time	R/W	0 ~ 600	1s
<b>bb-13</b>	13113	3339h	Automatic resetting count setting	R/W	0 ~ 10	1
bb-20	13120	3340h	Instantaneous power failure retry count selection	R/W	0 ~ 16 / 255	1
bb-21	13121	3341h	Undervoltage retry count selection	R/W	0 ~ 16 / 255	1
bb-22	13122	3342h	Overcurrent retry count selection	R/W	0 ~ 5	1
bb-23	13123	3343h	Overvoltage retry count selection	R/W	0 ~ 5	1
bb-24	13124	3344h	Selection of instantaneous power failure/undervoltage retry	R/W	0 ~ 4	1
bb-25	13125	3345h	Allowable instantaneous power failure time	R/W	3 ~ 250	0.1s
bb-26	13126	3346h	Retry wait time after instantaneous power failure/undervoltage	R/W	3 ~ 1000	0.1s
bb-27	13127	3347h	Instantaneous power failure/undervoltage tripping selection during stop	R/W	0 ~ 2	1
bb-28	13128	3348h	Overcurrent trip/retry selection	R/W	0 ~ 4	1
bb-29	13129	3349h	Retry wait time after overcurrent	R/W	3 ~ 1000	0.1s
bb-30	13130	334Ah	Overvoltage trip/retry selection	R/W	0 ~ 4	1
bb-31	13131	334Bh	Retry wait time after overvoltage	R/W	3 ~ 1000	0.1s
bb-40	13140	3354h	Restart after free-run release	R/W	0 ~ 3	1
bb-41	13141	3355h	Restart after reset release	R/W	0 ~ 3	1
bb-42	13142	3356h	Speed frequency matching lower limit frequency setting	R/W	0 ~ 59000	0.01Hz
bb-43	13143	3357h	Restarting level of frequency acquisition	R/W	(0.20 to 2.00) * CTL rated current	0.1A
bb-44	13144	3358h	Constant (speed) for frequency acquisition restarting	R/W	10 ~ 3000	0.01s
bb-45	13145	3359h	Constant (voltage) for frequency acquisition restarting	R/W	10 ~ 3000	0.01s
bb-46	13146	335Ah	Overcurrent suppression level for frequency acquisition restart	R/W	(0 to 2.00) * CTL rated current	0.1A
bb-47	13147	335Bh	Start speed selection for frequency acquisition restart	R/W	0 ~ 2	1
bb160	13160	3368h	First overcurrent detection level	R/W	(0.20 to 2.20) * ND rated current	0.1A
bb-61	13161	3369h	Incoming overvoltage selection	R/W	0 ~ 1	1
bb-62	13162	336Ah	Incoming overvoltage level selection	R/W	200V class: 3000 ~ 4100 400V class: 6000 ~ 8200	0.1Vdc
<b>bb-64</b>	13164	336Ch	Ground fault detection selection	R/W	0 ~ 1	1
bb-65	13165	336Dh	Input phase loss selection	R/W	0 ~ 1	1
bb-66	13166	336Eh	Output phase loss selection	R/W	0 ~ 1	1
bb-67	13167	336Fh	Output phase loss detection sensitivity	R/W	1 ~ 100	1%
bb-70	13170	3372h	Thermistor error level	R/W	0 ~ 10000	1Ω
<b>bb-80</b>	13180	337Ch	Over-speed error detection level	R/W	0 ~ 1500	0.1%
<b>bb-81</b>	13181	337Dh	Over-speed error detection time	R/W	0 ~ 50	0.1s
<b>bb-82</b>	13182	337Eh	Operation for speed deviation error	R/W	0 ~ 1	1
<b>bb-83</b>	13183	337Fh	Speed deviation error detection level	R/W	0 ~ 1000	0.1%
<b>bb-84</b>	13184	3380h	Speed deviation error detection time	R/W	0 ~ 50	0.1s
<b>bb-85</b>	13185	3381h	Behavior when the position deviation is abnormal	R/W	0 ~ 1	1
<b>bb-86</b>	13186	3382h	Abnormal position deviation detection level	R/W	0 ~ 65535 (*100pls)	1 (*100pls)
<b>bb-87</b>	13187	3383h	Abnormal position deviation time	R/W	0 ~ 50	0.1s

Function Code	Register No. (decimal)	Register No. (hexadecimal)	Function Name	R/W	Monitor Content and Setting Item	Data Resolution / Unit
bb201	23101	5A3Dh	Second carrier frequency	R/W	5 to 160 (varies depending on selection of capacity and load rating)	0.1kHz
<b>bb202</b>	23102	5A3Eh	Second sprinkle carrier pattern selection	R/W	0 ~ 3	1
bb203	23103	5A3Fh	Second automatic carrier frequency reduction selection	R/W	0 ~ 2	1
bb260	23160	5A78h	Second overcurrent detection level	R/W	(0.20 to 2.20) * ND rated current	0.1A
bC110	13210	339Ah	First electronic thermal level	R/W	(0 to 3.00) * CTL rated current	0.1A
bC111	13211	339Bh	First electronic thermal characteristics selection	R/W	0 ~ 2	1
bC112	13212	339Ch	First electronic thermal subtraction function selection	R/W	0 ~ 1	1
bC113	13213	339Dh	First electronic thermal subtraction time	R/W	1 ~ 1000	1s
bC-14	13214	339Eh	Electronic thermal counter memory at power-off	R/W	0 ~ 1	1
bC120	13220	33A4h	First free electronic thermal frequency 1	R/W	0 ~ 59000 (bC122)	0.01Hz
bC121	13221	33A5h	First free electronic thermal current 1	R/W	(0 to 3.00) * CTL rated current	0.1A
bC122	13222	33A6h	First free electronic thermal frequency 2	R/W	0 ~ 59000 (bC120 ~ bC124)	0.01Hz
bC123	13223	33A7h	First free electronic thermal current 2	R/W	(0 to 3.00) * CTL rated current	0.1A
bC124	13224	33A8h	First free electronic thermal frequency 3	R/W	0 (bC122) ~ 59000	0.01Hz
bC125	13225	33A9h	First free electronic thermal current 3	R/W	(0 to 3.00) * CTL rated current	0.1A
bC210	23210	5AAAh	Second electronic thermal level	R/W	(0 to 3.00) * CTL rated current	0.1A
bC211	23211	5AABh	Second electronic thermal characteristics selection	R/W	0 ~ 2	1
bC212	23212	5AACH	Second electronic thermal subtraction function selection	R/W	0 ~ 1	1
bC213	23213	5AADh	Second electronic thermal subtraction time	R/W	1 ~ 1000	1s
bC220	23220	5AB4h	Second free electronic thermal frequency 1	R/W	0 ~ 59000 (bC222)	0.01Hz
bC221	23221	5AB5h	Second free electronic thermal current 1	R/W	(0 to 3.00) * CTL rated current	0.1A
bC222	23222	5AB6h	Second free electronic thermal frequency 2	R/W	0 ~ 59000 (bC220 ~ bC224)	0.01Hz
bC223	23223	5AB7h	Second free electronic thermal current 2	R/W	(0 to 3.00) * CTL rated current	0.1A
bC224	23224	5AB8h	Second free electronic thermal frequency 3	R/W	0 (bC222) ~ 59000	0.01Hz
bC225	23225	5AB9h	Second free electronic thermal current 3	R/W	(0 to 3.00) * CTL rated current	0.1A
bd-01	13301	33F5h	STO input indication selection	R/W	0 ~ 2	1
bd-02	13302	33F6h	STO allowable input switch time	R/W	0 ~ 6000	0.01s
bd-03	13303	33F7h	STO indication selection within allowable input time	R/W	0 ~ 1	1
bd-04	13304	33F8h	STO operation selection after allowable input time	R/W	0 ~ 2	1

Function Code	Register No. (decimal)	Register No. (hexadecimal)	Function Name	R/W	Monitor Content and Setting Item	Data Resolution / Unit
CA-01	14001	36B1h	Selection of input terminal [1]	R/W	0 ~ 110	1
CA-02	14002	36B2h	Selection of input terminal [2]	R/W	0 ~ 110	1
CA-03	14003	36B3h	Selection of input terminal [3]	R/W	0 ~ 110	1
CA-04	14004	36B4h	Selection of input terminal [4]	R/W	0 ~ 110	1
CA-05	14005	36B5h	Selection of input terminal [5]	R/W	0 ~ 110	1
CA-06	14006	36B6h	Selection of input terminal [6]	R/W	0 ~ 110	1
CA-07	14007	36B7h	Selection of input terminal [7]	R/W	0 ~ 110	1
CA-08	14008	36B8h	Selection of input terminal [8]	R/W	0 ~ 110	1
CA-09	14009	36B9h	Selection of input terminal [9]	R/W	0 ~ 110	1
CA-10	14010	36Bah	Selection of input terminal [A]	R/W	0 ~ 110	1
CA-11	14011	36BBh	Selection of input terminal [B]	R/W	0 ~ 110	1
CA-21	14021	36C5h	Selection of Input terminal [1] a/b (NO/NC)	R/W	0 ~ 1	1
CA-22	14022	36C6h	Selection of Input terminal [2] a/b (NO/NC)	R/W	0 ~ 1	1
CA-23	14023	36C7h	Selection of Input terminal [3] a/b (NO/NC)	R/W	0 ~ 1	1
CA-24	14024	36C8h	Selection of Input terminal [4] a/b (NO/NC)	R/W	0 ~ 1	1
CA-25	14025	36C9h	Selection of Input terminal [5] a/b (NO/NC)	R/W	0 ~ 1	1
CA-26	14026	36Cah	Selection of Input terminal [6] a/b (NO/NC)	R/W	0 ~ 1	1
CA-27	14027	36CBh	Selection of Input terminal [7] a/b (NO/NC)	R/W	0 ~ 1	1
CA-28	14028	36CCh	Selection of Input terminal [8] a/b (NO/NC)	R/W	0 ~ 1	1
CA-29	14029	36CDh	Selection of Input terminal [9] a/b (NO/NC)	R/W	0 ~ 1	1
CA-30	14030	36Ceh	Selection of Input terminal [A] a/b (NO/NC)	R/W	0 ~ 1	1
CA-31	14031	36CFh	Selection of Input terminal [B] a/b (NO/NC)	R/W	0 ~ 1	1
CA-41	14041	36D9h	Input terminal [1] response time	R/W	0 ~ 400	1ms
CA-42	14042	36Dah	Input terminal [2] response time	R/W	0 ~ 400	1ms
CA-43	14043	36DBh	Input terminal [3] response time	R/W	0 ~ 400	1ms
CA-44	14044	36DCh	Input terminal [4] response time	R/W	0 ~ 400	1ms
CA-45	14045	36DDh	Input terminal [5] response time	R/W	0 ~ 400	1ms
CA-46	14046	36Deh	Input terminal [6] response time	R/W	0 ~ 400	1ms
CA-47	14047	36DFh	Input terminal [7] response time	R/W	0 ~ 400	1ms
CA-48	14048	36E0h	Input terminal [8] response time	R/W	0 ~ 400	1ms
CA-49	14049	36E1h	Input terminal [9] response time	R/W	0 ~ 400	1ms
CA-50	14050	36E2h	Input terminal [A] response time	R/W	0 ~ 400	1ms
CA-51	14051	36E3h	Input terminal [B] response time	R/W	0 ~ 400	1ms
CA-55	14055	36E7h	Multi-step input determination time	R/W	0 ~ 2000	1ms
CA-60	14060	36Ech	FUP/FDN overwriting target selection	R/W	0 ~ 1	1
CA-61	14061	36Edh	FUP/FDN memory selection	R/W	0 ~ 1	1
CA-62	14062	36Eeh	FUP/FDN UDC terminal mode selection	R/W	0 ~ 1	1
CA-64	14064	36F0h	Acceleration time for FUP/FDN functions (High)	R/W	0 ~ 360000	0.01s
(CA-65)	14065	36F1h	(Low)			
CA-66	14066	36F2h	Deceleration time for FUP/FDN functions (High)	R/W	0 ~ 360000	0.01s
(CA-67)	14067	36F3h	(Low)			
CA-70	14070	36F6h	Speed command selection with [F-OP] enabled.	R/W	1 ~ 16	1
CA-71	14071	36F7h	Operation command selection with [F-OP] enabled.	R/W	0 ~ 6	1
CA-72	14072	36F8h	Reset selection	R/W	0 ~ 3	1

Function Code	Register No. (decimal)	Register No. (hexadecimal)	Function Name	R/W	Monitor Content and Setting Item	Data Resolution / Unit
<b>CA-81</b>	14081	3701h	Encoder constant set-up	R/W	32 ~ 65535	1pls
<b>CA-82</b>	14082	3702h	Encoder phase sequence selection	R/W	0 ~ 1	1
<b>CA-83</b>	14083	3703h	Motor gear ratio's numerator	R/W	1 ~ 10000	1
<b>CA-84</b>	14084	3704h	Motor gear ratio's denominator	R/W	1 ~ 10000	1
CA-90	14090	370Ah	Pulse train input (internal) detection target selection	R/W	0 ~ 3	1
CA-91	14091	370Bh	Pulse train input (internal) mode selection	R/W	0 ~ 2	1
CA-92	14092	370Ch	Pulse train frequency scale	R/W	5 ~ 3200	0.01kHz
CA-93	14093	370Dh	Pulse train frequency filter time constant	R/W	1 ~ 200	0.01s
CA-94	14094	370Eh	Pulse train frequency bias amount	R/W	-1000 ~ 1000	0.1%
CA-95	14095	370Fh	Pulse train frequency detection upper limit	R/W	0 ~ 1000	0.1%
CA-96	14096	3710h	Pulse train frequency detection lower level	R/W	0 ~ 1000	0.1%
<b>CA-97</b>	14097	3711h	Pulse count compare-match output ON level	R/W	0 ~ 65535	1
<b>CA-98</b>	14098	3712h	Pulse count compare-match output OFF level	R/W	0 ~ 65535	1
<b>CA-99</b>	14099	3713h	Maximum value for pulse count compare-match output	R/W	0 ~ 65535	1
Cb-01	14101	3715h	[Ai1] terminal input filter time constant	R/W	1 ~ 500	1ms
Cb-03	14103	3717h	[Ai1] terminal start amount	R/W	0 ~ 10000	0.01%
Cb-04	14104	3718h	[Ai1] terminal end amount	R/W	0 ~ 10000	0.01%
Cb-05	14105	3719h	[Ai1] terminal start ratio	R/W	0 ~ 1000 (Cb-06)	0.1%
Cb-06	14106	371Ah	[Ai1] terminal end ratio	R/W	(Cb-05) 0 ~ 1000	0.1%
Cb-07	14107	371Bh	[Ai1] terminal start selection	R/W	0 ~ 1	1
Cb-11	14111	371Fh	[Ai2] terminal input filter time constant	R/W	1 ~ 500	1ms
Cb-13	14113	3721h	[Ai2] terminal start amount	R/W	0 ~ 10000	0.01%
Cb-14	14114	3722h	[Ai2] terminal end amount	R/W	0 ~ 10000	0.01%
Cb-15	14115	3723h	[Ai2] terminal start ratio	R/W	0 ~ 1000 (Cb-16)	0.1%
Cb-16	14116	3724h	[Ai2] terminal end ratio	R/W	(Cb-15) 0 ~ 1000	0.1%
Cb-17	14117	3725h	[Ai2] terminal start selection	R/W	0 ~ 1	1
Cb-21	14121	3729h	[Ai3] terminal input filter time constant	R/W	1 ~ 500	1ms
Cb-22	14122	372Ah	[Ai3] terminal selection	R/W	0 ~ 2	1
Cb-23	14123	372Bh	[Ai3] terminal start amount	R/W	-10000 ~ 10000	0.01%
Cb-24	14124	372Ch	[Ai3] terminal end amount	R/W	-10000 ~ 10000	0.01%
Cb-25	14125	372Dh	[Ai3] terminal start ratio	R/W	-1000 ~ 1000 (Cb-26)	0.1%
Cb-26	14126	372Eh	[Ai3] terminal end ratio	R/W	(Cb-25)-1000 ~ 1000	0.1%
Cb-30	14130	3732h	[Ai1] voltage/current bias adjustment	R/W	-10000 ~ 10000	0.01%
Cb-31	14131	3733h	[Ai1] voltage/current adjustment gain	R/W	0 ~ 20000	0.01%
Cb-32	14132	3734h	[Ai2] voltage/current bias adjustment	R/W	-10000 ~ 10000	0.01%
Cb-33	14133	3735h	[Ai2] voltage/current adjustment gain	R/W	0 ~ 20000	0.01%
Cb-34	14134	3736h	[Ai3] voltage bias adjustment	R/W	-10000 ~ 10000	0.01%
Cb-35	14135	3737h	[Ai3] voltage adjustment gain	R/W	0 ~ 20000	0.01%
Cb-40	14140	373Ch	Thermistor selection	R/W	0 ~ 2	1
Cb-41	14141	373Dh	Thermistor [TH+/TH-] adjustment	R/W	0 ~ 10000	0.1
<b>Cb-51</b>	14151	3747h	QOP-VR input filter time constant	R/W	1 ~ 500	1ms
<b>Cb-53</b>	14153	3749h	QOP -VR start amount	R/W	0 ~ 10000	0.01%
<b>Cb-54</b>	14154	374Ah	QOP -VR end amount	R/W	0 ~ 10000	0.01%
<b>Cb-55</b>	14155	374Bh	QOP -VR start ratio	R/W	0 ~ 1000 (Cb-56)	0.1%
<b>Cb-56</b>	14156	374Ch	QOP -VR end ratio	R/W	(Cb-55) 0 ~ 1000	0.1%
<b>Cb-57</b>	14157	374Dh	QOP -VR start selection	R/W	0 ~ 1	1

Function Code	Register No. (decimal)	Register No. (hexadecimal)	Function Name	R/W	Monitor Content and Setting Item	Data Resolution / Unit
CC-01	14201	3779h	Selection of output terminal [11]	R/W	0 ~ 93	1
CC-02	14202	377Ah	Selection of output terminal [12]	R/W	0 ~ 93	1
CC-03	14203	377Bh	Selection of output terminal [13]	R/W	0 ~ 93	1
CC-04	14204	377Ch	Selection of output terminal [14]	R/W	0 ~ 93	1
CC-05	14205	377Dh	Selection of output terminal [15]	R/W	0 ~ 93	1
CC-06	14206	377Eh	Selection of relay output terminal [16]	R/W	0 ~ 93	1
CC-07	14207	377Fh	Selection of relay output terminal [AL]	R/W	0 ~ 93	1
CC-11	14211	3783h	Selection of output terminal [11] a/b (NO/NC)	R/W	0 ~ 1	1
CC-12	14212	3784h	Selection of output terminal [12] a/b (NO/NC)	R/W	0 ~ 1	1
CC-13	14213	3785h	Selection of output terminal [13] a/b (NO/NC)	R/W	0 ~ 1	1
CC-14	14214	3786h	Selection of output terminal [14] a/b (NO/NC)	R/W	0 ~ 1	1
CC-15	14215	3787h	Selection of output terminal [15] a/b (NO/NC)	R/W	0 ~ 1	1
CC-16	14216	3788h	Selection of output terminal [16] a/b (NO/NC)	R/W	0 ~ 1	1
CC-17	14217	3789h	Selection of output terminal [AL] a/b (NO/NC)	R/W	0 ~ 1	1
CC-20	14220	378Ch	Output terminal [11] on-delay time	R/W	0 ~ 10000	0.01s
CC-21	14221	378Dh	Output terminal [11] off-delay time	R/W	0 ~ 10000	0.01s
CC-22	14222	378Eh	Output terminal [12] on-delay time	R/W	0 ~ 10000	0.01s
CC-23	14223	378Fh	Output terminal [12] off-delay time	R/W	0 ~ 10000	0.01s
CC-24	14224	3790h	Output terminal [13] on-delay time	R/W	0 ~ 10000	0.01s
CC-25	14225	3791h	Output terminal [13] off-delay time	R/W	0 ~ 10000	0.01s
CC-26	14226	3792h	Output terminal [14] on-delay time	R/W	0 ~ 10000	0.01s
CC-27	14227	3793h	Output terminal [14] off-delay time	R/W	0 ~ 10000	0.01s
CC-28	14228	3794h	Output terminal [15] on-delay time	R/W	0 ~ 10000	0.01s
CC-29	14229	3795h	Output terminal [15] off-delay time	R/W	0 ~ 10000	0.01s
CC-30	14230	3796h	Output terminal [16] on-delay time	R/W	0 ~ 10000	0.01s
CC-31	14231	3797h	Output terminal [16] off-delay time	R/W	0 ~ 10000	0.01s
CC-32	14232	3798h	Output terminal [AL] on-delay time	R/W	0 ~ 10000	0.01s
CC-33	14233	3799h	Output terminal [AL] off-delay time	R/W	0 ~ 10000	0.01s
CC-40	14240	37A0h	Logical calculation output signal LOG1 selection 1	R/W	0 ~ 93	1
CC-41	14241	37A1h	Logical calculation output signal LOG1 selection 2	R/W	0 ~ 93	1
CC-42	14242	37A2h	Logical calculation output signal LOG1 operator selection	R/W	0 ~ 2	1
CC-43	14243	37A3h	Logical calculation output signal LOG2 selection 1	R/W	0 ~ 93	1
CC-44	14244	37A4h	Logical calculation output signal LOG2 selection 2	R/W	0 ~ 93	1
CC-45	14245	37A5h	Logical calculation output signal LOG2 operator selection	R/W	0 ~ 2	1
CC-46	14246	37A6h	Logical calculation output signal LOG3 selection 1	R/W	0 ~ 93	1
CC-47	14247	37A7h	Logical calculation output signal LOG3 selection 2	R/W	0 ~ 93	1
CC-48	14248	37A8h	Logical calculation output signal LOG3 operator selection	R/W	0 ~ 2	1
CC-49	14249	37A9h	Logical calculation output signal LOG4 selection 1	R/W	0 ~ 93	1
CC-50	14250	37Aah	Logical calculation output signal LOG4 selection 2	R/W	0 ~ 93	1
CC-51	14251	37Abh	Logical calculation output signal LOG4 operator selection	R/W	0 ~ 2	1
CC-52	14252	37Ach	Logical calculation output signal LOG5 selection 1	R/W	0 ~ 93	1
CC-53	14253	37Adh	Logical calculation output signal LOG5 selection 2	R/W	0 ~ 93	1
CC-54	14254	37Aeh	Logical calculation output signal LOG5 operator selection	R/W	0 ~ 2	1
CC-55	14255	37Afh	Logical calculation output signal LOG6 selection 1	R/W	0 ~ 93	1
CC-56	14256	37B0h	Logical calculation output signal LOG6 selection 2	R/W	0 ~ 93	1
CC-57	14257	37B1h	Logical calculation output signal LOG6 operator selection	R/W	0 ~ 2	1

Function Code	Register No. (decimal)	Register No. (hexadecimal)	Function Name	R/W	Monitor Content and Setting Item	Data Resolution / Unit
CC-58	14258	37B2h	Logical calculation output signal LOG7 selection 1	R/W	0 ~ 93	1
CC-59	14259	37B3h	Logical calculation output signal LOG7 selection 2	R/W	0 ~ 93	1
CC-60	14260	37B4h	Logical calculation output signal LOG7 operator selection	R/W	0 ~ 2	1
Cd-01	14301	37DDh	[FM] terminal output form selection	R/W	0 ~ 1	1
Cd-02	14302	37Deh	[FM] terminal standard frequency (for PWM output)	R/W	0 ~ 3600	1Hz
Cd-03	14303	37DFh	[FM] terminal output selection	R/W	0 to 65535 (register No. of d, F codes)	1
Cd-04	14304	37E0h	[Ao1] terminal output selection	R/W	0 to 65535 (register No. of d, F codes)	1
Cd-05	14305	37E1h	[Ao2] terminal output selection	R/W	0 to 65535 (register No. of d, F codes)	1
Cd-10	14310	37E6h	Analog monitor adjustment mode selection	R/W	0 ~ 1	1
Cd-11	14311	37E7h	[FM] output filter time constant	R/W	1 ~ 500	1ms
Cd-12	14312	37E8h	[FM] output data type selection	R/W	0 ~ 1	1
Cd-13	14313	37E9h	[FM] bias adjustment	R/W	-1000 ~ 1000	0.1%
Cd-14	14314	37Eah	[FM] gain adjustment	R/W	-10000 ~ 10000	0.1%
Cd-15	14315	37Ebh	[FM] output level in the adjustment mode	R/W	-1000 ~ 1000	0.1%
Cd-21	14321	37F1h	[Ao1] output filter time constant	R/W	1 ~ 500	1ms
Cd-22	14322	37F2h	[Ao1] output data type selection	R/W	0 ~ 1	1
Cd-23	14323	37F3h	[Ao1] bias adjustment (common to voltage/current)	R/W	-1000 ~ 1000	0.1%
Cd-24	14324	37F4h	[Ao1] gain adjustment (common to voltage/current)	R/W	-10000 ~ 10000	0.1%
Cd-25	14325	37F5h	[Ao1] output level in the adjustment mode	R/W	-1000 ~ 1000	0.1%
Cd-31	14331	37FBh	[Ao2] output filter time constant	R/W	1 ~ 500	1ms
Cd-32	14332	37FCh	[Ao2] output data type selection	R/W	0 ~ 1	1
Cd-33	14333	37FDh	[Ao2] bias adjustment (common to voltage/current)	R/W	-1000 ~ 1000	0.1%
Cd-34	14334	37Feh	[Ao2] gain adjustment (common to voltage/current)	R/W	-10000 ~ 10000	0.1%
Cd-35	14335	37FFh	[Ao2] output level in the adjustment mode	R/W	-1000 ~ 1000	0.1%
CE101	14401	3841h	First low current signal output mode selection	R/W	0 ~ 1	1
CE102	14402	3842h	First low current detection level 1	R/W	(0 to 2.00) * CTL rated current	0.1A
CE103	14403	3843h	First low current detection level 2	R/W	(0 to 2.00) * CTL rated current	0.1A
CE105	14405	3845h	First overload prewarning signal output mode selection	R/W	0 ~ 1	1
CE106	14406	3846h	First overload prewarning level 1	R/W	(0 to 2.00) * CTL rated current	0.1A
CE107	14407	3847h	First overload prewarning level 2	R/W	(0 to 2.00) * CTL rated current	0.1A
CE-10	14410	384Ah	Acceleration reaching frequency 1	R/W	0 ~ 59000	0.01Hz
CE-11	14411	384Bh	Deceleration reaching frequency 1	R/W	0 ~ 59000	0.01Hz
CE-12	14412	384Ch	Acceleration reaching frequency 2	R/W	0 ~ 59000	0.01Hz
CE-13	14413	384Dh	Deceleration reaching frequency 2	R/W	0 ~ 59000	0.01Hz
CE120	14420	3854h	First over torque level (normal powered)	R/W	0 ~ 5000	0.1%
CE121	14421	3855h	First over torque level (reverse regenerative)	R/W	0 ~ 5000	0.1%
CE122	14422	3856h	First over torque level (reverse powered)	R/W	0 ~ 5000	0.1%
CE123	14423	3857h	First over torque level (normal regenerative)	R/W	0 ~ 5000	0.1%
CE-30	14430	385Eh	Electronic thermal warning level (MTR)	R/W	0 ~ 10000	0.01%
CE-31	14431	385Fh	Electronic thermal warning level (CTL)	R/W	0 ~ 10000	0.01%
CE-33	14433	3861h	Zero-speed detection value level	R/W	0 ~ 10000	0.01Hz
CE-34	14434	3862h	Cooling fin heating prewarning level	R/W	0 ~ 200	1°C
CE-36	14436	3864h	RUN time/power supply ON time level (High)	R/W	0 ~ 100000	1hr
(CE-37)	14437	3865h	(Low)			

Function Code	Register No. (decimal)	Register No. (hexadecimal)	Function Name	R/W	Monitor Content and Setting Item	Data Resolution / Unit
CE-40	14440	3868h	Window comparator [Ai1] upper limit level	R/W	0 ~ 100	1%
CE-41	14441	3869h	Window comparator [Ai1] lower limit level	R/W	0 ~ 100	1%
CE-42	14442	386Ah	Window comparator [Ai1] hysteresis range	R/W	0 ~ 10	1%
CE-43	14443	386Bh	Window comparator [Ai2] upper limit level	R/W	0 ~ 100	1%
CE-44	14444	386Ch	Window comparator [Ai2] lower limit level	R/W	0 ~ 100	1%
CE-45	14445	386Dh	Window comparator [Ai2] hysteresis range	R/W	0 ~ 10	1%
CE-46	14446	386Eh	Window comparator [Ai3] upper limit level	R/W	-100 ~ 100	1%
CE-47	14447	386Fh	Window comparator [Ai3] lower limit level	R/W	-100 ~ 100	1%
CE-48	14448	3870h	Window comparator [Ai3] hysteresis range	R/W	0 ~ 10	1%
CE-50	14450	3872h	[Ai1] operation level at disconnection	R/W	0 ~ 100	1%
CE-51	14451	3873h	[Ai1] operation level selection at disconnection	R/W	0 ~ 2	1
CE-52	14452	3874h	[Ai2] operation level at disconnection	R/W	0 ~ 100	1%
CE-53	14453	3875h	[Ai2] operation level selection at disconnection	R/W	0 ~ 2	1
CE-54	14454	3876h	[Ai3] operation level at disconnection	R/W	-100 ~ 100	1%
CE-55	14455	3877h	[Ai3] operation level selection at disconnection	R/W	0 ~ 2	1
CE201	24401	5F51h	Second low current signal output mode selection	R/W	0 ~ 1	1
CE202	24402	5F52h	Second low current detection level 1	R/W	(0 to 2.00) * CTL rated current	0.1A
CE203	24403	5F53h	Second low current detection level 2	R/W	(0 to 2.00) * CTL rated current	0.1A
CE205	24405	5F55h	Second overload prewarning signal output mode selection	R/W	0 ~ 1	1
CE206	24406	5F56h	Second overload prewarning level 1	R/W	(0 to 2.00) * CTL rated current	0.1A
CE207	24407	5F57h	Second overload prewarning level 2	R/W	(0 to 2.00) * CTL rated current	0.1A
CE220	24420	5F64h	Second over torque level (normal powered)	R/W	0 ~ 5000	0.1%
CE221	24421	5F65h	Second over torque level (reverse regenerative)	R/W	0 ~ 5000	0.1%
CE222	24422	5F66h	Second over torque level (reverse powered)	R/W	0 ~ 5000	0.1%
CE223	24423	5F67h	Second over torque level (normal regenerative)	R/W	0 ~ 5000	0.1%



Function Code	Register No. (decimal)	Register No. (hexadecimal)	Function Name	R/W	Monitor Content and Setting Item	Data Resolution / Unit
CF-01	14501	38A5h	Communication transmission speed selection (baudrate selection)	R/W	3 ~ 10	1
CF-02	14502	38A6h	Communication station number selection	R/W	1 ~ 247	1
CF-03	14503	38A7h	Communication parity selection	R/W	0 ~ 2	1
CF-04	14504	38A8h	Communication stop bit selection	R/W	1 ~ 2	1
CF-05	14505	38A9h	Communication error selection	R/W	0 ~ 4	1
CF-06	14506	38Aah	Communication timeout time	R/W	0 ~ 10000	0.01s
CF-07	14507	38Abh	Communication waiting time	R/W	0 ~ 1000	1ms
CF-08	14508	38Ach	Communication method selection	R/W	1 ~ 3	1
<b>CF-11</b>	14511	38AFh	Resister data A, V $\leftrightarrow$ % conversion function	R/W	0 ~ 1	1
CF-20	14520	38B8h	EzCOM start INV station number	R/W	1 ~ 8	1
CF-21	14521	38B9h	EzCOM end INV station number	R/W	1 ~ 8	1
CF-22	14522	38Bah	EzCOM start selection	R/W	0 ~ 1	1
CF-23	14523	38BBh	Number of EzCOM data	R/W	1 ~ 5	1
CF-24	14524	38BCh	EzCOM transmission destination station number 1	R/W	1 ~ 247	1
CF-25	14525	38BDh	EzCOM transmission destination register 1	R/W	0 ~ 65535	1
CF-26	14526	38Beh	EzCOM transmission source register 1	R/W	0 ~ 65535	1
CF-27	14527	38BFh	EzCOM transmission destination station number 2	R/W	1 ~ 247	1
CF-28	14528	38C0h	EzCOM transmission destination register 2	R/W	0 ~ 65535	1
CF-29	14529	38C1h	EzCOM transmission source register 2	R/W	0 ~ 65535	1
CF-30	14530	38C2h	EzCOM transmission destination station number 3	R/W	1 ~ 247	1
CF-31	14531	38C3h	EzCOM transmission destination register 3	R/W	0 ~ 65535	1
CF-32	14532	38C4h	EzCOM transmission source register 3	R/W	0 ~ 65535	1
CF-33	14533	38C5h	EzCOM transmission destination station number 4	R/W	1 ~ 247	1
CF-34	14534	38C6h	EzCOM transmission destination register 4	R/W	0 ~ 65535	1
CF-35	14535	38C7h	EzCOM transmission source register 4	R/W	0 ~ 65535	1
CF-36	14536	38C8h	EzCOM transmission destination station number 5	R/W	1 ~ 247	1
CF-37	14537	38C9h	EzCOM transmission destination register 5	R/W	0 ~ 65535	1
CF-38	14538	38Cah	EzCOM transmission source register 5	R/W	0 ~ 65535	1
<b>CF-50</b>	14550	38D6h	USB station number selection	R/W	1 ~ 247	1

Function Code	Register No. (decimal)	Register No. (hexadecimal)	Function Name	R/W	Monitor Content and Setting Item	Data Resolution / Unit
HA-01	15001	3A99h	Auto-tuning selection	R/W	0 ~ 3	1
HA-02	15002	3A9Ah	Operation command for auto-tuning	R/W	0 ~ 1	1
HA-03	15003	3A9Bh	Online tuning selection	R/W	0 ~ 1	1
HA110	15010	3AA2h	First stability constant	R/W	0 ~ 1000	1%
HA115	15015	3AA7h	First speed response	R/W	0 ~ 1000	1%
HA120	15020	3AACh	First gain switch selection	R/W	0 ~ 1	1
HA121	15021	3AADh	First gain switch selection	R/W	0 ~ 10000	1ms
HA122	15022	3AAEh	First gain switch intermediate speed 1	R/W	0 ~ 59000	0.01Hz
HA123	15023	3AAFh	First gain switch intermediate speed 2	R/W	0 ~ 59000	0.01Hz
HA124	15024	3AB0h	First gain mapping maximum speed	R/W	0 ~ 59000	0.01Hz
HA125	15025	3AB1h	First gain mapping P gain 1	R/W	0 ~ 10000	0.1%
HA126	15026	3AB2h	First gain mapping I gain 1	R/W	0 ~ 10000	0.1%
HA127	15027	3AB3h	First gain mapping P control P gain 1	R/W	0 ~ 10000	0.1%
HA128	15028	3AB4h	First gain mapping P gain 2	R/W	0 ~ 10000	0.1%
HA129	15029	3AB5h	First gain mapping I gain 2	R/W	0 ~ 10000	0.1%
HA130	15030	3AB6h	First gain mapping P control P gain 2	R/W	0 ~ 10000	0.1%
HA131	15031	3AB7h	First gain mapping P gain 3	R/W	0 ~ 10000	0.1%
HA132	15032	3AB8h	First gain mapping I gain 3	R/W	0 ~ 10000	0.1%
HA133	15033	3AB9h	First gain mapping P gain 4	R/W	0 ~ 10000	0.1%
HA134	15034	3ABAh	First gain mapping I gain 4	R/W	0 ~ 10000	0.1%
HA210	25010	61B2h	Second stability constant (V/f, A.bst)	R/W	0 ~ 1000	1%
HA215	25015	61B7h	Second speed response	R/W	0 ~ 1000	1%
HA220	25020	61BCh	Second gain switch selection	R/W	0 ~ 1	1
HA221	25021	61BDh	Second gain switch time	R/W	0 ~ 10000	1ms
HA222	25022	61Beh	Second gain switch intermediate speed 1	R/W	0 ~ 59000	0.01Hz
HA223	25023	61BFh	Second gain switch intermediate speed 2	R/W	0 ~ 59000	0.01Hz
HA224	25024	61C0h	Second gain mapping maximum speed	R/W	0 ~ 59000	0.01Hz
HA225	25025	61C1h	Second gain mapping P gain 1	R/W	0 ~ 10000	0.1%
HA226	25026	61C2h	Second gain mapping I gain 1	R/W	0 ~ 10000	0.1%
HA227	25027	61C3h	Second gain mapping P control P gain 1	R/W	0 ~ 10000	0.1%
HA228	25028	61C4h	Second gain mapping P gain 2	R/W	0 ~ 10000	0.1%
HA229	25029	61C5h	Second gain mapping I gain 2	R/W	0 ~ 10000	0.1%
HA230	25030	61C6h	Second gain mapping P control P gain 2	R/W	0 ~ 10000	0.1%
HA231	25031	61C7h	Second gain mapping P gain 3	R/W	0 ~ 10000	0.1%
HA232	25032	61C8h	Second gain mapping I gain 3	R/W	0 ~ 10000	0.1%
HA233	25033	61C9h	Second gain mapping P gain 4	R/W	0 ~ 10000	0.1%
HA234	25034	61Cah	Second gain mapping I gain 4	R/W	0 ~ 10000	0.1%

Function Code	Register No. (decimal)	Register No. (hexadecimal)	Function Name	R/W	Monitor Content and Setting Item	Data Resolution / Unit
Hb102	15102	3AFEh	First IM motor capacity selection	R/W	1 ~ 16000	0.01kW
Hb103	15103	3AFFh	Selection of number of first IM motor poles	R/W	0 ~ 23	1
Hb104	15104	3B00h	First IM base frequency	R/W	1000 ~ 59000	0.01Hz
Hb105	15105	3B01h	First IM maximum frequency	R/W	1000 ~ 59000	0.01Hz
Hb106	15106	3B02h	First IM motor's rated voltage	R/W	1 ~ 1000	1V
Hb108	15108	3B04h	First IM motor's rated current (High)	R/W	1 ~ 1000000	0.01A
(Hb109)	15109	3B05h	(Low)			
Hb110	15110	3B06h	First IM motor constant R1 (High)	R/W	1 ~ 1000000000	0.000001Ω
(Hb111)	15111	3B07h	(Low)			
Hb112	15112	3B08h	First IM motor constant R2 (High)	R/W	1 ~ 1000000000	0.000001Ω
(Hb113)	15113	3B09h	(Low)			
Hb114	15114	3B0Ah	First IM motor constant L (High)	R/W	1 ~ 1000000000	0.000001mH
(Hb115)	15115	3B0Bh	(Low)			
Hb116	15116	3B0Ch	First IM motor constant lo (High)	R/W	1 ~ 1000000	0.01A
(Hb117)	15117	3B0Dh	(Low)			
Hb118	15118	3B0Eh	First IM motor constant J (High)	R/W	1 ~ 1000000000	0.00001kg·m <sup>2</sup>
(Hb119)	15119	3B0Fh	(Low)			
Hb130	15130	3B1Ah	First minimum frequency (V/f, A.bst, IM-SLV)	R/W	10 ~ 1000	0.01Hz
Hb131	15131	3B1Bh	First reduced voltage start time (V/f)	R/W	0 ~ 2000	1ms
Hb140	15140	3B24h	First manual torque boost operation mode selection	R/W	0 ~ 3	1
Hb141	15141	3B25h	First amount of manual torque boost (V/f)	R/W	0 ~ 200	0.1%
Hb142	15142	3B26h	First manual torque boost break point (V/f)	R/W	0 ~ 500	0.1%
Hb145	15145	3B29h	First energy-saving operation selection (V/f)	R/W	0 ~ 1	1
Hb146	15146	3B2Ah	First energy-saving response/accuracy adjustment (V/f)	R/W	0 ~ 100	1%
Hb150	15150	3B2Eh	First free V/f frequency 1	R/W	0 ~ 59000 (Hb152)	0.01Hz
Hb151	15151	3B2Fh	First free V/f voltage 1	R/W	0 ~ 10000	0.1V
Hb152	15152	3B30h	First free V/f frequency 2	R/W	0 ~ 59000 (Hb150)~(Hb154)	0.01Hz
Hb153	15153	3B31h	First free V/f voltage 2	R/W	0 ~ 10000	0.1V
Hb154	15154	3B32h	First free V/f frequency 3	R/W	0 ~ 59000 (Hb152)~(Hb156)	0.01Hz
Hb155	15155	3B33h	First free V/f voltage 3	R/W	0 ~ 10000	0.1V
Hb156	15156	3B34h	First free V/f frequency 4	R/W	0 ~ 59000 (Hb154)~(Hb158)	0.01Hz
Hb157	15157	3B35h	First free V/f voltage 4	R/W	0 ~ 10000	0.1V
Hb158	15158	3B36h	First free V/f frequency 5	R/W	0 ~ 59000 (Hb156)~(Hb160)	0.01Hz
Hb159	15159	3B37h	First free V/f voltage 5	R/W	0 ~ 10000	0.1V
Hb160	15160	3B38h	First free V/f frequency 6	R/W	0 ~ 59000 (Hb158)~(Hb162)	0.01Hz
Hb161	15161	3B39h	First free V/f voltage 6	R/W	0 ~ 10000	0.1V
Hb162	15162	3B3Ah	First free V/f frequency 7	R/W	0 ~ 59000 (Hb160)~(Hb104)	0.01Hz
Hb163	15163	3B3Bh	First free V/f voltage 7	R/W	0 ~ 10000	0.1V
<b>Hb170</b>	15170	3B42h	First slip compensation P gain with sensor (V/f, A.bst)	R/W	0 ~ 1000	1%
<b>Hb171</b>	15171	3B43h	First slip compensation I gain with sensor (V/f, A.bst)	R/W	0 ~ 1000	1%
Hb180	15180	3B4Ch	First output voltage gain (V/f)	R/W	0 ~ 255	1%

Function Code	Register No. (decimal)	Register No. (hexadecimal)	Function Name	R/W	Monitor Content and Setting Item	Data Resolution / Unit
Hb202	25102	620Eh	Second IM motor capacity selection	R/W	1 ~ 16000	0.01kW
Hb203	25103	620Fh	Selection of number of second IM motor poles	R/W	0 ~ 23	1
Hb204	25104	6210h	Second IM base frequency	R/W	1000 ~ 59000	0.01Hz
Hb205	25105	6211h	Second IM maximum frequency	R/W	1000 ~ 59000	0.01Hz
Hb206	25106	6212h	Second IM motor's rated voltage	R/W	1 ~ 1000	1V
Hb208	25108	6214h	Second IM motor's rated current (High)	R/W	1 ~ 1000000	0.01A
(Hb209)	25109	6215h	(Low)			
Hb210	25110	6216h	Second IM motor constant R1 (High)	R/W	1 ~ 1000000000	0.000001Ω
(Hb211)	25111	6217h	(Low)			
Hb212	25112	6218h	Second IM motor constant R2 (High)	R/W	1 ~ 1000000000	0.000001Ω
(Hb213)	25113	6219h	(Low)			
Hb214	25114	621Ah	Second IM motor constant L (High)	R/W	1 ~ 1000000000	0.000001mH
(Hb215)	25115	621Bh	(Low)			
Hb216	25116	621Ch	Second IM motor constant lo (High)	R/W	1 ~ 1000000	0.01A
(Hb217)	25117	621Dh	(Low)			
Hb218	25118	621Eh	Second IM motor constant J (High)	R/W	1 ~ 1000000000	0.00001kg·m <sup>2</sup>
(Hb219)	25119	621Fh	(Low)			
Hb230	25130	622Ah	Second minimum frequency (V/f, A.bst, IM-SLV)	R/W	10 ~ 1000	0.01Hz
Hb231	25131	622Bh	Second reduced voltage start time (V/f)	R/W	0 ~ 2000	1ms
Hb240	25140	6234h	Second manual torque boost operation mode selection	R/W	0 ~ 3	1
Hb241	25141	6235h	Second amount of manual torque boost (V/f)	R/W	0 ~ 200	0.1%
Hb242	25142	6236h	Second manual torque boost break point (V/f)	R/W	0 ~ 500	0.1%
Hb245	25145	6239h	Second energy-saving operation selection (V/f)	R/W	0 ~ 1	1
Hb246	25146	623Ah	Second energy-saving response/accuracy adjustment (V/f)	R/W	0 ~ 100	1%
Hb250	25150	623Eh	Second free V/f frequency 1	R/W	0 ~ 59000 (Hb252)	0.01Hz
Hb251	25151	623Fh	Second free V/f voltage 1	R/W	0 ~ 10000	0.1V
Hb252	25152	6240h	Second free V/f frequency 2	R/W	0 ~ 59000 (Hb250)~(Hb254)	0.01Hz
Hb253	25153	6241h	Second free V/f voltage 2	R/W	0 ~ 10000	0.1V
Hb254	25154	6242h	Second free V/f frequency 3	R/W	0 ~ 59000 (Hb252)~(Hb256)	0.01Hz
Hb255	25155	6243h	Second free V/f voltage 3	R/W	0 ~ 10000	0.1V
Hb256	25156	6244h	Second free V/f frequency 4	R/W	0 ~ 59000 (Hb254)~(Hb258)	0.01Hz
Hb257	25157	6245h	Second free V/f voltage 4	R/W	0 ~ 10000	0.1V
Hb258	25158	6246h	Second free V/f frequency 5	R/W	0 ~ 59000 (Hb256)~(Hb260)	0.01Hz
Hb259	25159	6247h	Second free V/f voltage 5	R/W	0 ~ 10000	0.1V
Hb260	25160	6248h	Second free V/f frequency 6	R/W	0 ~ 59000 (Hb258)~(Hb262)	0.01Hz
Hb261	25161	6249h	Second free V/f voltage 6	R/W	0 ~ 10000	0.1V
Hb262	25162	624Ah	Second free V/f frequency 7	R/W	0 ~ 59000 (Hb260)~(Hb204)	0.01Hz
Hb263	25163	624Bh	Second free V/f voltage 7	R/W	0 ~ 10000	0.1V
<b>Hb270</b>	25170	6252h	Second slip compensation P gain with sensor (V/f, A.bst)	R/W	0 ~ 1000	1%
<b>Hb271</b>	25171	6253h	Second slip compensation I gain with sensor (V/f, A.bst)	R/W	0 ~ 1000	1%
Hb280	25180	625Ch	Second output voltage gain (V/f)	R/W	0 ~ 255	1%

Function Code	Register No. (decimal)	Register No. (hexadecimal)	Function Name	R/W	Monitor Content and Setting Item	Data Resolution / Unit
HC101	15201	3B61h	First automatic torque boost voltage compensation gain	R/W	0 ~ 255	1%
HC102	15202	3B62h	First automatic torque boost slip compensation gain	R/W	0 ~ 255	1%
HC110	15210	3B6Ah	First zero-speed range limiter (IM-0Hz-SLV)	R/W	0 ~ 100	1%
HC111	15211	3B6Bh	First amount of boost at the start (IM-SLV)	R/W	0 ~ 50	1%
HC112	15212	3B6Ch	First amount of boost at the start (IM-0Hz-SLV)	R/W	0 ~ 50	1%
HC113	15213	3B6Dh	First selection of whether a secondary-resistance correction is to be conducted (IM-SLV, IM-0Hz-SLV, IM-CLV)	R/W	0 ~ 1	1
HC114	15214	3B6Eh	First selection of reversal prevention (IM-SLV, IM-0Hz-SLV, IM-CLV)	R/W	0 ~ 1	1
HC120	15220	3B74h	First time constant for torque current command filter (IM-SLV, IM-0Hz-SLV, IM-CLV, SM-CLV)	R/W	0 ~ 100	1ms
HC121	15221	3B75h	First speed feed forward compensation adjustment gain (IM-SLV, IM-0Hz-SLV, IM-CLV, SM-CLV)	R/W	0 ~ 1000	1%
HC201	25201	6271h	Second automatic torque boost voltage compensation gain	R/W	0 ~ 255	1%
HC202	25202	6272h	Second automatic torque boost slip compensation gain	R/W	0 ~ 255	1%
HC210	25210	627Ah	Second zero-speed range limiter (IM-0Hz-SLV)	R/W	0 ~ 100	1%
HC211	25211	627Bh	Second amount of boost at the start (IM-SLV)	R/W	0 ~ 50	1%
HC212	25212	627Ch	Second amount of boost at the start (IM-0Hz-SLV)	R/W	0 ~ 50	1%
HC213	25213	627Dh	Second selection of whether a secondary-resistance correction is to be conducted (IM-SLV, IM-0Hz-SLV, IM-CLV)	R/W	0 ~ 1	1
HC214	25214	627Eh	Second selection of reversal prevention (IM-SLV, IM-0Hz-SLV, IM-CLV)	R/W	0 ~ 1	1
HC220	25220	6284h	Second time constant for torque current command filter (IM-SLV, IM-0Hz-SLV, IM-CLV, SM-CLV)	R/W	0 ~ 100	1ms
HC221	25221	6285h	Second speed feed forward compensation adjustment gain (IM-SLV, IM-0Hz-SLV, IM-CLV, SM-CLV)	R/W	0 ~ 1000	1%

Function Code	Register No. (decimal)	Register No. (hexadecimal)	Function Name	R/W	Monitor Content and Setting Item	Data Resolution / Unit
Hd102	15302	3BC6h	First SM (PMM) motor capacity selection	R/W	1 ~ 16000	0.01kW
Hd103	15303	3BC7h	First selection of number of SM (PMM) motor poles	R/W	0 ~ 23	1
Hd104	15304	3BC8h	First SM (PMM) base frequency	R/W	1000 ~ 59000	0.01Hz
Hd105	15305	3BC9h	First SM (PMM) maximum frequency	R/W	1000 ~ 59000	0.01Hz
Hd106	15306	3BCAh	First SM (PMM) motor's rated voltage	R/W	1 ~ 1000	1V
Hd108	15308	3BCCh	First SM (PMM) motor's rated current (High)	R/W	1 ~ 1000000	0.01A
(Hd109)	15309	3BCDh	(Low)			
Hd110	15310	3BCEh	First SM (PMM) motor's constant R (High)	R/W	1 ~ 1000000000	0.000001Ω
(Hd111)	15311	3BCFh	(Low)			
Hd112	15312	3BD0h	First SM (PMM) motor's constant Ld (High)	R/W	1 ~ 1000000000	0.000001mH
(Hd113)	15313	3BD1h	(Low)			
Hd114	15314	3BD2h	First SM (PMM) motor's constant Lq (High)	R/W	1 ~ 1000000000	0.000001mH
(Hd115)	15315	3BD3h	(Low)			
Hd116	15316	3BD4h	First SM (PMM) motor's constant Ke (High)	R/W	1 ~ 1000000	0.1mVs/rad
(Hd117)	15317	3BD5h	(Low)			
Hd118	15318	3BD6h	First SM (PMM) motor's constant J (High)	R/W	1 ~ 1000000000	0.00001 kg·m <sup>2</sup>
(Hd119)	15319	3BD7h	(Low)			
Hd130	15330	3BE2h	First SM minimum frequency (switch) (SM-SLV, SM-IVMS)	R/W	0 ~ 50	1%
Hd131	15331	3BE3h	First SM no-load current (SM-SLV, SM-IVMS)	R/W	0 ~ 100	1%
Hd132	15332	3BE4h	First SM start method selection (SM-SLV, SM-IVMS, SM-CLV)	R/W	0 ~ 1	1
Hd133	15333	3BE5h	First SM initial position estimation zero-V stand-by times (SM-SLV, SM-IVMS, SM-CLV)	R/W	0 ~ 255	1
Hd134	15334	3BE6h	First SM initial position estimation detection stand-by times (SM-SLV, SM-IVMS, SM-CLV)	R/W	0 ~ 255	1
Hd135	15335	3BE7h	First SM initial position estimation detection times (SM-SLV, SM-IVMS, SM-CLV)	R/W	0 ~ 255	1
Hd136	15336	3BE8h	First SM initial position estimation voltage gain (SM-SLV, SM-IVMS, SM-CLV)	R/W	0 ~ 200	1%
Hd137	15337	3BE9h	First SM initial position estimation magnetic-pole position offset (SM-SLV, SM-IVMS, SM-CLV)	R/W	0 ~ 359	1deg
<b>Hd-41</b>	15341	3BEDh	IVMS carrier frequency	R/W	5 ~ 160	0.1kHz
<b>Hd-42</b>	15342	3BEEh	Filter gain of IVMS detection current	R/W	0 ~ 1000	1
<b>Hd-43</b>	15343	3BEFh	Open-phase voltage detection gain selection.	R/W	0 ~ 3	1
<b>Hd-44</b>	15344	3BF0h	Selection of open-phase switch threshold correction.	R/W	0 ~ 1	1
<b>Hd-45</b>	15345	3BF1h	Speed control P gain	R/W	0 ~ 1000	1
<b>Hd-46</b>	15346	3BF2h	Speed control I gain	R/W	0 ~ 10000	1
<b>Hd-47</b>	15347	3BF3h	Waiting time for open-phase switching	R/W	0 ~ 1000	1
<b>Hd-48</b>	15348	3BF4h	Restriction on the rotation-direction determination	R/W	0 ~ 1	1
<b>Hd-49</b>	15349	3BF5h	Adjustment of the timing for detecting the open-phase voltage	R/W	0 ~ 1000	1
<b>Hd-50</b>	15350	3BF6h	Minimum pulse width adjustment	R/W	0 ~ 1000	1
<b>Hd-51</b>	15351	3BF7h	Current limit of IVMS threshold	R/W	0 ~ 255	1
<b>Hd-52</b>	15352	3BF8h	IVMS threshold gain	R/W	0 ~ 255	1
<b>Hd-58</b>	15358	3BFEh	IVMS carrier-frequency switching start/finish point	R/W	0 ~ 50	1%

Function Code	Register No. (decimal)	Register No. (hexadecimal)	Function Name	R/W	Monitor Content and Setting Item	Data Resolution / Unit
Hd202	25302	62D6h	Second SM (PMM) motor capacity selection	R/W	1 ~ 16000	0.01kW
Hd203	25303	62D7h	Second selection of number of SM (PMM) motor poles	R/W	0 ~ 23	1
Hd204	25304	62D8h	Second SM (PMM) base frequency	R/W	1000 ~ 59000	0.01Hz
Hd205	25305	62D9h	Second SM (PMM) maximum frequency	R/W	1000 ~ 59000	0.01Hz
Hd206	25306	62Dah	Second SM (PMM) motor's rated voltage	R/W	1 ~ 1000	1V
Hd208	25308	62DCh	Second SM (PMM) motor's rated current (High)	R/W	1 ~ 1000000	0.01A
(Hd209)	25309	62DDh	(Low)			
Hd210	25310	62Deh	Second SM (PMM) motor's constant R (High)	R/W	1 ~ 1000000000	0.000001Ω
(Hd211)	25311	62DFh	(Low)			
Hd212	25312	62E0h	Second SM (PMM) motor's constant Ld (High)	R/W	1 ~ 1000000000	0.000001mH
(Hd213)	25313	62E1h	(Low)			
Hd214	25314	62E2h	Second SM (PMM) motor's constant Lq (High)	R/W	1 ~ 1000000000	0.000001mH
(Hd215)	25315	62E3h	(Low)			
Hd216	25316	62E4h	Second SM (PMM) motor's constant Ke (High)	R/W	1 ~ 1000000	0.1mVs/rad
(Hd217)	25317	62E5h	(Low)			
Hd218	25318	62E6h	Second SM (PMM) motor's constant J (High)	R/W	1 ~ 1000000000	0.00001 kg·m <sup>2</sup>
(Hd219)	25319	62E7h	(Low)			
Hd230	25330	62F2h	Second SM minimum frequency (switch) (SM-SLV, SM-IVMS)	R/W	0 ~ 50	1%
Hd231	25331	62F3h	Second SM no-load current (SM-SLV, SM-IVMS)	R/W	0 ~ 100	1%
Hd232	25332	62F4h	First SM start method selection (SM-SLV, SM-IVMS, SM-CLV)	R/W	0 ~ 1	1
Hd233	25333	62F5h	Second SM initial position estimation zero-V stand-by times (SM-SLV, SM-IVMS, SM-CLV)	R/W	0 ~ 255	1
Hd234	25334	62F6h	Second SM initial position estimation detection stand-by times (SM-SLV, SM-IVMS, SM-CLV)	R/W	0 ~ 255	1
Hd235	25335	62F7h	Second SM initial position estimation detection times (SM-SLV, SM-IVMS, SM-CLV)	R/W	0 ~ 255	1
Hd236	25336	62F8h	Second SM initial position estimation voltage gain (SM-SLV, SM-IVMS, SM-CLV)	R/W	0 ~ 200	1%
Hd237	25337	62F9h	Second SM initial position estimation magnetic-pole position offset (SM-SLV, SM-IVMS, SM-CLV)	R/W	0 ~ 359	1deg

Function Code	Register No. (decimal)	Register No. (hexadecimal)	Function Name	R/W	Monitor Content and Setting Item	Data Resolution / Unit
oA-10	16010	3E8Ah	Operation selection when option error occurs (SLOT-1)	R/W	0 ~ 1	1
oA-11	16011	3E8Bh	Communication monitoring timer setting	R/W	0 ~ 10000	0.01s
oA-12	16012	3E8Ch	Operation setting at the time of communication error	R/W	0 ~ 4	1
oA-13	16013	3E8Dh	Selection of operation command behavior at start of option (SLOT-1)	R/W	0 ~ 1	1
oA-20	16020	3E94h	Operation selection when option error occurs (SLOT-2)	R/W	0 ~ 1	1
oA-21	16021	3E95h	Communication monitoring timer setting	R/W	0 ~ 10000	0.01s
oA-22	16022	3E96h	Operation setting at the time of communication error	R/W	0 ~ 4	1
oA-23	16023	3E97h	Selection of operation command behavior at start of option (SLOT-2)	R/W	0 ~ 1	1
oA-30	16030	3E9Eh	Operation selection when option error occurs (SLOT-3)	R/W	0 ~ 1	1
oA-31	16031	3E9Fh	Communication monitoring timer setting	R/W	0 ~ 10000	0.01s
oA-32	16032	3EA0h	Operation setting at the time of communication error	R/W	0 ~ 4	1
oA-33	16033	3EA1h	Selection of operation command behavior at start of option (SLOT-3)	R/W	0 ~ 1	1
ob-01	16101	3EE5h	Encoder constant set-up (option)	R/W	32 ~ 65535	1pls
ob-02	16102	3EE6h	Encoder phase sequence selection (option)	R/W	0 ~ 1	1
ob-03	16103	3EE7h	Motor gear ratio's numerator (option)	R/W	1 ~ 10000	1
ob-04	16104	3EE8h	Motor gear ratio's denominator (option)	R/W	1 ~ 10000	1
ob-10	16110	3EEh	Pulse train input SA/SB (option) detection target selection	R/W	0 ~ 1	1
ob-11	16111	3EEFh	Pulse train input SA/SB (option) mode selection	R/W	0 ~ 2	1
ob-12	16112	3EF0h	Pulse train frequency scale (option)	R/W	5 ~ 20000	0.01kHz
ob-13	16113	3EF1h	Pulse train frequency filter time constant (option)	R/W	1 ~ 200	0.01s
ob-14	16114	3EF2h	Pulse train frequency bias amount (option)	R/W	-1000 ~ 1000	0.1%
ob-15	16115	3EF3h	Pulse train frequency detection upper limit (option)	R/W	0 ~ 1000	0.1%
ob-16	16116	3EF4h	Pulse train frequency detection lower level (option)	R/W	0 ~ 1000	0.1%
oC-01	16201	3F49h	Safety-option input indication selection	R/W	0 ~ 1	1
oC-10	16210	3F52h	SS1-A deceleration time (High)	R/W	0 ~ 360000	0.01s
(oC-11)	16211	3F53h	(Low)			
oC-12	16212	3F54h	SLS-A deceleration time (High)	R/W	0 ~ 360000	0.01s
(oC-13)	16213	3F55h	(Low)			
oC-14	16214	3F56h	SLS-A speed upper limit: normal rotation	R/W	0 ~ 59000	0.01Hz
oC-15	16215	3F57h	SLS-A speed upper limit: reverse rotation	R/W	0 ~ 59000	0.01Hz
oC-16	16216	3F58h	SDI-A deceleration time (High)	R/W	0 ~ 360000	0.01s
(oC-17)	16217	3F59h	(Low)			
oC-18	16218	3F5Ah	SDI-A restriction direction	R/W	0 ~ 1	1
oC-20	16220	3F5Ch	SS1-B deceleration time (High)	R/W	0 ~ 360000	0.01s
(oC-21)	16221	3F5Dh	(Low)			
oC-22	16222	3F5Eh	SLS-B deceleration time (High)	R/W	0 ~ 360000	0.01s
(oC-23)	16223	3F5Fh	(Low)			
oC-24	16224	3F60h	SLS-B speed upper limit: normal rotation	R/W	0 ~ 59000	0.01Hz
oC-25	16225	3F61h	SLS-B speed upper limit: reverse rotation	R/W	0 ~ 59000	0.01Hz
oC-26	16226	3F62h	SDI-B deceleration time (High)	R/W	0 ~ 360000	0.01s
(oC-27)	16227	3F63h	(Low)			
oC-28	16228	3F64h	SDI-B restriction direction	R/W	0 ~ 1	1



Function Code	Register No. (decimal)	Register No. (hexadecimal)	Function Name	R/W	Monitor Content and Setting Item	Data Resolution / Unit
oE-01	16401	4011h	[Ai4] terminal input filter time constant	R/W	1 ~ 500	1ms
oE-03	16403	4013h	[Ai4] terminal start amount	R/W	0 ~ 10000	0.01%
oE-04	16404	4014h	[Ai4] terminal end amount	R/W	0 ~ 10000	0.01%
oE-05	16405	4015h	[Ai4] terminal start ratio	R/W	0 ~ 1000 (oE-06)	0.1%
oE-06	16406	4016h	[Ai4] terminal end ratio	R/W	(oE-05) 0 ~ 1000	0.1%
oE-07	16407	4017h	[Ai4] terminal start selection	R/W	0 ~ 1	1
oE-11	16411	401Bh	[Ai5] terminal input filter time constant	R/W	1 ~ 500	1ms
oE-13	16413	401Dh	[Ai5] terminal start amount	R/W	0 ~ 10000	0.01%
oE-14	16414	401Eh	[Ai5] terminal end amount	R/W	0 ~ 10000	0.01%
oE-15	16415	401Fh	[Ai5] terminal start ratio	R/W	0 ~ 1000 (oE-16)	0.1%
oE-16	16416	4020h	[Ai5] terminal end ratio	R/W	(oE-15) 0 ~ 1000	0.1%
oE-17	16417	4021h	[Ai5] terminal start selection	R/W	0 ~ 1	1
oE-21	16421	4025h	[Ai6] terminal input filter time constant	R/W	1 ~ 500	1ms
oE-23	16423	4027h	[Ai6] terminal start amount	R/W	-10000 ~ 10000	0.01%
oE-24	16424	4028h	[Ai6] terminal end amount	R/W	-10000 ~ 10000	0.01%
oE-25	16425	4029h	[Ai6] terminal start ratio	R/W	-1000 ~ 1000 (oE-26)	0.1%
oE-26	16426	402Ah	[Ai6] terminal end ratio	R/W	(oE-25) -1000 ~ 1000	0.1%
oE-28	16428	402Ch	[Ai4] voltage/current bias adjustment	R/W	-10000 ~ 10000	0.01%
oE-29	16429	402Dh	[Ai4] voltage/current adjustment gain	R/W	0 ~ 20000	0.01%
oE-30	16430	402Eh	[Ai5] voltage/current bias adjustment	R/W	-10000 ~ 10000	0.01%
oE-31	16431	402Fh	[Ai5] voltage/current adjustment gain	R/W	0 ~ 20000	0.01%
oE-32	16432	4030h	[Ai6] voltage bias adjustment	R/W	-10000 ~ 10000	0.01%
oE-33	16433	4031h	[Ai6] voltage adjustment gain	R/W	0 ~ 20000	0.01%
oE-35	16435	4033h	Window comparator [Ai4] upper limit level	R/W	0 ~ 100	1%
oE-36	16436	4034h	Window comparator [Ai4] lower limit level	R/W	0 ~ 100	1%
oE-37	16437	4035h	Window comparator [Ai4] hysteresis range	R/W	0 ~ 10	1%
oE-38	16438	4036h	Window comparator [Ai5] upper limit level	R/W	0 ~ 100	1%
oE-39	16439	4037h	Window comparator [Ai5] lower limit level	R/W	0 ~ 100	1%
oE-40	16440	4038h	Window comparator [Ai5] hysteresis range	R/W	0 ~ 10	1%
oE-41	16441	4039h	Window comparator [Ai6] upper limit level	R/W	-100 ~ 100	1%
oE-42	16442	403Ah	Window comparator [Ai6] lower limit level	R/W	-100 ~ 100	1%
oE-43	16443	403Bh	Window comparator [Ai6] hysteresis range	R/W	0 ~ 10	1%
oE-44	16444	403Ch	[Ai4] operation level at disconnection	R/W	0 ~ 100	1%
oE-45	16445	403Dh	[Ai4] operation level selection at disconnection	R/W	0 ~ 2	1
oE-46	16446	403Eh	[Ai5] operation level at disconnection	R/W	0 ~ 100	1%
oE-47	16447	403Fh	[Ai5] operation level selection at disconnection	R/W	0 ~ 2	1
oE-48	16448	4040h	[Ai6] operation level at disconnection	R/W	-100 ~ 100	1%
oE-49	16449	4041h	[Ai6] operation level selection at disconnection	R/W	0 ~ 2	1

Function Code	Register No. (decimal)	Register No. (hexadecimal)	Function Name	R/W	Monitor Content and Setting Item	Data Resolution / Unit
<b>oE-50</b>	16450	4042h	[Ao3] terminal output selection	R/W	0 to 65535 (register No.)	1
<b>oE-51</b>	16451	4043h	[Ao4] terminal output selection	R/W	0 to 65535 (register No.)	1
<b>oE-52</b>	16452	4044h	[Ao5] terminal output selection	R/W	0 to 65535 (register No.)	1
<b>oE-56</b>	16456	4048h	[Ao3] output filter time constant	R/W	1 ~ 500	1ms
<b>oE-57</b>	16457	4049h	[Ao3] terminal sign selection	R/W	0 ~ 1	1
<b>oE-58</b>	16458	404Ah	[Ao3] bias adjustment (voltage/current)	R/W	-1000 ~ 1000	0.1%
<b>oE-59</b>	16459	404Bh	[Ao3] gain adjustment (voltage/current)	R/W	-10000 ~ 10000	0.1%
<b>oE-60</b>	16460	404Ch	[Ao3] output level in the adjustment mode	R/W	-1000 ~ 1000	0.1%
<b>oE-61</b>	16461	404Dh	[Ao4] output filter time constant	R/W	1 ~ 500	1ms
<b>oE-62</b>	16462	404Eh	[Ao4] output data type selection	R/W	0 ~ 1	1
<b>oE-63</b>	16463	404Fh	[Ao4] bias adjustment (voltage/current)	R/W	-1000 ~ 1000	0.1%
<b>oE-64</b>	16464	4050h	[Ao4] gain adjustment (voltage/current)	R/W	-10000 ~ 10000	0.1%
<b>oE-65</b>	16465	4051h	[Ao4] output level in the adjustment mode	R/W	-1000 ~ 1000	0.1%
<b>oE-66</b>	16466	4052h	[Ao5] output filter time constant	R/W	1 ~ 500	1ms
<b>oE-67</b>	16467	4053h	[Ao5] output data type selection	R/W	0 ~ 1	1
<b>oE-68</b>	16468	4054h	[Ao5] bias adjustment (voltage)	R/W	-1000 ~ 1000	0.1%
<b>oE-69</b>	16469	4055h	[Ao5] gain adjustment (voltage)	R/W	-10000 ~ 10000	0.1%
<b>oE-70</b>	16470	4056h	[Ao5] output level in the adjustment mode	R/W	-1000 ~ 1000	0.1%
<b>oH-01</b>	16701	413Dh	IP address selection (P1-EN)	R/W	0 ~ 1	1
<b>oH-02</b>	16702	413Eh	Transmission speed (port 1) (P1-EN)	R/W	0 ~ 4	1
<b>oH-03</b>	16703	413Fh	Transmission speed (port 2) (P1-EN)	R/W	0 ~ 4	1
<b>oH-04</b>	16704	4140h	Ethernet communication timeout (P1-EN)	R/W	1 ~ 65535	1 (*10ms)
<b>oH-05</b>	16705	4141h	Modbus TCP port number (IPv4)	R/W	502,1024 ~ 65535	1
<b>oH-06</b>	16706	4142h	Modbus TCP port number (IPv6)	R/W	502,1024 ~ 65535	1
<b>oH-20</b>	16720	4150h	Profibus Node address	R/W	0 ~ 125	1
<b>oH-21</b>	16721	4151h	Profibus Clear Mode selection	R/W	0 ~ 1	1
<b>oH-22</b>	16722	4152h	Profibus Map selection	R/W	0 ~ 2	1
<b>oH-23</b>	16723	4153h	Selection of setting from the Profibus master	R/W	0 ~ 1	1
<b>oH-24</b>	16724	4154h	Selection of setpoint telegram/Actual value telegram Gr (P1-PB)	R/W	0 ~ 2	1
<b>oH-30</b>	16730	415Ah	IP address selection (P1-PN)	R/W	0 ~ 1	1
<b>oH-31</b>	16731	415Bh	Transmission speed (port 1) (P1-PN)	R/W	0 ~ 4	1
<b>oH-32</b>	16732	415Ch	Transmission speed (port 2) (P1-PN)	R/W	0 ~ 4	1
<b>oH-33</b>	16733	415Dh	Ethernet communication timeout (P1-PN)	R/W	1 ~ 65535	1 (*10ms)
<b>oH-34</b>	16734	415Eh	Selection of setpoint telegram/Actual value telegram Gr (P1-PN)	R/W	0 ~ 2	1

Function Code	Register No. (decimal)	Register No. (hexadecimal)	Function Name	R/W	Monitor Content and Setting Item	Data Resolution / Unit
oJ-01	16801	41A1h	Gr.A flexible command registration writing register 1	R/W	0 ~ 65535	1
oJ-02	16802	41A2h	Gr.A flexible command registration writing register 2	R/W	0 ~ 65535	1
oJ-03	16803	41A3h	Gr.A flexible command registration writing register 3	R/W	0 ~ 65535	1
oJ-04	16804	41A4h	Gr.A flexible command registration writing register 4	R/W	0 ~ 65535	1
oJ-05	16805	41A5h	Gr.A flexible command registration writing register 5	R/W	0 ~ 65535	1
oJ-06	16806	41A6h	Gr.A flexible command registration writing register 6	R/W	0 ~ 65535	1
oJ-07	16807	41A7h	Gr.A flexible command registration writing register 7	R/W	0 ~ 65535	1
oJ-08	16808	41A8h	Gr.A flexible command registration writing register 8	R/W	0 ~ 65535	1
oJ-09	16809	41A9h	Gr.A flexible command registration writing register 9	R/W	0 ~ 65535	1
oJ-10	16810	41AAh	Gr.A flexible command registration writing register 10	R/W	0 ~ 65535	1
oJ-11	16811	41ABh	Gr.A flexible command registration reading register 1	R/W	0 ~ 65535	1
oJ-12	16812	41ACh	Gr.A flexible command registration reading register 2	R/W	0 ~ 65535	1
oJ-13	16813	41ADh	Gr.A flexible command registration reading register 3	R/W	0 ~ 65535	1
oJ-14	16814	41AEh	Gr.A flexible command registration reading register 4	R/W	0 ~ 65535	1
oJ-15	16815	41AFh	Gr.A flexible command registration reading register 5	R/W	0 ~ 65535	1
oJ-16	16816	41B0h	Gr.A flexible command registration reading register 6	R/W	0 ~ 65535	1
oJ-17	16817	41B1h	Gr.A flexible command registration reading register 7	R/W	0 ~ 65535	1
oJ-18	16818	41B2h	Gr.A flexible command registration reading register 8	R/W	0 ~ 65535	1
oJ-19	16819	41B3h	Gr.A flexible command registration reading register 9	R/W	0 ~ 65535	1
oJ-20	16820	41B4h	Gr.A flexible command registration reading register 10	R/W	0 ~ 65535	1
oJ-21	16821	41B5h	Gr.B flexible command registration writing register 1	R/W	0 ~ 65535	1
oJ-22	16822	41B6h	Gr.B flexible command registration writing register 2	R/W	0 ~ 65535	1
oJ-23	16823	41B7h	Gr.B flexible command registration writing register 3	R/W	0 ~ 65535	1
oJ-24	16824	41B8h	Gr.B flexible command registration writing register 4	R/W	0 ~ 65535	1
oJ-25	16825	41B9h	Gr.B flexible command registration writing register 5	R/W	0 ~ 65535	1
oJ-26	16826	41BAh	Gr.B flexible command registration writing register 6	R/W	0 ~ 65535	1
oJ-27	16827	41BBh	Gr.B flexible command registration writing register 7	R/W	0 ~ 65535	1
oJ-28	16828	41BCh	Gr.B flexible command registration writing register 8	R/W	0 ~ 65535	1
oJ-29	16829	41BDh	Gr.B flexible command registration writing register 9	R/W	0 ~ 65535	1
oJ-30	16830	41BEh	Gr.B flexible command registration writing register 10	R/W	0 ~ 65535	1
oJ-31	16831	41BFh	Gr.B flexible command registration reading register 1	R/W	0 ~ 65535	1
oJ-32	16832	41C0h	Gr.B flexible command registration reading register 2	R/W	0 ~ 65535	1
oJ-33	16833	41C1h	Gr.B flexible command registration reading register 3	R/W	0 ~ 65535	1
oJ-34	16834	41C2h	Gr.B flexible command registration reading register 4	R/W	0 ~ 65535	1
oJ-35	16835	41C3h	Gr.B flexible command registration reading register 5	R/W	0 ~ 65535	1
oJ-36	16836	41C4h	Gr.B flexible command registration reading register 6	R/W	0 ~ 65535	1
oJ-37	16837	41C5h	Gr.B flexible command registration reading register 7	R/W	0 ~ 65535	1
oJ-38	16838	41C6h	Gr.B flexible command registration reading register 8	R/W	0 ~ 65535	1
oJ-39	16839	41C7h	Gr.B flexible command registration reading register 9	R/W	0 ~ 65535	1
oJ-40	16840	41C8h	Gr.B flexible command registration reading register 10	R/W	0 ~ 65535	1

Function Code	Register No. (decimal)	Register No. (hexadecimal)	Function Name	R/W	Monitor Content and Setting Item	Data Resolution / Unit
<b>oJ-41</b>	16841	41C9h	Gr.C flexible command registration writing register 1	R/W	0 ~ 65535	1
<b>oJ-42</b>	16842	41CAh	Gr.C flexible command registration writing register 2	R/W	0 ~ 65535	1
<b>oJ-43</b>	16843	41CBh	Gr.C flexible command registration writing register 3	R/W	0 ~ 65535	1
<b>oJ-44</b>	16844	41CCh	Gr.C flexible command registration writing register 4	R/W	0 ~ 65535	1
<b>oJ-45</b>	16845	41CDh	Gr.C flexible command registration writing register 5	R/W	0 ~ 65535	1
<b>oJ-46</b>	16846	41CEh	Gr.C flexible command registration writing register 6	R/W	0 ~ 65535	1
<b>oJ-47</b>	16847	41CFh	Gr.C flexible command registration writing register 7	R/W	0 ~ 65535	1
<b>oJ-48</b>	16848	41D0h	Gr.C flexible command registration writing register 8	R/W	0 ~ 65535	1
<b>oJ-49</b>	16849	41D1h	Gr.C flexible command registration writing register 9	R/W	0 ~ 65535	1
<b>oJ-50</b>	16850	41D2h	Gr.C flexible command registration writing register 10	R/W	0 ~ 65535	1
<b>oJ-51</b>	16851	41D3h	Gr.C flexible command registration reading register 1	R/W	0 ~ 65535	1
<b>oJ-52</b>	16852	41D4h	Gr.C flexible command registration reading register 2	R/W	0 ~ 65535	1
<b>oJ-53</b>	16853	41D5h	Gr.C flexible command registration reading register 3	R/W	0 ~ 65535	1
<b>oJ-54</b>	16854	41D6h	Gr.C flexible command registration reading register 4	R/W	0 ~ 65535	1
<b>oJ-55</b>	16855	41D7h	Gr.C flexible command registration reading register 5	R/W	0 ~ 65535	1
<b>oJ-56</b>	16856	41D8h	Gr.C flexible command registration reading register 6	R/W	0 ~ 65535	1
<b>oJ-57</b>	16857	41D9h	Gr.C flexible command registration reading register 7	R/W	0 ~ 65535	1
<b>oJ-58</b>	16858	41DAh	Gr.C flexible command registration reading register 8	R/W	0 ~ 65535	1
<b>oJ-59</b>	16859	41DBh	Gr.C flexible command registration reading register 9	R/W	0 ~ 65535	1
<b>oJ-60</b>	16860	41DCh	Gr.C flexible command registration reading register 10	R/W	0 ~ 65535	1
oL-01	16901	4205h	Gr.1 IPv4 IP address (1)	R/W	0 ~ 255	1
oL-02	16902	4206h	Gr.1 IPv4 IP address (2)	R/W	0 ~ 255	1
oL-03	16903	4207h	Gr.1 IPv4 IP address (3)	R/W	0 ~ 255	1
oL-04	16904	4208h	Gr.1 IPv4 IP address (4)	R/W	0 ~ 255	1
oL-05	16905	4209h	Gr.1 IPv4 subnet mask (1)	R/W	0 ~ 255	1
oL-06	16906	420Ah	Gr.1 IPv4 subnet mask (2)	R/W	0 ~ 255	1
oL-07	16907	420Bh	Gr.1 IPv4 subnet mask (3)	R/W	0 ~ 255	1
oL-08	16908	420Ch	Gr.1 IPv4 subnet mask (4)	R/W	0 ~ 255	1
oL-09	16909	420Dh	Gr.1 IPv4 default gateway (1)	R/W	0 ~ 255	1
oL-10	16910	420Eh	Gr.1 IPv4 default gateway (2)	R/W	0 ~ 255	1
oL-11	16911	420Fh	Gr.1 IPv4 default gateway (3)	R/W	0 ~ 255	1
oL-12	16912	4210h	Gr.1 IPv4 default gateway (4)	R/W	0 ~ 255	1
oL-20	16920	4218h	Gr.1 IPv6 IP address (1)	R/W	0 ~ 65535	1
oL-21	16921	4219h	Gr.1 IPv6 IP address (2)	R/W	0 ~ 65535	1
oL-22	16922	421Ah	Gr.1 IPv6 IP address (3)	R/W	0 ~ 65535	1
oL-23	16923	421Bh	Gr.1 IPv6 IP address (4)	R/W	0 ~ 65535	1
oL-24	16924	421Ch	Gr.1 IPv6 IP address (5)	R/W	0 ~ 65535	1
oL-25	16925	421Dh	Gr.1 IPv6 IP address (6)	R/W	0 ~ 65535	1
oL-26	16926	421Eh	Gr.1 IPv6 IP address (7)	R/W	0 ~ 65535	1
oL-27	16927	421Fh	Gr.1 IPv6 IP address (8)	R/W	0 ~ 65535	1
oL-28	16928	4220h	Gr.1 IPv6 subnet prefix	R/W	0 ~ 127	1

Function Code	Register No. (decimal)	Register No. (hexadecimal)	Function Name	R/W	Monitor Content and Setting Item	Data Resolution / Unit
oL-29	16929	4221h	Gr.1 IPv6 default gateway (1)	R/W	0 ~ 65535	1
oL-30	16930	4222h	Gr.1 IPv6 default gateway (2)	R/W	0 ~ 65535	1
oL-31	16931	4223h	Gr.1 IPv6 default gateway (3)	R/W	0 ~ 65535	1
oL-32	16932	4224h	Gr.1 IPv6 default gateway (4)	R/W	0 ~ 65535	1
oL-33	16933	4225h	Gr.1 IPv6 default gateway (5)	R/W	0 ~ 65535	1
oL-34	16934	4226h	Gr.1 IPv6 default gateway (6)	R/W	0 ~ 65535	1
oL-35	16935	4227h	Gr.1 IPv6 default gateway (7)	R/W	0 ~ 65535	1
oL-36	16936	4228h	Gr.1 IPv6 default gateway (8)	R/W	0 ~ 65535	1
oL-40	16940	422Ch	Gr.2 IPv4 IP address (1)	R/W	0 ~ 255	1
oL-41	16941	422Dh	Gr.2 IPv4 IP address (2)	R/W	0 ~ 255	1
oL-42	16942	422Eh	Gr.2 IPv4 IP address (3)	R/W	0 ~ 255	1
oL-43	16943	422Fh	Gr.2 IPv4 IP address (4)	R/W	0 ~ 255	1
oL-44	16944	4230h	Gr.2 IPv4 subnet mask (1)	R/W	0 ~ 255	1
oL-45	16945	4231h	Gr.2 IPv4 subnet mask (2)	R/W	0 ~ 255	1
oL-46	16946	4232h	Gr.2 IPv4 subnet mask (3)	R/W	0 ~ 255	1
oL-47	16947	4233h	Gr.2 IPv4 subnet mask (4)	R/W	0 ~ 255	1
oL-48	16948	4234h	Gr.2 IPv4 default gateway (1)	R/W	0 ~ 255	1
oL-49	16949	4235h	Gr.2 IPv4 default gateway (2)	R/W	0 ~ 255	1
oL-50	16950	4236h	Gr.2 IPv4 default gateway (3)	R/W	0 ~ 255	1
oL-51	16951	4237h	Gr.2 IPv4 default gateway (4)	R/W	0 ~ 255	1
oL-60	16960	4240h	Gr.2 IPv6 IP address (1)	R/W	0 ~ 65535	1
oL-61	16961	4241h	Gr.2 IPv6 IP address (2)	R/W	0 ~ 65535	1
oL-62	16962	4242h	Gr.2 IPv6 IP address (3)	R/W	0 ~ 65535	1
oL-63	16963	4243h	Gr.2 IPv6 IP address (4)	R/W	0 ~ 65535	1
oL-64	16964	4244h	Gr.2 IPv6 IP address (5)	R/W	0 ~ 65535	1
oL-65	16965	4245h	Gr.2 IPv6 IP address (6)	R/W	0 ~ 65535	1
oL-66	16966	4246h	Gr.2 IPv6 IP address (7)	R/W	0 ~ 65535	1
oL-67	16967	4247h	Gr.2 IPv6 IP address (8)	R/W	0 ~ 65535	1
oL-68	16968	4248h	Gr.2 IPv6 subnet prefix	R/W	0 ~ 127	1
oL-69	16969	4249h	Gr.2 IPv6 default gateway (1)	R/W	0 ~ 65535	1
oL-70	16970	424Ah	Gr.2 IPv6 default gateway (2)	R/W	0 ~ 65535	1
oL-71	16971	424Bh	Gr.2 IPv6 default gateway (3)	R/W	0 ~ 65535	1
oL-72	16972	424Ch	Gr.2 IPv6 default gateway (4)	R/W	0 ~ 65535	1
oL-73	16973	424Dh	Gr.2 IPv6 default gateway (5)	R/W	0 ~ 65535	1
oL-74	16974	424Eh	Gr.2 IPv6 default gateway (6)	R/W	0 ~ 65535	1
oL-75	16975	424Fh	Gr.2 IPv6 default gateway (7)	R/W	0 ~ 65535	1
oL-76	16976	4250h	Gr.2 IPv6 default gateway (8)	R/W	0 ~ 65535	1

Function Code	Register No. (decimal)	Register No. (hexadecimal)	Function Name	R/W	Monitor Content and Setting Item	Data Resolution / Unit
PA-01	17001	4269h	Em-Force mode selection	R/W	0 ~ 1	1
PA-02	17002	426Ah	Em-Force mode frequency setting	R/W	0 ~ 59000	0.01Hz
PA-03	17003	426Bh	Rotation direction command in the Em-Force mode	R/W	0 ~ 1	1
PA-04	17004	426Ch	Commercial power supply bypass function selection	R/W	0 ~ 1	1
PA-05	17005	426Dh	Bypass function delay time	R/W	0 ~ 10000	0.1s
PA-20	17020	427Ch	Simulation mode selection	R/W	0 ~ 1	1
PA-21	17021	427Dh	Selection of error code for alarm test	R/W	0 ~ 255	1
PA-22	17022	427Eh	Output current monitor optional output selection	R/W	0 ~ 7	1
PA-23	17023	427Fh	Output current monitor optional setting value	R/W	(0 to 3.00) * CTL rated current	0.1A
PA-24	17024	4280h	P-N voltage monitor optional output selection	R/W	0 ~ 7	1
PA-25	17025	4281h	P-N voltage monitor optional setting value	R/W	200Vclass:0 ~ 4500 400Vclass:0 ~ 9000	0.1Vdc
PA-26	17026	4282h	Output voltage monitor optional output selection	R/W	0 ~ 7	1
PA-27	17027	4283h	Output voltage monitor optional setting value	R/W	200Vclass:0 ~ 3000 400Vclass:0 ~ 6000	0.1V
PA-28	17028	4284h	Output torque monitor optional output selection	R/W	0 ~ 7	1
PA-29	17029	4285h	Output torque monitor optional setting value	R/W	-5000 ~ 5000	0.1%
PA-30	17030	4286h	Frequency adjustment optional output selection	R/W	0 ~ 7	1
PA-31	17031	4287h	Frequency matching frequency optional setting value	R/W	0 ~ 59000	0.01Hz

Function Code	Register No. (decimal)	Register No. (hexadecimal)	Function Name	R/W	Monitor Content and Setting Item	Data Resolution / Unit
UA-10	18010	465Ah	Display selection	R/W	0 ~ 4	1
UA-12	18012	465Ch	Clearing of integrated input power	R/W	0 ~ 1	1
UA-13	18013	465Dh	Integrated input power display gain	R/W	1 ~ 1000	1
UA-14	18014	465Eh	Clearing of integrated output power	R/W	0 ~ 1	1
UA-15	18015	465Fh	Integrated output power display gain	R/W	1 ~ 1000	1
UA-16	18016	4660h	Soft-lock selection	R/W	0 ~ 1	1
UA-17	18017	4661h	Soft-lock target selection	R/W	0 ~ 1	1
UA-18	18018	4662h	Data R/W selection	R/W	0 ~ 1	1
UA-19	18019	4663h	Battery level warning selection	R/W	0 ~ 2	1
UA-20	18020	4664h	Operation selection at disconnection of operator keypad	R/W	0 ~ 4	1
UA-21	18021	4665h	Second setting parameter display selection	R/W	0 ~ 1	1
UA-22	18022	4666h	Option parameter display selection (when full display is selected)	R/W	0 ~ 1	1
UA-30	18030	466Eh	User parameter auto setting selection	R/W	0 ~ 1	1
UA-31	18031	466Fh	User parameter 1 selection	R/W	0 to 65535 (register No.)	1
UA-32	18032	4670h	User parameter 2 selection	R/W	0 to 65535 (register No.)	1
UA-33	18033	4671h	User parameter 3 selection	R/W	0 to 65535 (register No.)	1
UA-34	18034	4672h	User parameter 4 selection	R/W	0 to 65535 (register No.)	1
UA-35	18035	4673h	User parameter 5 selection	R/W	0 to 65535 (register No.)	1
UA-36	18036	4674h	User parameter 6 selection	R/W	0 to 65535 (register No.)	1
UA-37	18037	4675h	User parameter 7 selection	R/W	0 to 65535 (register No.)	1
UA-38	18038	4676h	User parameter 8 selection	R/W	0 to 65535 (register No.)	1
UA-39	18039	4677h	User parameter 9 selection	R/W	0 to 65535 (register No.)	1
UA-40	18040	4678h	User parameter 10 selection	R/W	0 to 65535 (register No.)	1
UA-41	18041	4679h	User parameter 11 selection	R/W	0 to 65535 (register No.)	1
UA-42	18042	467Ah	User parameter 12 selection	R/W	0 to 65535 (register No.)	1
UA-43	18043	467Bh	User parameter 13 selection	R/W	0 to 65535 (register No.)	1
UA-44	18044	467Ch	User parameter 14 selection	R/W	0 to 65535 (register No.)	1
UA-45	18045	467Dh	User parameter 15 selection	R/W	0 to 65535 (register No.)	1
UA-46	18046	467Eh	User parameter 16 selection	R/W	0 to 65535 (register No.)	1
UA-47	18047	467Fh	User parameter 17 selection	R/W	0 to 65535 (register No.)	1
UA-48	18048	4680h	User parameter 18 selection	R/W	0 to 65535 (register No.)	1
UA-49	18049	4681h	User parameter 19 selection	R/W	0 to 65535 (register No.)	1
UA-50	18050	4682h	User parameter 20 selection	R/W	0 to 65535 (register No.)	1
UA-51	18051	4683h	User parameter 21 selection	R/W	0 to 65535 (register No.)	1
UA-52	18052	4684h	User parameter 22 selection	R/W	0 to 65535 (register No.)	1
UA-53	18053	4685h	User parameter 23 selection	R/W	0 to 65535 (register No.)	1
UA-54	18054	4686h	User parameter 24 selection	R/W	0 to 65535 (register No.)	1
UA-55	18055	4687h	User parameter 25 selection	R/W	0 to 65535 (register No.)	1
UA-56	18056	4688h	User parameter 26 selection	R/W	0 to 65535 (register No.)	1
UA-57	18057	4689h	User parameter 27 selection	R/W	0 to 65535 (register No.)	1
UA-58	18058	468Ah	User parameter 28 selection	R/W	0 to 65535 (register No.)	1
UA-59	18059	468Bh	User parameter 29 selection	R/W	0 to 65535 (register No.)	1
UA-60	18060	468Ch	User parameter 30 selection	R/W	0 to 65535 (register No.)	1
UA-61	18061	468Dh	User parameter 31 selection	R/W	0 to 65535 (register No.)	1
UA-62	18062	468Eh	User parameter 32 selection	R/W	0 to 65535 (register No.)	1

Function Code	Register No. (decimal)	Register No. (hexadecimal)	Function Name	R/W	Monitor Content and Setting Item	Data Resolution / Unit
UA-90	18090	46AAh	Operator keypad display off standby time (QOP)	R/W	0 ~ 60	1min
UA-91	18091	46ABh	Initial screen selection (QOP)	R/W	0 to 65535 (register No. of d, F codes)	1
UA-92	18092	46ACh	Initial screen automatic transition function (QOP)	R/W	0 ~ 1	1
UA-93	18093	46ADh	Selection of data change during monitoring (QOP)	R/W	0 ~ 1	1
UA-94	18094	46AEh	Selection of multi-speed command change during monitoring (QOP)	R/W	0 ~ 1	1
Ub-01	18101	46B5h	Selection of initialization	R/W	0 ~ 8	1
Ub-02	18102	46B6h	Selection of initial values	R/W	0 ~ 3	1
Ub-03	18103	46B7h	Load type selection	R/W	0 ~ 2	1
Ub-05	18105	46B9h	Initialization start selection	R/W	0 ~ 1	1
UC-01	18201	4719h	Debug mode selection	R/W	0 ~ 3	1
Ud-01	18301	477Dh	Trace function selection	R/W	0 ~ 1	1
Ud-02	18302	477Eh	Trace start	R/W	0 ~ 1	1
Ud-03	18303	477Fh	Selection of the number of trace data	R/W	0 ~ 8	1
Ud-04	18304	4780h	Trace signal number selection	R/W	0 ~ 8	1
Ud-10	18310	4786h	Trace data -0 selection	R/W	0 to 65535 (register No. of d, F codes)	1
Ud-11	18311	4787h	Trace data -1 selection	R/W	0 to 65535 (register No. of d, F codes)	1
Ud-12	18312	4788h	Trace data -2 selection	R/W	0 to 65535 (register No. of d, F codes)	1
Ud-13	18313	4789h	Trace data -3 selection	R/W	0 to 65535 (register No. of d, F codes)	1
Ud-14	18314	478Ah	Trace data -4 selection	R/W	0 to 65535 (register No. of d, F codes)	1
Ud-15	18315	478Bh	Trace data -5 selection	R/W	0 to 65535 (register No. of d, F codes)	1
Ud-16	18316	478Ch	Trace data -6 selection	R/W	0 to 65535 (register No. of d, F codes)	1
Ud-17	18317	478Dh	Trace data -7 selection	R/W	0 to 65535 (register No. of d, F codes)	1
Ud-20	18320	4790h	Trace signal -0 I/O selection	R/W	0 ~ 1	1
Ud-21	18321	4791h	Trace signal -0 input terminal selection	R/W	0 ~ 110	1
Ud-22	18322	4792h	Trace signal -0 output terminal selection	R/W	0 ~ 93	1
Ud-23	18323	4793h	Trace signal -1 I/O selection	R/W	0 ~ 1	1
Ud-24	18324	4794h	Trace signal -1 input terminal selection	R/W	0 ~ 110	1
Ud-25	18325	4795h	Trace signal -1 output terminal selection	R/W	0 ~ 93	1
Ud-26	18326	4796h	Trace signal -2 I/O selection	R/W	0 ~ 1	1
Ud-27	18327	4797h	Trace signal -2 input terminal selection	R/W	0 ~ 110	1
Ud-28	18328	4798h	Trace signal -2 output terminal selection	R/W	0 ~ 93	1
Ud-29	18329	4799h	Trace signal -3 I/O selection	R/W	0 ~ 1	1
Ud-30	18330	479Ah	Trace signal -3 input terminal selection	R/W	0 ~ 110	1
Ud-31	18331	479Bh	Trace signal -3 output terminal selection	R/W	0 ~ 93	1
Ud-32	18332	479Ch	Trace signal -4 I/O selection	R/W	0 ~ 1	1
Ud-33	18333	479Dh	Trace signal -4 input terminal selection	R/W	0 ~ 110	1
Ud-34	18334	479Eh	Trace signal -4 output terminal selection	R/W	0 ~ 93	1
Ud-35	18335	479Fh	Trace signal -5 I/O selection	R/W	0 ~ 1	1
Ud-36	18336	47A0h	Trace signal -5 input terminal selection	R/W	0 ~ 110	1
Ud-37	18337	47A1h	Trace signal -5 output terminal selection	R/W	0 ~ 93	1



Function Code	Register No. (decimal)	Register No. (hexadecimal)	Function Name	R/W	Monitor Content and Setting Item	Data Resolution / Unit
<b>Ud-38</b>	18338	47A2h	Trace signal -6 I/O selection	R/W	0 ~ 1	1
<b>Ud-39</b>	18339	47A3h	Trace signal -6 input terminal selection	R/W	0 ~ 110	1
<b>Ud-40</b>	18340	47A4h	Trace signal -6 output terminal selection	R/W	0 ~ 93	1
<b>Ud-41</b>	18341	47A5h	Trace signal -7 I/O selection	R/W	0 ~ 1	1
<b>Ud-42</b>	18342	47A6h	Trace signal -7 input terminal selection	R/W	0 ~ 110	1
<b>Ud-43</b>	18343	47A7h	Trace signal -7 output terminal selection	R/W	0 ~ 93	1
<b>Ud-50</b>	18350	47AEh	Trace trigger 1 selection	R/W	0 ~ 16	1
<b>Ud-51</b>	18351	47AFh	Selection of trigger 1 operation at trace data trigger	R/W	0 ~ 1	1
<b>Ud-52</b>	18352	47B0h	Trigger 1 level at trace data trigger	R/W	0 ~ 100	1%
<b>Ud-53</b>	18353	47B1h	Selection of trigger 1 operation at trace signal trigger	R/W	0 ~ 1	1
<b>Ud-54</b>	18354	47B2h	Trace trigger 2 selection	R/W	0 ~ 16	1
<b>Ud-55</b>	18355	47B3h	Selection of trigger 2 operation at trace data trigger	R/W	0 ~ 1	1
<b>Ud-56</b>	18356	47B4h	Trigger 2 level at trace data trigger	R/W	0 ~ 100	1%
<b>Ud-57</b>	18357	47B5h	Selection of trigger 2 operation at trace signal trigger	R/W	0 ~ 1	1
<b>Ud-58</b>	18358	47B6h	Trigger condition selection	R/W	0 ~ 3	1
<b>Ud-59</b>	18359	47B7h	Trigger point setting	R/W	0 ~ 100	1%
<b>Ud-60</b>	18360	47B8h	Sampling time setting	R/W	1 ~ 10	1
<b>UE-01</b>	18401	47E1h	EzSQ execution interval	R/W	0 ~ 1	1
UE-02	18402	47E2h	EzSQ function selection	R/W	0 ~ 2	1
UE-10	18410	47EAh	EzSQ user parameter U (00)	R/W	0 ~ 65535	1
UE-11	18411	47EBh	EzSQ user parameter U (01)	R/W	0 ~ 65535	1
UE-12	18412	47ECh	EzSQ user parameter U (02)	R/W	0 ~ 65535	1
UE-13	18413	47EDh	EzSQ user parameter U (03)	R/W	0 ~ 65535	1
UE-14	18414	47EEh	EzSQ user parameter U (04)	R/W	0 ~ 65535	1
UE-15	18415	47EFh	EzSQ user parameter U (05)	R/W	0 ~ 65535	1
UE-16	18416	47F0h	EzSQ user parameter U (06)	R/W	0 ~ 65535	1
UE-17	18417	47F1h	EzSQ user parameter U (07)	R/W	0 ~ 65535	1
UE-18	18418	47F2h	EzSQ user parameter U (08)	R/W	0 ~ 65535	1
UE-19	18419	47F3h	EzSQ user parameter U (09)	R/W	0 ~ 65535	1
UE-20	18420	47F4h	EzSQ user parameter U (10)	R/W	0 ~ 65535	1
UE-21	18421	47F5h	EzSQ user parameter U (11)	R/W	0 ~ 65535	1
UE-22	18422	47F6h	EzSQ user parameter U (12)	R/W	0 ~ 65535	1
UE-23	18423	47F7h	EzSQ user parameter U (13)	R/W	0 ~ 65535	1
UE-24	18424	47F8h	EzSQ user parameter U (14)	R/W	0 ~ 65535	1
UE-25	18425	47F9h	EzSQ user parameter U (15)	R/W	0 ~ 65535	1
UE-26	18426	47FAh	EzSQ user parameter U (16)	R/W	0 ~ 65535	1
UE-27	18427	47FBh	EzSQ user parameter U (17)	R/W	0 ~ 65535	1
UE-28	18428	47FCh	EzSQ user parameter U (18)	R/W	0 ~ 65535	1
UE-29	18429	47FDh	EzSQ user parameter U (19)	R/W	0 ~ 65535	1
UE-30	18430	47FEh	EzSQ user parameter U (20)	R/W	0 ~ 65535	1
UE-31	18431	47FFh	EzSQ user parameter U (21)	R/W	0 ~ 65535	1
UE-32	18432	4800h	EzSQ user parameter U (22)	R/W	0 ~ 65535	1
UE-33	18433	4801h	EzSQ user parameter U (23)	R/W	0 ~ 65535	1
UE-34	18434	4802h	EzSQ user parameter U (24)	R/W	0 ~ 65535	1
UE-35	18435	4803h	EzSQ user parameter U (25)	R/W	0 ~ 65535	1

Function Code	Register No. (decimal)	Register No. (hexadecimal)	Function Name	R/W	Monitor Content and Setting Item	Data Resolution / Unit
UE-36	18436	4804h	EzSQ user parameter U (26)	R/W	0 ~ 65535	1
UE-37	18437	4805h	EzSQ user parameter U (27)	R/W	0 ~ 65535	1
UE-38	18438	4806h	EzSQ user parameter U (28)	R/W	0 ~ 65535	1
UE-39	18439	4807h	EzSQ user parameter U (29)	R/W	0 ~ 65535	1
UE-40	18440	4808h	EzSQ user parameter U (30)	R/W	0 ~ 65535	1
UE-41	18441	4809h	EzSQ user parameter U (31)	R/W	0 ~ 65535	1
UE-42	18442	480Ah	EzSQ user parameter U (32)	R/W	0 ~ 65535	1
UE-43	18443	480Bh	EzSQ user parameter U (33)	R/W	0 ~ 65535	1
UE-44	18444	480Ch	EzSQ user parameter U (34)	R/W	0 ~ 65535	1
UE-45	18445	480Dh	EzSQ user parameter U (35)	R/W	0 ~ 65535	1
UE-46	18446	480Eh	EzSQ user parameter U (36)	R/W	0 ~ 65535	1
UE-47	18447	480Fh	EzSQ user parameter U (37)	R/W	0 ~ 65535	1
UE-48	18448	4810h	EzSQ user parameter U (38)	R/W	0 ~ 65535	1
UE-49	18449	4811h	EzSQ user parameter U (39)	R/W	0 ~ 65535	1
UE-50	18450	4812h	EzSQ user parameter U (40)	R/W	0 ~ 65535	1
UE-51	18451	4813h	EzSQ user parameter U (41)	R/W	0 ~ 65535	1
UE-52	18452	4814h	EzSQ user parameter U (42)	R/W	0 ~ 65535	1
UE-53	18453	4815h	EzSQ user parameter U (43)	R/W	0 ~ 65535	1
UE-54	18454	4816h	EzSQ user parameter U (44)	R/W	0 ~ 65535	1
UE-55	18455	4817h	EzSQ user parameter U (45)	R/W	0 ~ 65535	1
UE-56	18456	4818h	EzSQ user parameter U (46)	R/W	0 ~ 65535	1
UE-57	18457	4819h	EzSQ user parameter U (47)	R/W	0 ~ 65535	1
UE-58	18458	481Ah	EzSQ user parameter U (48)	R/W	0 ~ 65535	1
UE-59	18459	481Bh	EzSQ user parameter U (49)	R/W	0 ~ 65535	1
UE-60	18460	481Ch	EzSQ user parameter U (50)	R/W	0 ~ 65535	1
UE-61	18461	481Dh	EzSQ user parameter U (51)	R/W	0 ~ 65535	1
UE-62	18462	481Eh	EzSQ user parameter U (52)	R/W	0 ~ 65535	1
UE-63	18463	481Fh	EzSQ user parameter U (53)	R/W	0 ~ 65535	1
UE-64	18464	4820h	EzSQ user parameter U (54)	R/W	0 ~ 65535	1
UE-65	18465	4821h	EzSQ user parameter U (55)	R/W	0 ~ 65535	1
UE-66	18466	4822h	EzSQ user parameter U (56)	R/W	0 ~ 65535	1
UE-67	18467	4823h	EzSQ user parameter U (57)	R/W	0 ~ 65535	1
UE-68	18468	4824h	EzSQ user parameter U (58)	R/W	0 ~ 65535	1
UE-69	18469	4825h	EzSQ user parameter U (59)	R/W	0 ~ 65535	1
UE-70	18470	4826h	EzSQ user parameter U (60)	R/W	0 ~ 65535	1
UE-71	18471	4827h	EzSQ user parameter U (61)	R/W	0 ~ 65535	1
UE-72	18472	4828h	EzSQ user parameter U (62)	R/W	0 ~ 65535	1
UE-73	18473	4829h	EzSQ user parameter U (63)	R/W	0 ~ 65535	1

Function Code	Register No. (decimal)	Register No. (hexadecimal)	Function Name	R/W	Monitor Content and Setting Item	Data Resolution / Unit
UF-02	18502	4846h	EzSQ user parameter UL (00) (High)	R/W	-2147483647 ~ 2147483647	1
(UF-03)	18503	4847h	(Low)			
UF-04	18504	4848h	EzSQ user parameter UL (01) (High)	R/W	-2147483647 ~ 2147483647	1
(UF-05)	18505	4849h	(Low)			
UF-06	18506	484Ah	EzSQ user parameter UL (02) (High)	R/W	-2147483647 ~ 2147483647	1
(UF-07)	18507	484Bh	(Low)			
UF-08	18508	484Ch	EzSQ user parameter UL (03) (High)	R/W	-2147483647 ~ 2147483647	1
(UF-09)	18509	484Dh	(Low)			
UF-10	18510	484Eh	EzSQ user parameter UL (04) (High)	R/W	-2147483647 ~ 2147483647	1
(UF-11)	18511	484Fh	(Low)			
UF-12	18512	4850h	EzSQ user parameter UL (05) (High)	R/W	-2147483647 ~ 2147483647	1
(UF-13)	18513	4851h	(Low)			
UF-14	18514	4852h	EzSQ user parameter UL (06) (High)	R/W	-2147483647 ~ 2147483647	1
(UF-15)	18515	4853h	(Low)			
UF-16	18516	4854h	EzSQ user parameter UL (07) (High)	R/W	-2147483647 ~ 2147483647	1
(UF-17)	18517	4855h	(Low)			
UF-18	18518	4856h	EzSQ user parameter UL (08) (High)	R/W	-2147483647 ~ 2147483647	1
(UF-19)	18519	4857h	(Low)			
UF-20	18520	4858h	EzSQ user parameter UL (09) (High)	R/W	-2147483647 ~ 2147483647	1
(UF-21)	18521	4859h	(Low)			
UF-22	18522	485Ah	EzSQ user parameter UL (10) (High)	R/W	-2147483647 ~ 2147483647	1
(UF-23)	18523	485Bh	(Low)			
UF-24	18524	485Ch	EzSQ user parameter UL (11) (High)	R/W	-2147483647 ~ 2147483647	1
(UF-25)	18525	485Dh	(Low)			
UF-26	18526	485Eh	EzSQ user parameter UL (12) (High)	R/W	-2147483647 ~ 2147483647	1
(UF-27)	18527	485Fh	(Low)			
UF-28	18528	4860h	EzSQ user parameter UL (13) (High)	R/W	-2147483647 ~ 2147483647	1
(UF-29)	18529	4861h	(Low)			
UF-30	18530	4862h	EzSQ user parameter UL (14) (High)	R/W	-2147483647 ~ 2147483647	1
(UF-31)	18531	4863h	(Low)			
UF-32	18532	4864h	EzSQ user parameter UL (15) (High)	R/W	-2147483647 ~ 2147483647	1
(UF-33)	18533	4865h	(Low)			

# 15

## Chapter 15 Optional Cassettes

Contents

15.1 What This Chapter Explains ..... 15-1

15.2 Installation of Optional Cassettes ..... 15-1

15.3 Parameters Related to Optional Devices .... 15-2

    15.3.1 Settings common to optional cassettes 15-2

15.4 Feedback Option Overview ..... 15-5

    15.4.1 Options for line driver ..... 15-5

15.5 Communication Option Overview ..... 15-6

    15.5.1 Ethernet (Modbus-TCP) option ..... 15-7

    15.5.2 EtherCAT option ..... 15-7

15.6 Terminal Extension Option Overview ..... 15-8

    15.6.1 Analog extension options ..... 15-8

15.7 Functional Safety Expansion Option Overview ..... 15-9

    15.7.1 Functional safety expansion options ..... 15-9

### 15.1 What This Chapter Explains

- This chapter describes optional boards that are able to connect to PI.
- For details, refer to the instruction manual provided together with respective optional devices.

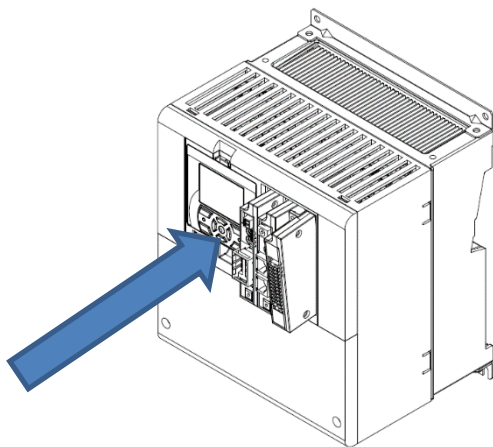

### 15.2 Installation of Optional Cassettes

- When inserting an optional cassette, remove the slot cover screws and straightly insert an optional cassette you want to use. Then set the optional cassette to be secured with the removed screws.
- Connection state of optional cassettes can be monitored on the option slot mounted state monitors [dA-81] (SLOT1) to [dA-83] (SLOT3).

Connection Part	Name	Description
SLOT1	Optional cassette slot 1	For connecting various optional cassettes.
SLOT2	Optional cassette slot 2	For connecting various optional cassettes. The encoder feedback option (P1-FB) must be connected to the slot 2.
SLOT3	Optional cassette slot 3	For connecting various optional cassettes.

## 15.3 Parameters Related to Optional Devices

### 15.3.1 Common settings of optional cassettes

■ Operation selection when option error occurs (operation when communication error occurs between P1 main unit and optional cassette)



- Want to continue operation of the converter even when a communication error is detected between the P1 main unit and an optional cassette.



- You can set up operations to be executed when a factor for option errors (E060, E069/E070, E079/E080, E089) occurs, per slot ([oA-10]/[oA-20]/[oA-30]).
- For operation errors, refer to the instruction manual provided together with each optional cassette.



- When “continues operating (01)” is selected for “operation setting when option error occurs ([oA-10]/[oA-20]/[oA-30])”, even when an operation stop command is given via an optional cassette, an operation may not be stopped via the optional cassette. Make sure to design a system configuration so that an operation can be stopped via option cassettes.
- Option errors except for E060, E069/E070, E079/E080, and E089, as well as errors exclusive to optional cassettes (E090 to E109) are disabled in this inverter.  
(An error occurs and the inverter stops operating.)

#### ■ Parameter

Item	Parameter	Data	Description
Operation selection when option error occurs (slot 1)	[oA-10]	00	Stops after an error occurs.
		01	Continues operating.
Operation selection when option error occurs (slot 2)	[oA-20]	00	Stops after an error occurs.
		01	Continues operating.
Operation selection when option error occurs (slot 3)	[oA-30]	00	Stops after an error occurs.
		01	Continues operating.

■ Operation setting for communication error

- This function is for optional cassettes P1-PB and P1-PN. The function is disabled when other optional cassettes are used.
- For details, refer to the guides for optional cassettes P1-PB and P1-PN.

■ Parameter

Item	Parameter	Data	Description
Communication monitoring timer setting (slot 1)	[oA-11]	0.00~100.00 (s)	Communication error monitoring time
Operation setting for communication error (slot 1)	[oA-12]	00	An error occurs.
		01	An error occurs after a deceleration stop.
		02	Ignore
		03	Free-run stop
		04	Deceleration stop
Communication monitoring timer setting (slot 2)	[oA-21]	0.00~100.00 (s)	Communication error monitoring time
Operation setting for communication error (slot 2)	[oA-22]	00	An error occurs.
		01	An error occurs after a deceleration stop.
		02	Ignore
		03	Free-run stop
		04	Deceleration stop
Communication monitoring timer setting (slot 3)	[oA-31]	0.00~100.00 (s)	Communication error monitoring time
Operation setting for communication error (slot 3)	[oA-32]	00	An error occurs.
		01	An error occurs after a deceleration stop.
		02	Ignore
		03	Free-run stop
		04	Deceleration stop

### ■ Operation command behavior at start of option

**Q**

- Output operation start-up is slow when a communication option is connected.

**A**

- When a communication option is used, if “00” is selected for “operation command behavior at start of option”, an operation command is accepted after connection with the communication option is confirmed.
- If “01” is set for “selection of operation command behavior at start of option”, an operation command is accepted without waiting for confirmation of connection with the communication option. When a communication option is used only for monitoring power and an operation command is given using input terminal function or the like, an output operation may start faster by setting “01” for the said selection.

### ■ Parameter

Item	Parameter	Data	Description
Selection of operation command behavior at start of option (slot 1)	[oA-13]	00	Operation command disabled
		01	Operation command enabled
Selection of operation command behavior at start of option (slot 2)	[oA-23]	00	Operation command disabled
		01	Operation command enabled
Selection of operation command behavior at start of option (slot 3)	[oA-33]	00	Operation command disabled
		01	Operation command enabled

## 15.4 Feedback Option Overview

### 15.4.1 Options for line driver

- Option P1-FB for line driver is an interface option to inverters which is corresponding to 5V line driver output for incremental type rotary encoder.
- Combining this option with an inverter to detect and feedback rotation speed of the motor with encoder suppresses speed fluctuation and realizes high precision operation.
- In addition, by inputting pulse string position command, you can execute position control, synchronous operation, orientation function, etc. For details, refer to the following sections contained herein and P1-FB user's guide.

■ On settings of encoder  
"12.9.17 Use encoder"

■ On control mode  
"12.9.1 Selection of control mode"

■ On settings of pulse train input  
"12.4.6 Make pulse train input command."

■ On position control  
"12.17.7 Conduct pulse train position control"  
12.17.8 Stopping at Designated Position  
"12.17.9 Control in the origin-based absolute position"

■ Related parameters  
Refer to the aforementioned sections contained herein and P1-FB user's guide.



## 15.5 Communication Option Overview



- When using a communication option, do not change “CF-11 resistor data selection” from “00:(A, V).”
- Do not change the settings of following parameters:

Parameter
[oC-01]~[oC-28]
[oE-01]~[oE-70]
[oH-20]~[oH-34]
[oJ-01]~[oJ-60]

### ■ Related parameters (common to communication options)

Item	Parameter
Gr.1 IPv4 IP address (1)	[oL-01]
Gr.1 IPv4 IP address (2)	[oL-02]
Gr.1 IPv4 IP address (3)	[oL-03]
Gr.1 IPv4 IP address (4)	[oL-04]
Gr.1 IPv4 subnet mask (1)	[oL-05]
Gr.1 IPv4 subnet mask (2)	[oL-06]
Gr.1 IPv4 subnet mask (3)	[oL-07]
Gr.1 IPv4 subnet mask (4)	[oL-08]
Gr.1 IPv4 default gateway (1)	[oL-09]
Gr.1 IPv4 default gateway (2)	[oL-10]
Gr.1 IPv4 default gateway (3)	[oL-11]
Gr.1 IPv4 default gateway (4)	[oL-12]
Gr.1 IPv6 IP address (1)	[oL-20]
Gr.1 IPv6 IP address (2)	[oL-21]
Gr.1 IPv6 IP address (3)	[oL-22]
Gr.1 IPv6 IP address (4)	[oL-23]
Gr.1 IPv6 IP address (5)	[oL-24]
Gr.1 IPv6 IP address (6)	[oL-25]
Gr.1 IPv6 IP address (7)	[oL-26]
Gr.1 IPv6 IP address (8)	[oL-27]
Gr.1 IPv6 subnet prefix	[oL-28]
Gr.1 IPv6 default gateway (1)	[oL-29]
Gr.1 IPv6 default gateway (2)	[oL-30]
Gr.1 IPv6 default gateway (3)	[oL-31]
Gr.1 IPv6 default gateway (4)	[oL-32]
Gr.1 IPv6 default gateway (5)	[oL-33]
Gr.1 IPv6 default gateway (6)	[oL-34]
Gr.1 IPv6 default gateway (7)	[oL-35]
Gr.1 IPv6 default gateway (8)	[oL-36]

### ■ Related parameters (common to communication options)

Item	Parameter
Gr.2 IPv4 IP address (1)	[oL-40]
Gr.2 IPv4 IP address (2)	[oL-41]
Gr.2 IPv4 IP address (3)	[oL-42]
Gr.2 IPv4 IP address (4)	[oL-43]
Gr.2 IPv4 subnet mask (1)	[oL-44]
Gr.2 IPv4 subnet mask (2)	[oL-45]
Gr.2 IPv4 subnet mask (3)	[oL-46]
Gr.2 IPv4 subnet mask (4)	[oL-47]
Gr.2 IPv4 default gateway (1)	[oL-48]
Gr.2 IPv4 default gateway (2)	[oL-49]
Gr.2 IPv4 default gateway (3)	[oL-50]
Gr.2 IPv4 default gateway (4)	[oL-51]
Gr.2 IPv6 IP address (1)	[oL-60]
Gr.2 IPv6 IP address (2)	[oL-61]
Gr.2 IPv6 IP address (3)	[oL-62]
Gr.2 IPv6 IP address (4)	[oL-63]
Gr.2 IPv6 IP address (5)	[oL-64]
Gr.2 IPv6 IP address (6)	[oL-65]
Gr.2 IPv6 IP address (7)	[oL-66]
Gr.2 IPv6 IP address (8)	[oL-67]
Gr.2 IPv6 subnet prefix	[oL-68]
Gr.2 IPv6 default gateway (1)	[oL-69]
Gr.2 IPv6 default gateway (2)	[oL-70]
Gr.2 IPv6 default gateway (3)	[oL-71]
Gr.2 IPv6 default gateway (4)	[oL-72]
Gr.2 IPv6 default gateway (5)	[oL-73]
Gr.2 IPv6 default gateway (6)	[oL-74]
Gr.2 IPv6 default gateway (7)	[oL-75]
Gr.2 IPv6 default gateway (8)	[oL-76]

### 15.5.1 Ethernet (Modbus-TCP) option

- Ethernet communication is performed with Modbus-TCP protocol. For details, refer to the guide for optional cassette P1-EN.

#### ■ Related parameters (Ethernet options)

Item	Parameter
IP address selection (P1-EN)	[oH-01]
Transmission speed (port 1) (P1-EN)	[oH-02]
Transmission speed (port 2) (P1-EN)	[oH-03]
Ethernet communication timeout (P1-EN)	[oH-04]
Modbus TCP port number (IPv4)	[oH-05]
Modbus TCP port number (IPv6)	[oH-06]

### 15.5.2 EtherCAT option

- Use this option to perform EtherCAT communication. For details, refer to the instruction manual provided together with option P1-ECT.

#### ■ Related parameters

- None

## 15.6 Terminal Extension Option

### Overview

#### 15.6.1 Analog extension options

- This is an option for extending analog inputs and outputs (voltage/current) on the control circuit terminal block. For details, refer to the guide for optional cassette P1-AG.

#### ■ Related parameters (AG options)

Item	Parameter
[Ai4] terminal input filter time constant	[oE-01]
[Ai4] terminal start amount	[oE-03]
[Ai4] terminal end amount	[oE-04]
[Ai4] terminal start ratio	[oE-05]
[Ai4] terminal end ratio	[oE-06]
[Ai4] terminal start selection	[oE-07]
[Ai5] terminal input filter time constant	[oE-11]
[Ai5] terminal start amount	[oE-13]
[Ai5] terminal end amount	[oE-14]
[Ai5] terminal start ratio	[oE-15]
[Ai5] terminal end ratio	[oE-16]
[Ai5] terminal start selection	[oE-17]
[Ai6] terminal input filter time constant	[oE-21]
[Ai6] terminal start amount	[oE-23]
[Ai6] terminal end amount	[oE-24]
[Ai6] terminal start ratio	[oE-25]
[Ai6] terminal end ratio	[oE-26]
[Ai4] voltage/current bias adjustment	[oE-28]
[Ai4] voltage adjustment gain	[oE-29]
[Ai5] voltage/current bias adjustment	[oE-30]
[Ai5] voltage adjustment gain	[oE-31]
[Ai6] voltage bias adjustment	[oE-32]
[Ai6] voltage adjustment gain	[oE-33]
Window comparator [Ai4] upper limit level	[oE-35]
Window comparator [Ai4] lower limit level	[oE-36]
Window comparator [Ai4] hysteresis range	[oE-37]
Window comparator [Ai5] upper limit level	[oE-38]
Window comparator [Ai5] lower limit level	[oE-39]
Window comparator [Ai5] hysteresis range	[oE-40]
Window comparator [Ai6] lower limit level	[oE-41]
Window comparator [Ai6] lower limit level	[oE-42]
Window comparator [Ai6] hysteresis range	[oE-43]

Item	Parameter
[Ai4] operation level at disconnection	[oE-44]
[Ai4] operation level selection at disconnection	[oE-45]
[Ai5] operation level at disconnection	[oE-46]
[Ai5] operation level selection at disconnection	[oE-47]
[Ai6] operation level at disconnection	[oE-48]
[Ai6] operation level selection at disconnection	[oE-49]
[Ao3] terminal output selection	[oE-50]
[Ao4] terminal output selection	[oE-51]
[Ao5] terminal output selection	[oE-52]
[Ao3] output filter time constant	[oE-56]
[Ao3] output data type selection	[oE-57]
[Ao3] bias adjustment (voltage/current)	[oE-58]
[Ao3] gain adjustment (voltage/current)	[oE-59]
[Ao3] output level in the adjustment mode	[oE-60]
[Ao4] output filter time constant	[oE-61]
[Ao4] output data type selection	[oE-62]
[Ao4] bias adjustment (voltage/current)	[oE-63]
[Ao4] gain adjustment (voltage/current)	[oE-64]
[Ao4] output level in the adjustment mode	[oE-65]
[Ao5] output filter time constant	[oE-66]
[Ao5] output data type selection	[oE-67]
[Ao5] bias adjustment (voltage)	[oE-68]
[Ao5] gain adjustment (voltage)	[oE-69]
[Ao5] output level in the adjustment mode	[oE-70]

#### ■ Related monitors

Item	Parameter
Analog I/O selection monitor	[dA-60]
Extended analog input [Ai4] monitor	[dA-64]
Extended analog input [Ai5] monitor	[dA-65]
Extended analog input [Ai6] monitor	[dA-66]

## 15.7 Functional Safety Expansion

### Option Overview

#### 15.7.1 Functional safety expansion options

- This is an option for expanding safety functions.  
For details, refer to the guide for P1-FS option safety function.

##### ■ Related parameters (FS options)

Item	Parameter
Safety-option input indication selection	[oC-01]
SS1-A deceleration time	[oC-10]
SLS-A deceleration time	[oC-12]
SLS-A speed upper limit: normal rotation	[oC-14]
SLS-A speed upper limit: reverse rotation	[oC-15]
SDI-A deceleration time	[oC-16]
SDI-A restriction direction	[oC-18]
SS1-B deceleration time	[oC-20]
SLS-B deceleration time	[oC-22]
SLS-B speed upper limit: normal rotation	[oC-24]
SLS-B speed upper limit: reverse rotation	[oC-25]
SDI-B deceleration time	[oC-26]
SDI-B restriction direction	[oC-28]

##### ■ Related monitors

Item	Parameter
P1-FS hardware monitor	[dA-46]
P1-FS function monitor	[dA-47]

(Memo)

## 16

## Chapter 16 ProDriveNext / EzSQ





## Contents

16.1 What This Chapter Explains .....	16-1
16.2 “ProDriveNext” .....	16-2
16.2.1 Connecting PC and inverter .....	16-2
16.2.2 What you can do with “ProDriveNext” ...	16-2
16.3 Program Operation Function EzSQ .....	16-3
16.3.1 EzSQ specification .....	16-3
16.3.2 EzSQ use procedure .....	16-4
16.3.3 EzSQ function related parameters .....	16-5
16.4 Trace Functions .....	16-7
16.4.1 Trace function specification .....	16-7
16.4.2 Trace function use procedure .....	16-7
16.4.3 Trace function related parameters .....	16-8

16.1 What This Chapter Explains

This chapter provides the inverter side details related to PC software “ProDriveNext”.

For more details, see the instruction manuals of “ProDriveNext” and program operation function EzSQ.

Symbol	Meanings
	General and troubleshooting questions
	Key points for a solution
	Notes
	Confirmation of procedures

## 16.2 “ProDriveNext”

**Q**

- Want to manage parameters by PC.
- Want to perform an automatic operation using the program operation function.
- Want to check the monitor data graphically at the time of error.

### 16.2.1 Connecting PC and inverter

- Install Hitachi’s “ProDriveNext” to your PC.
- Connect the inverter and the PC using a USB cable.

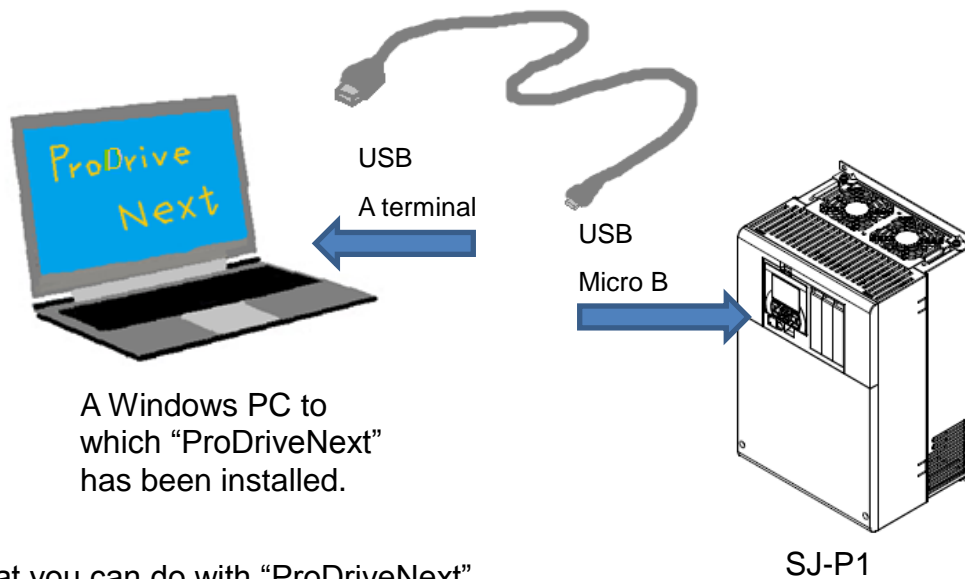

### 16.2.2 What you can do with “ProDriveNext”

**A**

#### ■ Parameter setting function

- You can configure various parameter settings such as setting parameters individually and searching parameters changed from the factory setting.
- Parameters can be stored and read as CSV file format.

#### ■ Monitor function

- You can set arbitrary parameters and conduct monitoring accordingly.
- Monitor data can be stored and read out in the CSV file format.

#### ■ Trace function

- This function enables you to set parameters and triggers in order to show data graphically at occurrence of a trigger.
- Traced data can be stored and read as CSV file format.

**A**

- With the PC tool “ProDriveNext”, the following functions are usable: wizard function for supporting an operation setting; function for writing a parameter to and reading out a parameter from a file; function for creating a program and downloading to inverters; function for tracing an error when it occurs; etc.
- For installation procedure, see the instruction manual of “ProDriveNext”.

#### ■ Functions for program operation (EzSQ)

- You can download the program to the inverter to customize the inverter for you.
- With its BASIC-like entry-type or selection-type programming function, EzSQ enables you to freely designate input/output and operation stop of the inverter.
- Programs can be stored and read out in the CSV file format.

**!**

- For more details, see the instruction manuals of “ProDriveNext” and EzSQ.
- “ProDriveNext” must be used under the following conditions:  
 [CF-02] Communication station number selection is set to “1”;  
 [CF-11] Resister data selection is set to “00:(A,V)”;  
 and  
 [CF-50] USB station number selection is set to “1”.

## 16.3 Program Operation Function

### EzSQ

#### 16.3.1 EzSQ specification



- EzSQ is a function which realizes easy sequence operations when you create a program with “ProDriveNext” and download the program to the inverter.

#### ■ Specifications



- For more details, see the instruction manuals of “ProDriveNext” and EzSQ.

Item		Specification	
Language specification	Linguistic form	BASIC-like	
	Program inputting device	Windows PCs (For applicable OSs, see the instruction manual of “ProDriveNext”.)	
	Execution form	<ul style="list-style-type: none"> <li>Interpreter type</li> <li>Execution interval: Select either 1 ms or 2 ms per step (parameter [UE-01]).</li> <li>Subroutine call availability: Max. 8 nests</li> <li>Multitasking capability: Max. 5 tasks</li> </ul>	
	Program capacity	Up to 1,024 steps per task, hence up to 7,680 bytes in total of 5 tasks	
Input/output related function	External input	Contact signal	24V open collector input (input terminals 1 to 9, A, and B)
		Program activation	Select “Activated by PRG terminal” or “Always active”.
		General purpose input terminal	Max. 11 terminals (X (00) to X (10) <incl. A and B terminals>)
	General purpose analog input	XA (0):0 to 10V /0 to 20mA (Ai1 terminal)	
		XA (1):0 to 10V /0 to 20mA (Ai2 terminal)	
		XA (2):-10 to 10V (Ai3 terminal)	
External output	General purpose output terminal	Max. 7 terminals (Y (00) to Y (06) <incl. relay contact outputs>)	
	General purpose analog output	YA (0) to YA (2) (allocated to FM, Ao1, and Ao2 terminals.)	
Reserved word	Instruction	① Program control instruction: Loop (for) / Unconditional branches (go to) / Time control (wait) / Subroutines (call, sub) / Conditional branches (if then, ifs then, select case, until, while) / others (entry, end, cont, inc, dec)	
		② Arithmetic instruction: 4 arithmetic operations (+, -, *, /) / Remainder (mod) / Assignment (=) / Absolute value (abs) / Logical operations (or, and, xor, not)	
		③ Input/output controlling: General purpose input/output (bit input, word input, bit output, word output) / Inverter input terminal reading	
		④ Timer controlling: Delay operation / Timer control	
		⑤ Parameter controlling: Monitor/setting can be changed by designating an operator display code.	
	Number of variables	User-defined variable	U (00) to U (63) / 64 variables
		User-defined variable (LONG)	UL (00) to UL (15) / 16 variables
		Main speed command	SET-Freq
		Acceleration time	ACCEL
		Deceleration time	DECEL
		Monitor variable	FM, Iout, Dir, PID-FB, F-CNV, Tmon, Vout, Power, RUN-Time, ON-Time, PlsCnt, POS, STATUS, DCV, ERR CNT, ERR (1)~ERR (10)
		General purpose input contact	X (00) to X (10) / 11 variables
		General purpose output contact	Y (00) to Y (06) / 7 variables (2 of them are for relay contact outputs)
Internal user contact	UB (00) to UB (15) / 16 variables		
Internal timer contact	TD (0) to TD (15) / 16 variables		
Inverter input/output	Designated with operator display codes		
User monitor	Displaying arbitrary data on the inverter operator / 5 variables		
User trip	Making the inverter trip during programming / 10 variables		



### 16.3.2 EzSQ use procedure

#### ■ Flow up until execution of EzSQ

No.	Description	Remarks
1	Create an EzSQ program with "ProDriveNext".	"ProDriveNext" is required.
2	Compile the program in the form executable in the inverter. As soon as the compiling begins, the grammar of EzSQ program is checked. If there is an error, the compiling is suspended and the error message appears.	
3	Download the compiled EzSQ program to the inverter and save it to the memory element of inverter.* 1)	
4	Set necessary parameters for the inverter.	See "16.3.3 EzSQ function related parameters".
5	Set the EzSQ function selection [UE-02] to Enable (01 or 02).	
6	When UE-02 is set to 01, the PRG terminal is turned ON and the program will be executed. When UE-02 is set to 02, the program will be executed automatically after the power supply is turned ON. 2)	
7	The operation state of EzSQ can be checked on the inverter operator keypad.	



\*1) By saving the program to the memory element incorporated in the inverter (data flash), you will also be able to execute the program after the power supply is re-turned ON. If the downloaded program hasn't been saved to the memory element, the program will be erased when the inverter power supply is shut off. When you create a program and carry out debugs including operation check, it is recommended to save after the debugs are completed instead of saving to the memory element.

\*2) Once the program is downloaded to the inverter, the EzSQ program becomes executable with the inverter disconnected from the PC.



- Because SJ-P1 doesn't share the same parameter numbers, setting range, the minimum unit, etc. with conventional models like SJ700/L700, the EzSQ programs created for these conventional models may not be used as is. Make sure to carry out re-examination of the programs and operation checks.
- When a reset or trip reset using the RS terminal is performed during execution of an EzSQ program, the program counter will be reset and the program will be executed from the lead.

### 16.3.3 EzSQ function related parameters

#### ■ EzSQ function related parameters (monitors)

Item	Parameter	Data	Description
Program download monitor	[db-01]	00 (without program)	Program hasn't been downloaded.
		01 (with program)	Program has been downloaded.
Program number monitor	[db-02]	0000~9999	Program No. of downloaded program is displayed.
Program counter (Task-1)	[db-03]	0~1024	For each task (Task-1 to Task-5), the line number which is being executed is monitored.
Program counter (Task-2)	[db-04]		
Program counter (Task-3)	[db-05]		
Program counter (Task-4)	[db-06]		
Program counter (Task-5)	[db-07]		
User monitor 0	[db-08]	-2147483647 ~2147483647	The data which was output to Umon (00) to Umon (04) in the program is monitored. [db-08] ← Umon (00) [db-10] ← Umon (01) [db-12] ← Umon (02) [db-14] ← Umon (03) [db-16] ← Umon (04)
User monitor 1	[db-10]		
User monitor 2	[db-12]		
User monitor 3	[db-14]		
User monitor 4	[db-16]		
Analog output monitor YA0	[db-18]	0.00~10000	The data which was output to YA (00) to YA (05) in the program is monitored. YA0 [db-18] ← YA(00) YA1 [db-19] ← YA(01) YA2 [db-20] ← YA(02) YA3 [db-21] ← YA(03) YA4 [db-22] ← YA(04) YA5 [db-23] ← YA(05)
Analog output monitor YA1	[db-19]		
Analog output monitor YA2	[db-20]		
Analog output monitor YA3	[db-21]		
Analog output monitor YA4	[db-22]		
Analog output monitor YA5	[db-23]		

### ■ Related parameters (settings)

Item	Parameter	Data	Description
EzSQ execution interval	[UE-01]	00	1ms/Step
		01	2ms/Step
EzSQ function selection	[UE-02]	00	EzSQ function disabled
		01	EzSQ function enabled (Activated by PRG terminal)
		02	EzSQ function enabled (Always active)
EzSQ user parameters U (00) to U (63)	[UE-10]~[UE-73]	0~65535	U (00) to U (63) on the program is operable via the operator keypad.
EzSQ user parameters UL (00) to UL (15)	[UF-02]~[UF-32]	-2147483647 ~2147483647	UL (00) to UL (15) on the program is operable via the operator keypad.
Main speed command selection Auxiliary speed command selection	[AA101] [AA102]	14	To set frequency in the SET-Freq variable, select 14 (program function) for these parameters. *1)
Operation command selection	[AA111]	00	To operate and stop the inverter using the variables FW and RV respectively, select 00 (terminal [FW]/[RV]) for this operation command parameter. *1)
Acceleration or deceleration time input selection	[AC-01]	04	To set acceleration and deceleration time in the ACCEL and DECEL variables respectively, select 14 (program function) for this parameter.
Input terminal 1 to 9, A or B selection	[CA-01]~[CA-11]	099	PRG: EzSQ function PRG terminal *2)
Input terminal 1 to 9, A or B selection	[CA-01]~[CA-11]	086~096	MI1 to MI11: General purpose input 1 to 9, A or B
Output terminal 11 to 15 selection Relay output terminal selection 16 or AL	[CC-01]~[CC-07]	069~075	MO1 to MO7: General purpose output 1 to 7
Analogue input [Ai1] terminal	- (setting not required)	—	XA (0): General purpose analog input (0 to 10 V /0 to 20 mA)
Analogue input [Ai2] terminal	- (setting not required)	—	XA (1): General purpose analog input (0 to 10 V /0 to 20 mA)
Analogue input [Ai3] terminal	- (setting not required)	—	XA (2): General purpose analog input (-10 to 10 V)
FM output [FM] terminal selection	[Cd-03]	[db-18] [db-19] [db-20]	YA (0): General purpose analog output YA (1): General purpose analog output YA (2): General purpose analog output
Analogue output [Ao1] terminal selection	[Cd-04]		
Analogue output [Ao2] terminal selection	[Cd-05]		



- \*1) If you select a value other than the aforementioned value for parameters [AA101] (Main speed command) or [AA111] (Operation command), you can enter speed or operation command using the operator keypad or analog signal.
- \*2) Assign 099 [PRG] to the input terminal only if you select 01 (Activated by PRG terminal) for [UE-02] (EzSQ function selection).

### ■ EzSQ program activation timing

- (1) When [UE-02] (Activated by [PRG] terminal) is set to 01,
- Assign 099 [PRG] terminal to any of the input terminals 1 to 9, A and B. The EzSQ program will be activated when the PRG terminal is turned ON.

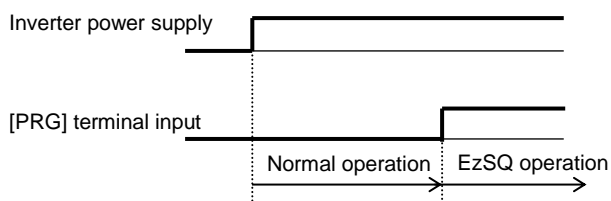

- As for variables that require adjustment on the actual inverter, you can change the data on the operator keypad without connecting the inverter to a PC if you have designated the variables to user parameters ([UE-10] to [UE-73] and/or [UF-02] to [UF-32]).

- (2) When [UE-02] (Always active) is set to 02,

- The EzSQ program is constantly active while the inverter power is ON.

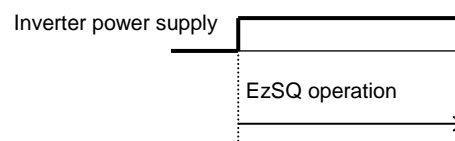

## 16.4 Trace Functions

### 16.4.1 Trace function specification



- The trace function is a function for obtaining and accumulating the inverter monitor data under the set conditions.
- With “ProDriveNext”, accumulated data (accumulated trace data) can be uploaded, shown graphically, and stored.

#### Specifications

Item	Description
Number of trace data	Monitor data: Max. 8 data Signal: Max. 8 signals (Select from the Input/output terminal function.)
Accumulated trace data size	8kbytes
Sampling time (interval)	Select from 0.2 ms, 0.5 ms, 1 ms, 2 ms, 5 ms, 10 ms, 50 ms, 100 ms, 500 ms, and 1000 ms.
Number of sampling points	It varies depending on the number of trace data, the number of signals, and data size of parameters to be traced. Ex. 953 sampling points if “the number of trace data is 4; the number of signals is 1; and the data size of them is respectively 2 bytes”.
Trace starting method	“ProDriveNext”, parameter setting, input terminal (DTR (data trace starting signal))
Trigger condition	2 conditions (4 conditions in total by the combination of them) Select either Trip or Trace data (monitor data, signal). Trigger level and trigger point can be set.
Others	<ul style="list-style-type: none"> <li>• Trace function state signals ([WFT] is ON in a trigger stand-by state, and [TRA] is ON during tracing)</li> <li>• To graphically show or store accumulated trace data, “ProDriveNext” is required.</li> </ul>



- For more details, see the instruction manual of “ProDriveNext”.

### 16.4.2 Trace function use procedure

#### Trace function use procedure

No.	Description	Remarks
1	Enable the trace function. (Set [Ud-01] to 01(Enable).)	See "16.4.3 Trace function related parameters". (These items can also be set with “ProDriveNext”.)
2	Set the number of data ([Ud-03]) and signals ([Ud-04]) to be traced.	
3	Select parameters to be traced. ([Ud-10]~[Ud-17])	
4	Select whether a signal to be traced is of input terminal function or output terminal function. ([Ud-20], [Ud-23], [Ud-26], [Ud-29], [Ud-32], [Ud-35], [Ud-38], [Ud-41]) Then, select a signal (terminal function) to be traced. (Input: [Ud-21], [Ud-24], [Ud-27], [Ud-30], [Ud-33], [Ud-36], [Ud-39], [Ud-42]) (Output: [Ud-22], [Ud-25], [Ud-28], [Ud-31], [Ud-34], [Ud-37], [Ud-40], [Ud-43])	
5	Select and set trigger conditions. ([Ud-50]~[Ud-59])	
6	Select sampling time (interval). ([Ud-60])	
7	Start tracing. (Set [Ud-02] to 01(Start).) (This item can also be set with the input terminal function DTR or “ProDriveNext”.)	
8	The inverter enters the trace stop state as tracing is completed. *1) *2) (Wait until the inverter finishes tracing.) When it's done, [Ud-02] will be changed to 00 (Stop).)	
9	Read out, show graphically, and store the accumulated trace data, using “ProDriveNext”. *3)	



- \*1) Note that the accumulated trace data will be erased if the inverter power supply is shut off.
- \*2) Do not interrupt tracing while it is being executed because some accumulated trace data may be remained.
- \*3) During data readout, trace data may be missing. In such a case, carry out readout again.

### 16.4.3 Trace function related parameters

#### ■ Related parameters

Item	Parameter	Data	Description
Trace function selection	[Ud-01]	00	Disable
		01	Enable
Trace start	[Ud-02]	00	Stop tracing.
		01	Start tracing and enters the trigger stand-by state.
Selection of the number of trace data (the number of parameters)	[Ud-03]	0~8	Select the number of data to be traced.
Trace signal selection	[Ud-04]	0~8	Select the number, of I/O signals to be traced.
Trace data 0 to 7 selection	[Ud-10]~[Ud-17]	See the trace target data described in the following section.	Select monitor parameters to be traced.
Trace signal 0 to 7 I/O selection	[Ud-20], [Ud-23], [Ud-26], [Ud-29], [Ud-32], [Ud-35], [Ud-38], [Ud-41]	00	Trace the input terminals. When 00 is selected, [Ud-21], [Ud-24], [Ud-27], [Ud-30], [Ud-33], [Ud-36], [Ud-39], [Ud-42] are enabled.
		01	Trace the output terminals. When 01 is selected, [Ud-22], [Ud-25], [Ud-28], [Ud-31], [Ud-34], [Ud-37], [Ud-40], [Ud-43] are enabled.
Trace signal 0 to 7 input terminal selection	[Ud-21], [Ud-24], [Ud-27], [Ud-30], [Ud-33], [Ud-36], [Ud-39], [Ud-42]	See options for [CA-01].	Set input terminal number to be traced.
Trace signal 0 to 7 output terminal selection	[Ud-22], [Ud-25], [Ud-28], [Ud-31], [Ud-34], [Ud-37], [Ud-40], [Ud-43]	See options for [CC-01].	Set output terminal number to be traced.
Selection of trace trigger 1, 2	[Ud-50], [Ud-54]	00	Set trip generation as trigger.
		01~08	Trace data 0 to 7 is trigger.
		09~16	Trace signal 0 to 7 is trigger.
Selection of trigger 1, 2 operation at trace data trigger	[Ud-51], [Ud-55]	00	Record the trace data when the trigger level rises.
		01	Record the trace data when the trigger level falls.
Trigger 1, 2 level at trace data trigger	[Ud-52], [Ud-56]	0~100 (%)	Adjust the trigger level, considering the Max. value of each selected monitor parameter as 100%.
Selection of trigger 1, 2 operation at trace signal trigger	[Ud-53], [Ud-57]	00	Record the trace data when the signal is ON.
		01	Record the trace data when the signal is OFF.
Trigger condition selection	[Ud-58]	00	Record the trace data when trigger 1 is satisfied.
		01	Record the trace data when trigger 2 is satisfied.
		02	Record when either of trigger 1 or 2 is satisfied.
		03	Record when both triggers 1 and 2 are satisfied.
Trigger point setting	[Ud-59]	0~100 (%)	Determine the trigger point for recording trace data.
Sampling time setting	[Ud-60]	01~10	Obtain data at the set intervals. 01 (0.2ms), 02 (0.5ms), 03 (1ms), 04 (2ms), 05 (5ms), 06 (10ms), 07 (50ms), 08 (100ms), 09 (500ms), 10 (1,000ms)
Input terminal function	[CA-01]~[CA-11]	108	DTR: Data trace starting signal
Output terminal function	[CC-01]~[CC-07]	078	WFT: Trace function trigger stand-by signal
	[CC-01]~[CC-07]	079	TRA: Trace function during-tracing signal

### ■ Trace target data

- Set the following monitor parameters to the trace data 0 to 7 selection ([Ud-10] to [Ud-17]).

Parameter No. and Name	Data Size (bytes)	Parameter No. and Name	Data Size (bytes)
dA-01 (Output frequency monitor)	4	db-30 (PID1 feedback data 1 monitor)	4
dA-02 (Output current monitor)	2	db-32 (PID1 feedback data 2 monitor)	4
dA-04 (Frequency command (after calculation))	4	db-34 (PID1 feedback data 3 monitor)	4
dA-08 (Speed detection value monitor)	4	db-36 (PID2 feedback data monitor)	4
dA-12 (Output frequency monitor (with sign))	4	db-38 (PID3 feedback data monitor)	4
dA-14 (Frequency upper limit monitor)	4	db-40 (PID4 feedback data monitor)	4
dA-15 (Torque command monitor (after calculation))	2	db-42 (PID1 target value monitor (after computing))	4
dA-16 (Torque limit monitor)	2	db-44 (PID1 feedback data monitor (after computing))	4
dA-17 (Output torque monitor)	4	db-50 (PID1 output monitor)	2
dA-18 (Output voltage monitor)	4	db-51 (PID1 deviation monitor)	2
dA-30 (Input power monitor)	2	db-52 (PID1 deviation 1 monitor)	2
dA-34 (Output power monitor)	2	db-53 (PID1 deviation 2 monitor)	2
dA-38 (Motor temperature monitor)	2	db-54 (PID1 deviation 3 monitor)	2
dA-40 (DC voltage monitor)	2	db-55 (PID2 output monitor)	2
dA-41 (BRD load factor monitor)	2	db-56 (PID2 deviation monitor)	2
dA-42 (Electronic thermal load factor monitor (MTR))	2	db-57 (PID3 output monitor)	2
dA-43 (Electronic thermal load factor monitor (CTL))	2	db-58 (PID3 deviation monitor)	2
dA-61 (Analog input [Ai1] monitor)	2	db-59 (PID4 output monitor)	2
dA-62 (Analog input [Ai2] monitor)	2	db-60 (PID4 deviation monitor)	2
dA-63 (Analog input [Ai3] monitor)	2	db-64 (PID feed forward monitor)	4
dA-64 (Extended analog input [Ai4] monitor)	2	dC-15 (Cooling fin temperature monitor)	2
dA-65 (Extended analog input [Ai5] monitor)	2	FA-01 (Main speed command (monitor + setting))	4
dA-66 (Extended analog input [Ai6] monitor)	2	FA-02 (Auxiliary speed command (monitor + setting))	4
dA-70 (Pulse train input monitor (main body))	2	FA-15 (Torque command monitor (monitor + setting))	2
dA-71 (Pulse train input monitor (option))	2	FA-16 (Torque bias monitor (monitor + setting))	2
db-18 (Analog output monitor YA0)	2	FA-30 (PID1 target value 1 (monitor + setting))	4
db-19 (Analog output monitor YA1)	2	FA-32 (PID1 target value 2 (monitor + setting))	4
db-20 (Analog output monitor YA2)	2	FA-34 (PID1 target value 3 (monitor + setting))	4
db-21 (Analog output monitor YA3)	2	FA-36 (PID2 target value (monitor + setting))	4
db-22 (Analog output monitor YA4)	2	FA-38 (PID3 target value (monitor + setting))	4
db-23 (Analog output monitor YA5)	2	FA-40 (PID4 target value (monitor + setting))	4

### ■ Data tracing time

- Data tracing time varies depending on the sampling time setting [Ud-60], the number of trace data [Ud-03], the number of trace signals [Ud-04], and data size of monitor parameters to be traced.

No. of Trace Data [Ud-03]	Data Tracing Time *1) *2)			
	Sampling time [Ud-60]: 01 (0.2ms) (Min.)		Sampling time [Ud-60]: 10 (1,000ms) (Max.)	
	If all are 4-byte data,	If all are 2-byte data,	If all are 4-byte data,	If all are 2-byte data,
1	344ms (1,724 points)	576ms (2,880 points)	1,724s (1,724 points)	2,880s (2,880 points)
2	190ms (953 points)	344ms (1,724 points)	953s (953 points)	1,724s (1,724 points)
3	131ms (656 points)	245ms (1,228 points)	656s (656 points)	1,228s (1,228 points)
4	100ms (500 points)	190ms (953 points)	500s (500 points)	953s (953 points)
5	80ms (402 points)	155ms (778 points)	402s (402 points)	778s (778 points)
6	67ms (336 points)	131ms (656 points)	336s (336 points)	656s (656 points)
7	57ms (288 points)	113ms (568 points)	288s (288 points)	568s (568 points)
8	50ms (252 points)	100ms (500 points)	252s (252 points)	500s (500 points)

\*1) For cases when the number of trace signals other than 0 is selected for [Ud-04].

\*2) "Points" in parentheses indicate the number of sampling points.

(Memo)

## 17

# Chapter 17 Connection with PLC

## Contents

17.1 What This Chapter Explains .....	17-1
17.2 Connection with PLC .....	17-2

### 17.1 What This Chapter Explains

This chapter describes the method for connecting the inverter with a programmable logic controller (PLC). Perform connection in accordance with the guidance given hereunder. Incorrect wiring may result in unexpected operations and breakage of the inverter and PLC. Furthermore, make sure to carefully read “Chapter 1 Safety Instructions/Risks” for safety work.



17.2 Connection with PLC

(1) Connecting input terminals to a programmable logic controller

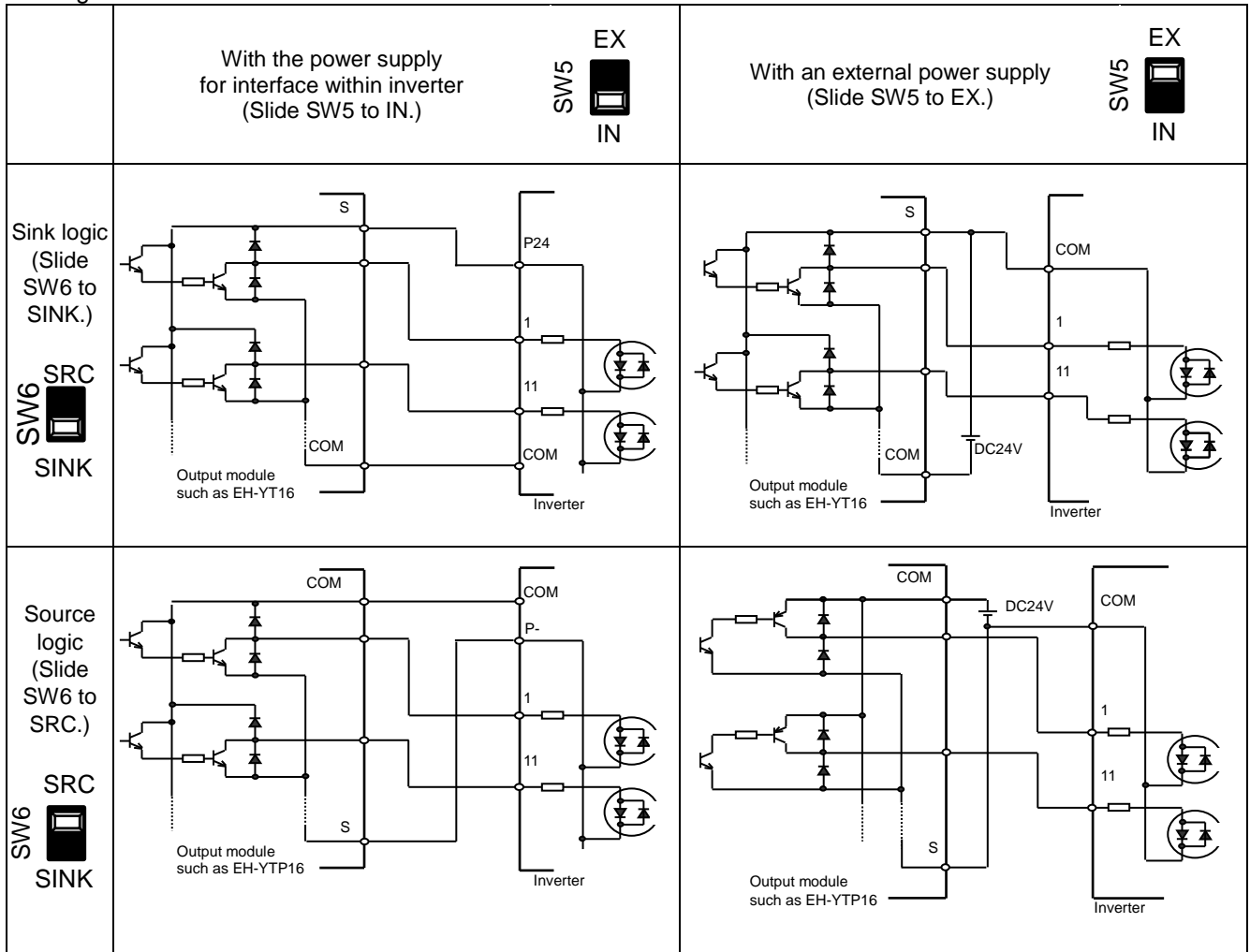

(2) Connecting output terminals to a programmable logic controller

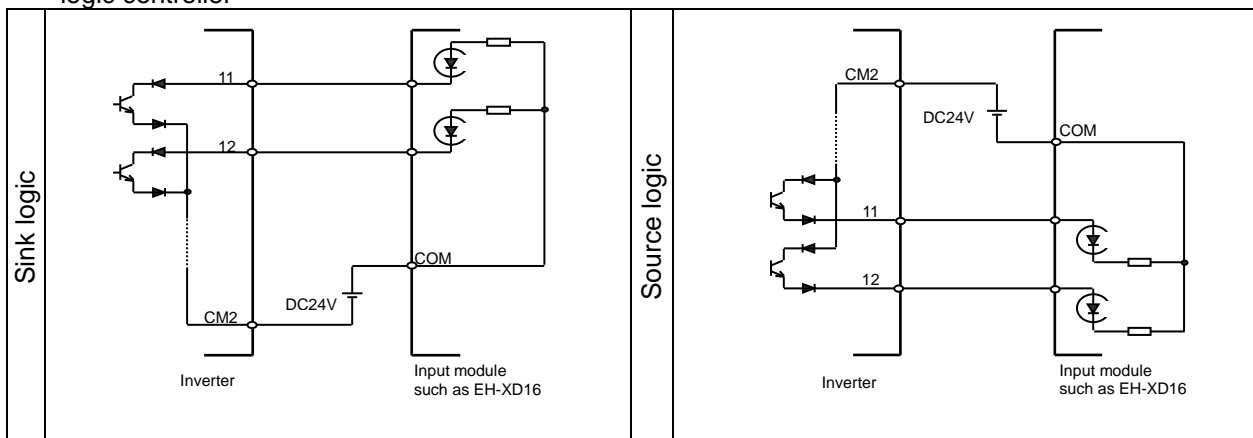

# 18

## Chapter 18 Tips/FAQ/Troubleshooting

### Contents

18.1 What This Chapter Explains..... 18-1

18.2 Self Diagnosis of Problems ..... 18-2

18.3 Checking Error Information ..... 18-3

    18.3.1 Checking trip information..... 18-3

    18.3.2 Checking retry information..... 18-4

18.4. Troubleshooting for Protection-function  
Related Errors..... 18-5

18.5. Troubleshooting for Warning-function  
Related Errors ..... 18-31

    18.5.1 Checking the warning display ..... 18-31





    18.5.2 Checking setting inconsistencies 18-36

    18.5.3 Checking display messages ..... 18-37

18.6 When Something Seems Wrong..... 18-40

### 18.1 What This Chapter Explains

This chapter provides troubleshooting information for protection-function related errors, warning-function related warnings, and “When something seems wrong”.

Symbol	Meanings
	General and troubleshooting questions
	Key points for a solution
	Notes
	Confirmation of procedures



- Read this chapter first when the inverter doesn't operate as intended or a problem occurred. Address these issues according to the circumstances by referring to the next and subsequent sections.

### 18.2 Self Diagnosis of Problems

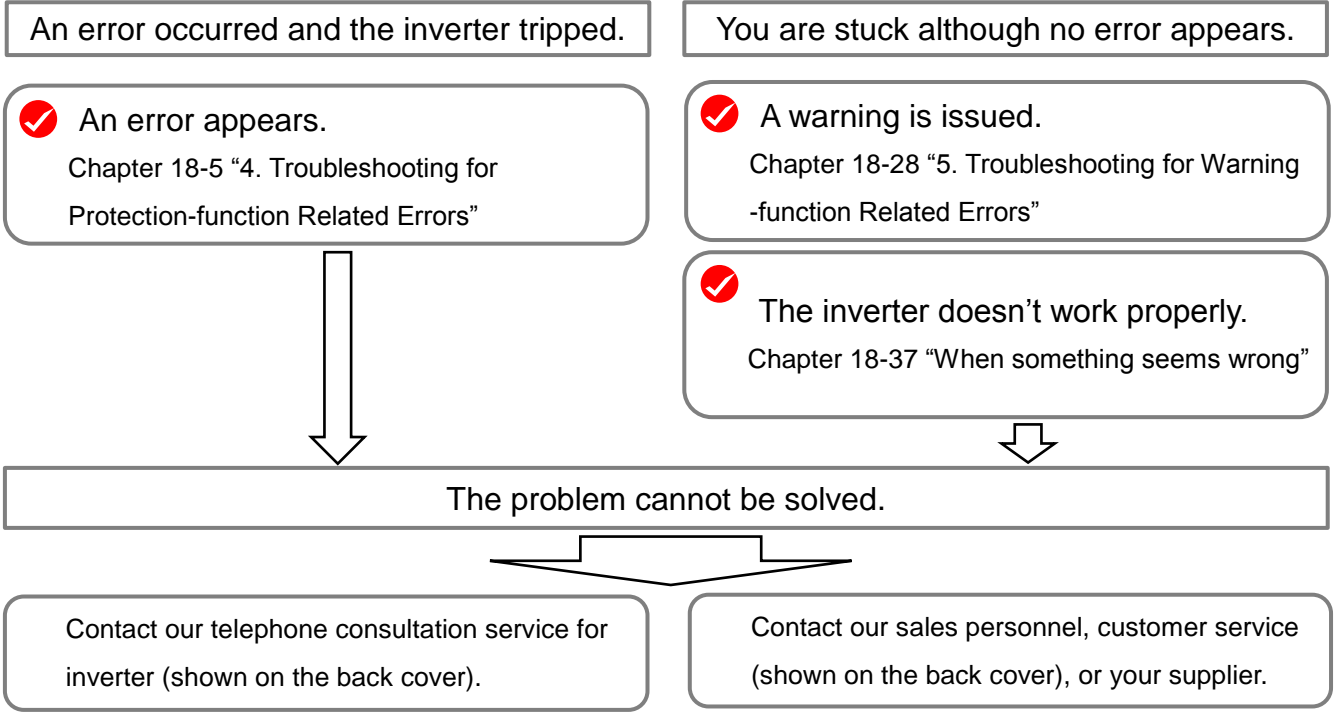

Before making an inquiry, please check the information shown on the right and have them ready.

(1) Inverter model, (2) Manufacturing number (MFG No.), (3) Date of purchase, and (4) Content of the inquiry

### 18.3 Checking Error Information

#### 18.3.1 Checking trip information

**Q**

- The inverter generated an error and tripped. You want to see the information of the moment the error occurred.

**A**

- Up to 10 trips in the past is displayed as the trip history.
- The latest trip history is displayed on the trip monitor 1.
- The following data items are displayed on the monitor:
  - Error factor for trip
  - Output frequency (Hz) at trip
  - Output current (A) at trip
  - Main circuit DC voltage (V) at trip
  - Operation state at trip
  - Cumulative inverter operating time (h) before trip
  - Cumulative inverter power-on time (h) before trip

**!**

- The information of the moment of error occurrence may not be fetched properly if the inverter is forcibly turned OFF by its hardware.
- Values of respective data items may be reset to 0 when an error occurred and the inverter entered the trip condition.
- For a ground fault or a momentary overcurrent event, the current may be recorded in a value lower than the actual value.
- The trip monitor and the trip count monitor can be cleared by initialization of the trip history.

■ Display of occurring trip

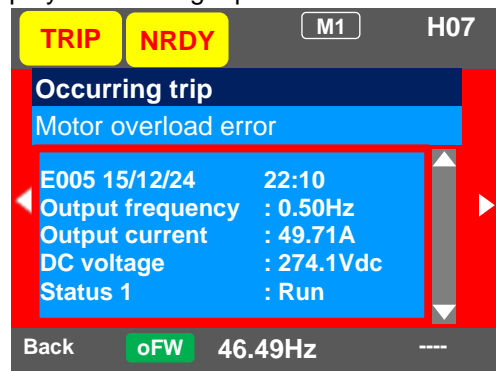

■ Parameter

Item	Parameter	Data	Description
Trip monitor 1 to 10	Detailed monitor	See above data items.	On the parameter monitor, you can view data items 1) to 7) in sequence by UP/DOWN keys.
Trip count monitor	Detailed monitor	0 - 65535 (Counts)	Trip count data is stored in the inverter.

■ “Detailed monitor” for checking the history

- You can look through the history with the arrow keys.

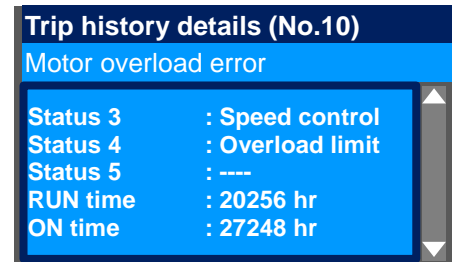
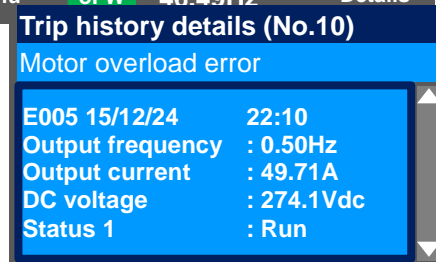
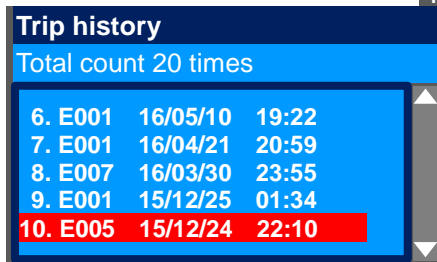
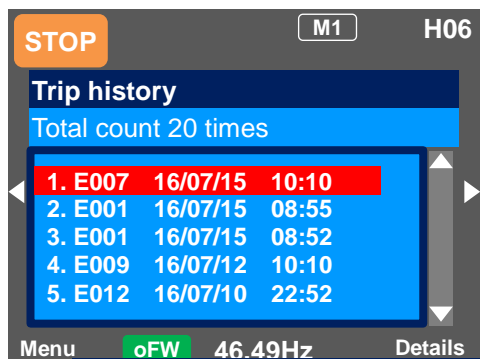

18.3.2 Checking retry information



- Want to see the information of the moment of error occurrence because a retry was executed after the inverter generated the error.



- The last 9 retry histories are displayed.
- The latest retry history is displayed on the retry monitor 1.
- The following data items are displayed on the monitor:
  - 1) Error factor for retry
  - 2) Output frequency (Hz) at retry
  - 3) Output current (A) at retry
  - 4) Main circuit DC voltage (V) at retry
  - 5) Operation state at retry
  - 6) Cumulative inverter operating time (h) before retry
  - 7) Cumulative inverter power-on time (h) before retry



- While a retry is underway, the inverter tries to continue running. For a trip after a retry, the trip information is recorded on the trip history.
- The information of the moment of error occurrence may not be fetched properly if the inverter is forcibly turned OFF by its hardware.
- For a momentary overcurrent event, the current may be recorded in a value lower than the actual value.

Parameter

Item	Parameter	Data	Description
Retry monitor 1 to 10	Detailed monitor 2	See above data items.	On the parameter monitor, you can view data items 1) to 7) in sequence by UP/DOWN keys.

“Detailed monitor 2” for checking the history

- You can look through the history with the arrow keys.

The image shows three screenshots of the inverter's parameter monitor interface. The top screenshot shows the 'Retry history' menu with a list of 5 entries. The bottom-left screenshot shows a scrollable list of 10 entries, with the 10th entry highlighted. The bottom-right screenshot shows the 'Retry history details (No.10)' screen, displaying specific error data for entry 10.

Entry	Error Code	Date	Time
1.	r007	16/07/14	20:10
2.	r009	16/07/14	18:54
3.	r009	16/07/14	08:32
4.	r009	16/07/14	06:18
5.	r001	16/07/12	22:49
6.	r001	16/07/10	19:22
7.	r001	16/07/01	15:39
8.	r009	16/06/24	21:44
9.	r001	16/06/20	01:34
10.	r007	16/06/12	21:11

Parameter	Value
Overvoltage error	r007 16/06/12 21:11
Output frequency	: 40.03Hz
Output current	: 11.22A
DC voltage	: 411.0Vdc
Status 1	: Run

Status	Value
Status 3	: Speed control
Status 4	: ----
Status 5	: ----
RUN time	: 19998 hr
ON time	: 25454 hr

## 18.4. Troubleshooting for Protection-function Related Errors

- You need to take a measure according to the error number and the type of error.  
Refer to the explanation pages shown in the table below.

Error No.	Error Name	Explanation Page
E001	Overcurrent error	18-7
E005	Motor overload error *2)	18-8
E006	Braking resistor overload error	18-9
E007	Overvoltage error	18-10
E008	Memory error	18-11
E009	Undervoltage error	18-12
E010	Current detector error *1)	18-13
E011	CPU error *1)	18-13
E012	External trip error	18-14
E013	USP error	18-14
E014	Ground fault error *1)	18-15
E015	Incoming overvoltage error	18-15
E016	Instantaneous power failure error	18-16
E019	Temperature detector error *1)	18-16
E020	Cooling fan rotation speed reduction temperature error *1)	18-17
E021	Temperature error	18-17
E024	Input open-phase error	18-18
E030	IGBT error	18-18
E034	Output open-phase error	18-19

Error No.	Error Name	Explanation Page
E035	Thermistor error	18-19
E036	Brake error	18-20
E038	Low-speed range overload error	18-20
E039	Controller overload error *2)	18-21
E040	Operator keypad disconnection error	18-22
E041	RS485 communication error	18-22
E042	RTC error	18-23
E043	EzSQ illegal instruction error	18-23
E044	EzSQ nest count error	18-24
E045	Executive instruction error	18-24
E050	EzSQ user-assigned error 0	18-25
E051	EzSQ user-assigned error 1	18-25
E052	EzSQ user-assigned error 2	18-25
E053	EzSQ user-assigned error 3	18-25
E054	EzSQ user-assigned error 4	18-25
E055	EzSQ user-assigned error 5	18-25
E056	EzSQ user-assigned error 6	18-25
E057	EzSQ user-assigned error 7	18-25
E058	EzSQ user-assigned error 8	18-25
E059	EzSQ user-assigned error 9	18-25

- \*1) When a serious fault error occurred, it cannot be released by a reset operation.
- \*2) When a controller overload error occurred, or a motor overload error occurred in the condition that [bC112] had been set to 00, the inverter does not accept a reset input for 10 s. Wait for a while before performing a reset operation.

Error No.	Error Name	Explanation Page
E060	Option 1 error 0	18-25
E061	Option 1 error 1	18-25
E062	Option 1 error 2	18-25
E063	Option 1 error 3	18-25
E064	Option 1 error 4	18-25
E065	Option 1 error 5	18-25
E066	Option 1 error 6	18-25
E067	Option 1 error 7	18-25
E068	Option 1 error 8	18-25
E069	Option 1 error 9	18-25
E070	Option 2 error 0	18-26
E071	Option 2 error 1	18-26
E072	Option 2 error 2	18-26
E073	Option 2 error 3	18-26
E074	Option 2 error 4	18-26
E075	Option 2 error 5	18-26
E076	Option 2 error 6	18-26
E077	Option 2 error 7	18-26
E078	Option 2 error 8	18-26
E079	Option 2 error 9	18-26
E080	Option 3 error 0	18-26
E081	Option 3 error 1	18-26
E082	Option 3 error 2	18-26
E083	Option 3 error 3	18-26
E084	Option 3 error 4	18-26
E085	Option 3 error 5	18-26
E086	Option 3 error 6	18-26
E087	Option 3 error 7	18-26
E088	Option 3 error 8	18-26
E089	Option 3 error 9	18-26

Error No.	Error Name	Explanation Page
E090	STO shutoff error	18-27
E091	STO internal error	18-27
E092	STO path 1 error	18-27
E093	STO path 2 error	18-27
E094	FS option internal error	18-27
E095	FS option path 1 error	18-27
E096	FS option path 2 error	18-27
E097	FS option connection error	18-27
E100	Encoder disconnection error	18-27
E104	Position control range error	18-27
E105	Speed deviation error	18-27
E106	Position deviation error	18-27
E107	Over-speed error	18-27
E110	Contact error	18-27
E112	FB option connection error	18-27

## E001 Overcurrent error

A large current flowing in the inverter results in a failure. To prevent this, the inverter turns OFF its output. By setting the parameter, you can perform retries for a fixed number of times without generating an error. Overcurrent level can be set in the [bb160].

# E001

Occurrence▶	Estimated cause(s)▶	Exemplar measures to be taken
Error occurred abruptly during operation.	<ul style="list-style-type: none"> <li>A steep load change occurred.</li> </ul>	<ul style="list-style-type: none"> <li>[bA120] Overcurrent suppression function and [bA122] Overload limit function are effective to suppress overcurrent.</li> <li>When the vector control is used, the situation may be improved by adjusting the response to control in [HA115].</li> </ul>
	<ul style="list-style-type: none"> <li>Hunting of motor</li> </ul>	<ul style="list-style-type: none"> <li>The situation may be improved by setting the IM motor capacity in [Hb102], the number of IM poles in [Hb103], or the auto-tuning selection in [HA-01].</li> <li>The situation may be improved by adjusting stabilization control gain in [HA110].</li> </ul>
Error occurred during acceleration.	<ul style="list-style-type: none"> <li>Insufficient acceleration time</li> <li>Insufficient acceleration torque</li> <li>Load inertia is large.</li> <li>Friction torque is large.</li> </ul>	<ul style="list-style-type: none"> <li>Setting longer acceleration time in [FA-10] can ease the insufficient acceleration torque.</li> <li>When acceleration torque is required, the situation may be improved by adjusting the boost function in [Hb141], or by operating the inverter and making adjustments with control method in [AA121].</li> <li>Re-examination of load condition may improve the situation.</li> </ul>
Error occurred during deceleration.	<ul style="list-style-type: none"> <li>Insufficient deceleration time</li> <li>Insufficient regenerative torque</li> <li>Load inertia is large.</li> </ul>	<ul style="list-style-type: none"> <li>Setting longer deceleration time in [FA-12] can ease the insufficient regenerative torque.</li> <li>When regenerative torque is required, the situation may be improved by adjusting the boost function in [Hb141], or by operating the inverter and making adjustments with control method in [AA121].</li> </ul>
Error occurred right after an operation command input.	<ul style="list-style-type: none"> <li>A ground fault has occurred.</li> <li>Output line is short-circuited or in open phase.</li> <li>Output element failure</li> </ul>	<ul style="list-style-type: none"> <li>The inverter may be broken if the error persists even when the power of inverter only is turned ON again after the power was turned OFF and the output line to the motor was removed.</li> <li>If the issue is solved when the output line to the motor is removed, you need to check the wiring and/or motor.</li> </ul>
	<ul style="list-style-type: none"> <li>Motor is locked.</li> <li>Load inertia is large.</li> </ul>	<ul style="list-style-type: none"> <li>Error may occur when the motor rotation is locked.</li> <li>The situation may be improved by taking a measure for the case "Error occurred during acceleration".</li> </ul>
Error occurred right after power was turned ON.	<ul style="list-style-type: none"> <li>Output element failure</li> <li>Current detector failure</li> </ul>	<ul style="list-style-type: none"> <li>Failure output element or current detector may be the cause. An investigation and repair are required.</li> </ul>
Error occurred after long hours of use.	<ul style="list-style-type: none"> <li>System environment changes</li> </ul>	<ul style="list-style-type: none"> <li>The situation may be improved by reducing the motor load, or performing a system maintenance (e.g., cleaning the fan to be driven and removing clogging in the duct).</li> </ul>
	<ul style="list-style-type: none"> <li>Aging deterioration</li> </ul>	<ul style="list-style-type: none"> <li>If the issue is not solved by reduction of the load and system maintenance, aging deterioration of a life-limited component may be the cause. A repair is required.</li> </ul>



## E005 Motor overload error

The built-in electronic thermal function monitors the output current of the inverter and when a motor overload is detected, the inverter turns OFF its output. The inverter trips according to the setting of the motor electronic thermal function.

When a motor overload error occurred, the inverter does not accept a reset input for 10 seconds.



**E005**

Occurrence ▶	Estimated cause(s) ▶	Exemplar measures to be taken
Error occurred after a fixed period of operation.	<ul style="list-style-type: none"> <li>• Operation under heavy load condition has continued.</li> </ul>	<ul style="list-style-type: none"> <li>• Re-examination of operation condition or correction of load condition may improve the situation.</li> </ul>
	<ul style="list-style-type: none"> <li>• Thermal level is set high.</li> </ul>	<ul style="list-style-type: none"> <li>• When the motor thermal level setting in [bC110] is not appropriate, re-examination of the setting may improve the situation.</li> </ul>
Error occurred during acceleration.	<ul style="list-style-type: none"> <li>• Insufficient acceleration torque</li> <li>• Load inertia is large.</li> <li>• Friction torque is large.</li> </ul>	<ul style="list-style-type: none"> <li>• Setting longer acceleration time in [FA-10] can ease the insufficient acceleration torque.</li> <li>• When acceleration torque is required, the situation may be improved by adjusting the boost function in [Hb141], or by operating the inverter and making adjustments with control method in [AA121].</li> </ul>
	<ul style="list-style-type: none"> <li>• A function to suppress overcurrent is at work.</li> </ul>	<ul style="list-style-type: none"> <li>• A factor for overcurrent may have been occurred. Re-examination of acceleration time or load condition is required.</li> </ul>
Error occurred during deceleration.	<ul style="list-style-type: none"> <li>• Load inertia is large.</li> </ul>	<ul style="list-style-type: none"> <li>• Setting longer deceleration time in [FA-12] can ease the insufficient regenerative torque.</li> <li>• When regenerative torque is required, the situation may be improved by adjusting the boost function in [Hb141], or by operating the inverter and adjusting with control method in [AA121].</li> <li>• Re-examination of load condition may improve the situation.</li> </ul>
	<ul style="list-style-type: none"> <li>• A function to suppress overvoltage is at work.</li> </ul>	<ul style="list-style-type: none"> <li>• Current may increase as a result of suppressing overvoltage. Re-examination of deceleration time or load condition in [FA-12] is required.</li> </ul>
Error occurred after long hours of use.	<ul style="list-style-type: none"> <li>• System environment changes</li> </ul>	<ul style="list-style-type: none"> <li>• The situation may be improved by reducing the motor load, or performing a system maintenance (e.g., cleaning the fan to be driven and removing clogging in the duct).</li> </ul>
	<ul style="list-style-type: none"> <li>• Aging deterioration</li> </ul>	<ul style="list-style-type: none"> <li>• If the issue is not solved by reduction of the load and system maintenance, aging deterioration of a life-limited component may be the cause. A repair is required.</li> </ul>

## E006 Braking resistor overload error

**E006**

When the use rate of inverter's braking resistor operation circuit (BRD) exceeds the use rate set beforehand in [bA-60], the inverter turns OFF its output.

Occurrence ▶	Estimated cause(s) ▶	Exemplar measures to be taken
Error occurred during deceleration.	<ul style="list-style-type: none"> <li>• Insufficient deceleration time</li> <li>• Load inertia is large.</li> <li>• Capacity of braking resistor is small.</li> </ul>	<ul style="list-style-type: none"> <li>• Setting longer deceleration time in [FA-12] may improve the situation that the motor is rapidly decelerated. If deceleration time cannot be shortened, choice of resistor must be re-examined.</li> </ul>
Error occurred during operation.	<ul style="list-style-type: none"> <li>• Continuous regenerative operation</li> <li>• Capacity of braking resistor is small.</li> </ul>	<ul style="list-style-type: none"> <li>• The resistor may not be able to fully consume the power because the regenerative power returned from the motor is high. Load condition or choice of resistor must be re-examined.</li> </ul>
	<ul style="list-style-type: none"> <li>• Rotated by external force.</li> </ul>	<ul style="list-style-type: none"> <li>• The resistor may not be able to fully consume the power because the fan is rotated by a strong wind, or because the regenerative power returned from the motor increases when loads are lowered by a crane or the like. Load condition or choice of resistor must be re-examined.</li> </ul>
Error occurred during repetitive operations.	<ul style="list-style-type: none"> <li>• Repetition cycle of operation is high.</li> </ul>	<ul style="list-style-type: none"> <li>• Reduction of repetition cycle of operation may improve the situation. Adjustment of deceleration time in [FA-12] and re-examination of choice of resistor may also improve the situation.</li> </ul>

## E007 Overvoltage error

Too high P-N voltage results in a failure. To prevent this, the inverter turns OFF its output. When P-N voltage exceeds approx. 410Vdc (200V class) or approx. 820Vdc (400V class), the output is turned OFF. By setting the parameter, you can perform retries for a fixed number of times without generating an error.



Occurrence ▶	Estimated cause(s) ▶	Exemplar measures to be taken
Error occurred during deceleration.	<ul style="list-style-type: none"> <li>Insufficient deceleration time</li> <li>Load inertia is large.</li> </ul>	<ul style="list-style-type: none"> <li>Setting longer deceleration time in [FA-12] may improve the situation that the motor is rapidly decelerated. If deceleration time cannot be shortened, you need to re-examine load condition, enable overvoltage suppression function in [bA140] and [bA146], or use a braking resistor, braking unit, or regenerative converter.</li> </ul>
Error occurred during operation.	<ul style="list-style-type: none"> <li>Load inertia is large.</li> </ul>	<ul style="list-style-type: none"> <li>If load inertia is large, high regenerative power returns from the motor; hence an overvoltage is likely to occur. You need to re-examine load condition, enable overvoltage suppression function in [bA140] and [bA146], or use a braking resistor, braking unit, or regenerative converter.</li> </ul>
	<ul style="list-style-type: none"> <li>Rotated by external force (fan, crane).</li> </ul>	<ul style="list-style-type: none"> <li>An overvoltage is likely to occur if motor rotation speed exceeds the output frequency (rotation speed) of inverter. You need to re-examine load condition, enable overvoltage suppression function in [bA140] and [bA146], or use a braking resistor, braking unit, or regenerative converter.</li> </ul>
Error occurred during stop.	<ul style="list-style-type: none"> <li>Abnormality of PS voltage</li> </ul>	<ul style="list-style-type: none"> <li>Power supply voltage may be raised or fluctuated. Re-examination of power supply environment or use of an AC reactor may improve the situation.</li> </ul>
Error occurred during drooping control	<ul style="list-style-type: none"> <li>Mutual interference caused by 2 inverters trying to control motors strictly.</li> </ul>	<ul style="list-style-type: none"> <li>When 2 motors driving a same shaft are controlled by 2 inverters, both the inverters attempt to generate torques, which may result in control divergence. The situation may be improved by setting one of the inverters to P control. See "12.11.3 Perform Drooping Control".</li> </ul>

## E008 Memory error

If the built-in memory has problems, the inverter turns OFF its output. CPU error may be issued instead.

The inverter recovers by re-turning ON the power; however, you need to check that there is no problem in parameters. The data which has been backed up on the operator keypad beforehand may be restored.



**E008**

Occurrence ▶	Estimated cause(s) ▶	Exemplar measures to be taken
Error occurred some time after the power was turned ON.	<ul style="list-style-type: none"> <li>Noise is mixed.</li> </ul>	<ul style="list-style-type: none"> <li>A physical countermeasure such as placing a shielding plate may be required to avoid external noises.</li> </ul>
Power has been unintentionally turned OFF before.	<ul style="list-style-type: none"> <li>Power-off during memory access</li> </ul>	<ul style="list-style-type: none"> <li>You need to restore the data by using the data which has been backed up on the operator keypad beforehand. If the data cannot be restored, initialization is required. See “12.2.2 Initialization of inverter”.</li> <li>If the data cannot be restored by initialization, a repair is required.</li> </ul>

## E009 Undervoltage error



A decrease of the main power supply of inverter results in a circuit breakage. To prevent this, the inverter turns OFF its output. When P-N voltage falls below approx. 160Vdc (200V class) or approx. 320VDC (400V class), the output is turned OFF. By setting the parameter, you can perform retries for a fixed number of times without generating an error. Furthermore, undervoltage error during stop can be disabled by setting.

Occurrence ▶	Estimated cause(s) ▶	Exemplar measures to be taken
There was a power failure.	<ul style="list-style-type: none"> <li>• PS voltage decreased.</li> </ul>	<ul style="list-style-type: none"> <li>• If the internal power supply hasn't been fully turned OFF, it is possible to re-start the inverter after the power supply is recovered, by setting the retry function while it is still on.</li> </ul>
Error occurred with the start of operation.	<ul style="list-style-type: none"> <li>• PS voltage decreased.</li> <li>• PS capacity is insufficient.</li> </ul>	<ul style="list-style-type: none"> <li>• When power supply voltage decreases or power supply capacity is insufficient, re-examination of power supply environment is required.</li> </ul>
The inverter doesn't start.	<ul style="list-style-type: none"> <li>• PS voltage is insufficient.</li> </ul>	<ul style="list-style-type: none"> <li>• Perform power supplying in accordance with the inverter voltage class.</li> </ul>
Error occurred after long hours of use.	<ul style="list-style-type: none"> <li>• System environment changes</li> <li>• Capacitor deterioration</li> <li>• Circuit failure</li> </ul>	<ul style="list-style-type: none"> <li>• If an undervoltage occurs frequently, the inverter may have reached its end of life or be broken down. A repair is required.</li> </ul>

## E010 Current detector error

If the built-in current detector has problems, the inverter turns OFF its output.

**E010**

Occurrence ▶	Estimated cause(s) ▶	Exemplar measures to be taken
Error occurred after power was turned ON.	<ul style="list-style-type: none"> <li>• Current detector circuit is broken.</li> <li>• A noise source is nearby.</li> </ul>	<ul style="list-style-type: none"> <li>• If the error recurs after a reset operation, the current detector circuit may be broken down. A repair is required.</li> <li>• When there is a noise source nearby, the situation may be improved by taking a noise countermeasure such as keeping the noise source away or placing a shielding plate.</li> </ul>
Error occurred after long hours of use.	<ul style="list-style-type: none"> <li>• Current detector circuit is broken.</li> </ul>	<ul style="list-style-type: none"> <li>• If the error recurs after a reset operation, the current detector circuit may be broken down. A repair is required.</li> </ul>

## E011 CPU error

When a malfunction or problem occurs in the built-in CPU, the inverter turns OFF its output and then displays the error.

If the inverter doesn't recover by re-turning ON the power, the CPU is likely to be broken.

**E011**

Occurrence ▶	Estimated cause(s) ▶	Exemplar measures to be taken
Error occurred abruptly.	<ul style="list-style-type: none"> <li>• The internal CPU is broken.</li> <li>• A noise source is nearby.</li> </ul>	<ul style="list-style-type: none"> <li>• The inverter may recover by a reset operation, re-turning ON the power, or initialization operation. When the inverter recovered, an initialization must be executed.</li> <li>• If the inverter doesn't recover, the CPU may be broken down. A repair is required.</li> <li>• Where there is a noise source nearby, the situation may be improved by taking a noise countermeasure such as keeping the noise source away or placing a shielding plate.</li> </ul>
Error occurred during data writing.	<ul style="list-style-type: none"> <li>• Data is inconsistent.</li> </ul>	<ul style="list-style-type: none"> <li>• The inverter may recover by a reset operation, re-turning ON the power, or initialization operation. When the inverter recovered, an initialization must be executed. See "12.2.2 Initialization of inverter".</li> </ul>

## E012 External trip error

When the inverter accepted a signal commanded by an external device or equipment, the inverter turns OFF its output. (When external trip function is selected.)



**E012**

Occurrence ▶	Estimated cause(s) ▶	Exemplar measures to be taken
Error occurred unintentionally.	<ul style="list-style-type: none"> <li>Terminal logics are reversed.</li> <li>Wiring is wrong.</li> </ul>	<ul style="list-style-type: none"> <li>You need to check the state of operations related to external devices or external equipment, and re-examine the assignment of external trip terminal to the inverter input terminal, the setting of a/b contact, the external trip command via communication, etc.</li> <li>A/b contact of terminal can be changed by inverter setting.</li> </ul>

## E013 USP error

This error occurs if an operation command has been input to the inverter when the power supply is turned ON. Operation command detection is carried out for 1 second after the power supply is turned ON. (When USP function is selected.)



**E013**

Occurrence ▶	Estimated cause(s) ▶	Exemplar measures to be taken
Error occurred unintentionally.	<ul style="list-style-type: none"> <li>Operation command was entered too early.</li> </ul>	<ul style="list-style-type: none"> <li>Re-examination of the sequence to enter operation command is required. You need to wait for 2 seconds or longer to enter operation command after turning ON the power supply.</li> </ul>
	<ul style="list-style-type: none"> <li>Operation command isn't released.</li> </ul>	<ul style="list-style-type: none"> <li>You need to release an operation command when turning ON the power supply.</li> </ul>
	<ul style="list-style-type: none"> <li>You tried to operate with commands other than terminal commands.</li> </ul>	<ul style="list-style-type: none"> <li>When USP is enabled, commands of the operator keypad and communication commands are treated as errors. You need to wait for 2 seconds or longer to enter operation command after turning ON the power supply.</li> </ul>

## E014 Ground fault error



This is a function to protect the inverter by the detection of ground faults between the inverter output and the motor at power-on.

The function doesn't work when there is a voltage induced in the motor due to idling or when the inverter trips.

When the control circuit power (R0, T0, or 24V power supply) has been turned ON prior to the main circuit power R, S, or T, the function is activated at the time the main circuit power is turned ON.

Setting the ground fault detection selection [bb-64] to 00 disables the ground fault function. Setting it to 01 enables the function.

Occurrence ▶	Estimated cause(s) ▶	Exemplar measures to be taken
Error occurred as the power supply was turned ON.	<ul style="list-style-type: none"> <li>• Ground faults of wires or the motor</li> <li>• Motor insulation deterioration</li> </ul>	<ul style="list-style-type: none"> <li>• Turn OFF the power, remove the wires connected to the motor, and then check the motor and the wires. A ground fault may have been occurred.</li> <li>• Turning ON the power supply in a ground fault state results in a failure. Do not turn ON the power when you check the motor and motor wires.</li> </ul>

## E015 Incoming overvoltage error



This error occurs if high incoming voltage level is held for 100 seconds continuously while the inverter output is stopped when incoming overvoltage level [bb-61] is set to 01. It occurs when the P-N voltage exceeds the voltage level set in the incoming overvoltage level selection [bb-62] due to incoming voltage.

Occurrence ▶	Estimated cause(s) ▶	Exemplar measures to be taken
Error occurred after power was turned ON.	<ul style="list-style-type: none"> <li>• Incoming voltage is high.</li> </ul>	<ul style="list-style-type: none"> <li>• Re-examination of the power supply environment is required.</li> </ul>
Error occurred after long hours of use.	<ul style="list-style-type: none"> <li>• Power supply has become unstable.</li> </ul>	<ul style="list-style-type: none"> <li>• The power supply environment may have been changed due to facility replacement or the like. Re-examination of the power supply environment is required.</li> </ul>



## E016 Instantaneous power failure error

**E016**

At the time of an instantaneous power failure, the inverter turns OFF its output. If the power failure continues, the event is regarded as a normal power-off.

Decrease in the main power R, S, or T generates this error. Decrease in the voltage of control circuit power supply R0 or T0 doesn't generate the error if the J51 connector has been removed and the R0 and T0 are input via a separate system.

Occurrence ▶	Estimated cause(s) ▶	Exemplar measures to be taken
Error occurred after long hours of use.	• PS voltage decreased.	• If the power is turned OFF due to an external factor such as power failure, the inverter can be restarted by using the retry function when the power is restored.
	• There was a contact fault in circuit breaker.	• Failure of magnetic contactor or earth-leakage breaker may be the cause. Although the inverter may recover, a repair is required.
Error occurred with the start of operation.	• PS voltage decreased.	• If an instantaneous power failure hasn't occurred, insufficient capacity of power supply may be the cause. Re-examination of the power supply environment is required.

## E019 Temperature detector error

**E019**

This error occurs if there is a problem in the temperature detector circuit such as disconnection.

Occurrence ▶	Estimated cause(s) ▶	Exemplar measures to be taken
Error occurred after use.	• The temperature detector circuit is disconnected or broken down.	• The temperature detector circuit is broken down. A repair is required.

## E020 Temperature error Cooling fan rotation speed reduction error



If the temperature of inverter gets high due to deterioration of cooling ability resulted from decrease in fan rotation speed, the inverter turns OFF its output. Refer to E021 also.

Occurrence ▶	Estimated cause(s) ▶	Exemplar measures to be taken
Cooling fan stopped.	<ul style="list-style-type: none"> <li>• A foreign object is stuck.</li> <li>• It is the end of cooling fan life.</li> </ul>	<ul style="list-style-type: none"> <li>• If there is a foreign object stuck in the fan, the inverter may recover by removing it.</li> <li>• The cooling fan needs to be replaced.</li> </ul>
The cooling fan is working.	<ul style="list-style-type: none"> <li>• Cooling fan is approaching the end of its life.</li> </ul>	<ul style="list-style-type: none"> <li>• The cooling ability has been deteriorated. The cooling fan needs to be replaced.</li> </ul>

## E021 Temperature error

When the temperature of inverter gets high, the inverter turns OFF its output.



Occurrence ▶	Estimated cause(s) ▶	Exemplar measures to be taken
Error occurred during operation.	<ul style="list-style-type: none"> <li>• Carrier frequency is high.</li> </ul>	<ul style="list-style-type: none"> <li>• The higher the carrier frequency is, the more the temperature inside the inverter tends to increase. Lower the carrier frequency setting.</li> </ul>
	<ul style="list-style-type: none"> <li>• There is clogging in the fin.</li> </ul>	<ul style="list-style-type: none"> <li>• The cooling ability is deteriorated. Cleaning the fin may improve the situation.</li> </ul>
	<ul style="list-style-type: none"> <li>• Used in high temperature environment.</li> <li>• Cooling of the surroundings is insufficient..</li> </ul>	<ul style="list-style-type: none"> <li>• Enhancing the use environment or cooling environment may improve the situation.</li> </ul>
	<ul style="list-style-type: none"> <li>• The formal installation condition is not satisfied.</li> </ul>	<ul style="list-style-type: none"> <li>• Improper installation of the inverter may results in the inverter failure. Install the inverter properly in accordance with the instruction manual.</li> </ul>
Error occurred during stop.	<ul style="list-style-type: none"> <li>• The temperature detector circuit broke down.</li> </ul>	<ul style="list-style-type: none"> <li>• The temperature detector circuit is broken down if the error is generated consecutively even after a reset. A repair is required.</li> </ul>

## E024 Input open-phase error

**E024**

When [bb-65] input phase loss selection is set to 01, when a missing phase is detected in input line, the inverter turns OFF its output.

Occurrence ▶	Estimated cause(s) ▶	Exemplar measures to be taken
Error occurred after power was turned ON.	<ul style="list-style-type: none"> <li>An input line or the motor has a loose connection or is disconnected.</li> <li>Single-phase input is used.</li> </ul>	<ul style="list-style-type: none"> <li>You need to turn OFF the power supply and check the input lines and the wiring condition of breaker. This error may also occur due to PS voltage defect, contact defect, screw tightening failure, etc.</li> <li>For input lines, use three-phase connection.</li> </ul>
Error occurred after long hours of use.	<ul style="list-style-type: none"> <li>An input line or breaker has a loose connection or is disconnected.</li> </ul>	<ul style="list-style-type: none"> <li>The situation may be improved by mending loose connections due to loosening of screws or the breaker problems.</li> </ul>

## E030 IGBT error

**E030**

At the time of an instantaneous overcurrent or the main element failure, the inverter turns OFF its output to protect the main element.  
Overcurrent error may be issued instead.

Occurrence ▶	Estimated cause(s) ▶	Exemplar measures to be taken
Error occurred right after the operation started.	<ul style="list-style-type: none"> <li>A ground fault has occurred.</li> <li>Output line is short-circuited.</li> <li>Motor rotation is locked.</li> <li>Output element is broken down.</li> </ul>	<ul style="list-style-type: none"> <li>After the power is turned OFF, you need to check the wires connected to the motor, motor disconnection, and the like. If the error occurs after removal of the motor wires, the inverter is broken down. It needs to be repaired.</li> <li>A large current may flow when the motor rotation is locked during operation. The cause needs to be removed.</li> <li>If output element is broken down, it needs to be repaired.</li> </ul>
Error occurred right after power was turned ON.	<ul style="list-style-type: none"> <li>Output element is broken down.</li> </ul>	<ul style="list-style-type: none"> <li>If output element is broken down, it needs to be repaired.</li> </ul>
Error occurred during operation.	<ul style="list-style-type: none"> <li>Motor rotation is locked.</li> </ul>	<ul style="list-style-type: none"> <li>A large current may flow when the motor rotation is locked during operation. The cause needs to be removed.</li> </ul>

## E034 Output open-phase error

**E034**

When the output phase loss selection [bb-66] is set to 01, when a loose connection or disconnection of output line, disconnection inside the motor, etc. is detected, the inverter turns OFF its output. Detection of phase loss state is executed in the section between 5Hz to 100Hz.

Occurrence ▶	Estimated cause(s) ▶	Exemplar measures to be taken
Error occurred right after the operation started.	<ul style="list-style-type: none"> <li>An output line or the motor has a loose connection or is disconnected.</li> </ul>	<ul style="list-style-type: none"> <li>You need to turn OFF the power supply and check the output lines and the wiring condition of motor. This error can also occur due to motor insulation breakdown or screw tightening failure.</li> </ul>
	<ul style="list-style-type: none"> <li>Single-phase output is used.</li> </ul>	<ul style="list-style-type: none"> <li>For output lines, use three-phase connection.</li> </ul>
Error occurred after long hours of operation.	<ul style="list-style-type: none"> <li>An output line or the motor has a loose connection or is disconnected.</li> </ul>	<ul style="list-style-type: none"> <li>You need to turn OFF the power supply and check the output lines and the wiring condition of motor. If there is a loosened screw, the situation may be improved by re-tightening the screw.</li> </ul>

## E035 Thermistor error

**E035**

If an abnormal temperature is observed during detection of resistor level change in an external thermistor, the inverter turns OFF its output. (When thermistor function is enabled.)

Occurrence ▶	Estimated cause(s) ▶	Exemplar measures to be taken
Motor is heated.	<ul style="list-style-type: none"> <li>The motor hasn't been cooled sufficiently.</li> </ul>	<ul style="list-style-type: none"> <li>The cooling environment needs to be improved.</li> </ul>
	<ul style="list-style-type: none"> <li>Heavy load has been applied for a long time.</li> </ul>	<ul style="list-style-type: none"> <li>The motor's driving environment needs to be re-examined.</li> </ul>
Motor is not heated.	<ul style="list-style-type: none"> <li>Inadequate thermistor function setting</li> </ul>	<ul style="list-style-type: none"> <li>Re-examination of the thermistor function setting may improve the situation.</li> </ul>
	<ul style="list-style-type: none"> <li>The thermistor is broken down.</li> </ul>	<ul style="list-style-type: none"> <li>The thermistor needs to be repaired.</li> </ul>
	<ul style="list-style-type: none"> <li>Malfunction due to noise</li> </ul>	<ul style="list-style-type: none"> <li>The situation may be improved by taking a noise countermeasure such as wiring separation.</li> </ul>

## E036 Brake error

This error occurs when the inverter can not detect whether the brake check signal is ON or OFF during waiting time after the inverter has output a brake releasing signal. (When brake function is enabled.)

**E036**

Occurrence ▶	Estimated cause(s) ▶	Exemplar measures to be taken
Error occurred after operation.	<ul style="list-style-type: none"> <li>• Disconnection of signal line.</li> <li>• Brake function setting</li> </ul>	<ul style="list-style-type: none"> <li>• Check the wiring of brake check signal and whether the signal is ON or OFF.</li> <li>• The situation may be improved by re-examination of brake check waiting time or input terminal logics according to the sequence of the signal.</li> </ul>

## E038 Low-speed range overload error

This error occurs to protect the main element if the inverter has output at a low frequency of 0.2Hz or below.

When such a low frequency is detected by the built-in electronic thermal function, the inverter turns OFF its output.

**E038**

Occurrence ▶	Estimated cause(s) ▶	Exemplar measures to be taken
Error occurred during output at low speed.	<ul style="list-style-type: none"> <li>• The motor load is heavy.</li> </ul>	<ul style="list-style-type: none"> <li>• Load at low-speed range needs to be reduced. If the error occurs frequently, you need to select an inverter with a capacity large enough for the motor.</li> </ul>

## E039 Controller (inverter) overload error

**E039**

The built-in electronic thermal function monitors the output current of the inverter (controller) and when inverter overload is detected, the inverter turns OFF its output.

Occurrence ▶	Estimated cause(s) ▶	Exemplar measures to be taken
Error occurred after a fixed period of operation.	<ul style="list-style-type: none"> <li>• Operation under heavy load condition has continued.</li> </ul>	<ul style="list-style-type: none"> <li>• Re-examination of operation condition or correction of load condition may improve the situation.</li> </ul>
Error occurred during acceleration.	<ul style="list-style-type: none"> <li>• Insufficient acceleration torque</li> <li>• Load inertia is large.</li> <li>• Friction torque is large.</li> </ul>	<ul style="list-style-type: none"> <li>• Setting longer acceleration time in [FA-10] can ease the insufficient acceleration torque.</li> <li>• When acceleration torque is required, the situation may be improved by adjusting the boost function in [Hb141], or by operating the inverter and making adjustments with control method in [AA121].</li> </ul>
	<ul style="list-style-type: none"> <li>• A function to suppress overcurrent is at work.</li> </ul>	<ul style="list-style-type: none"> <li>• A factor for overcurrent may have been occurred. Re-examination of acceleration time or load condition is required.</li> </ul>
Error occurred during deceleration.	<ul style="list-style-type: none"> <li>• Load inertia is large.</li> </ul>	<ul style="list-style-type: none"> <li>• Insufficient rotation regeneration torque can be eased by setting longer deceleration time in [FA-12].</li> <li>• When regenerative torque is required, the situation may be improved by adjusting the boost function in [Hb141], or by operating the inverter and adjusting with control method in [AA121].</li> <li>• Re-examination of load condition may improve the situation.</li> </ul>
	<ul style="list-style-type: none"> <li>• A function to suppress overvoltage is at work.</li> </ul>	<ul style="list-style-type: none"> <li>• Current may increase as a result of suppressing overvoltage. Re-examination of deceleration time or load condition is required.</li> </ul>
Error occurred after long hours of use.	<ul style="list-style-type: none"> <li>• System environment changes</li> </ul>	<ul style="list-style-type: none"> <li>• The situation may be improved by reducing the motor load, or performing a system maintenance (e.g., cleaning the fan to be driven and removing clogging in the duct).</li> </ul>
	<ul style="list-style-type: none"> <li>• Aging deterioration</li> </ul>	<ul style="list-style-type: none"> <li>• If the issue is not solved by reduction of the load and system maintenance, aging deterioration of a life-limited component may be the cause. A repair is required.</li> </ul>

## E040 Operator keypad communication error

**E040**

The inverter displays this error when timeout occurs because of a malfunction due to noises, loose connection or disconnection of circuit for communication with the operator keypad.

This error function can be enabled and disabled by setting of the operation selection at disconnection of operator keypad [UA-20].

Occurrence ▶	Estimated cause(s) ▶	Exemplar measures to be taken
Error occurred after communication is started.	<ul style="list-style-type: none"> <li>• Loose connection</li> <li>• Disconnection</li> </ul>	<ul style="list-style-type: none"> <li>• Check the wiring to see whether the connection is properly made.</li> </ul>
	<ul style="list-style-type: none"> <li>• Noise is mixed.</li> </ul>	<ul style="list-style-type: none"> <li>• The situation may be improved by taking a noise countermeasure such as wiring separation.</li> </ul>

## E041 RS485 communication error

**E041**

The inverter displays this error only when timeout occurs because of a malfunction due to noises, loose connection or disconnection of circuit for RS485 communication (such as Modbus-RTU).

This error function can be enabled and disabled by setting of the communication error selection [CF-05].

Occurrence ▶	Estimated cause(s) ▶	Exemplar measures to be taken
Error occurred after communication is started.	<ul style="list-style-type: none"> <li>• Loose connection</li> <li>• Disconnection</li> </ul>	<ul style="list-style-type: none"> <li>• Check the wiring to see whether or not the connection is properly made.</li> </ul>
	<ul style="list-style-type: none"> <li>• Noise is mixed.</li> </ul>	<ul style="list-style-type: none"> <li>• The situation may be improved by taking a noise countermeasure such as wiring separation.</li> </ul>

## E042 RTC error

The error is generated if the data of RTC incorporated in the operator keypad is returned to the initial data.



Occurrence ▶	Estimated cause(s) ▶	Exemplar measures to be taken
Error occurred at power-on.	<ul style="list-style-type: none"> <li>• A battery in the operator runs out.</li> </ul>	<ul style="list-style-type: none"> <li>• Replacement of the battery and setting of the date solve the issue. The error occurs when the power supply is turned ON with a dead battery.</li> </ul>

## E043 EzSQ illegal instruction error

This error is output when an invalid instruction is detected in operation of a program which is downloaded to the inverter while the programing function EzSQ is used.

The error is also output if the program is put into action in the condition that the program hasn't been written.



Occurrence ▶	Estimated cause(s) ▶	Exemplar measures to be taken
Error occurred when the program was about to put into action.	<ul style="list-style-type: none"> <li>• Writing error due to noise</li> </ul>	<ul style="list-style-type: none"> <li>• There is a possibility of EzSQ program writing error and if there is a noise source nearby, the situation may be improved by taking a noise countermeasure such as keeping the noise source away and writing the program.</li> </ul>
	<ul style="list-style-type: none"> <li>• Program hasn't been entered.</li> </ul>	<ul style="list-style-type: none"> <li>• EzSQ program needs to be written in the factory default setting condition and after initialization. Write in the program.</li> </ul>



## E044 EzSQ nest count error

This error is output when the nesting frequency of a subroutine, "for" statement, "next" statement, etc. on a program exceeds 8 times while the programming function EzSQ is used.



**E044**

Occurrence ▶	Estimated cause(s) ▶	Exemplar measures to be taken
Error occurred when the program was put into action.	<ul style="list-style-type: none"> <li>Program structure is too complicated.</li> </ul>	<ul style="list-style-type: none"> <li>The program has deep nesting of a subroutine, "for" statement, "next" statement, etc., with its nesting frequency exceeding 8 times. Improvement of the program structure is required.</li> </ul>

## E045 EzSQ executive instruction error

During operation of a program which is downloaded to the inverter while the programming function EzSQ is used, if execution of the program is turned OFF due to an error, the inverter generates E045 error.



**E045**

Occurrence ▶	Estimated cause(s) ▶	Exemplar measures to be taken
Error occurred when the program was put into action.	<ul style="list-style-type: none"> <li>Program flow is inadequate.</li> </ul>	<ul style="list-style-type: none"> <li>This error is output if there is no nest starting statement such as "for" at the point when "goto" statement refers to, or if a nest ending statement such as "next" precedes the nest starting statement. Check the structure of "for" statement and "next" statement and make amendments as needed.</li> </ul>
	<ul style="list-style-type: none"> <li>There is a problem in the data.</li> </ul>	<ul style="list-style-type: none"> <li>There may be an overflow, underflow, or division by zero in four arithmetic operations. Check the result of operations and amend the operations as needed.</li> </ul>
		<ul style="list-style-type: none"> <li>This error is output if a non-existing parameter is referred to or a setting is made beyond the setting range in "chg param" or "mon param" instruction. Check the content of instruction and make amendments as needed.</li> </ul>

## E050 to E059

### EzSQ user-assigned errors 0 to 9

**E050~  
E059**

The inverter generates these errors when the corresponding user-assigned tripping programs are executed during operation of a program which is downloaded to the inverter while the programming function EzSQ is used.

Occurrence ▶	Estimated cause(s) ▶	Exemplar measures to be taken
Error occurred when the program was put into action.	<ul style="list-style-type: none"> <li>The program has an error instruction.</li> </ul>	<ul style="list-style-type: none"> <li>If a user-assigned error occurs unintentionally, check the content of trip instruction of the program and make amendments as needed.</li> </ul>

## E060 to E069

### Option 1 errors 0 to 9

**E060~  
E069**

Errors occurring in an option mounted in the option slot 1 (to the observer's left) are detected.

For details, refer to the instruction manual provided together with the option mounted.

Occurrence ▶	Estimated cause(s) ▶	Exemplar measures to be taken
Error occurred when an option is mounted.	<ul style="list-style-type: none"> <li>The option isn't securely mounted.</li> </ul>	<ul style="list-style-type: none"> <li>The option may not be securely mounted. Check the mounting state.</li> </ul>
	<ul style="list-style-type: none"> <li>The option is used in the wrong way.</li> </ul>	<ul style="list-style-type: none"> <li>The type of error varies depending on options. For details, refer to the instruction manuals provided together with the respective options.</li> </ul>

**E070 to E079****Option 2 errors 0 to 9**

Errors occurring in an option mounted in the option slot 2 (to the observer's center) are detected.

For details, refer to the instruction manual provided together with the option mounted.

**E070~  
E079**

Occurrence ▶	Estimated cause(s) ▶	Exemplar measures to be taken
Error occurred when an option is mounted.	• The option isn't securely mounted.	• The option may not be securely mounted. Check the mounting state.
	• The option is used in the wrong way.	• The type of error varies depending on options. For details, refer to the instruction manuals provided together with the respective options.

**E080 to E089****Option 3 errors 0 to 9**

Errors occurring in an option mounted in the option slot 3 (to the observer's right) are detected.

For details, refer to the instruction manual provided together with the option mounted.

**E080~  
E089**

Occurrence ▶	Estimated cause(s) ▶	Exemplar measures to be taken
Error occurred when an option is mounted.	• The option isn't securely mounted.	• The option may not be securely mounted. Check the mounting state.
	• The option is used in the wrong way.	• The type of error varies depending on options. For details, refer to the instruction manuals provided together with the respective options.

## E090 to E096

### STO path error

### FS option error

E090~  
E096

This error is output when there is a problem in functional safety circuit path.

For details of E090 to E093, refer to the separate-volume "Functional Safety Guide". For details of E094 to E096, refer to the instruction manual provided together with the option P1-FS

Occurrence ▶	Estimated cause(s) ▶	Exemplar measures to be taken
The safety function is used.	<ul style="list-style-type: none"> <li>The safety function system has problems.</li> </ul>	<ul style="list-style-type: none"> <li>Refer to the separate-volume "Functional Safety Guide" and "P1-FS Functional Safety Guide".</li> </ul>

## E100 Encoder

### disconnection error

E100

This is an error related to feedback options.

For E100 (encoder disconnection error), see the P1-FB user's guide.

## E104 Position control range error



When the current position counter exceeds the position control ranges for normal/reverse rotation in the setting of [AE-52] position range (normal) or [AE-54] position range (reverse), the inverter turns OFF its output and displays the error.

Related pages found herein: 12-17-26

Occurrence ▶	Estimated cause(s) ▶	Exemplar measures to be taken
Error occurred during operation.	<ul style="list-style-type: none"> <li>Recheck the setting of electronic gear.</li> </ul>	<ul style="list-style-type: none"> <li>Re-examination of operation condition or correction of load condition may improve the situation.</li> </ul>
	<ul style="list-style-type: none"> <li>A slip occurs due to improper encoder setting.</li> </ul>	<ul style="list-style-type: none"> <li>Check the encoder mounting state. If any, re-examine factors for slipping.</li> </ul>
	<ul style="list-style-type: none"> <li>Improper encoder setting</li> </ul>	<ul style="list-style-type: none"> <li>Check the setting of encoder constant and the like.</li> </ul>
	<ul style="list-style-type: none"> <li>Improper electronic gear setting</li> </ul>	<ul style="list-style-type: none"> <li>Recheck the setting of electronic gear.</li> </ul>

## E105 Speed deviation error



When the deviation between the frequency command and the feedback speed exceeds the [bb-83] speed deviation error detection level setting, the inverter judges it as an error. If "01: Error" is specified for [bb-82] Operation for speed deviation error, the inverter turns ON the output terminal function 041 [DSE] with a speed deviation error, turns OFF the inverter output, and displays this error.

Related pages found herein: 12-16-11

Occurrence ▶	Estimated cause(s) ▶	Exemplar measures to be taken
Error occurred during operation.	<ul style="list-style-type: none"> <li>Recheck the setting of electronic gear.</li> </ul>	<ul style="list-style-type: none"> <li>Re-examination of operation condition or correction of load condition may improve the situation.</li> </ul>
	<ul style="list-style-type: none"> <li>A slip occurs due to improper encoder setting.</li> </ul>	<ul style="list-style-type: none"> <li>Check the encoder mounting state. If any, re-examine factors for slipping.</li> </ul>
	<ul style="list-style-type: none"> <li>Improper encoder setting</li> </ul>	<ul style="list-style-type: none"> <li>Check the setting of encoder constant and the like.</li> </ul>
	<ul style="list-style-type: none"> <li>Improper electronic gear setting</li> </ul>	<ul style="list-style-type: none"> <li>Recheck the setting of electronic gear.</li> </ul>

## E106 Position deviation error

E106

When the [bb-87] abnormal position deviation time passes with the deviation of the position feedback against the position command exceeding the [bb-86] abnormal position deviation detection level, it is determined to be abnormal. When the behavior of the abnormal position deviation [bb-85] has been set to 01, the output terminal [PDD] is turned ON, the output is turned OFF, and the error is displayed.

Related pages found herein: 12-17-18

Occurrence ▶	Estimated cause(s) ▶	Exemplar measures to be taken
Error occurred during operation.	<ul style="list-style-type: none"> <li>• Recheck the setting of electronic gear.</li> </ul>	<ul style="list-style-type: none"> <li>• Re-examination of operation condition or correction of load condition may improve the situation.</li> </ul>
	<ul style="list-style-type: none"> <li>• A slip occurs due to improper encoder setting.</li> </ul>	<ul style="list-style-type: none"> <li>• Check the encoder mounting state. If any, re-examine factors for slipping.</li> </ul>
	<ul style="list-style-type: none"> <li>• Improper encoder setting</li> </ul>	<ul style="list-style-type: none"> <li>• Check the setting of encoder constant and the like.</li> </ul>
	<ul style="list-style-type: none"> <li>• Improper electronic gear setting</li> </ul>	<ul style="list-style-type: none"> <li>• Recheck the setting of electronic gear.</li> </ul>

## E107 Over-speed error

E107

When the speed has exceeded [bb-80] Over-speed error detection level and [bb-81] Over-speed error detection time has elapsed, the output is turned OFF and the error is displayed.

Related pages found herein: 12-16-12

Occurrence ▶	Estimated cause(s) ▶	Exemplar measures to be taken
Error occurred during operation.	<ul style="list-style-type: none"> <li>• Recheck the setting of electronic gear.</li> </ul>	<ul style="list-style-type: none"> <li>• Re-examination of operation condition or correction of load condition may improve the situation.</li> </ul>
	<ul style="list-style-type: none"> <li>• Improper encoder setting</li> </ul>	<ul style="list-style-type: none"> <li>• Check the setting of encoder constant and the like.</li> </ul>
	<ul style="list-style-type: none"> <li>• Improper electronic gear setting</li> </ul>	<ul style="list-style-type: none"> <li>• Recheck the setting of electronic gear.</li> </ul>

## E110 Contactor error

When an error occurs in the contactor sequence, the output is turned OFF.

Related pages found herein: 12-17-10



**E110**

Occurrence ▶	Estimated cause(s) ▶	Exemplar measures to be taken
[COK] was not turned ON within the contactor check time at start-up.	• Wiring defect	• Check the setting and wiring of intelligent input.
	• Contactor response defect	• Check the operation of contactor including its response time.
[COK] was not turned OFF within the contactor check time at stop.	• Wiring defect	• Check the setting and wiring of intelligent input.
	• Contactor response defect	• Check the operation of contactor including its response time.

## E112 Feedback option connection error

This is an error related to feedback options.

For E112 (FB option connection error), see the P1-FB user's guide.



**E112**

### 18.5. Troubleshooting for Warning-function Related Errors

#### 18.5.1 Checking the warning display

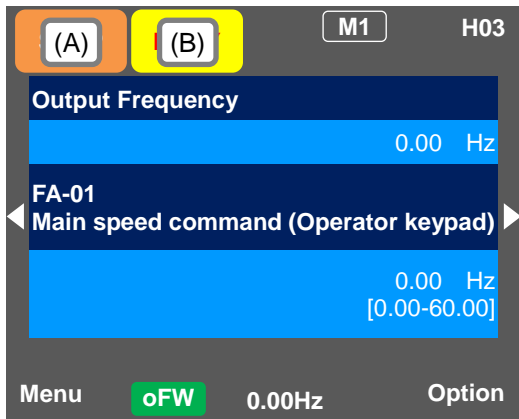

#### Indication (A) Main Operating status display

No.	Indication	Description
A1		Icon shown during normal rotation operation. Some parameters cannot be changed while the inverter is running.
A2		Icon shown during reverse rotation operation. Some parameters cannot be changed while the inverter is running.
A3		Icon shown during outputting under a zero-Hz command. It is also shown while DB, FOC, SON function is working. Some parameters cannot be changed while the inverter is running.
A4		Icon shown when an error occurred and the inverter is in trip state. Releasable errors can be released by a reset operation. ⇒ 18.3.1 Checking trip information
A5		Icon shown when a setting inconsistency exists. Eliminate the inconsistency. ⇒ 18.5.2 Checking setting inconsistencies
A6		Icon shown while the inverter is forced stop by the following functions although operation command is entered. <ul style="list-style-type: none"> <li>An operation command was entered under 0Hz frequency command.</li> <li>Operation command was entered from a source other than the operation keypad and the operation was stopped with STOP key on the operation keypad.</li> <li>The inverter stops by instantaneous power failure non-stop function. RUN lamp flashes during this.</li> </ul>
A7		Inverter is stopped because no operation command is given. The inverter cannot be operated if the stop terminal functions such as [RS] and [FRS] or the STO function is ON.

(Notes)

- When A6: STOP (in red) is indicated...
  - ⇒ If the value shown in the indication (F): frequency command is 0.00Hz, the frequency command is 0Hz. Check whether a frequency command is entered or not.
  - ⇒ For example, if the operation was stopped with STOP key while the inverter had been operated with [FW] terminal, turn OFF the [FW] terminal and then ON again to restart the operation.

#### Indication (B) Warning status display

No.	Indication	Description
B1		Icon shown while the following functions are working. [dC-37] <ul style="list-style-type: none"> <li>Under overload limit.</li> <li>Under torque limit.</li> <li>Under overcurrent suppression.</li> <li>Under overvoltage suppression.</li> <li>Under upper/lower limit operation.</li> <li>Under jump frequency operation.</li> <li>Under minimum frequency limit.</li> </ul>
B2		Icon shown while the following functions are working. [dC-38] <ul style="list-style-type: none"> <li>Overload advance notice</li> <li>Motor thermal advance notice</li> <li>Inverter thermal advance notice</li> <li>Motor overheat advance notice</li> </ul>
B3		Icon shown during retry standby or restart standby. [dC-39]
B4		The inverter cannot be operated even when the operation command is entered. [dC-40] <ul style="list-style-type: none"> <li>The main power is under insufficient voltage supply.</li> <li>The inverter is operating only with 24V power supply.</li> <li>Under reset operation.</li> <li>The inverter is OFF as the [REN] terminal function is enabled.</li> </ul>
B5		Icon shown in fan life advance notice state.
B6		Icon shown in on-board capacitor life advance notice state.
B7		Icon shown in fan life advance notice and on-board capacitor life advance notice state.
B8	(None)	A state other than those above.

(Notes)

- B1:LIM and B2:ALT are indicated when the current or internal voltage has increased. If an error is generated, re-examination of load or other factors is required.
- The above-mentioned indications are shown when the cooling fan or capacitor on the board is determined to have reached its product life.
- **You can see the detailed warning by pressing UP key on the three-lined monitor screen.**



■ (STOP in red) appears.



• (STOP in red) appears.



• See below.

Occurrence ▶	Estimated cause(s) ▶	Exemplar measures to be taken
<p>RUN key on the keypad was pressed.</p> <p>[FW] terminal was turned ON.</p> <p>Operation command was entered.</p>	<p>If LIM icon is lit, the command is below the minimum frequency and the following reasons are conceivable.</p> <ul style="list-style-type: none"> <li>• Operation command is entered but not frequency command.</li> <li>• Frequency command destination selection is wrong.</li> </ul>	<ul style="list-style-type: none"> <li>• Check that [FA-01] main speed command is not set to 0.00Hz.</li> <li>• Check whether the command is entered from the command destination indicated on the right of the main speed command [FA-01].</li> <li>• Check [AA101] main speed command destination.</li> </ul>
<p>After STOP key on keypad is pressed, inverter doesn't operate with RUN key.</p>	<ul style="list-style-type: none"> <li>• STOP key on the operation keypad was pressed when the operation command had been entered from a source other than the operation keypad.</li> </ul>	<ul style="list-style-type: none"> <li>• Cancel the command entered to the operation command destination.</li> </ul>
<p>Instantaneous power failure occurred.</p>	<ul style="list-style-type: none"> <li>• The inverter stopped by the instantaneous power failure non-stop function [bA-30].</li> </ul>	<ul style="list-style-type: none"> <li>• To start operation, turn off the command entered to the operation command destination and turn on again.</li> </ul>

■ (WARN) appears.



• (WARN) appears.



• See below.

Occurrence ▶	Estimated cause(s) ▶	Exemplar measures to be taken
<p>A setting was configured.</p>	<ul style="list-style-type: none"> <li>• There is an inconsistency in the parameter setting</li> </ul>	<ul style="list-style-type: none"> <li>• Refer to 18.5.2 "Checking setting inconsistencies".</li> </ul>

Icon 2 LIM monitor



- The LIM icon is shown on the display.



- When LIM is shown, the inverter is in the following condition(s).
- You can see the status of LIM by pressing UP key on the three-lined monitor or on [dC-37].

Occurrence ▶	Estimated cause(s) ▶	Exemplar measures to be taken
Output current was high, and [dC-37] LIM was set to 01.	<ul style="list-style-type: none"> <li>[bA120] overcurrent suppression function was enabled and the current increased due to the load or other factors.</li> </ul>	<ul style="list-style-type: none"> <li>Remove the factor for the increased load. (E.g., by cleaning a clogged channel, re-examining the load)</li> </ul>
	<ul style="list-style-type: none"> <li>The current was increased by the high ratio of motor rotation during DC braking that was caused by the selection of [DB] terminal or [AF101] DC braking.</li> </ul>	<ul style="list-style-type: none"> <li>Reduce the DC braking force in [AF105] or [AF108].</li> <li>For stopping, set longer time for [AF106] DC braking delay time at the time of the stop.</li> <li>For retry operation at the start, set longer delay time according to the factors. [bb-26] [bb-29] [bb-31]</li> </ul>
Output current was high, and [dC-37] LIM was set to 02.	<ul style="list-style-type: none"> <li>[FA-10] acceleration time is too short.</li> </ul>	<ul style="list-style-type: none"> <li>Make the acceleration time longer in [FA-10].</li> </ul>
	<ul style="list-style-type: none"> <li>[bA122] overload limit function or similar function was enabled and the current increased due to the load or other factors.</li> <li>[bA122] overload limit function or similar function was enabled and [FA-10] acceleration time was too short.</li> </ul>	<ul style="list-style-type: none"> <li>Remove the factor for the increased load. (E.g., by cleaning a clogged channel, re-examining the load)</li> <li>Make the acceleration time longer in [FA-10].</li> </ul>
Error occurred during deceleration. [dC-37] LIM was set to 03.	<ul style="list-style-type: none"> <li>[bA140] overvoltage suppression function was enabled and P-N voltage increased due to regenerative load or the like.</li> </ul>	<ul style="list-style-type: none"> <li>Remove the factor for the increased regenerative load. (E.g., by re-examining the state of the motor being rotated by external force, and by re-examining the load)</li> </ul>
	<ul style="list-style-type: none"> <li>[bA122] overload limit function or similar function was enabled and [FA-12] deceleration time was too short.</li> </ul>	<ul style="list-style-type: none"> <li>Make the deceleration time longer in [FA-12].</li> </ul>
Error occurred during sudden acceleration. [dC-37] LIM was set to 03.	<ul style="list-style-type: none"> <li>[bA140] overvoltage suppression function was enabled and P-N voltage increased due to regenerative load or the like.</li> </ul>	<ul style="list-style-type: none"> <li>Remove the factor for the increased regenerative load. (E.g., by re-examining the state of the motor being rotated by external force, and by re-examining the load)</li> </ul>
Output current was high, and [dC-37] LIM was set to 04.	<ul style="list-style-type: none"> <li>[bA110] torque limit function or similar function was enabled and the current increased due to the load or other factors.</li> </ul>	<ul style="list-style-type: none"> <li>Remove the factor for the increased load. (E.g., by cleaning a clogged channel, re-examining the load)</li> </ul>
	<ul style="list-style-type: none"> <li>[bA110] torque limit function or similar function was enabled and [FA-10] acceleration time was too short.</li> </ul>	<ul style="list-style-type: none"> <li>Make the acceleration time longer in [FA-10].</li> </ul>
Error occurred during operation. [dC-37] LIM was set to 05.	<ul style="list-style-type: none"> <li>The normal limiting was performed according to the settings of [bA102] upper limiter, [bA103] lower limiter, and [AG101] and other jump frequencies.</li> </ul>	<ul style="list-style-type: none"> <li>Re-examine the settings of the upper/lower limiter or jump frequencies if necessary.</li> </ul>
Error occurred during operation. [dC-37] LIM was set to 06.	<ul style="list-style-type: none"> <li>The frequency command at below the minimum frequency [Hb130] has been input.</li> </ul>	<ul style="list-style-type: none"> <li>Set the frequency command at the minimum frequency or higher in [FA-01].</li> </ul>

■ Icon 2 ALT monitor



- The ALT icon is shown on the display.



- When ALT is shown, the inverter is in the following condition(s).
- You can see the status of ALT by pressing UP key on the three-lined monitor or on [dC-38].

Occurrence ▶	Estimated cause(s) ▶	Exemplar measures to be taken
Output current was high, and [dC-38] ALT was set to 01.	<ul style="list-style-type: none"> <li>• The current increased due to load or other factors, exceeding the overload prewarning levels set in [CE106] or the similar parameter.</li> </ul>	<ul style="list-style-type: none"> <li>• Remove the factor for the increased load. (E.g., by cleaning a clogged channel)</li> <li>• Enable [bA122] overload limit function or similar function.</li> </ul>
Output current was high, and [dC-38] ALT was set to 02.	<ul style="list-style-type: none"> <li>• The electronic thermal function of motor was activated due to increase in current and the load exceeded the electronic thermal warning level (MTR) set in [CE-30].</li> </ul>	<ul style="list-style-type: none"> <li>• Remove the factor for the increased load. (E.g., by cleaning a clogged channel)</li> <li>• Re-examine the electric thermal settings in [bC110] or the similar parameter.</li> </ul>
Output current was high, and [dC-38] ALT was set to 03.	<ul style="list-style-type: none"> <li>• The electronic thermal function of inverter was activated due to increase in current and the load exceeded the electronic thermal warning level (CTL) set in [CE-31].</li> </ul>	<ul style="list-style-type: none"> <li>• Remove the factor for the increased load. (E.g., by cleaning a clogged channel)</li> </ul>

■ Icon 2 RETRY monitor



- The RETRY icon is shown on the display.



- When RETRY is shown, the inverter is in the following condition(s).
- You can see the status of RETRY by pressing UP key on the three-lined monitor or on [dC-39].

Occurrence ▶	Estimated cause(s) ▶	Exemplar measures to be taken
Output was turned OFF and [dC-39] RETRY was set to 01.	<ul style="list-style-type: none"> <li>• The inverter is in the waiting mode after a trip retry operation due to increased current or P-N voltage fluctuation.</li> </ul>	<ul style="list-style-type: none"> <li>• If the wait time become longer, the following delay time become shorter. [bb-26] [bb-29] [bb-31]</li> <li>• If this error is generated consecutively, make the wait time longer. [bb-26] [bb-29] [bb-31]</li> </ul>
Output was turned OFF and [dC-39] RETRY was set to 02.	<ul style="list-style-type: none"> <li>• The inverter is in the waiting mode before restart after power-off by [RS], [FRS], or [CS] terminal.</li> </ul>	<ul style="list-style-type: none"> <li>• If the wait time become longer, the following delay time become shorter. [bb-26]</li> </ul>

Icon 2 NRDY monitor



- The NRDY icon is shown on the display.



- When NRDY is shown, the inverter is in the following condition(s).
- You can see the status of NRDY by pressing UP key on the three-lined monitor or on [dC-40].

Occurrence ▶	Estimated cause(s) ▶	Exemplar measures to be taken
TRIP display was shown and [dC-40] NRDY was set to 01.	<ul style="list-style-type: none"> <li>• There was an error factor, which caused the inverter to trip.</li> </ul>	<ul style="list-style-type: none"> <li>• Remove the error factor. Consult this chapter.</li> </ul>
The CTRL icon was shown and [dC-40] NRDY was set to 02.	<ul style="list-style-type: none"> <li>• The control power supply (R0, T0) has been input, whereas the main circuit power supply R-S-T hasn't been input.</li> </ul>	<ul style="list-style-type: none"> <li>• Check the input of main circuit power supply and examine the breaker, wiring, and so on.</li> </ul>
The 24V icon was shown and [dC-40] NRDY was set to 02.	<ul style="list-style-type: none"> <li>• Only 24V has been input to the backup power supply P+-P-.</li> </ul>	<ul style="list-style-type: none"> <li>• Check the input of main circuit power supply and the control power supply, and examine the breaker, wiring, and so on.</li> </ul>
[dC-40] NRDY was set to 03.	<ul style="list-style-type: none"> <li>• [RS] terminal is ON and the inverter is under reset operation.</li> </ul>	<ul style="list-style-type: none"> <li>• Check the wiring and operation state of [RS] terminal.</li> </ul>
[dC-40] NRDY was set to 04.	<ul style="list-style-type: none"> <li>• The STO circuit is turned OFF or broken.</li> </ul>	<ul style="list-style-type: none"> <li>• Check ST1/ST2 terminals.</li> </ul>
[dC-40] NRDY was set to 05.	<ul style="list-style-type: none"> <li>• The inverter is checking the internal circuit, operator keypad, options, etc.</li> </ul>	<ul style="list-style-type: none"> <li>• If this error is not released, check the operator keypad for contact failure or other problem.</li> </ul>
[dC-40] NRDY was set to 06.	<ul style="list-style-type: none"> <li>• There is an inconsistency in the setting</li> </ul>	<ul style="list-style-type: none"> <li>• Although [AA121] is set to 10 (Vector control with sensor), the option P1-FB is not attached.</li> <li>• Refer to 18.5.2 "Checking setting inconsistencies".</li> </ul>
[dC-40] NRDY was set to 07.	<ul style="list-style-type: none"> <li>• There is a sequence operation problem in the brake control.</li> </ul>	<ul style="list-style-type: none"> <li>• Check the setting and signal operation of [AF130] brake control or the similar parameter.</li> </ul>
[dC-40] NRDY was set to 08.	<ul style="list-style-type: none"> <li>• [FRS] terminal or [CS] terminal was turned ON.</li> <li>• [FRS] or [CS] command was entered from the communication.</li> </ul>	<ul style="list-style-type: none"> <li>• Check the signal operation of input terminal for [FRS] or [CS].</li> </ul>
[dC-40] NRDY was set to 09.	<ul style="list-style-type: none"> <li>• Operation command isn't permitted.</li> <li>• Forced stop is being issued. (Deceleration stop behavior)</li> </ul>	<ul style="list-style-type: none"> <li>• The [REN] terminal has been assigned and is turned OFF.</li> <li>• STOP key was pressed when commands had been entered from a source other than the operation keypad.</li> </ul>

## 18.5.2 Checking setting inconsistencies



- A warning was generated. You want to identify the cause and troubleshoot the warning.



- You need to take a measure according to the warning number and the type of warning. Refer to the table below.
- The induction motor (IM) control and synchronous motor (permanent magnetic motor) (SM (PMM)) control can be switched in [AA121].

Occurrence ▶	Estimated cause(s) ▶	Exemplar measures to be taken
Warning was generated - 102	(First Max. frequency) < (first upper limiter) IM: [Hb105] < [bA102] SM (PMM): [Hd105] < [bA102]	<ul style="list-style-type: none"> <li>• Increase the Max. frequency [Hb105]/[Hd105].</li> <li>• Decrease the upper limiter [bA102].</li> </ul>
Warning was generated - 103	(First Max. frequency) < (first lower limiter) IM: [Hb105] < [bA103] SM (PMM): [Hd105] < [bA103]	<ul style="list-style-type: none"> <li>• Increase the Max. frequency [Hb105]/[Hd105].</li> <li>• Decrease the lower limiter [bA103].</li> </ul>
Warning was generated - 106	(First Max. frequency) < (first main speed command) IM: [Hb105] < [Ab110] SM (PMM): [Hd105] < [Ab110]	<ul style="list-style-type: none"> <li>• Increase the Max. frequency [Hb105]/[Hd105].</li> <li>• Decrease the main speed command [Ab110].</li> </ul>
Warning was generated - 107	(First Max. frequency) < (first auxiliary speed command) IM: [Hb105] < [AA104] SM (PMM): [Hd105] < [AA104]	<ul style="list-style-type: none"> <li>• Increase the Max. frequency [Hb105]/[Hd105].</li> <li>• Decrease the auxiliary speed command [AA104].</li> </ul>
Warning was generated - 202	(Second Max. frequency) < (second upper limiter) IM: [Hb205] < [bA202] SM (PMM): [Hd205] < [bA202]	<ul style="list-style-type: none"> <li>• Increase the Max. frequency [Hb205]/[Hd205].</li> <li>• Decrease the upper limiter [bA202].</li> </ul>
Warning was generated - 203	(Second Max. frequency) < (second lower limiter) IM: [Hb205] < [bA203] SM (PMM): [Hd205] < [bA203]	<ul style="list-style-type: none"> <li>• Increase the Max. frequency [Hb105]/[Hd105].</li> <li>• Decrease the lower limiter [bA103].</li> </ul>
Warning was generated - 206	(Second Max. frequency) < (second main speed command) IM: [Hb205] < [Ab210] SM (PMM): [Hd205] < [Ab210]	<ul style="list-style-type: none"> <li>• Increase the Max. frequency [Hb205]/[Hd205].</li> <li>• Decrease the main speed command [Ab210].</li> </ul>
Warning was generated - 207	(Second Max. frequency) < (second auxiliary speed command) IM: [Hb205] < [AA204] SM (PMM): [Hd205] < [AA204]	<ul style="list-style-type: none"> <li>• Increase the Max. frequency [Hb205]/[Hd205].</li> <li>• Decrease the auxiliary speed command [AA204].</li> </ul>

18.5.3 Checking display messages



- A message was appeared on the operator keypad VOP. You want to know the meaning of error.



- A message appears in an event like communication error, insufficient voltage, or result of auto-tuning.
- Even when there is an error, you can exit the error screen with the XX key; however, you still need to remove the error factor separately.

Message▶	Estimated cause(s)▶	Exemplar measures to be taken
Warning xxxxxxxxxxxxxx Press the XX key.	<ul style="list-style-type: none"> <li>• Warning of setting inconsistency was generated. There is inconsistency of setting shown in the warning message.</li> </ul>	<ul style="list-style-type: none"> <li>• The warning will be canceled by amending the indicated parameter setting.</li> </ul>
Auto-tuning (non-revolving) completed. xxxxxxxxxxxxxx Press the XX key.	<ul style="list-style-type: none"> <li>• Non-revolving auto-tuning process is finished.</li> </ul>	<ul style="list-style-type: none"> <li>• See "12.3.3 Auto-tuning of motor".</li> </ul>
Auto-tuning (revolving) completed. xxxxxxxxxxxxxx Press the XX key.	<ul style="list-style-type: none"> <li>• Revolving auto-tuning process is finished.</li> </ul>	<ul style="list-style-type: none"> <li>• See "12.3.3 Auto-tuning of motor".</li> </ul>
Auto-tuning failed. Re-examine the setting and wiring. Press the XX key.	<ul style="list-style-type: none"> <li>• Revolving auto-tuning process is disturbed and not finished.</li> </ul>	<ul style="list-style-type: none"> <li>• See "12.3.3 Auto-tuning of motor" for troubleshooting.</li> </ul>
Initializing... Please wait.	<ul style="list-style-type: none"> <li>• The inverter is being initialized.</li> </ul>	<ul style="list-style-type: none"> <li>• The initialization completion screen will appear after a while.</li> </ul>
Clearing history... Please wait.	<ul style="list-style-type: none"> <li>• The inverter is being initialized.</li> </ul>	<ul style="list-style-type: none"> <li>• The history clearance completion screen will appear after a while.</li> </ul>
Initialization completed !! Target:#:xxxxxxxxxx Selection of initial values (Ub-02) xxxxxxxxxxxxxx Load type selection Ub-03 xxxxxxxxxxxxxx Press the XX key.	<ul style="list-style-type: none"> <li>• The initialization is completed.</li> </ul>	<ul style="list-style-type: none"> <li>• Press XX key to exit the initialization completion screen.</li> </ul>
History clearance completed !! Trip history cleared. Press the XX key.	<ul style="list-style-type: none"> <li>• The history clearance is completed.</li> </ul>	<ul style="list-style-type: none"> <li>• Press XX key to exit the history clearance completion screen.</li> </ul>

Message ▶	Estimated cause(s) ▶	Exemplar measures to be taken
<p>Operation command is limited. Please check operation command.</p>	<ul style="list-style-type: none"> <li>• Operation command of command direction is limited by the setting of [AA114] operation direction limit.</li> <li>• The rotation direction is reversed from the command direction limited according to the setting of [AA114] operation direction limit because the frequency command is turned negative due to calculation of main speed or auxiliary speed.</li> </ul>	<ul style="list-style-type: none"> <li>• Check the setting of [AA114] operation direction limit.</li> <li>• Check the terminal command FW/RW and the command direction of communication command.</li> <li>• Check whether the calculated frequency command is negative or not.</li> </ul>
<p>Resetting. Inverter is being reset. Press the XX key.</p>	<ul style="list-style-type: none"> <li>• [RS] terminal is ON.</li> <li>• Trip reset was performed. (The screen is transited automatically at trip reset.)</li> </ul>	<ul style="list-style-type: none"> <li>• The inverter is in the condition that [RS] terminal is ON. Re-examine the state of input terminal.</li> </ul>
<p>Retrying. Retrying and restarting. Press the XX key.</p>	<ul style="list-style-type: none"> <li>• The inverter is waiting for restart. (This mode is released after the set wait time has elapsed.)</li> <li>• The inverter may not start if the incoming voltage is low.</li> </ul>	<ul style="list-style-type: none"> <li>• If the wait time for restart is long, the message will continue to be indicated. See "12.14 Changing the Start Mode".</li> <li>• If the incoming voltage is low, check the input voltage.</li> </ul>
<p>Main circuit under instantaneous power failure. Power of main circuit is turned OFF. Press the XX key.</p>	<ul style="list-style-type: none"> <li>• The main circuit power supply (R, S, T) is turned OFF due to lightning strikes, power supply environment, or other factors.</li> </ul>	<ul style="list-style-type: none"> <li>• Check the state of input power supply.</li> <li>• The inverter will recover when the power supply returns.</li> </ul>
<p>Main circuit under insufficient voltage. Please check the main circuit power. Press the XX key.</p>	<ul style="list-style-type: none"> <li>• The control circuit power supply (R0, T0) has been input, whereas the main circuit power supply (R, S, T) has been cut.</li> </ul>	<ul style="list-style-type: none"> <li>• Check the state of input power supply.</li> <li>• The inverter will recover when the power supply of main circuit returns.</li> </ul>
<p>POWER OFF POWER OFF Press the XX key.</p>	<ul style="list-style-type: none"> <li>• The power supply to the inverter is turned OFF.</li> </ul>	<ul style="list-style-type: none"> <li>• Check the state of input power supply.</li> <li>• The inverter will recover when the power supply returns.</li> </ul>
<p>Control power under insufficient voltage. Please check the control power supply. Press the XX key.</p>	<ul style="list-style-type: none"> <li>• The control circuit power supply (R0, T0) is turned OFF.</li> </ul>	<ul style="list-style-type: none"> <li>• Check the state of input power supply.</li> <li>• The inverter will recover when the power supply of control circuit returns.</li> </ul>

Message ▶	Estimated cause(s) ▶	Exemplar measures to be taken
Power feeding by external 24Vdc. Only external 24Vdc is feeding power. Press the XX key.	<ul style="list-style-type: none"> <li>The inverter is operating only with 24V power supply input to P+ and P- terminals.</li> </ul>	<ul style="list-style-type: none"> <li>If the input power supply is input, check its state.</li> </ul>
Changing load type... Please wait.	<ul style="list-style-type: none"> <li>The load type of inverter is being changed.</li> </ul>	<ul style="list-style-type: none"> <li>The load type change completion screen will appear after a while.</li> </ul>
Load type change completion !! Load type selection Ub-03  Rated current value changed. Check current-related parameters. Press the XX key.	<ul style="list-style-type: none"> <li>The load type change is completed.</li> </ul>	<ul style="list-style-type: none"> <li>Press XX key to exit the load type change completion screen.</li> </ul>



18.6 When Something Seems Wrong

**Q**

- There is something wrong.
- The inverter doesn't work as intended.
- You are stuck although no error appears in the inverter.

**A**

- Frequently asked questions are listed below.
- Consult this chapter to solve your problem.
- If the problem still persists, please use the contact information shown on the back cover.

Occurrence ▶	Estimated cause(s) ▶	Exemplar measures to be taken
<p><b>S1: Operator keypad doesn't turn ON (the POWER lamp on the operator keypad VOP is not lit.)</b></p>	<ul style="list-style-type: none"> <li>• The power supply is not turned ON.</li> </ul>	<ul style="list-style-type: none"> <li>• Check that the power supply which satisfies the specification is turned ON.</li> <li>• When different powers are supplied to the control power supplies R0 and T0, and to P+ and P- terminals, check that R0, T0, or 24V power supply is turned ON.</li> </ul>
	<ul style="list-style-type: none"> <li>• Operator keypad is about to come off.</li> </ul>	<ul style="list-style-type: none"> <li>• The issue will be solved by remounting the operator keypad.</li> </ul>
	<ul style="list-style-type: none"> <li>• The J51 connector is disconnected.</li> </ul>	<ul style="list-style-type: none"> <li>• The J51 connector supplies power to the control power supplies R0 and T0 from the main power supplies R, S, and T. Keep the connector connected if you do not supply power to the control power supply with a different system.</li> </ul>
	<ul style="list-style-type: none"> <li>• The power supply input path is disconnected.</li> <li>• 200V power is supplied to R0 and T0 for 400V class.</li> </ul>	<ul style="list-style-type: none"> <li>• The breaker or wires may be disconnected. You need to re-examine the wiring.</li> <li>• When different power is supplied to the control power supplies R0 and T0, you also need to re-examine R0 and T0.</li> </ul>
<p><b>S2: Operator keypad doesn't turn ON (the POWER lamp on the operator keypad VOP is lit.)</b></p>	<ul style="list-style-type: none"> <li>• Operator keypad is in the automatic extinction mode.</li> </ul>	<ul style="list-style-type: none"> <li>• The screen is lit by pressing a key on the operator keypad.</li> <li>• The automatic extinction function can be disabled in the operator keypad system setting.</li> </ul>
	<ul style="list-style-type: none"> <li>• The brightness of operator keypad display is set to low.</li> </ul>	<ul style="list-style-type: none"> <li>• The brightness of the display is adjustable by changing the light control setting in the operator keypad system setting.</li> </ul>
	<ul style="list-style-type: none"> <li>• Operator keypad is about to come off.</li> </ul>	<ul style="list-style-type: none"> <li>• The issue will be solved by remounting the operator keypad. (Check the RJ45 connector.)</li> </ul>
	<ul style="list-style-type: none"> <li>• The liquid crystal has reached the end of its life.</li> </ul>	<ul style="list-style-type: none"> <li>• Replacement of the operator keypad is required.</li> </ul>

\* Also, see “18.5.1 Checking the warning display”.

Occurrence ▶	Estimated cause(s) ▶	Exemplar measures to be taken
<p><b>S3: The motor doesn't rotate although an operation command was entered.</b></p>	<ul style="list-style-type: none"> <li>• The inverter is tripping.</li> </ul>	<ul style="list-style-type: none"> <li>• When the inverter trips due to an error, you need to remove the error factor and reset the inverter.</li> <li>• See “18.5. Troubleshooting for Protection-function Related Errors” in this chapter.</li> </ul>
	<ul style="list-style-type: none"> <li>• A warning is issued.</li> </ul>	<ul style="list-style-type: none"> <li>• If a warning is issued, you need to eliminate the data inconsistency.</li> <li>• See “18.4. Troubleshooting for Warning-function Related Errors” in this chapter.</li> </ul>
	<ul style="list-style-type: none"> <li>• The operation command isn't entered.</li> </ul>	<ul style="list-style-type: none"> <li>• The operation command destination may be wrong, or the operation command may not be accepted. ⇒ Proceed to S4.</li> </ul>
	<ul style="list-style-type: none"> <li>• The frequency command destination isn't entered.</li> </ul>	<ul style="list-style-type: none"> <li>• The frequency command destination may be wrong, or the frequency command may be 0. ⇒ Proceed to S5.</li> </ul>
	<ul style="list-style-type: none"> <li>• A shutoff function is at work.</li> </ul>	<ul style="list-style-type: none"> <li>• The function safety terminal, terminal function [RS], or [FRS] terminal may be enabled, or [ROK] terminal may be disabled. ⇒ Proceed to S6.</li> </ul>
	<ul style="list-style-type: none"> <li>• A limit function is at work.</li> </ul>	<ul style="list-style-type: none"> <li>• The command direction may be limited by the rotation direction limit function. ⇒ Proceed to S7.</li> </ul>
	<ul style="list-style-type: none"> <li>• Motor is locked.</li> </ul>	<ul style="list-style-type: none"> <li>• If the motor shaft is locked by something which hinders the brake or the motor revolution (e.g., clogging), the cause needs to be removed.</li> </ul>
	<ul style="list-style-type: none"> <li>• Wiring or the like is disconnected.</li> </ul>	<ul style="list-style-type: none"> <li>• Check for abnormalities such as disconnection of the output line to the motor or disconnection within the motor.</li> </ul>

Occurrence ▶	Estimated cause(s) ▶	Exemplar measures to be taken
<p><b>S4: Operation command destination or operation command is wrong.</b></p>	<ul style="list-style-type: none"> <li>• Even though the operation command is entered, the motor does not drive.</li> </ul>	<ul style="list-style-type: none"> <li>• If the LED for RUN on the operator keypad is lit or the operation display appears, the operation command has been entered normally. There is another factor for why the motor is not driven. ⇒ Return to S3.</li> </ul>
	<ul style="list-style-type: none"> <li>• The operation command destination and the operation command input are not the same.</li> </ul>	<ul style="list-style-type: none"> <li>• Check the operation command destination. Check [AA111] and the terminal function. See "12.5 Select a operation command." for details.</li> </ul>
	<ul style="list-style-type: none"> <li>• You want to make operation from the operator keypad but had made the different setting.</li> </ul>	<ul style="list-style-type: none"> <li>• Confirm that "oFW" or "oRV" is shown on the operator keypad. If it is not shown, then confirm that the operation command selection [AA111] is set to 02 RUN key on operator keypad. If it is shown, the terminal function needs to be checked.</li> </ul>
	<ul style="list-style-type: none"> <li>• You want to make operation from the [FW] terminal but had made the different setting.</li> </ul>	<ul style="list-style-type: none"> <li>• Set the operation command selection [AA111] to 00 [FW/RV] terminal. If RUN is not shown when the [FW] terminal is turned ON, other terminal functions need to be checked.</li> </ul>
	<ul style="list-style-type: none"> <li>• There is a cause other than the operation command.</li> </ul>	<ul style="list-style-type: none"> <li>• If the operator keypad doesn't show RUN, a shutoff function or the main power supply may not be turned ON.</li> <li>• There is another factor for why the motor is not driven. ⇒ Return to S3.</li> </ul>

Occurrence▶	Estimated cause(s)▶	Exemplar measures to be taken
<p><b>S5: Frequency command destination or frequency command is wrong.</b></p>	<ul style="list-style-type: none"> <li>• Frequency command is 0.</li> <li>• [dA-04] has been 0.</li> </ul>	<ul style="list-style-type: none"> <li>• The frequency command destination may be wrong, or the setting of the command destination or the input voltage of frequency setter may be 0. Set the value other than 0 for the setting destination.</li> </ul>
	<ul style="list-style-type: none"> <li>• Frequency command destination is wrong.</li> </ul>	<ul style="list-style-type: none"> <li>• Check the frequency command destination. Check [AA101] and the terminal function. See “12.4 Select a frequency command.” for details.</li> </ul>
	<ul style="list-style-type: none"> <li>• You want to set the frequency command but [FA-01] has been 0.</li> </ul>	<ul style="list-style-type: none"> <li>• Set the operation command selection [AA101] to 02: Key on operator keypad, and then change the setting of [Ab110].</li> </ul>
	<ul style="list-style-type: none"> <li>• [FA-01] has been 0 even though the frequency setter is operated.</li> </ul>	<ul style="list-style-type: none"> <li>• Connect the main speed selection [AA101] according to the analog input to be used, and operate the frequency setter.</li> </ul>
	<ul style="list-style-type: none"> <li>• [FA-01] is not 0, and there is a cause other than the frequency command.</li> </ul>	<ul style="list-style-type: none"> <li>• If data appears in [FA-01], the frequency command is normal.</li> <li>• There is another factor for why the motor is not driven. ⇒ Return to S3.</li> </ul>

Occurrence▶	Estimated cause(s)▶	Exemplar measures to be taken
<p><b>S6: A shutoff function is at work.</b></p>	<ul style="list-style-type: none"> <li>The main power supply is not turned ON.</li> </ul>	<ul style="list-style-type: none"> <li>When the power supply is separated to R, S, T and R0, T0 (J51 connector section), the inverter can not be operated if the R, S, T, side power is down. The power supply check is required.</li> </ul>
	<ul style="list-style-type: none"> <li>[RS] terminal is ON.</li> </ul>	<ul style="list-style-type: none"> <li>If the [RS] terminal is ON, the inverter enters the reset mode and does not accept operation commands. The [RS] terminal needs to be turned OFF.</li> </ul>
	<ul style="list-style-type: none"> <li>[FRS] terminal is ON.</li> </ul>	<ul style="list-style-type: none"> <li>If the [FRS] terminal is ON, the inverter enters the free-run stop mode and does not accept operation commands. The [FRS] terminal needs to be turned OFF.</li> </ul>
	<ul style="list-style-type: none"> <li>[CS] terminal is ON.</li> </ul>	<ul style="list-style-type: none"> <li>If the [CS] terminal is ON, the inverter enters the mode switched to commercial power supply shutoff and does not accept operation commands. Check the commercial</li> </ul>
	<ul style="list-style-type: none"> <li>The [ROK] terminal has been assigned and is turned OFF.</li> </ul>	<ul style="list-style-type: none"> <li>When the [ROK] terminal is used, if the terminal function is OFF, the inverter does not accept operation commands. Check the operation permission signal.</li> </ul>
	<ul style="list-style-type: none"> <li>STO terminal is not wired or is in OFF state.</li> </ul>	<ul style="list-style-type: none"> <li>If you do not use the function of STO terminal, you need to attach a short-circuit wire to it.</li> </ul>
	<ul style="list-style-type: none"> <li>The inverter is tripping.</li> </ul>	<ul style="list-style-type: none"> <li>When the inverter is tripping, it does not accept operation commands. Identify the factors for trip.</li> </ul>
	<ul style="list-style-type: none"> <li>Shutoff functions are not on.</li> </ul>	<ul style="list-style-type: none"> <li>If shutoff functions are not on and the motor is not driven, there is another factor. ⇒ Return to S3.</li> </ul>

Occurrence ▶	Estimated cause(s) ▶	Exemplar measures to be taken
<p><b>S7: A limit function is at work.</b></p>	<ul style="list-style-type: none"> <li>The operation permission signal has been assigned to the input terminal function and the signal is turned OFF.</li> </ul>	<ul style="list-style-type: none"> <li>When the operation permission signal has been assigned, the operation permission signal needs to be turned ON.</li> </ul>
	<ul style="list-style-type: none"> <li>The command is given to the direction the operation is limited.</li> </ul>	<ul style="list-style-type: none"> <li>Check the operation command direction limit.</li> </ul>
	<ul style="list-style-type: none"> <li>Both [FW] terminal and [RV] terminals are turned ON by operation command from input terminal.</li> </ul>	<ul style="list-style-type: none"> <li>If both [FW] terminal and [RV] terminal are turned ON, input inconsistency is generated and the inverter stops. Use only either one of them to operate the inverter.</li> </ul>

Occurrence ▶	Estimated cause(s) ▶	Exemplar measures to be taken
<p><b>S8: Motor speed doesn't rise.</b></p>	<ul style="list-style-type: none"> <li>The overload limit function is at work.</li> </ul>	<ul style="list-style-type: none"> <li>The overload limit function suppresses the current by dropping the frequency when the output current exceeds the overload limit level.</li> <li>Raising the setting level may improve the situation.</li> </ul>
	<ul style="list-style-type: none"> <li>The frequency command is limited.</li> </ul>	<ul style="list-style-type: none"> <li>If the upper limiter and the maximum frequency is set to low level, the situation will be improved by setting them to higher level. To limit frequencies, use the upper limiter function instead of the maximum frequency.</li> </ul>
	<ul style="list-style-type: none"> <li>The frequency command is low.</li> </ul>	<ul style="list-style-type: none"> <li>The command becomes lower when a more prioritized frequency command such as for jogging or multi-speed command is entered. Re-examination of the terminal function and frequency command destination are required.</li> </ul>
	<ul style="list-style-type: none"> <li>Acceleration time is long.</li> </ul>	<ul style="list-style-type: none"> <li>If the acceleration time is set long, acceleration becomes slow. Set the acceleration time short.</li> </ul>

Occurrence▶	Estimated cause(s)▶	Exemplar measures to be taken
<p><b>S9: The parameter you are looking for is not shown.</b></p>	<ul style="list-style-type: none"> <li>The display limit has been set.</li> </ul>	<ul style="list-style-type: none"> <li>Display limit function may be working. Cancel the display limit selection [UA-10].</li> </ul>
	<ul style="list-style-type: none"> <li>The display is fixed.</li> </ul>	<ul style="list-style-type: none"> <li>Operation on the operator keypad isn't accepted if the input terminal function 102 [DISP] is ON. Turn OFF the terminal.</li> </ul>
<p><b>S10: Keypad operator cannot be operated.</b></p>	<ul style="list-style-type: none"> <li>The display is fixed.</li> </ul>	<ul style="list-style-type: none"> <li>Operation on the operator keypad isn't accepted if the input terminal function 102 [DISP] is ON. Turn OFF the terminal.</li> </ul>
<p><b>S11: Setting cannot be made.</b></p>	<ul style="list-style-type: none"> <li>Inverter is running.</li> </ul>	<ul style="list-style-type: none"> <li>Some parameters cannot be changed while the inverter is running. If that is the case, turn OFF the inverter once.</li> </ul>
<p><b>S12: Motor rotates in a reverse direction.</b></p>	<ul style="list-style-type: none"> <li>The wires connected to the motor are in wrong phase sequence.</li> </ul>	<ul style="list-style-type: none"> <li>Swapping two phases of wires connected to the motor changes the direction of rotation.</li> </ul>
	<ul style="list-style-type: none"> <li>When the RUN key on the operator keypad is used, the rotation direction setting is wrong.</li> </ul>	<ul style="list-style-type: none"> <li>[AA-12] RUN key direction needs to be switched.</li> </ul>
	<ul style="list-style-type: none"> <li>When the 3-wire function is used, the input of input terminal function F/R is reversed.</li> </ul>	<ul style="list-style-type: none"> <li>Check the logic of 3-wire normal rotation / reverse rotation terminal (018[F/R]).</li> </ul>
<p><b>S13: Noises of motor and machines are noisy.</b></p>	<ul style="list-style-type: none"> <li>Carrier frequency is set low.</li> </ul>	<ul style="list-style-type: none"> <li>Raise the carrier frequency setting [bb101]. However, this may increase noise generated in the inverter and leakage currents from the inverter. In addition, derating is required to the output current depending on the models.</li> </ul>
	<ul style="list-style-type: none"> <li>The revolution frequency of motor and the natural frequency of machines resonate.</li> </ul>	<ul style="list-style-type: none"> <li>Change the set frequency. If a resonance occurs during acceleration/deceleration, avoid the resonance frequency in settings of the frequency jump functions [AG101] to [AG106].</li> </ul>

Occurrence ▶	Estimated cause(s) ▶	Exemplar measures to be taken
<p><b>S14: Output frequency becomes unstable.</b></p>	<ul style="list-style-type: none"> <li>Inadequate parameters are used.</li> </ul>	<ul style="list-style-type: none"> <li>Find out the basic parameter settings for motor and set them accordingly.</li> </ul>
	<ul style="list-style-type: none"> <li>Load fluctuates significantly.</li> </ul>	<ul style="list-style-type: none"> <li>Re-examination of capacity of both motor and inverter may be required.</li> </ul>
	<ul style="list-style-type: none"> <li>PS voltage fluctuates.</li> </ul>	<ul style="list-style-type: none"> <li>Use of the optional reactor ALI or DCL, or a noise filter on the input side to minimize the power fluctuation may improve the situation.</li> </ul>
<p><b>S15: Torque is not generated.</b></p>	<ul style="list-style-type: none"> <li>V/f control is used.</li> </ul>	<ul style="list-style-type: none"> <li>Use torque boost, sensorless vector control, or other control instead.</li> </ul>
	<ul style="list-style-type: none"> <li>The inverter is used for lowering.</li> </ul>	<ul style="list-style-type: none"> <li>Use a braking resistor or regenerative braking unit if the torque is not sufficient for regenerative operation.</li> </ul>
	<ul style="list-style-type: none"> <li>The load is too heavy.</li> </ul>	<ul style="list-style-type: none"> <li>Re-examination of capacity of both motor and inverter may be required.</li> </ul>
<p><b>S16: Operator keypad disconnection error is issued.</b></p>	<ul style="list-style-type: none"> <li>Operation selection at disconnection of operator is inappropriate.</li> </ul>	<ul style="list-style-type: none"> <li>Set the operation selection at disconnection of operator to 02 (Ignore).</li> </ul>



Occurrence ▶	Estimated cause(s) ▶	Exemplar measures to be taken
<p><b>S17: Operation/setting of Modbus communication cannot be made.</b></p>	<ul style="list-style-type: none"> <li>Changes made to communication parameters haven't been reflected.</li> </ul>	<ul style="list-style-type: none"> <li>If you changed [CF-01] to [CF-38], turn OFF the control power supply and restart.</li> </ul>
	<ul style="list-style-type: none"> <li>The operation command selection is not set to RS485.</li> </ul>	<ul style="list-style-type: none"> <li>Check that operation command selection [AA111] is set to 03 (RS485).</li> </ul>
	<ul style="list-style-type: none"> <li>The frequency command selection is not set to RS485.</li> </ul>	<ul style="list-style-type: none"> <li>Check that the main speed command selection [AA111] is set to 03 (RS485).</li> </ul>
	<ul style="list-style-type: none"> <li>The communication speed setting is wrong.</li> </ul>	<ul style="list-style-type: none"> <li>Set the correct value in [CF-01], then turn OFF the control power supply and restart.</li> </ul>
	<ul style="list-style-type: none"> <li>Station numbers are wrongly set or overlapping each other.</li> </ul>	<ul style="list-style-type: none"> <li>Set the correct value in [CF-02], then turn OFF the control power supply and restart.</li> </ul>
	<ul style="list-style-type: none"> <li>The communication parity setting is wrong.</li> </ul>	<ul style="list-style-type: none"> <li>Set the correct value in [CF-03], then turn OFF the control power supply and restart.</li> </ul>
	<ul style="list-style-type: none"> <li>The communication stop bit setting is wrong.</li> </ul>	<ul style="list-style-type: none"> <li>Set the correct value in [CF-04], then turn OFF the control power supply and restart.</li> </ul>
	<ul style="list-style-type: none"> <li>Wiring is wrong,</li> </ul>	<ul style="list-style-type: none"> <li>Connect wires properly to the SP and SN terminals on the control circuit terminal block.</li> </ul>
<p><b>S18: The earth leakage circuit breaker is activated as the inverter is operated.</b></p>	<ul style="list-style-type: none"> <li>Leakage currents in the inverter are large.</li> </ul>	<ul style="list-style-type: none"> <li>Lower the carrier frequency [bb101].</li> <li>Raise the sensitivity current in the earth leakage circuit breaker, or replace the breaker with the one with higher sensitivity current.</li> </ul>
<p><b>S19: DC braking is disabled.</b></p>	<ul style="list-style-type: none"> <li>The DC braking force is not set.</li> </ul>	<ul style="list-style-type: none"> <li>Set DC braking force at the time of the stop [AF105] and DC braking force at the start [AF108].</li> </ul>
<ul style="list-style-type: none"> <li>The DC braking time is not set.</li> </ul>	<ul style="list-style-type: none"> <li>Set DC braking time at the time of the stop [AF106] and DC braking time at the start [AF109].</li> </ul>	
<p><b>S20: TV and radio have noises near the inverter.</b></p>	<ul style="list-style-type: none"> <li>Radiation noise from the inverter</li> </ul>	<ul style="list-style-type: none"> <li>Locate the inverter wires as far as possible from a TV and radio.</li> <li>Install ZCL to the main power supply input and output of the inverter.</li> </ul>



# 19

## Chapter 19 Maintenance and Inspection

### Contents

- 19.1 What This Chapter Explains ..... 19-1
- 19.2 Notes on Maintenance and Inspection ..... 19-2
  - 19.2.1 Daily Inspection ..... 19-2
  - 19.2.2 Cleaning ..... 19-2
  - 19.2.3 Periodic Inspection ..... 19-2
- 19.3 Daily Inspection and Periodic Inspection ..... 19-3
- 19.4 Megger Test ..... 19-4
- 19.5 Pressure Test ..... 19-4
- 19.6 Checking Method of Inverter and Converter. .... 19-5
- 19.7 Smoothing Capacitor Life Curve ..... 19-6
- 19.8 Life Alarming Output ..... 19-6
- 19.9 Measurement Method of I/O Voltage, Current, and Power ..... 19-7

### 19.1 What This Chapter Explains

- This chapter describes methods of maintenance and inspection.
- **Carefully read "Chapter 1 Safety Instructions" again before performing maintenance and inspection.**

\* Components that have finite lives are electrolytic condenser on board, smoothing capacitor, IGBT, diode module, current limiting resistor, relay for driving current limiting resistor or thyristor, cooling fan, and memory element, which are mounted on the board.

Be careful for maintenance and inspection!





**Electric shock**



**Do**

- **You run the risk of electric shock.**
- Before inspecting the inverter, be sure to turn off the power supply and wait for 10 minutes or more (\*1) or 15 minutes or more (\*2). (Confirm that the charge lamp on the inverter is turned off and the DC voltage between terminals P and N is 45 V or less.)



**Prohibited**



**Prohibited**

- Entrust only a designated person for maintenance, inspection, and replacement of parts. (Be sure to remove wristwatches and metal accessories, e.g., bracelets, before maintenance and inspection work. Be sure to use insulated tools for the work.)
- Do not perform pressure test.

\*1) For models P1-00044-L - P1-01240-L (P1-004L - P1-220L) and P1-00041-H - 00620-H (P1-007H - P1-220H)  
 \*2) For models P1-01530-L - P1-02950-L (P1-300L - P1-550L) and P1-00770-H - P1-03160-H (P1-300H - P1-1320H)

## 19.2 Notes on Maintenance and Inspection

### 19.2.1 Daily Inspection

As a basic procedure, check that the following abnormalities are not observed during operation.

No.	Description	Check
1	The motor operates according to the settings	<input type="checkbox"/>
2	There is no abnormality in the environment where the device is installed.	<input type="checkbox"/>
3	There is no abnormality in the cooling system.	<input type="checkbox"/>
4	No abnormal vibration or sound is observed.	<input type="checkbox"/>
5	No abnormal overheat or discoloration is observed.	<input type="checkbox"/>
6	No abnormal smell is observed.	<input type="checkbox"/>

While the inverter is running, check the input voltage of inverter using a tester, etc.

No.	Description	Check
1	There is no frequent occurrence of variation of power supply voltage.	<input type="checkbox"/>
2	Line voltage keeps a good balance.	<input type="checkbox"/>

### 19.2.2 Cleaning

Make sure to always keep the inverter clean for operation.

No.	Description	Check
1	For cleaning, lightly wipe off dirt with a soft cloth dampened with neutral detergent.	<input type="checkbox"/>
2	Solvents such as acetone, benzene, toluene, and alcohol may cause the inverter surface to dissolve or its coating to peel off, therefore, do not use them.	<input type="checkbox"/>
3	Do not clean the display section including the operator keypad using a detergent or alcohol.	<input type="checkbox"/>

### 19.2.3 Periodic Inspection

Check sections that cannot be inspected unless operation is stopped and sections requiring periodic inspection.

Please contact us for periodic inspection.

No.	Description	Check
1	There is no abnormality in the cooling system. • Cleaning of the air filter and other components	<input type="checkbox"/>
2	Checking tightness and re-tightening • Due to effects of vibration or temperature change, tightened portions of screws or bolts may loosen. Make sure to carefully check and perform the work.	<input type="checkbox"/>
3	No corrosion or damage is observed on the conductors and insulators.	<input type="checkbox"/>
4	Measurement of insulation resistance	<input type="checkbox"/>
5	Checking and replacing the cooling fan, smoothing capacitor, and relay	<input type="checkbox"/>

19.3 Daily Inspection and Periodic Inspection

Target section	Item	Details	Interval			Method	Criteria	Measurement instrument
			Daily	Periodic 1 year	2 years			
General	Ambient environment	Check the ambient temperature, humidity, dust, etc.	○			See the installation method.	The ambient temperature and humidity are within the usable range. No freezing, condensation, dust, corrosive gas, explosive gas, flammable gas, mist of grinding fluid, hydrogen sulfide, and salts are permissible.	Thermometer Hydrometer Recorder
	Entire device	No abnormal vibration or sound is observed.	○			By visual check and hearing	There must be no abnormality.	
	Power supply voltage	The main circuit voltage is normal.	○			Measure line voltage between inverter main circuit terminals R, S, and T.	They are within the allowable variation range of AC voltage.	Tester and digital multimeter
Main circuit	General	(1) Megger check (between the main circuit terminals and earth terminals)		○		Remove the input/output wires of main circuit terminal block of the inverter, remove the control terminal block board, then, remove the short bar for switching the functions of filter included in the inverter. Then, using a megger, perform measurement between each portion where R, S, T, U, V, W, P, PD, N, RB, R0, and T0 terminals are shorted and earth terminal.	The measured value shall be 5MΩ or above.	DC 500V-class megger
		(2) Fastened portions are not loosened.		○		Re-tighten the portion.	There must be no abnormality.	
		(3) No residual mark of overheat is observed on each component.		○		By visual check.	There must be no abnormality.	
	Connected conductor and wire	(1) The conductor is not distorted. (3) The coatings of wires are not torn.		○		By visual check.	There must be no abnormality.	
	Terminal block	It is not damaged.		○		By visual check.	There must be no abnormality.	
	Inverter Converter (including resistor)	Check resistance between each terminal			○	Remove the wires of the main circuit terminal block of inverter, and perform measurement between terminals R, S, T and terminals P, N, and between terminals U, V, W and terminals P, N at the range of tester ×1Ω.	See 6.5 Checking method of inverter and converter. Appropriate replacement interval of inverter, converter, and thyristor Start/stop: 10 <sup>6</sup> cycles *3)	Analog tester
	Smoothing capacitor	(1) There is no leakage of fluid. (2) The belly (safety valve) shall not stick and there shall be no bump.	○	○		By visual check.	There must be no abnormality. Appropriate service years for replacement: 10 years *1) *3) *4)	
	Relay	(1) There shall be no beat noise during operation. (2) There are no worn contacts.		○	○	By hearing. By visual check.	There must be no abnormality. There must be no abnormality.	
Control circuit Protective circuit	Operation check	(1) Through unit operation of inverter, check balance of output voltage between each phase.		○		Measure line voltage between inverter main circuit terminals U, T, and W.	Inter-phase voltage balance 200V class: To be within 4V. 400V class: To be within 8V.	Digital multimeter Flowmeter Voltmeter
		(2) By conducting the sequence protective operation test, check there is no abnormality in protective operation and display circuit.		○		Simulate short or open condition of the protective circuit output of inverter.	The error is generated on the sequence.	
Cooling system	Cooling fan	No abnormal vibration or sound is observed. (2) Connections are not loosened.	○			By hearing and visual check. (Warning indication on the operator keypad) By visual check.	To rotate smoothly. There must be no abnormality. Wind brows in upper section. Appropriate service years for replacement: 10 years *2) *3) *5)	
	Cooling fin	There is no clogging.		○		By visual check.	There is no clogging.	
Indication	Indication	(1) The LED lamp and screen display are normal. (2) Cleaning.	○			By visual check. Clean with a waste cloth.	Check the lamp/display lights up.	
	External meter	The indicated values are normal.	○			Check indicated values of the meters on the boards.	Satisfy the specification values and control values.	Voltmeter, ammeter, etc.
Motor	General	(1) No abnormal vibration or sound is observed.	○			By hearing, sensing, and visual check.	There must be no abnormality.	
		(2) No abnormal smell is observed.	○			Check for abnormal smell due to overheat, damage, etc.	There must be no abnormality.	
	Insulation resistance	Megger check (between the main circuit terminals and earth terminals)			*6)	Disconnect U, V, and W inverter main circuit terminals, short the motor line (for three phases), and perform measurement between the motor wire and earth terminal using a megger.	The measured value shall be 5MΩ or above.	DC 500V-class megger

\*1) The service life of smoothing capacitor is affected by the ambient temperature. See "5.Smoothing capacitor life curve" to determine replacement period.  
 \*2) The life of cooling fan varies depending on the environment conditions such as ambient temperature and dust. Check operating conditions by daily inspection.  
 \*3) The replacement period (number of years/cycles) and "5. Smoothing capacitor life curve" are based on the designed expected life, which is not a guaranteed value.

\*4) When you replace with a capacitor that has passed storage period more than three years, perform aging in the following conditions before using it.  
 • Initially apply 80% of rated voltage of capacitor for one hour in normal temperature  
 • Then, increase the voltage to 90% and apply for one hour  
 • Lastly, apply rated voltage for five hours in normal temperature  
 \*5) If the cooling fan is locked due to dust, etc., it takes about 5 to 10 seconds until re-rotation is enabled even if dust is removed.  
 \*6) Perform inspection in accordance with the instruction manual of motor.

## 19.4 Megger Test

- When conducting megger test on the external circuit, remove all terminals of the inverter to avoid applying the test voltage is not applied to the inverter.
- For energization test on the control circuit, use a tester (high-resistance range), and do not use a megger or buzzer.
- Conduct megger test for the inverter itself only on the main circuit, and do not perform megger test on the control circuit.
- For megger test, use a DC500V megger.
- Before conducting a megger test on the inverter main circuit, make sure to remove the short bar for switching the filtering function included in the inverter, and short terminals R, S, T, U, V, W, P, PD, N, RB, R0, and T0 as shown in the figure below.
- After megger test, remove the wires on which R, S, T, U, V, W, P, PD, N, RB, R0, and T0 terminals that are shorted, and connect the short bar for switching the filter function included in the inverter to the original position.

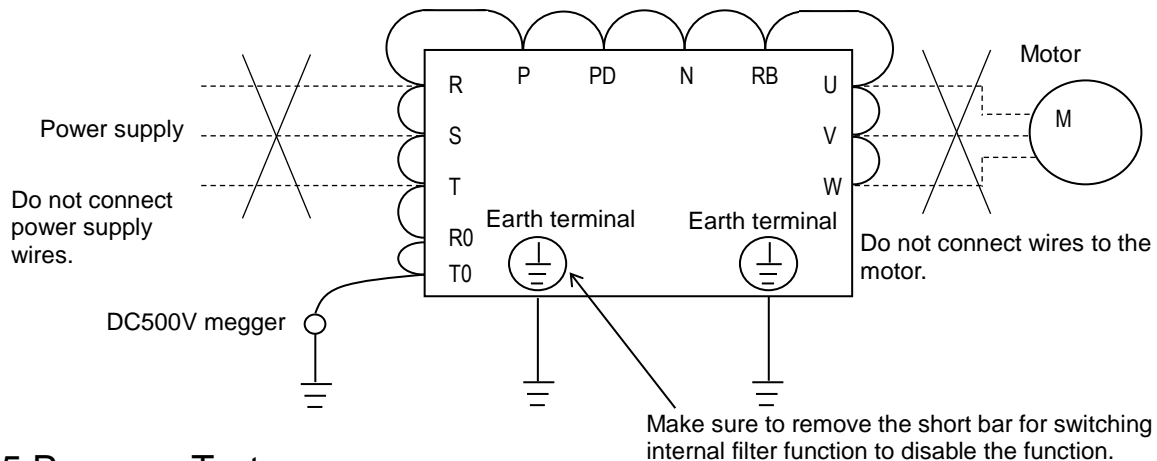

## 19.5 Pressure Test

- Do not perform pressure test.  
If pressure test is conducted, it is dangerous because the components inside the inverter may be damaged or deteriorated.

### 19.6 Checking Method of Inverter and Converter.

- Using a tester, you can check the condition of inverter and converter if it is good or bad. (preparation)
  - (i) Remove the power lines connected from an external source (R, S, T), wires connecting to the motor (U, V, W), and regenerative braking resistor (P, RB).
  - (ii) Prepare a tester. (The range used is 1Ω resistance measurement range.)
- (Checking method) \*1)
  - You can determine the good-or-bad condition of conduction status of terminals on the inverter main circuit terminal block R, S, T, U, V, W, RB, P, and N by alternately changing the polarity of tester for measurement.

- \*1) By measuring the voltage between P and N in the DC voltage range, check that electricity is fully discharged from the smoothing capacitor before performing check.
- \*2) When electricity is not conducted, a nearly infinite value is demonstrated. Due to effects of the smoothing capacitor, electricity may be conducted instantly, not showing an infinite value. When electricity is conducted, a numeric value range will be indicated from some to dozens in a unit of Ω. The values vary depending on the element type, tester, type, etc. However, it is acceptable if numeric values obtained for each item are nearly the same. The measured value may be varied some degree in Ω by the reason of the preventing inrush current of current limiting resistor.
- \*3) The braking circuit (BRD) section is equipped as standard on the following models: P1-00044-L - P1-01240-L (P1-004L~P1-220L) and P1-00041-H - P1-00930-H (P1-007H~P1-370H)

		Tester polarity		Measured value *2)
		⊕ (Red)	⊖ (Black)	
Converter	D1	R	PD	Non-conductive
		PD	R	Conductive
	D2	S	PD	Non-conductive
		PD	S	Conductive
	D3	T	PD	Non-conductive
		PD	T	Conductive
D4	R	N	Conductive	
	N	R	Non-conductive	
D5	S	N	Conductive	
	N	S	Non-conductive	
D6	T	N	Conductive	
	N	T	Non-conductive	
Inverter	TR1	U	P	Non-conductive
		P	U	Conductive
	TR2	V	P	Non-conductive
		P	V	Conductive
	TR3	W	P	Non-conductive
		P	W	Conductive
TR4	U	N	Conductive	
	N	U	Non-conductive	
TR5	V	N	Conductive	
	N	V	Non-conductive	
TR6	W	N	Conductive	
	N	W	Non-conductive	
BRD	TR7	RB	P	Non-conductive
		P	RB	Conductive
		RB	N	Non-conductive
		N	RB	Non-conductive

**Model (P1-\*\*\*\*-\*)**  
 200V class: 00044-L (004L) - 00600-L (110L)  
 400V class: 00041-H (007H) - 00310-H (110H)

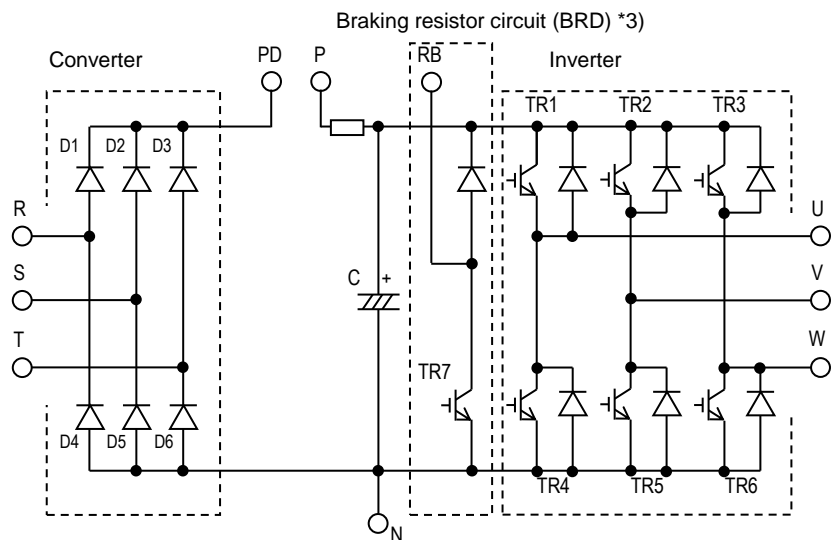

**Model (P1-\*\*\*\*-\*)**  
 200V class: 00800-L (150L) - 02950-L (550L)  
 400V class: 00400-H (150H) - 03160-H (1320H)

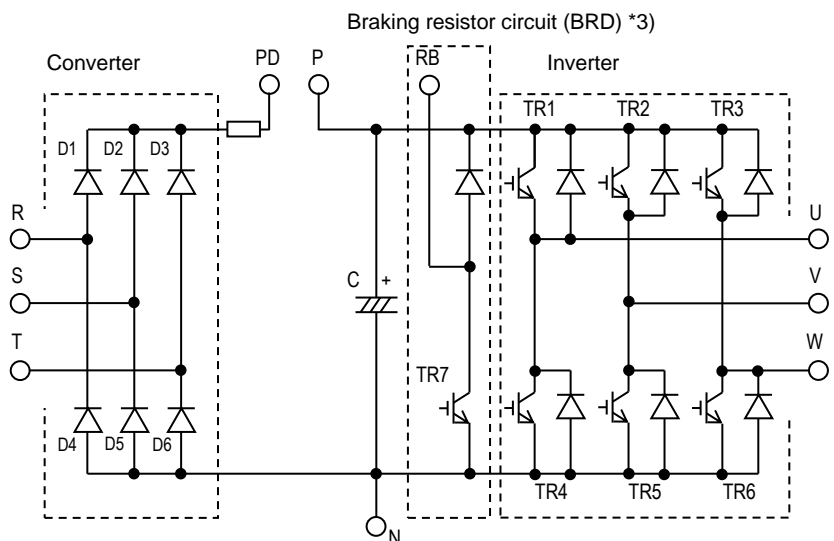

19.7 Smoothing Capacitor Life Curve

\* When the inverter is continuously driven at 80% of ND rated current.

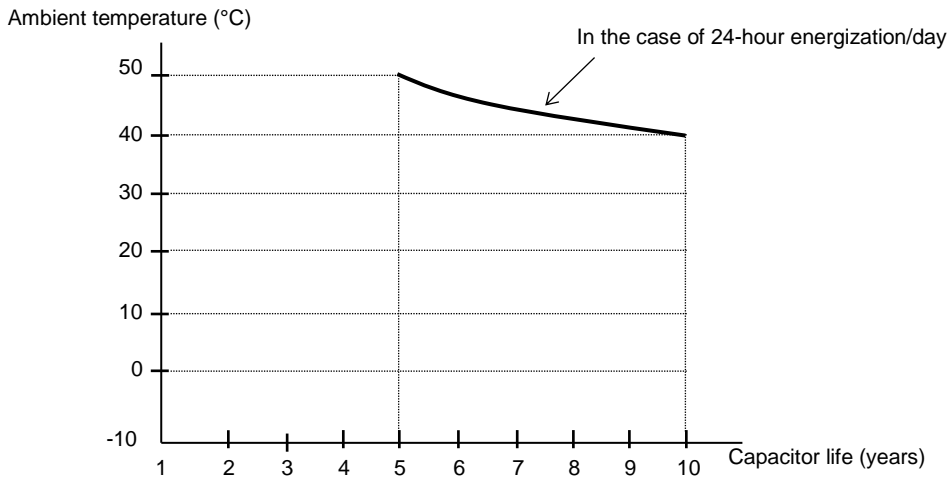

Note 1) The ambient temperature is a temperature measured at a position about 5cm from the bottom center of the inverter. (atmospheric temperature)  
If the inverter is stored inside the panel, it is in-panel temperature.

Note 2) The smoothing capacitor is a finite life component which occurs chemical reaction inside, replacement is required after 10 years of use (It is a designed expected life, not a guaranteed value).  
However, if the inverter is used in an environment at high temperature or in a heavy-load environment where the its rated current is exceeded, the life is significantly shortened.

19.8 Life Alarming Output

- When the life of component (smoothing capacitor or cooling fan on the board, excluding the main circuit smoothing capacitor) is near its end, an alarm can be generated based on self-diagnosis. Use this alarm as a sign of part replacement period. For details, see the life diagnosis monitor [dC-16] and output terminal function selection [CC-01] to [CC-07]. Note that alarms are generated based on diagnosis of designed expected life (not a guaranteed value). There will be differences due to use environments, operating conditions, etc. Please conduct maintenance in advance.



19.9 Measurement Method of I/O

Voltage, Current, and Power

The following shows general measurement instruments used for measurement of input/output voltage, current, and power.

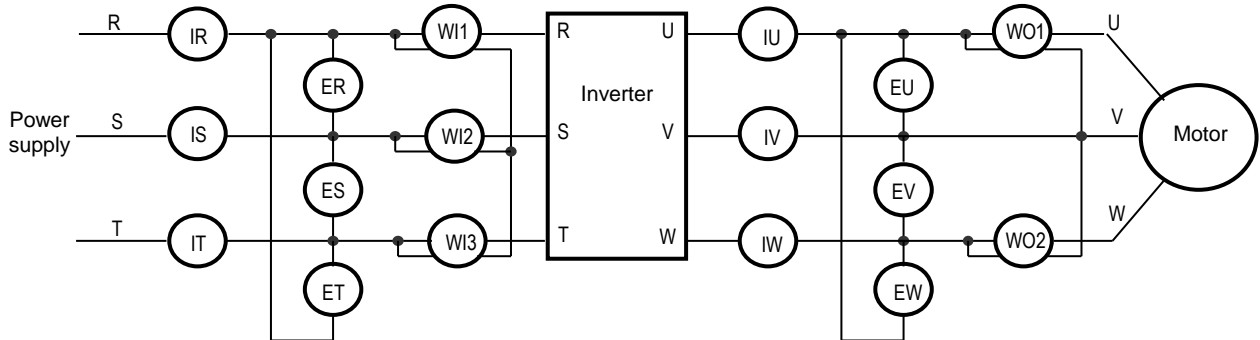

Measurement item	Target section	Measurement instrument	Remarks	Criteria
Power supply voltage $E_{IN}$	Between R-S, S-T, and T-R ( $E_R$ ), ( $E_S$ ), ( $E_T$ )	Moving iron voltmeter or Rectifier type voltmeter	All effective values	200V class: 200-240V 50/60Hz 400V class: 380-500V 50/60Hz
Power supply current $I_{IN}$	Current of R, S, and T ( $I_R$ ), ( $I_S$ ), ( $I_T$ )	Moving iron ammeter	All effective values	If input current is imbalanced $I_{IN}=(I_R+I_S+I_T)/3$
Power from power supply $W_{IN}$	Between R-S, S-T, and T-R ( $W_{I1}$ )+( $W_{I2}$ )+( $W_{I3}$ )	Electrodynamometer type wattmeter	All effective values	Three wattmeter method
Power rate of power supply $P_{FIN}$	This value is calculated using measurement values of power supply voltage $E_{IN}$ , power supply current $I_{IN}$ , and power supply power $W_{IN}$ . $P_{FIN} = \frac{W_{IN}}{\sqrt{3} \cdot E_{IN} \cdot I_{IN}} \times 100$			
Output voltage $E_{OUT}$	Between U-V, V-W, and W-U ( $E_U$ ), ( $E_V$ ), ( $E_W$ )	See the figure below or Rectifier type voltmeter	Effective value of fundamental wave	
Output current $I_{OUT}$	Current of U, V, and W ( $I_U$ ), ( $I_V$ ), ( $I_W$ )	Moving iron ammeter	All effective values	
Output power $W_{OUT}$	Between U-V and V-W ( $W_{O1}$ )+( $W_{O2}$ )	Electrodynamometer type wattmeter	All effective values	Two wattmeter method (or three wattmeter method)
Output power factor $P_{IOUT}$	This value is calculated using measurement values of output voltage $E_{OUT}$ , output current $I_{OUT}$ , and output power $W_{OUT}$ . $P_{IOUT} = \frac{W_{OUT}}{\sqrt{3} \cdot E_{OUT} \cdot I_{OUT}} \times 100$			

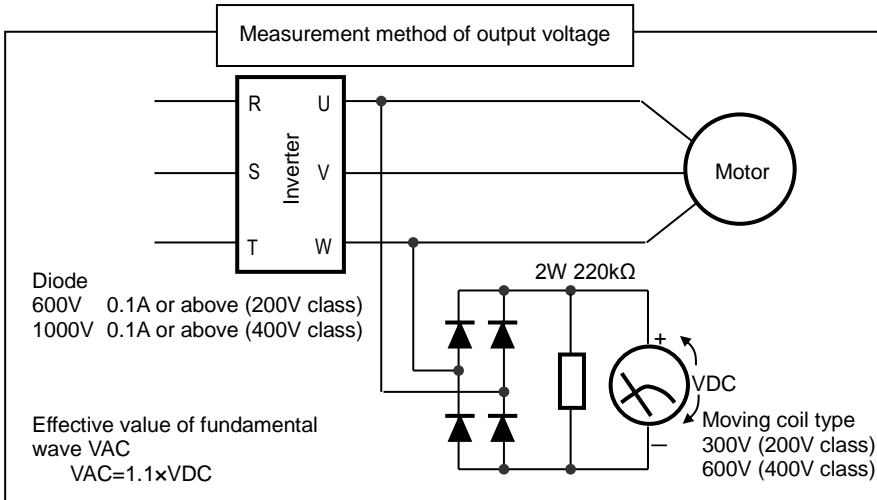

Note)

1. Use an instrument that indicates effective values of fundamental wave for output voltage, and use instruments that indicate all effective values for current and power.
2. The output waveform of inverter generates errors especially at low frequency because it is a waveform control by PWM. Take care because a tester (general-purpose product) may not be adapted due to noise.

(Memo)

## 20

# Chapter 20 Specifications

## Contents

20.1 What This Chapter Explains .....	20-1
20.2 Inverter Specifications .....	20-2
20.2.1 200V Class Specifications .....	20-2
20.2.2 400V Class Specifications .....	20-3
20.2.3 Common Specifications .....	20-4
20.3 External dimensions .....	20-6
20.4 Current Derating Table.....	20-14
20.4.1 200V class.....	20-14
20.4.2 400V class.....	20-17

## 20.1 What This Chapter Explains

This chapter describes product specifications. The abbreviations used in the product specifications show the following meanings.

### Rated duty:

- ND (normal duty rating)
- LD (low duty rating)
- VLD (very low duty rating)

### Motor types:

- IM (induction motor)
- SM/PMM: (synchronous motor/permanent magnet motor)



In the following specifications, information after input power may be omitted. In this case, the specifications described are not related to the omitted part. For product models, see "Chapter 4.3.1 Product Models".

## 20.2 Inverter Specifications

### 20.2.1 200V Class Specifications

\* The models in 200V class are shown as P1-\*\*\*\*\*-LFF or P1-\*\*\*\*\*-LFUF. The portion "\*\*\*\*\*" are filled with numbers described in "Model symbol".

Model symbol P1-*****-L		00044	00080	00104	00156	00228	00330	00460	00600	00800	00930	01240	01530	01850	02290	02950		
ND capacity standard notation P1-***L		004	007	015	022	037	055	075	110	150	185	220	300	370	450	550		
Applicable motor (4-pole) capacity (kW)	VLD	0.75	1.5	2.2	3.7	5.5	7.5	11	15	18.5	22	30	37	45	55	75		
	LD	0.75	1.5	2.2	3.7	5.5	7.5	11	15	18.5	22	30	37	45	55	75		
	ND	0.4	0.75	1.5	2.2	3.7	5.5	7.5	11	15	18.5	22	30	37	45	55		
Output	Rated output current (A)	VLD	4.4	8.0	10.4	15.6	22.8	33.0	46.0	60.0	80.0	93.0	124	153	185	229	295	
		LD	3.7	6.3	9.4	12.0	19.6	30.0	40.0	56.0	73.0	85.0	113	140	169	210	270	
		ND	3.2	5.0	8.0	11.0	17.5	25.0	32.0	46.0	64.0	76.0	95.0	122	146	182	220	
	Overload current rating *1)	VLD	110% 60sec / 120% 3sec															
		LD	120% 60sec / 150% 3sec															
		ND	150% 60sec / 200% 3sec															
	Rated output voltage		3-phase (3-wire) 200-240V (depending on receiving voltage)															
	Rated capacity (kVA)	200V	VLD	1.5	2.8	3.6	5.4	7.9	11.4	15.9	20.8	27.7	32.2	43.0	53.0	64.1	79.3	102.2
			LD	1.3	2.2	3.3	4.2	6.8	10.4	13.9	19.4	25.3	29.4	39.1	48.5	58.5	72.7	93.5
			ND	1.1	1.7	2.8	3.8	6.1	8.7	11.1	15.9	22.2	26.3	32.9	42.3	50.6	63.0	76.2
240V		VLD	1.8	3.3	4.3	6.5	9.5	13.7	19.1	24.9	33.3	38.7	51.5	63.6	76.9	95.2	122.6	
		LD	1.5	2.6	3.9	5.0	8.1	12.5	16.6	23.3	30.3	35.3	47.0	58.2	70.3	87.3	112.2	
		ND	1.3	2.1	3.3	4.6	7.3	10.4	13.3	19.1	26.6	31.6	39.5	50.7	60.7	75.7	91.5	
Input	Rated input current (A) *2)	VLD	5.2	9.5	12.4	18.6	27.1	39.3	54.8	71.4	95.2	110.7	147.6	182.1	220.2	272.6	351.2	
		LD	4.4	7.5	11.2	14.3	23.3	35.7	47.6	66.7	86.9	101.2	134.5	166.7	201.2	250.0	321.4	
		ND	3.8	6.0	9.5	13.1	20.8	29.8	38.1	54.8	76.2	90.5	113.1	145.2	173.8	216.7	261.9	
	Rated input AC voltage *3)	Control power supply: Power supply single phase 200-240V/allowable variation range 170-264V, 50Hz (allowable variation range: 47.5~52.5Hz)/60Hz (allowable variation range: 57-63Hz)																
		Main circuit power supply: 3-phase (3-wire) 200-240V/allowable variation range 170-264V, 50Hz (allowable variation range: 47.5-52.5Hz)/60Hz (allowable variation range: 57-63Hz)																
	Power supply equipment capacity (kVA) *4)	VLD	2.0	3.6	4.7	7.1	10.3	15.0	20.9	27.2	36.3	42.2	56.3	69.4	83.9	103.9	133.8	
		LD	1.7	2.9	4.3	5.4	8.9	13.6	18.1	25.4	33.1	38.6	51.3	63.5	76.7	95.3	122.5	
		ND	1.5	2.3	3.6	5.0	7.9	11.3	14.5	20.9	29.0	34.5	43.1	55.3	66.2	82.6	99.8	
	Carrier frequency operating range *5)	VLD	0.5~10.0kHz															
LD		0.5~12.0kHz																
ND		0.5~16.0kHz																
Motor start torque*6)		200%/0.3Hz																
Braking	Regenerative braking	Equipped with BRD circuit (with a discharging resistor separately installed)											Regenerative braking unit separately installed					
	Minimum resistance that can be connected (Ω)	50	50	35	35	35	16	10	10	7.5	7.5	5	-	-	-	-		
Dimension *7)	H (height) (mm)	255	255	255	255	255	260	260	260	390	390	390	540	550	550	700		
	W (width) (mm)	150	150	150	150	150	210	210	210	245	245	245	300	390	390	480		
	D (depth) (mm)	140	140	140	140	140	170	170	170	190	190	190	195	250	250	250		
Protective construction		IP20 / UL open type																
Approximate mass (kg)		3	3	3	3	3	7	7	7	16	16	16	22	30	30	43		

\*1) The values shown are ratings when carrier frequency is at 2kHz. Please use the inverter in accordance with "20.4 Current Derating Table".

\*2) The rated input currents shown in the table are the values when the rated current is output. The values vary depending on impedance on the power supply (wiring, breaker, input reactor option, etc.)

\*3) The following shows response to the Low Voltage Directive.  
- Pollution degree 2  
- Overvoltage category 3

\*4) The power supply equipment capacities shown in the table are the values when 220V rated current is output. The values vary depending on impedance on the power supply (wiring, breaker, input reactor option, etc.)

\*5) The setting of rated values for carrier frequencies [bb101]/[bb201] are internally limited in accordance with the description. Also, it is recommended to set values equivalent to or above (maximum output frequency for driving  $\times 10$ ) Hz for the setting of carrier frequencies [bb101]/[bb201]. Also, in the case of induction motor (IM) control, for items other than those subject to V/f control, it is recommended to set carrier frequency at 2kHz or more. In the case of synchronous motor (SM)/permanent magnet motor (PMM) control, it is recommended to set carrier frequency at 8kHz or more.

\*6) Values when sensorless vector control is applied at ND rating on a Hitachi's standard motor. Torque characteristics may be different depending on the control method or motor for use.

\*7) The dimensions do not include buttons on the operator keypad. When optional items are connected, the required dimensions will increase. Check the instruction manuals of each optional item for details.

20.2.2 400V Class Specifications

\* The models in 400V class are shown as P1-\*\*\*\*\*-HFF or P1-\*\*\*\*\*-HFEF, P1-\*\*\*\*\*-HFUF, or P1-\*\*\*\*\*-HFCE.\*\*\*\*\* filled with numbers described in "Model symbol".

Model symbol P1-*****-H		00041	00054	00083	00126	00175	00250	00310	00400	00470	00620	00770	00930	01160	01470	01760	02130	02520	03160			
ND capacity standard notation P1-***H		007	015	022	037	055	075	110	150	185	220	300	370	450	550	750	900	1100	1320			
Applicable motor (4-pole) capacity (kW)		VLD	1.5	2.2	3.7	5.5	7.5	11	15	18.5	22	30	37	45	55	75	90	110	132	160		
		LD	1.5	2.2	3.7	5.5	7.5	11	15	18.5	22	30	37	45	55	75	90	110	132	160		
		ND	0.75	1.5	2.2	3.7	5.5	7.5	11	15	18.5	22	30	37	45	55	75	90	110	132		
Output		Rated output current (A)		VLD	4.1	5.4	8.3	12.6	17.5	25.0	31.0	40.0	47.0	62.0	77.0	93.0	116	147	176	213	252	316
				LD	3.1	4.8	6.7	11.1	16.0	22.0	29.0	37.0	43.0	57.0	70.0	85.0	105	135	160	195	230	290
				ND	2.5	4.0	5.5	9.2	14.8	19.0	25.0	32.0	39.0	48.0	61.0	75.0	91.0	112	150	180	217	260
		Overload current rating		VLD	110% 60sec / 120% 3sec																	
				LD	120% 60sec / 150% 3sec																	
				ND	150% 60sec / 200% 3sec																	
Rated output voltage		3-phase (3-wire) 380-500V (depending on receiving voltage)																				
Rated capacity (kVA)		400V		VLD	2.8	3.7	5.8	8.7	12.1	17.3	21.5	27.7	32.6	43.0	53.3	64.4	80.4	101.8	121.9	147.6	174.6	218.9
				LD	2.1	3.3	4.6	7.7	11.1	15.2	20.1	25.6	29.8	39.5	48.5	58.9	72.7	93.5	110.9	135.1	159.3	200.9
				ND	1.7	2.8	3.8	6.4	10.3	13.2	17.3	22.2	27.0	33.3	42.3	52.0	63.0	77.6	103.9	124.7	150.3	180.1
		500V		VLD	3.6	4.7	7.2	10.9	15.2	21.7	26.8	34.6	40.7	53.7	66.7	80.5	100.5	127.3	152.4	184.5	218.2	273.7
				LD	2.7	4.2	5.8	9.6	13.9	19.1	25.1	32.0	37.2	49.4	60.6	73.6	90.9	116.9	138.6	168.9	199.2	251.1
				ND	2.2	3.5	4.8	8.0	12.8	16.5	21.7	27.7	33.8	41.6	52.8	65.0	78.8	97.0	129.9	155.9	187.9	225.2
Input		Rated input current (A) *1)		VLD	4.9	6.4	9.9	15.0	20.8	29.8	36.9	47.6	56.0	73.8	91.7	110.7	138.1	175.0	209.5	253.6	300.0	376.2
				LD	3.7	5.7	8.0	13.2	19.0	26.2	34.5	44.0	51.2	67.9	83.3	101.2	125.0	160.7	190.5	232.1	273.8	345.2
				ND	3.0	4.8	6.5	11.0	17.6	22.6	29.8	38.1	46.4	57.1	72.6	89.3	108.3	133.3	178.6	214.3	258.3	309.5
		Rated input AC voltage *2)		Control power supply: Power supply single phase 380-500V (allowable variation range 323-550V), 50Hz (allowable variation range: 47.5-52.5Hz)/60Hz (allowable variation range: 57-63Hz) Main circuit power supply: 3-phase (3-wire) 380-500V (allowable variation range) 323-550V, 50Hz (allowable variation range: 47.5-52.5Hz)/60Hz (allowable variation range: 57-63Hz)																		
Power supply equipment capacity (kVA) *3)		VLD	3.7	4.9	7.5	11.4	15.9	22.7	28.1	36.3	42.6	56.3	69.9	84.4	105.2	133.4	159.7	193.2	228.6	286.7		
		LD	2.8	4.4	6.1	10.1	14.5	20.0	26.3	33.6	39.0	51.7	63.5	77.1	95.3	122.5	145.2	176.9	208.7	263.1		
		ND	2.3	3.6	5.0	8.3	13.4	17.2	22.7	29.0	35.4	43.5	55.3	68.0	82.6	101.6	136.1	163.3	196.9	235.9		
Carrier frequency range *4)		VLD	0.5~10.0kHz														0.5~8.0kHz					
		LD	0.5~12.0kHz														0.5~8.0kHz					
		ND	0.5~16.0kHz														0.5~10.0kHz					
Motor start torque*5)		200%/0.3Hz														180%/0.3Hz						
Braking		Regenerative braking		Equipped with braking resistance circuit (with a discharging resistor separately installed)												*6)		Regenerative braking unit separately installed				
		Minimum resistance that can be connected (Ω)		100	100	100	70	70	35	35	24	24	20	15	15	10	10	-	-	-	-	
Dimension *7)		H (height) (mm)		255	255	255	255	260	260	260	390	390	390	540	550	550	550	700	700	740	740	
		W (width) (mm)		150	150	150	150	210	210	210	245	245	245	300	390	390	390	390	390	390	480	480
		D (depth) (mm)		140	140	140	140	170	170	170	190	190	190	195	250	250	250	270	270	270	270	270
Protective construction		IP20 / UL open type																				
Approximate mass (kg)		3	3	3	3	7	7	7	16	16	16	22	30	30	30	55	55	70	70			

\*1) The values shown are ratings when carrier frequency is at 2kHz. Please use the inverter in accordance with "20.4 Current Derating Table".  
 \*2) The rated input currents shown in the table are the values when the rated current is output. The values vary depending on impedance on the power supply (wiring, breaker, input reactor option, etc.)  
 \*3) The following shows response to the Low Voltage Directive.  
 - Pollution degree 2  
 - Overvoltage category 3 (when input voltage is between 380 and 460 VAC)  
 - Overvoltage category 2 (when input voltage is higher than 460 VAC)  
 \*4) The power supply equipment capacities shown in the table are the values when 440V rated current is output. The values vary depending on impedance on the power supply (wiring, breaker, input reactor option, etc.)  
 \*5) The setting of rated values for carrier frequencies [bb101]/[bb201] are internally limited in accordance with the description. Also, it is recommended to set values equivalent to or above (maximum output frequency for driving x10) Hz for the setting of carrier frequencies [bb101]/[bb201]. Also, in the case of induction motor (IM) control, for items other than those subject to V/f control, it is recommended to set carrier frequency at 2kHz or more. In the case of synchronous motor (SM)/permanent magnet motor (PMM) control, it is recommended to set carrier frequency at 8kHz or more.

\*6) Values when sensorless vector control is applied at ND rating on a Hitachi's standard motor. Torque characteristics may be different depending on the control method or motor for use.  
 \*7) The dimensions do not include buttons on the operator keypad. When optional items are connected, the required dimensions will increase. Check the instruction manuals of each optional item for details.  
 \*8) Usually a regenerative braking unit needs to be separately installed, however, in response to your order, we can install the braking circuit internally and attach a discharging resistor, thereby eliminating the need for the regenerative braking unit. Please contact the sales officer of our company shown in the back cover.

## 20.2.3 Common Specifications

Control mode (output to the motor)		Sine wave PWM control voltage output (line sine wave modulation)		
Output frequency range *1)		0.00~590.00Hz		
Frequency accuracy		Digital command $\pm 0.01\%$ and analog command $\pm 0.2\%$ (25 $\pm 10^\circ\text{C}$ ) against the maximum frequency		
Frequency resolution		Digital setting: 0.01Hz Analog setting: maximum frequency/4000 (Ai1 terminal/Ai2 terminal: 12bit/0 - +10V or 0 - +20mA, Ai3 terminal 12bit/-10 - +10V)		
Control mode (frequency/voltage calculation) *2)		IM	V/f control (fixed torque/reduced torque/free), automatic boost control, cascade model sensorless vector control, 0 Hz range sensorless vector control, vector control with sensor.	
		SM/PMM	Synchronous starting sensorless vector control, IVMS starting smart sensorless vector control	
Speed fluctuation *3)		$\pm 0.5\%$ (during sensorless vector control)		
Acceleration or deceleration time		0.00-3600.00sec (linear, S-shaped, U-shaped, reverse U-shaped, EL-S shaped)		
Display monitor		Output frequency, output current, output torque, trip history, I/O terminal status, I/O power *4), P-N voltage and others described in "Chapter 13 Information Monitoring Functions".		
Starting functions		Start after DC braking, frequency collection start, frequency entrainment start, reduced voltage start, retry start		
Stopping functions		Free-run stop, DC braking after deceleration stop or terminal DC braking (braking power, operating speed adjustment)		
Stall prevention function		Overload restraining function, overcurrent suppression function, overvoltage suppression function		
Protective function *5)		Overcurrent error, Motor overload error, Braking resistor Overload error, Overvoltage error, Memory error, Undervoltage error, Current detector error, CPU error, External trip error, USP error, Ground fault error, Excessive voltage of accepted power error, Instantaneous power failure error, Temperature detector error, Reduction of revolutions of cooling fan, Temperature error, Input phase loss error, IGBT error, Output phase loss error, Thermistor error, Brake error, Low-speed range overload error, Inverter overload error, RS485 communication error, and others described in "Chapter 18 Tips/FAQ/Troubleshooting".		
Other functions		V/f free settings (7 points), Upper/lower limit frequency limiter, Frequency jump, Curve acceleration/deceleration, Manual torque boost, Energy-saving operation, Analog output adjustment function, Minimum frequency, Carrier frequency adjustment, Motor electronic thermal function (free setting is also possible), Inverter electronic thermal function, External start/end (volume/ratio), Frequency input selection, Trip retry, Restart after instantaneous stop, Output of signals, Initialization settings, PID control, Automatic deceleration at power shut-off, Brake control function, Auto-tuning for commercial switching function (online/offline), and others described in "Chapter 12 Inverter Functions".		
Input	Frequency setting	Standard operator keypad	Parameter setting using arrow keys	
		External signals *6)	Ai1/Ai2 terminal (when changing voltage)	Setting through input of 0-10VDC voltage (input impedance: 10k $\Omega$ )
			Ai1/Ai2 terminal (when changing current)	Setting through input of 0-20mA current (input impedance: 100 $\Omega$ )
			Ai3 terminal	Setting through input of -10-+10VDC voltage (input impedance: 10k $\Omega$ )
			Multistage speed terminal (use of input terminal function)	15th speed
	External port	Setting via RS485 serial communication (protocol: Modbus-RTU)		
	Normal rotation/reverse rotation Run/stop	Standard operator keypad	Execution with the RUN /STOP key (normal rotation/reverse rotation can be switched by setting parameters)	
		External signals	Normal rotation operation (FW)/reverse rotation (RV) (when an input terminal function is assigned) 3-wire input available (when an input terminal function is assigned)	
		External port	Setting via RS485 serial communication (protocol: Modbus-RTU (maximum: 115.2kbps))	
	Input terminal function	11 terminals (input of pulse string is available on terminal A and B) FW (Normal rotation)/RV (Reverse rotation), CF1-4(Multistage speed 1-4), SF1-7 (Multistage speed bit 1-7), ADD (Addition of frequency), SCHG (Switching of frequency command), STA (3-wire start)/STP (3-wire stop)/F_R (3-wire normal/reverse), AHD (Retention of analog command), FUP (Increase of speed via remote operation)/FDN (Deceleration via remote operation), UDC (Deletion of data via remote operation), F-OP (Forced command switching), SET (Second control), RS (Reset), JG (Jogging), DB (External current braking), 2CH (2-stage acceleration/deceleration), FRS (Free-run stop), EXT (External abnormality), USP (Prevention of restart after restoration of power), CS (Commercial switching), SFT (Soft-lock), BOK (Brake check), OLR (Overload restriction switching), KHC (Clearance of integrated input power), OKHC (Clearance of integrated output power), PID (PID1 disabled), PIDC (PID1 integration reset), PID2 (PID2 disabled), PIDC2 (PID2 integration reset), SVC1-4 (PID1 multistage target values 1-4), PRO (PID gain switching), PIO (PID output switching), SLEP (SLEEP condition satisfied)/WAKE (WAKE condition satisfied), TL (Torque restriction enabled), TRQ1, 2 (Switching of torque limit 1,2), PPI (Switching of P/PI control), CAS (Switching of control gain), FOC (Preparatory excitation), ATR (Torque control enabled), TBS (Torque bias enabled), LAC (Cancellation of acceleration/deceleration), Mi1-11 (General-purpose input 1-11), PCC (Clearance of pulse counter), ECOM (Start of EzCOM), PRG (Program run), HLD (Acceleration/deceleration stop), REN (Operation permission signal), PLA (Pulse string input A, PLB (Pulse string input B), and others described in "12.24.1 Using the input signal function externally"		
Backup power supply terminal	P+/P-: DC24V input (allowable input voltage: 24V $\pm 10\%$ )			
STO input terminal	2 terminals (simultaneous input)			
Thermistor input terminal	1 terminal (possible to switch between positive temperature coefficient/negative temperature coefficient resistance element)			

\*1) The output frequency range depend on the control and motor used. When running the inverter exceeding 60Hz, check the maximum allowable frequency with the manufacturer of the motor.

\*2) When the control mode is changed, unless the motor constant is appropriately configured, you cannot obtain the desired starting torque or the inverter may trip.

\*3) The variable range of motor speed may vary depending on your system or the environment where the motor is used. Please contact us for details.

\*4) Both the input power and output power are reference values, which are not appropriate for use in calculation of efficiency values, etc. To obtain an accurate value, use an external device.

\*5) The IGBT error [E030] is generated by the protective function not only for short circuit protection but also when IGBT is damaged. Depending on the operating conditions of the inverter, the overcurrent error [E001] may occur, instead of the IGBT error.

\*6) At the factory default setting, when voltage and current on Ai1/Ai2 terminal is changed using a switch, with input of voltage at 9.8V and current at 19.8mA, the maximum frequency is commanded. To change characteristics, make adjustments using the analog start/end function.

## Common specifications (continued)

Output	Output terminal function	Transistor output 5 terminal, 1a contact relay 1 point, 1c contact relay 1 point	
	Relay and alarm relay (1a, 1c)	RUN (During operation), FA1-5 (Reached signal), IRDY (Operation ready completion), FWR (During normal rotation operation), RVR (During reverse rotation operation), FREF (Frequency command operator keypad), REF (Operation command operator keypad), SETM (Second control under selection), AL (Alarm signal), MJA (Severe failure signal), OTQ (Over torque)*7, IP (During instantaneous power failure), UV (Under insufficient voltage), TRQ (During torque limitation), IPS (During power failure deceleration), RNT (RUN time over), ONT (Power on time over), THM (Electronic thermal warning), THC (Electronic thermal warning), WAC (Capacitor life advance notice), WAF (Fan life advance notice), FR (Operation command signal), OHF (Cooling fin heating advance notice), LOC/LOC2 (Low-current signal), OL/OL2 (Overload advance notice), BRK (Brake release), BER (Brake abnormality), ZS (Zero-speed detection signal), OD/OD2 (PID deviation excessive), FBV/FBV2 (PID feedback comparison), NDc (Communication disconnection), Ai1Dc/Ai2Dc/Ai3Dc (Analog disconnection Ai1/Ai2/Ai3), WCAi1/WCAi2/WCAi3 (Window comparator Ai1/Ai2/Ai3), LOG1-7 (Logical operation result 1-7), MO1-7 (General output 1-7), OVS (Receiving overvoltage) and others described in "12.25.1 Using the output signal function externally".	
	EDM output terminal	Output for STO diagnosis	
	Monitor output terminal *8)	Possible to output through selection from monitor data of parameters	
EMC filter switching *9)		Possible to enable the EMC noise filter (switching method is different depending on the model)	
External access to PC		USB Micro-B	
Use environment	Ambient temperature *14)	ND (normal duty)	-10~50°C
		LD (low duty)	-10~45°C
		VLD (very low duty)	-10~40°C
	Storage temperature *10)	-20~65°C	
	Humidity	20-90%RH (location free of condensation)	
	Vibration *11)	5.9m/s <sup>2</sup> (0.6G), 10~55Hz	
Use location *12)	1000 altitude or lower (location free from corrosive gas, oil mist, and dust)		
Consumable components	Designed life of main circuit smoothing capacitor 10 years		
	Designed life of cooling fan 10 years (models equipped with a cooling fan) free from dust		
	Memory element on the control circuit board		
Applicable standards *13)		Compliance with UL/cUL/CE standards, RCM, Functional Safety SIL3/PLe (to be obtained)	
Painting color		Black	
Number of option slots		3 ports	
Option	I/O option	Analog I/O option	
	Communication option *15)	Ethernet(Modbus-TCP), EtherCAT, PROFINET	
	Feedback option	For line driver	
	Function safety option	Function safety option	
Other options		Braking resistor, AC reactor, DC reactor, noise filter, cables for each operator Harmonic suppression unit, noise filter, LCR filter, analog control panel, regenerative braking unit, power supply regenerative converter, applied control devices Computer software ProDriveNext, relay extension terminal board, SJ300/SJ700 terminal connection board	

\*7) The threshold for signal output varies depending on the motor to be combined with the inverter, parameter adjustment, etc.

\*8) The output data of analog voltage monitor and analog current monitor are reference values for connecting an analog meter. Due to the meter to be connected and variation in analog output circuit, the maximum output value may slightly vary from 10V or 20mA. To change characteristics, make adjustments using the Ao1 adjustment and Ao2 adjustment functions. Some monitor data cannot be output.

\*9) To enable the EMC filter, connect with a power supply grounded at a neutral point. Otherwise, the leakage current may increase.

\*10) The storage temperature is the temperature during transport.

\*11) To be in accordance with the testing method specified in JIS C 60068-2-6: 2010 (IEC 60068-2-6:2007)

\*12) When the inverter is used in a location at 1000m or higher altitude, air pressure reduces approximately 1% every 100m elevation. Perform 1% current derating and conduct evaluation for every 100m elevation. Please contact us for use in 2500m or higher environments.

\*13) For insulation distance, comply with UL and CE standards

\*14) Use the 400V class inverter at an input voltage of 500VAC or below. If input voltage exceeds 500VAC due to fluctuation of power, use the inverter at 40°C or lower ambient temperature.

\*15)

- EtherCAT<sup>®</sup> is a patented technology and registered trademark licensed by a German company Beckhoff Automation GmbH.

- PROFINET<sup>®</sup> is a registered trade mark of PROFIBUS Nutzerorganisation e.V. (PNO).

- Ethernet<sup>®</sup> is a registered trademark of Fuji Xerox Co., Ltd.

20.3 External dimensions

Model P1-****-* (P1-****)			
200 V class: 00044-L (004L), 00080-L (007L), 00104-L (015L), 00156-L (022L), 00228-L (037L)			
400V class: 00041-H (007H), 00054-H (015H), 00083-H (022H), 00126-H (037H)			
Dimension	W (mm)	H (mm)	D (mm)
	150	255	140

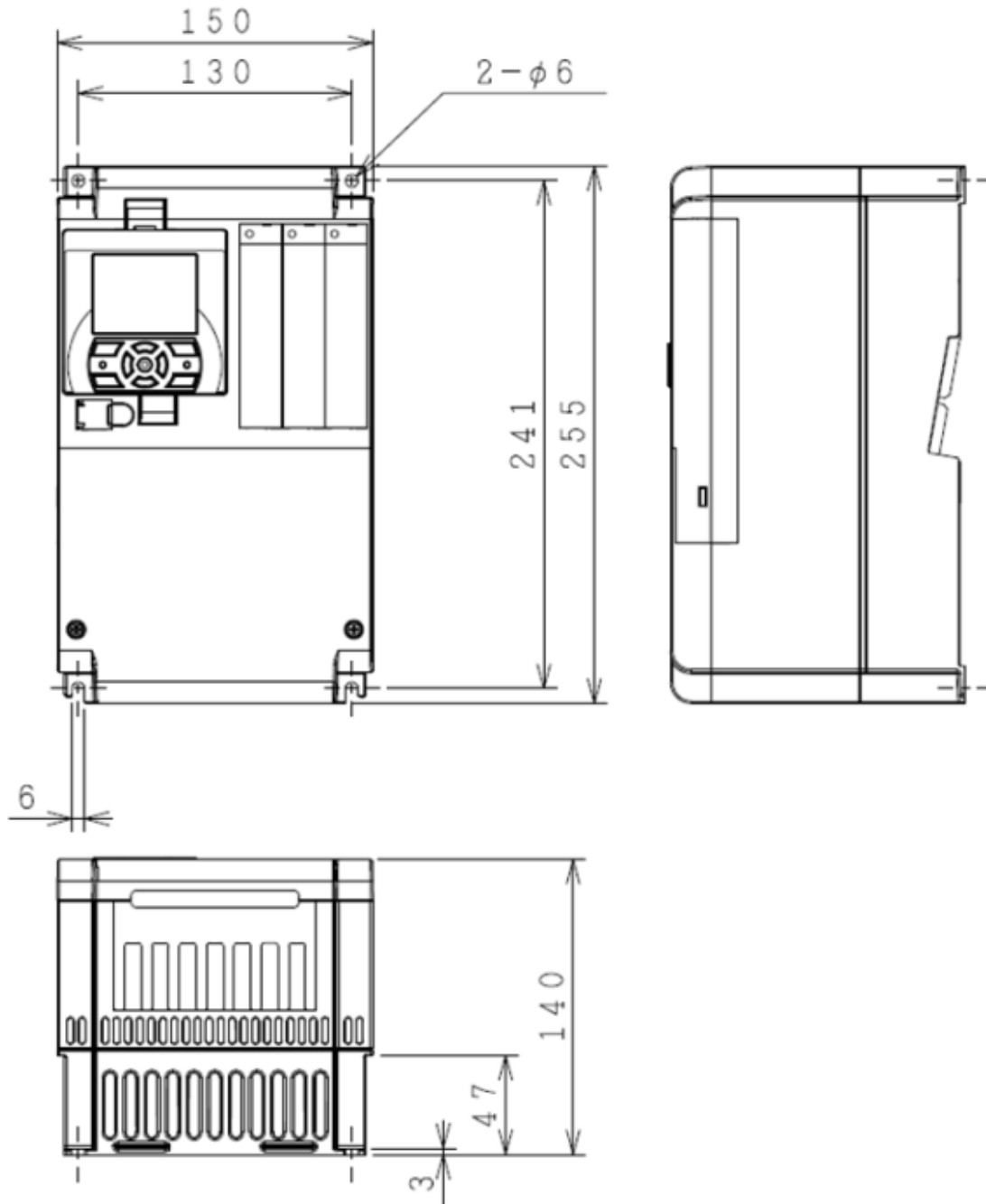



Model (P1-****)			
200V class: 00330-L (055L)/00460-L (075L)/00600-L (110L)/			
400V class: 00175-H (055H)/00250-H (075H)/00310-H (110H)			
Dimension	W (mm)	H (mm)	D (mm)
	210	260	170

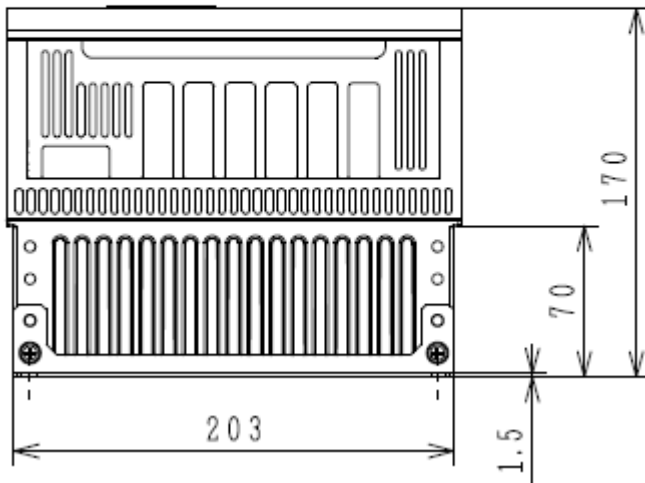
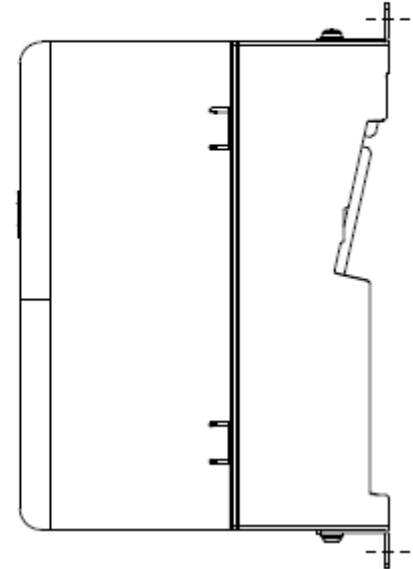
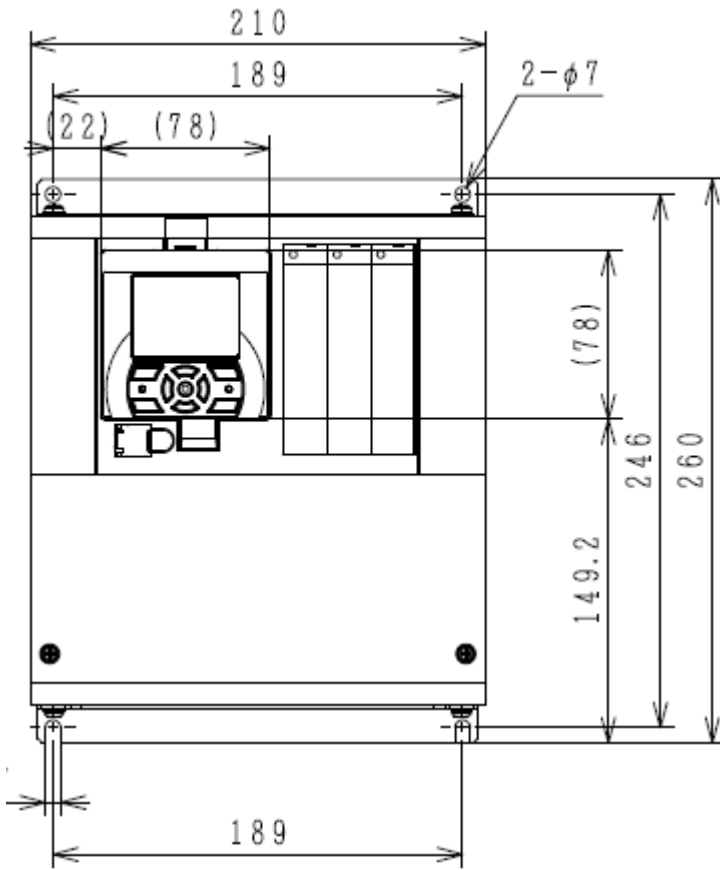

Model (P1-****)			
200V class: 00800-L (150L)/00930-L (185L)/01240-L (220L)			
400V class: 00400-H (150H)/00470-H (185H)/00620-H (220H)			
Dimension	W (mm)	H (mm)	D (mm)
	245	390	190

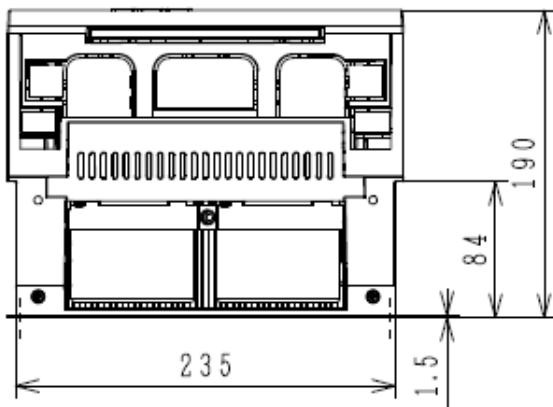
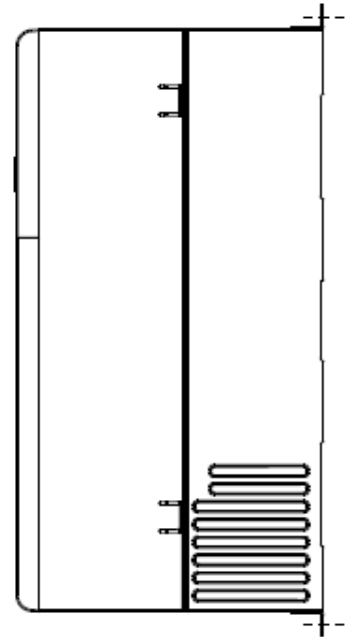
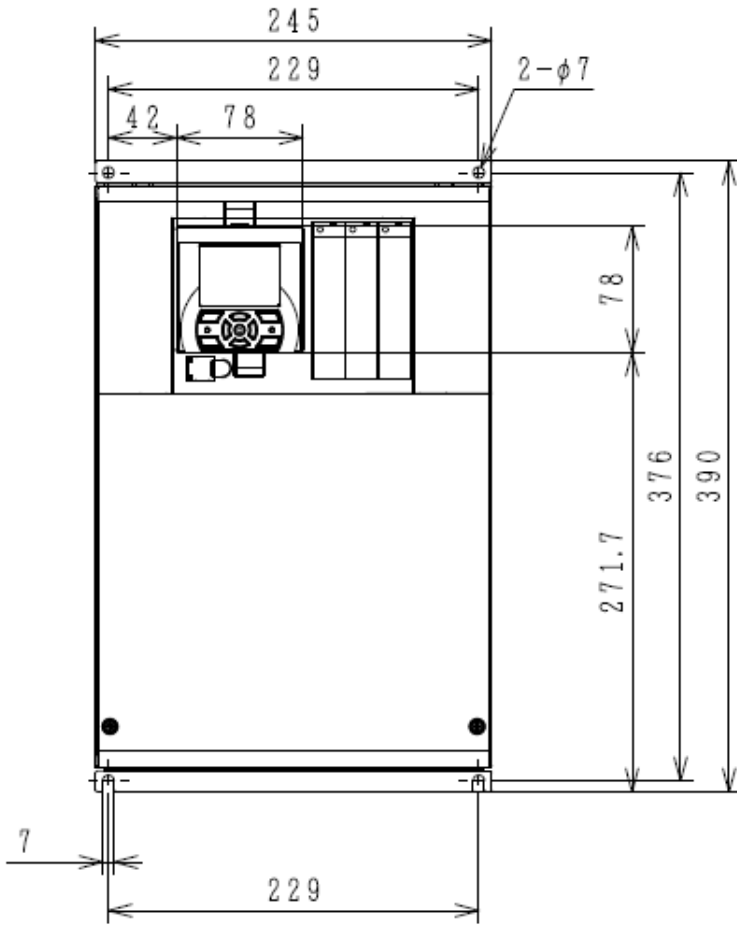

Model P1-*****(P1-****)			
200V class: 01530-L (300L)			
400V class: 00770-H (300H)			
Dimension	W (mm)	H (mm)	D (mm)
	540	300	195

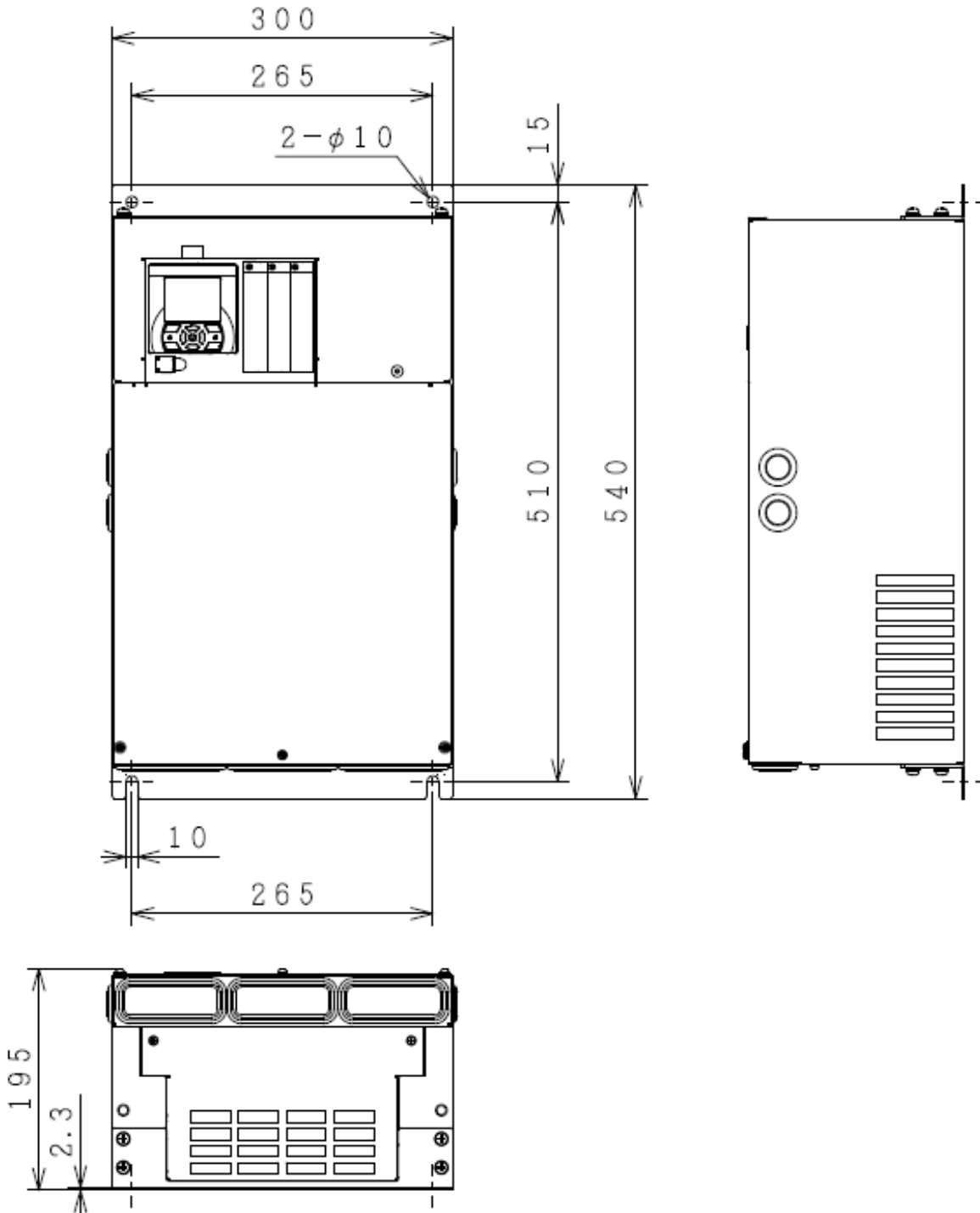

Model P1-****-* (P1-****)			
200V class: 01850-L (370L), 02290-L (450L)			
400V class: 00930-H (370H), 01160-H (450H), 01470-H (550H)			
Dimension	W (mm)	H (mm)	D (mm)
	550	390	250

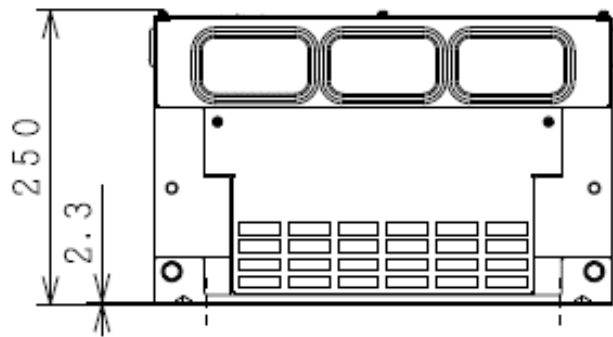
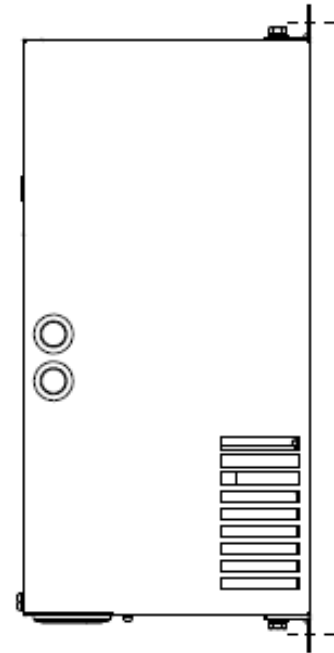
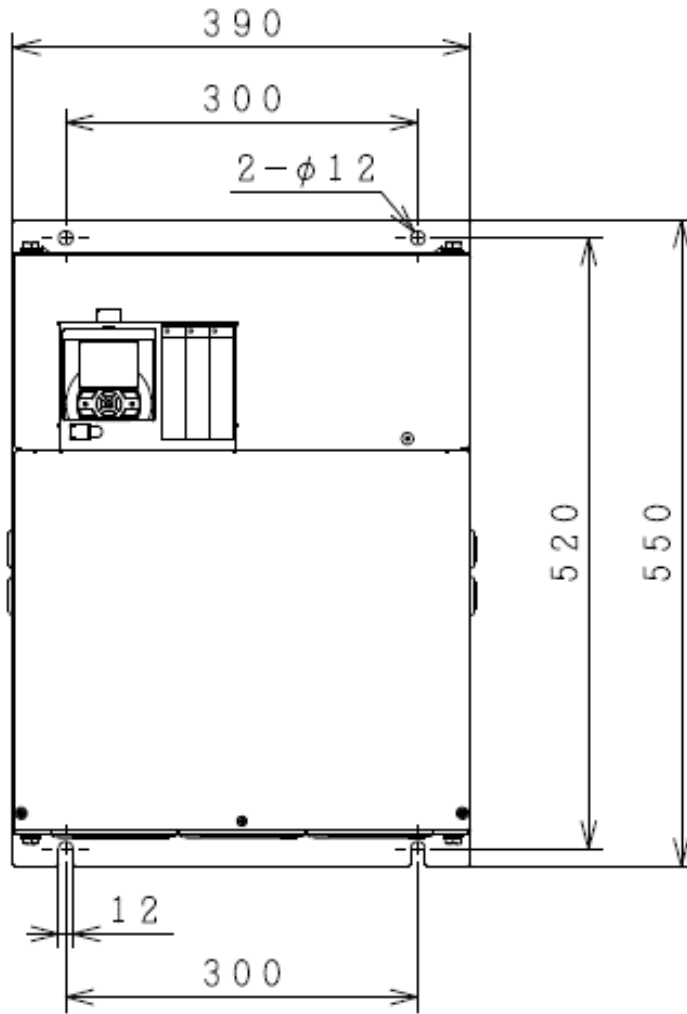

<b>Model P1-****-* (P1-****)</b>			
200V class: 02950-L (550L)			
Dimension	W (mm)	H (mm)	D (mm)
	700	480	250

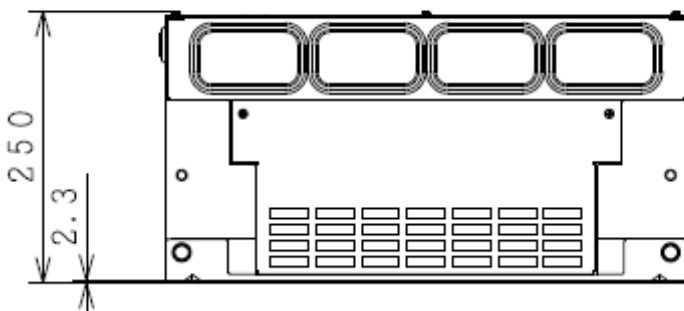
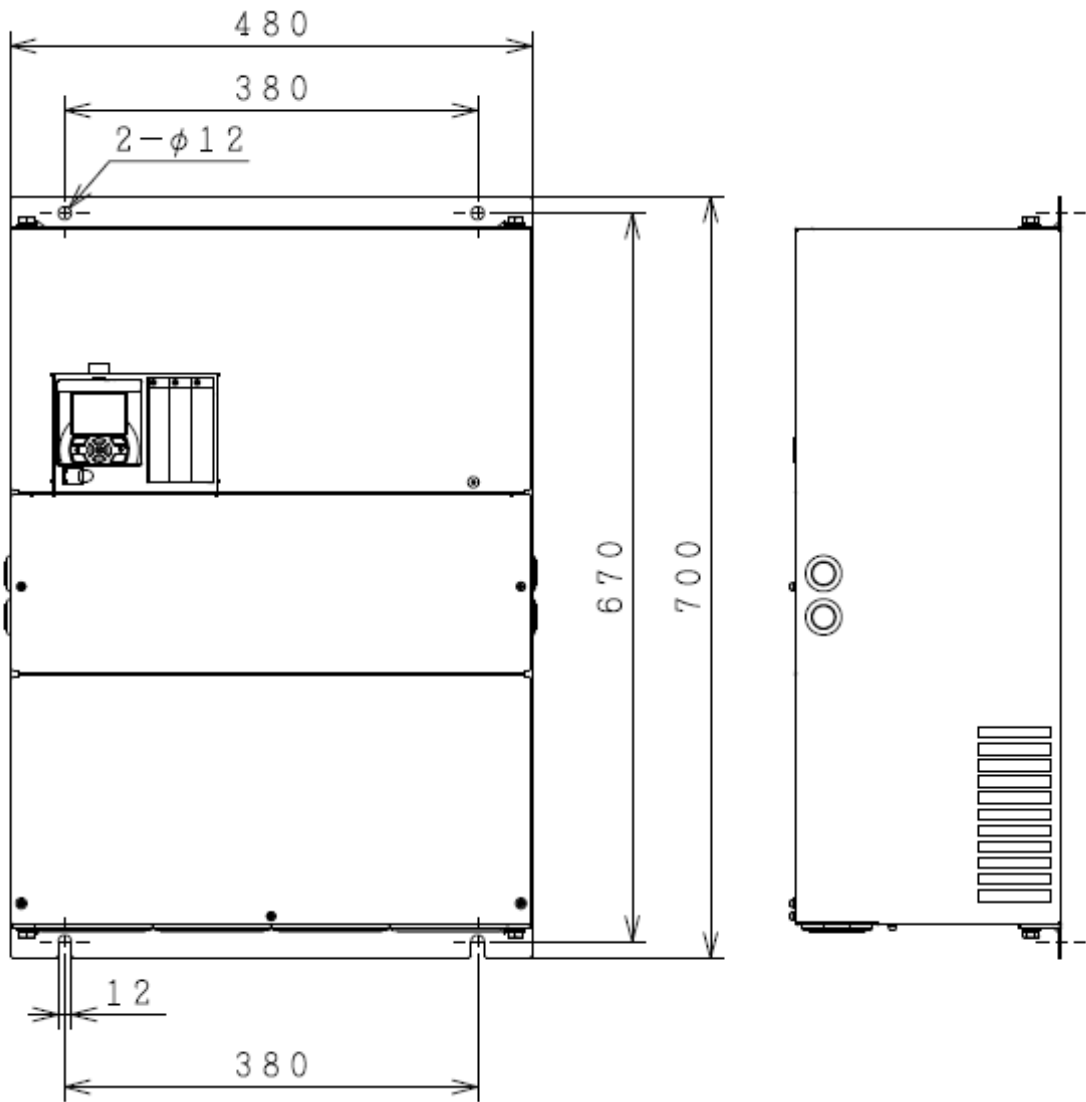

<b>Model P1-****-* (P1-****)</b>			
400V class: 01760-H (750H), 02130-H (900H)			
Dimension	W (mm)	H (mm)	D (mm)
	390	700	270

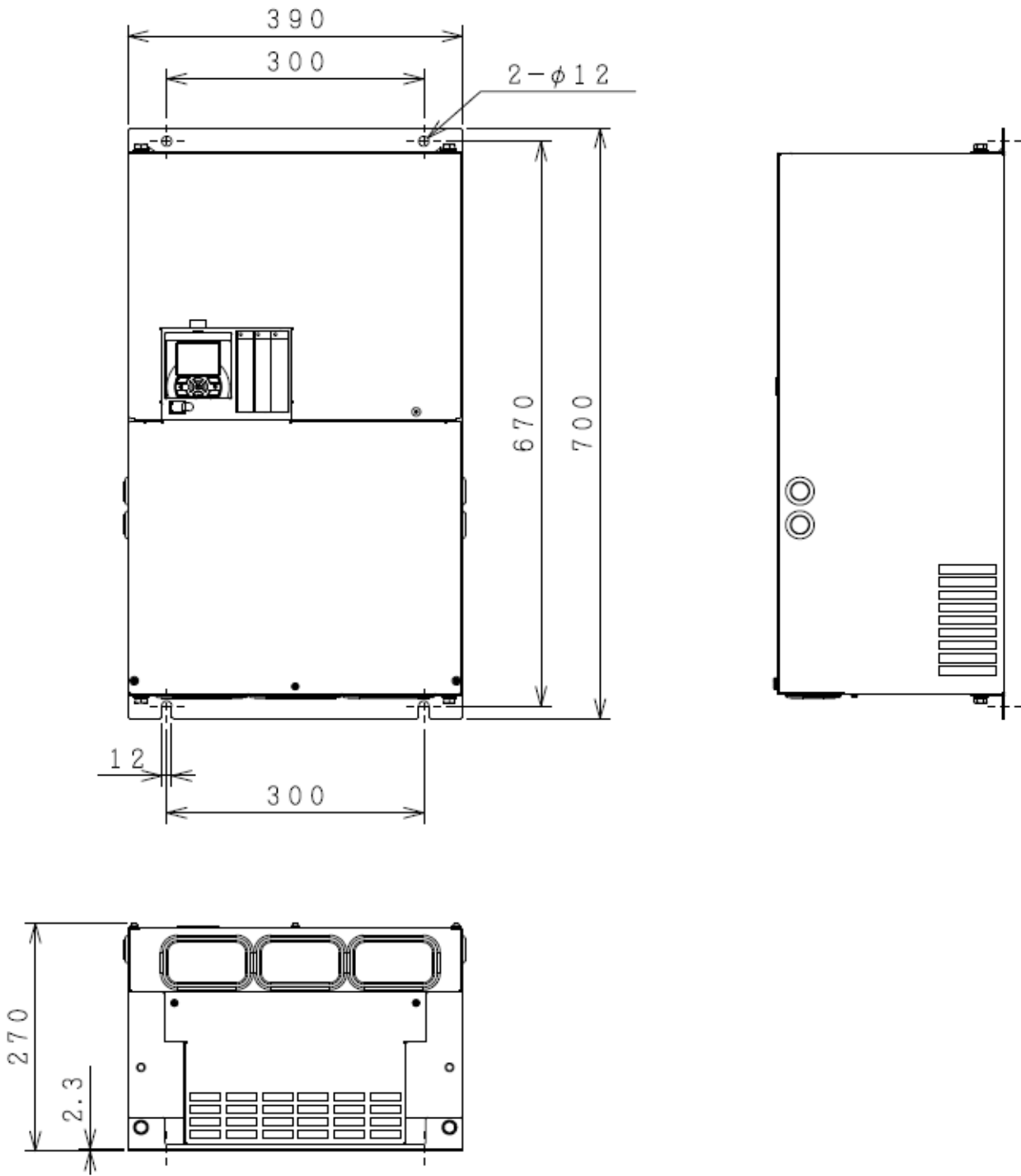

Model P1-****-* (P1-****)			
400V class: 02520-H (1100H), 03160-H (1320H)			
Dimension	W (mm)	H (mm)	D (mm)
	480	740	270

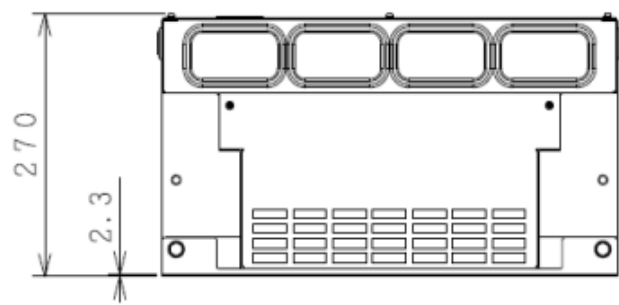
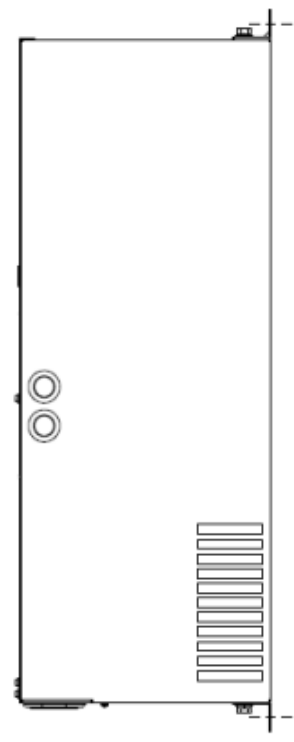
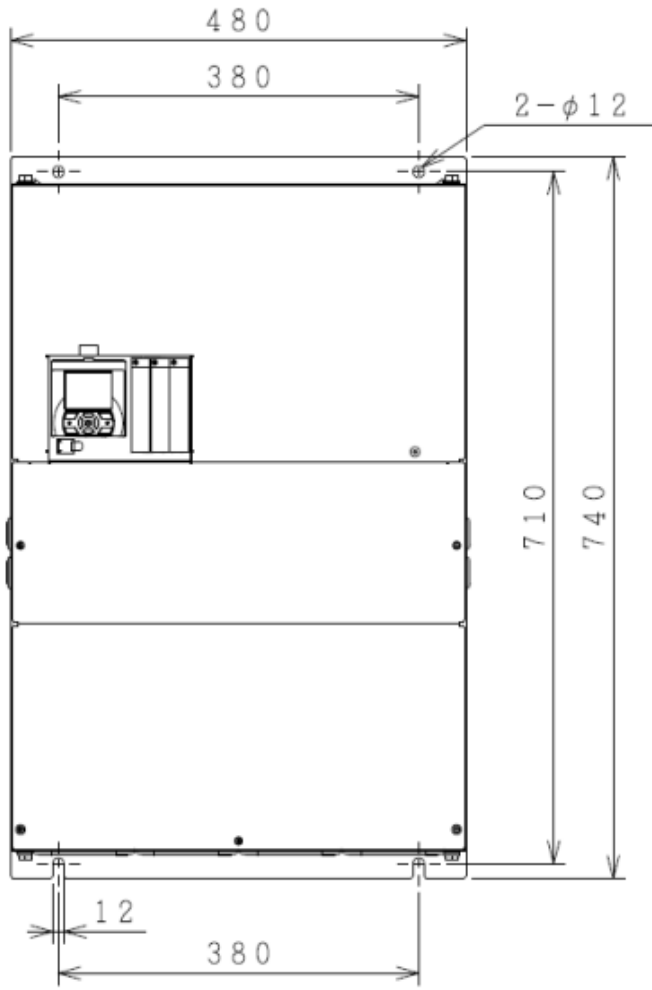

## 20.4 Current Derating Table



Caution

Please use the inverter within the current range in accordance with the derating tables of respective models. If you use the inverter exceeding the derating range, note that the inverter may be damaged or its life may be shortened.

### 20.4.1 200V class

#### ■ P1-00044-L (P1-004L)

Derating is not required.

#### ■ P1-00080-L (P1-007L)

Derating is not required.

#### ■ P1-00104-L (P1-015L)

Derating is not required.

#### ■ P1-00156-L (P1-022L)

Derating is not required.

#### ■ P1-00228-L (P1-037L)

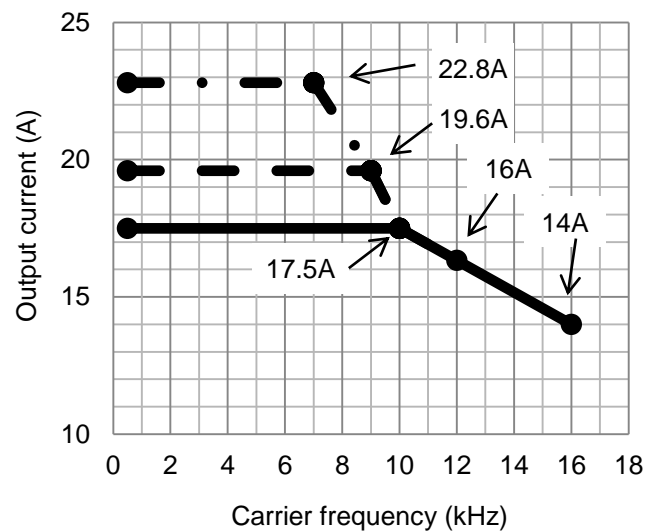



- — ● 50°C: ND rating (normal duty rating)
- - - - ● 45°C: LD rating (low duty rating)
- · - · ● 40°C: VLD rating (very low duty)

■ P1-00340-L (P1-055L)

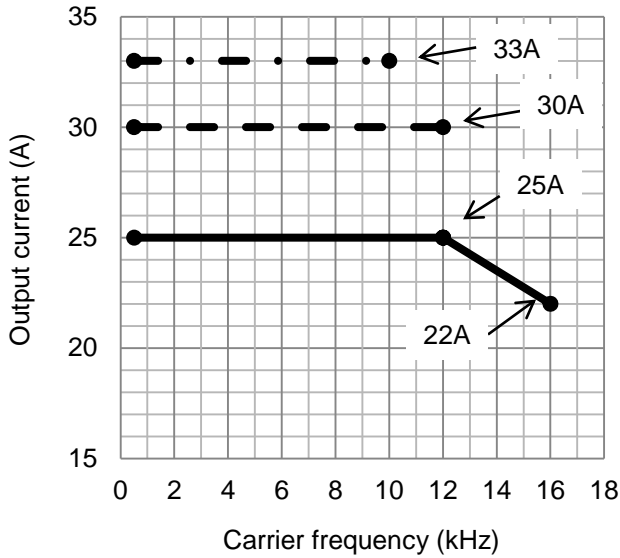

■ P1-00490-L (P1-075L)

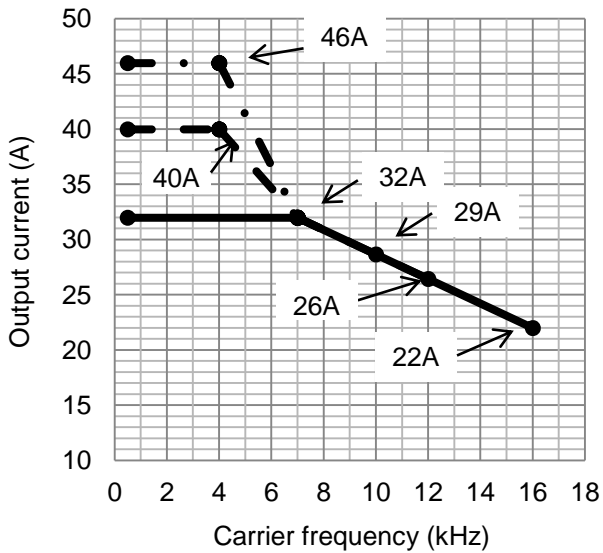

■ P1-00630-L (P1-110L)

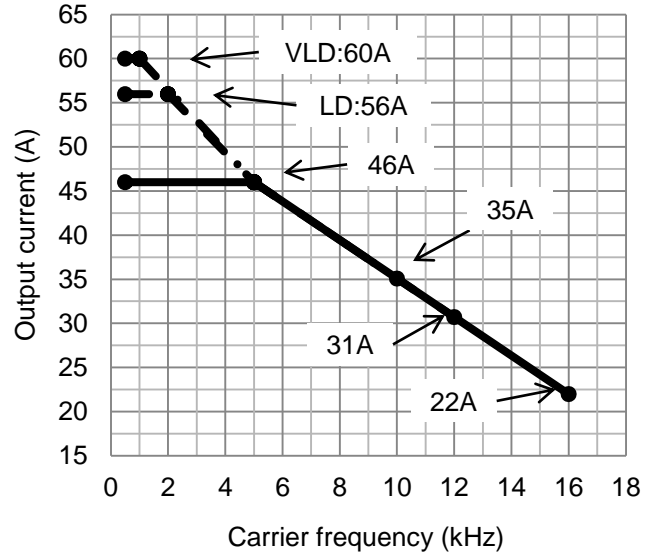

When using P1-00630-L (P1-110L) at LD (low duty rating) / VLD (very low duty rating), care must be taken for installation. See notes described in "6.3 External Dimensions".

■ P1-00800-L (P1-150L)

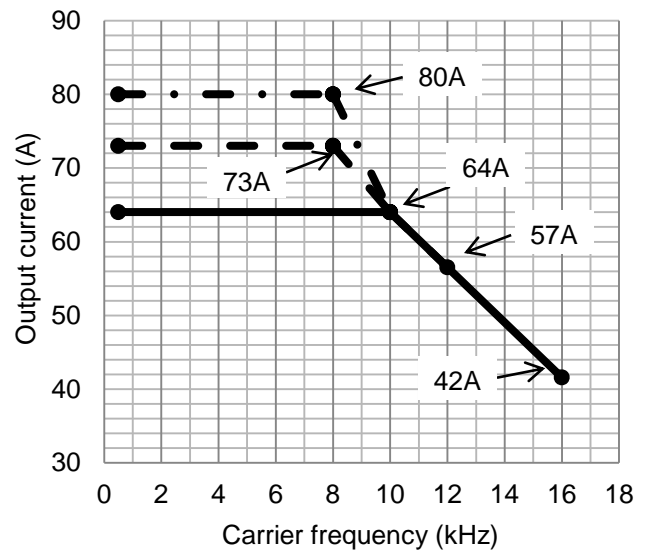

- 50°C: ND rating (normal duty rating)
- - -● 45°C: LD rating (low duty rating)
- · - ·● 40°C: VLD rating (very low duty)

■P1-00930-L (P1-185L)

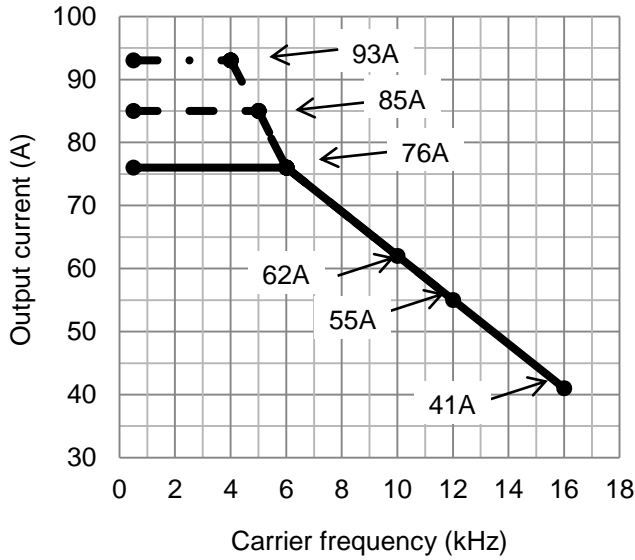

■P1-01530-L (P1-300L)

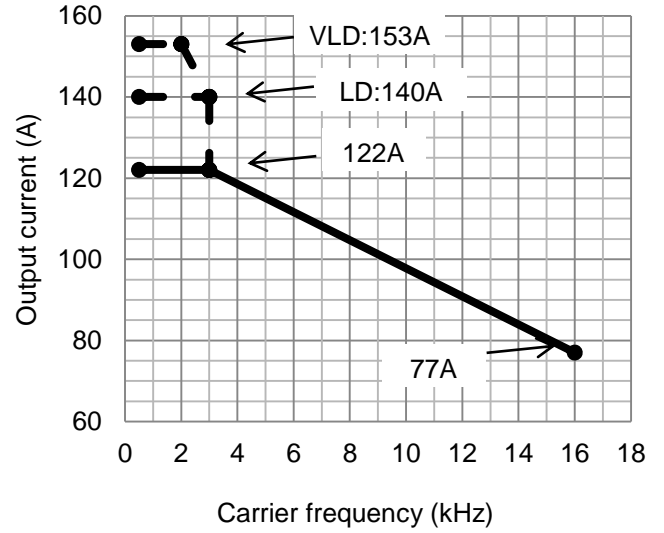

■P1-01240-L (P1-220L)

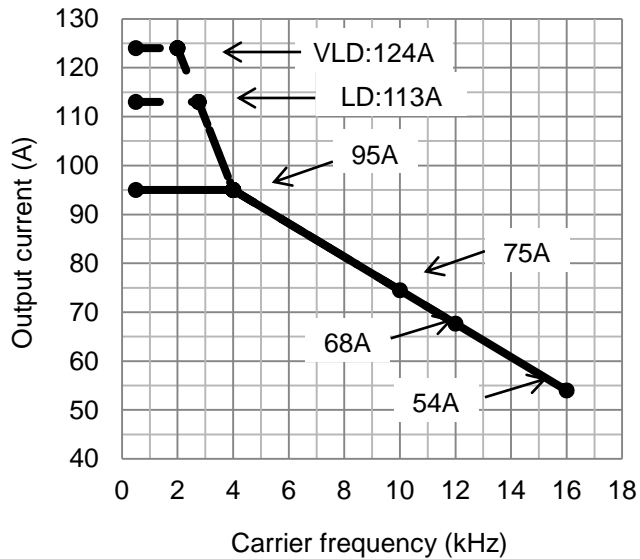

■P1-01850-L (P1-370L)

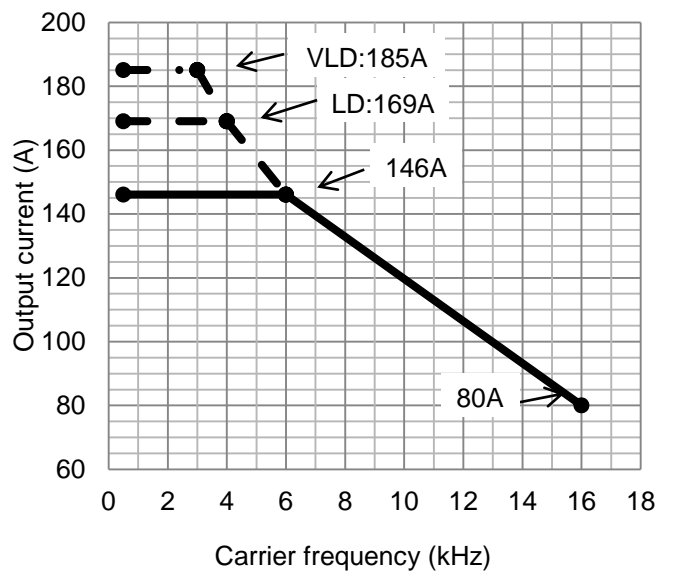

When using P1-01240-L (P1-220L) at VLD (very low duty rating), care must be taken for installation. See notes described in "6.3 External Dimensions".

- 50°C: ND rating (normal duty rating)
- - -● 45°C: LD rating (low duty rating)
- · - ·● 40°C: VLD rating (very low duty)

**20.4.2** 400V class

■P1-02290-L (P1-450L)

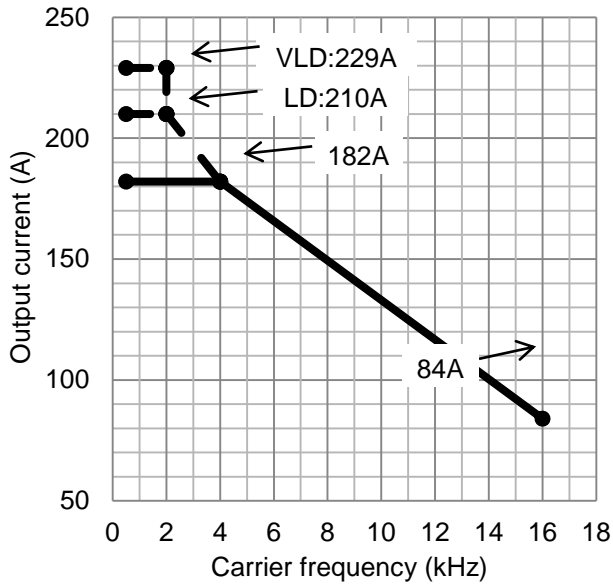

■P1-02950-L (P1-550L)

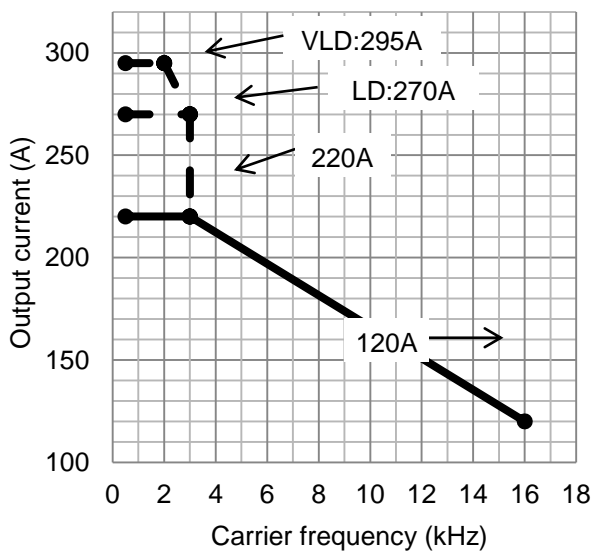

■P1-00041-H (P1-007H)

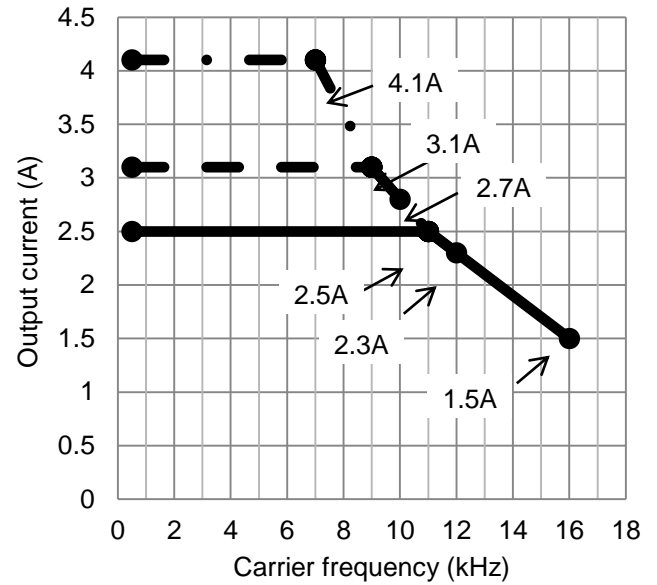

■P1-00054-H (P1-015H)

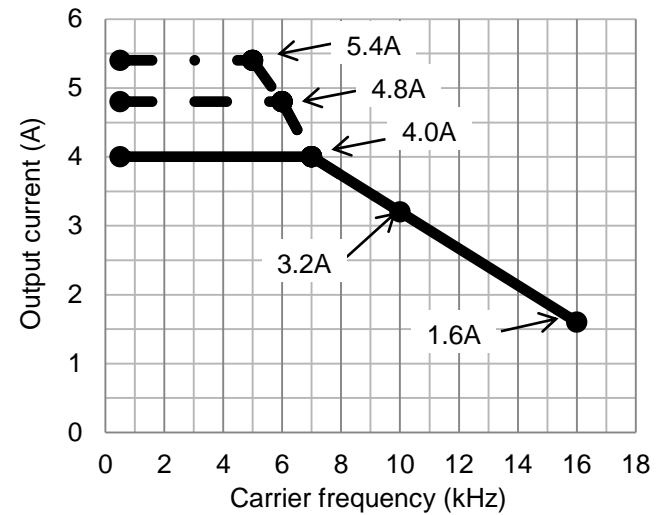

■P1-00083-H (P1-022H)

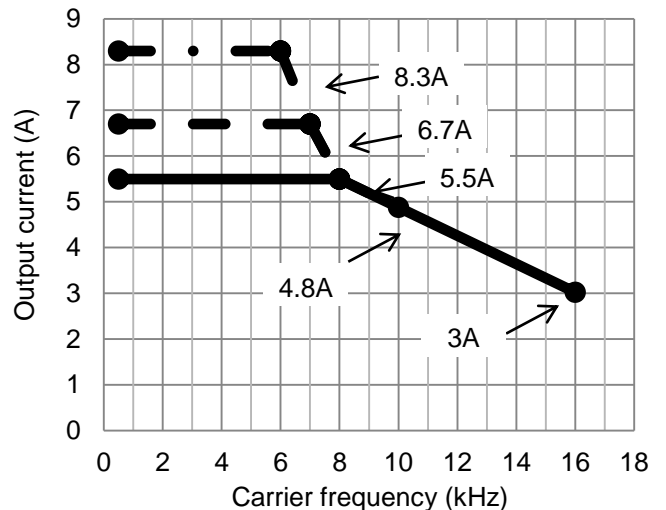

- 50°C: ND rating (normal duty rating)
- - -● 45°C: LD rating (low duty rating)
- · ·● 40°C: VLD rating (very low duty)

■P1-00126-H (P1-037H)

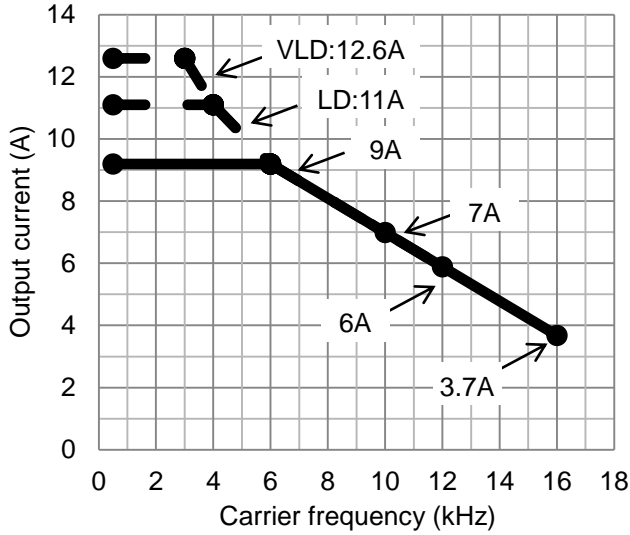

■P1-00250-H (P1-075H)

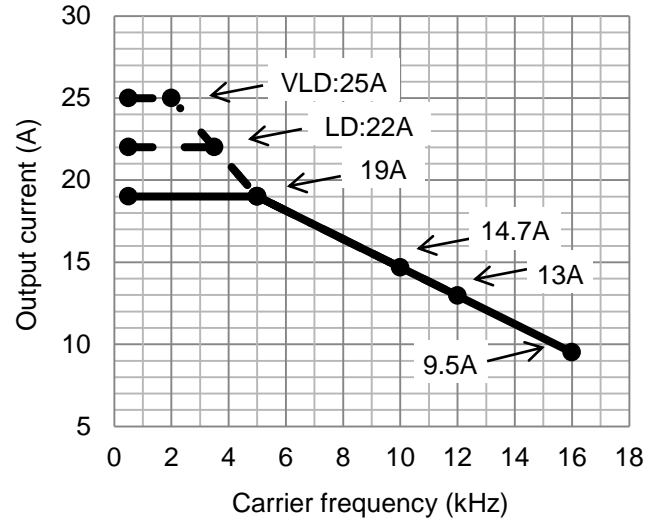

■P1-00175-H (P1-055H)

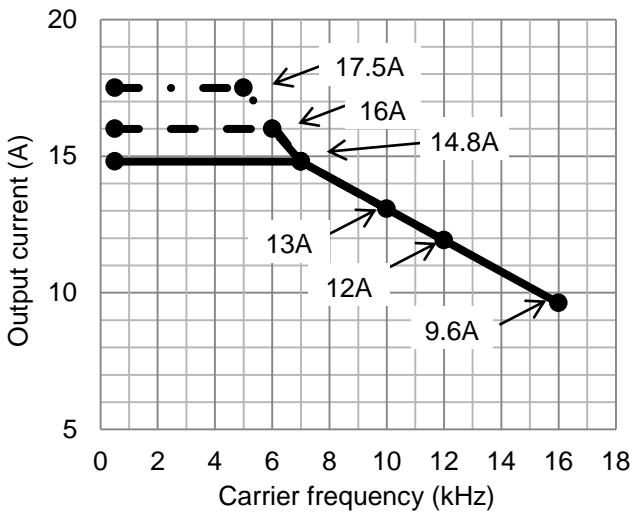

■P1-00310-H (P1-110H)

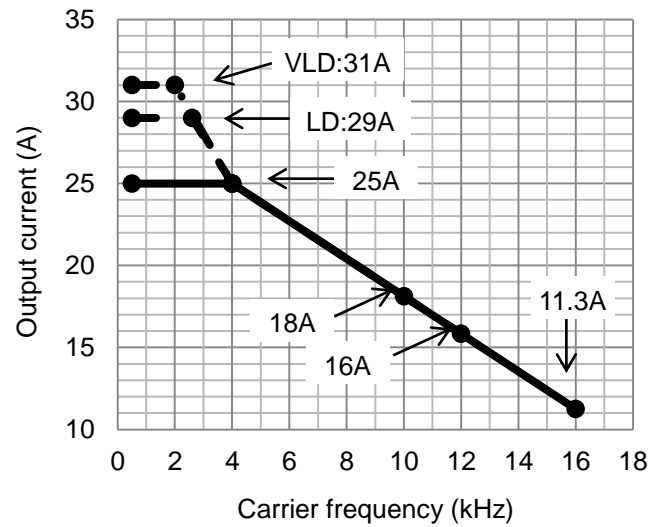

- 50°C: ND rating (normal duty rating)
- - -● 45°C: LD rating (low duty rating)
- · - ·● 40°C: VLD rating (very low duty)

■P1-00400-H (P1-150H)

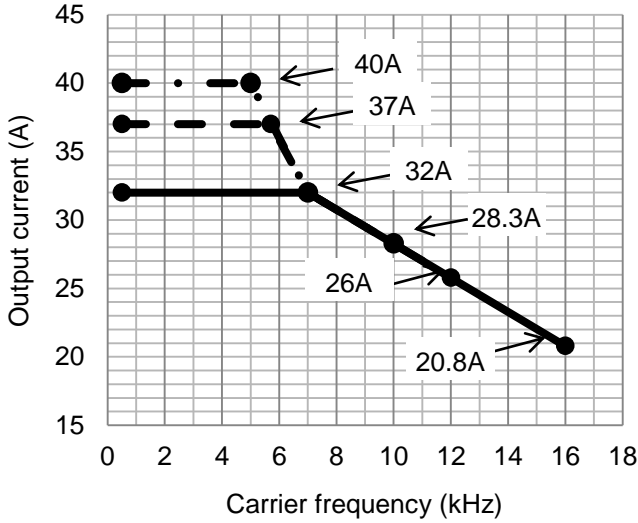

■P1-00470-H (P1-185H)

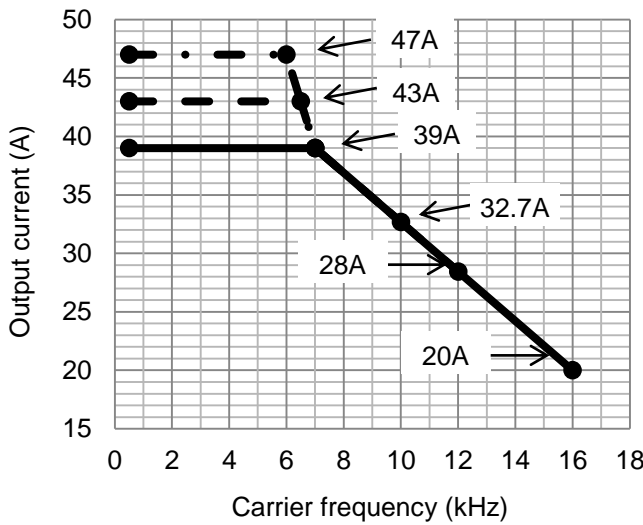

■P1-00620-H (P1-220H)

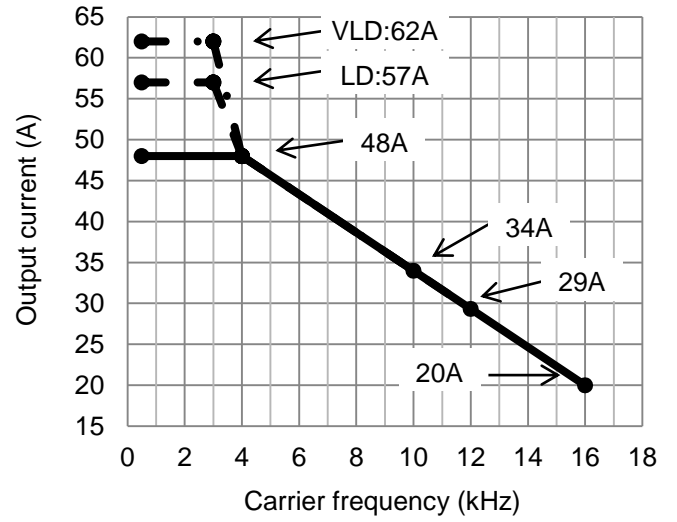

■P1-00770-H (P1-300H)

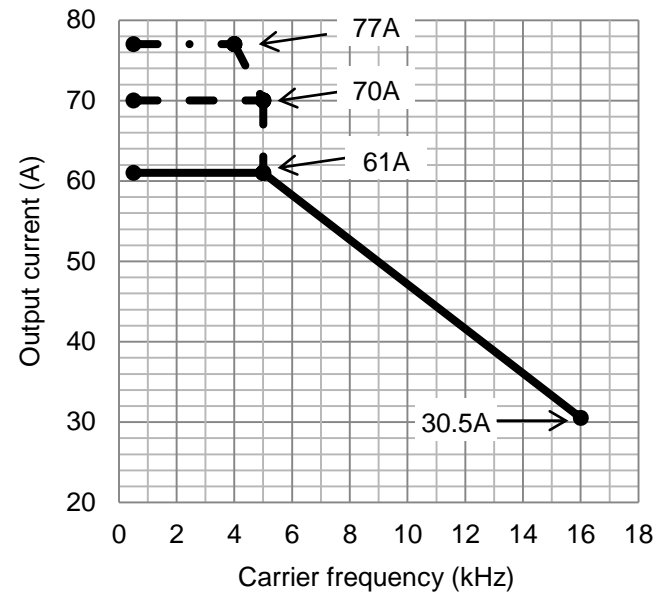

■P1-00930-H (P1-370H)

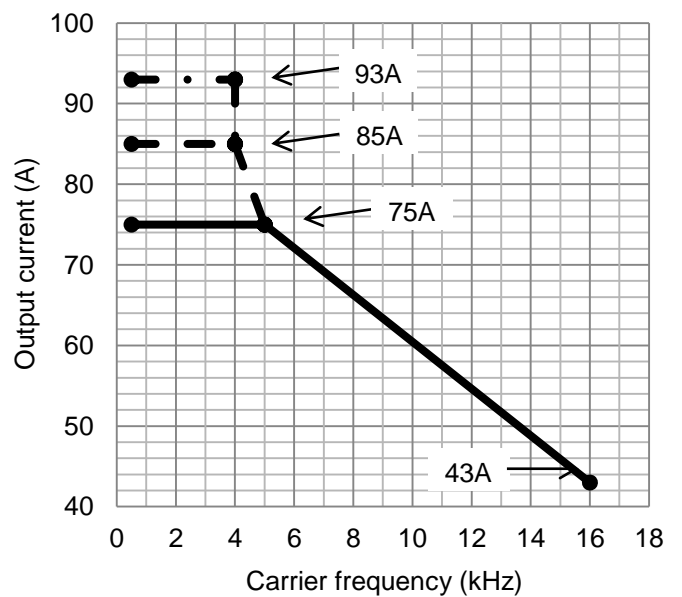

\* Please contact us for use of the following models.

■ P1-01160-H (P1-450H)

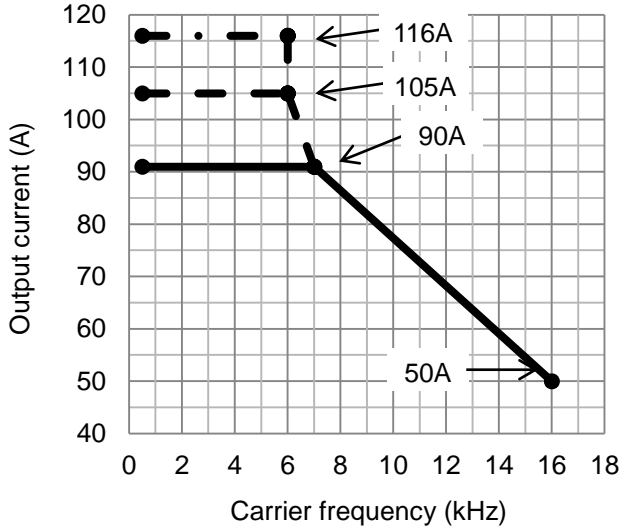

■ P1-01760-H (P1-750H)

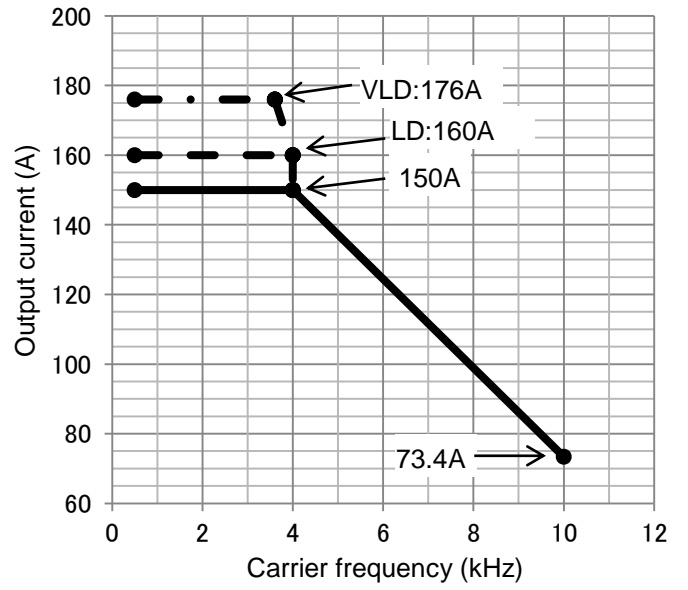

■ P1-01470-H (P1-550H)

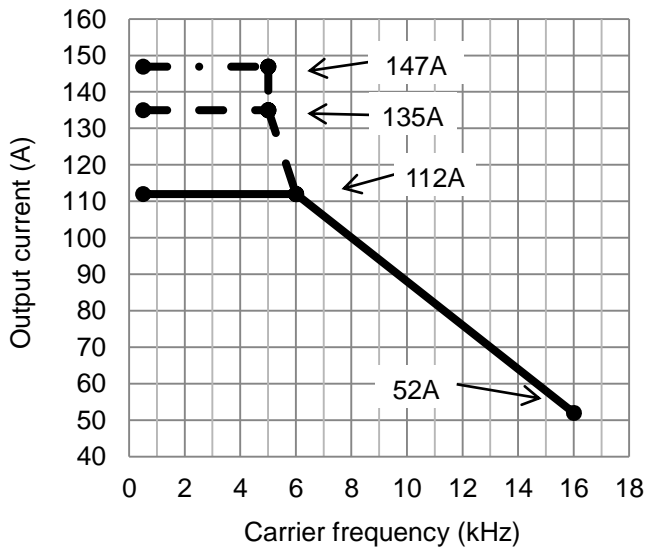

■ P1-02130-H (P1-900H)

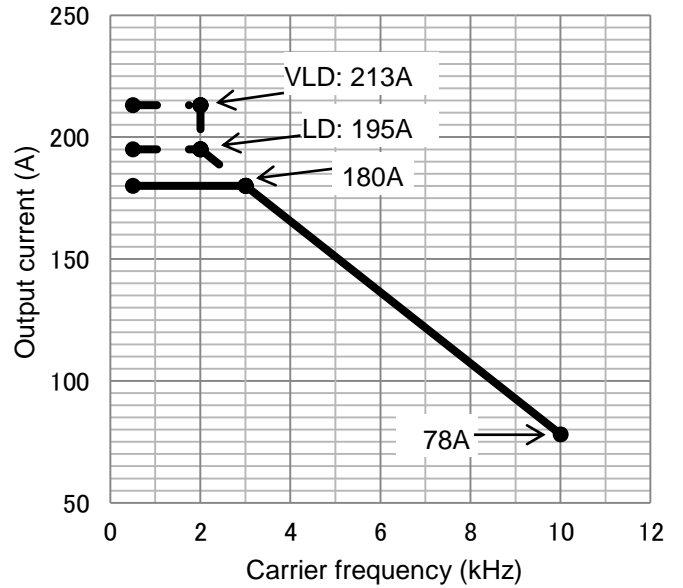

■ P1-02520-H (P1-1100H)

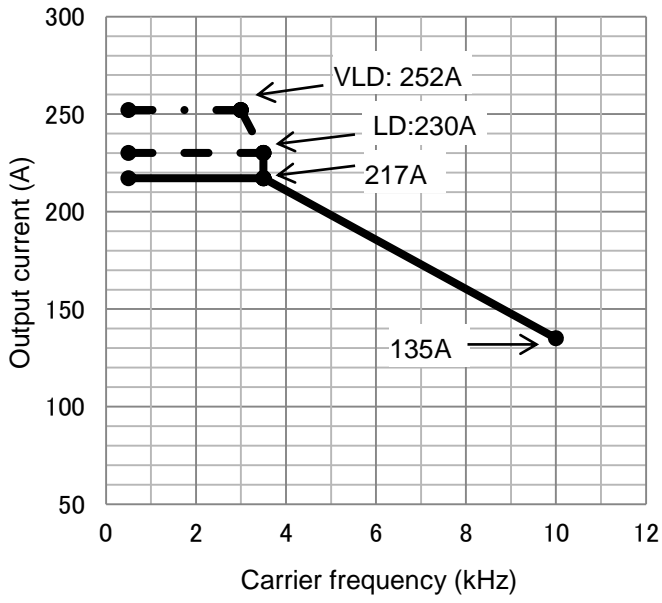

■ P1-03160-H (P1-1320H)

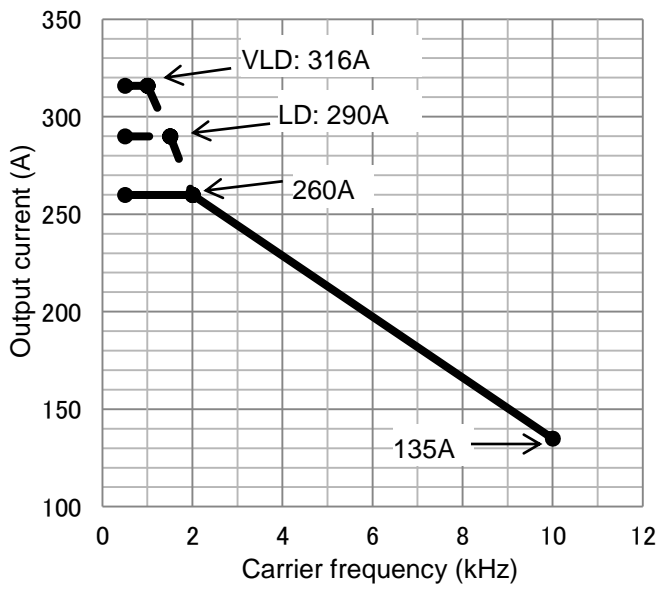

# Appendix List of Parameters

## Contents

A1.1 What This Chapter Explains.....	Appendix 1-1
A1.2 How to View Parameters and Lists..	Appendix 1-1
A1.3 List of Monitor Modes.....	Appendix 1-3
A1.4 List of Parameter Modes .....	Appendix 1-8

## A1.1 What This Chapter Explains

This chapter describes lists of monitors and parameters as well as setting range of each parameter and their initial values.

## A1.2 How to View Parameters and Lists

### ■ Structure of parameter number

- A parameter consists of a parameter group, switch recognition number assigned by the 024[SET] terminal function, and an in-group number.
- If the switch recognition number assigned by 024[SET] terminal function is "-", it is enabled in both first setting and second setting.

- If the 024[SET] function is not set to the input terminal functions [CA-01] to [CA-11], the first setting is valid.

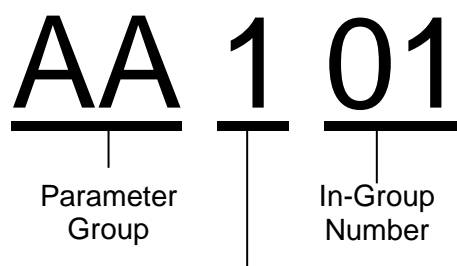

- : Always enabled in both the first setting and second setting
- 1: Enabled in the first setting when the [SET] terminal function is OFF
- 2: Enabled in the second setting when the [SET] terminal function is ON



■ About monitor mode

Code	Name	Data range	Page
<b>XX-01</b>	Monitor name	Data Range	Reference page

■ About parameter mode

Code	Name	Data range	Initial value	Note	Page
YY101	Parameter name	Data range	ZZ (*FF)/ UU (*FEF) (*FUF) (*FCF)	(Write down the setting value)	Reference page
<u>YY-02</u>	Parameter name	(200V class) data range (400V class) data range	(200V class) VV (400V class) WW	(Write down the setting value)	Reference page

Codes that can be changed during operation are underlined.

- The voltage class is shown by 200V/400V.
- See "Chapter 20 Specifications" for the product model.  
The description applies to all models unless otherwise specified.
- If the initial value differs depending on the destination, symbols (JPN)/(EU · ASIA)/(USA)/(CHN) are separately described.  
If there is no description, the initial value is the same for all destinations.
- Models correspond with the following destinations.
  - P1-\*\*\*\*-\*FF (\*FF):(JPN)
  - P1-\*\*\*\*-\*FEF (\*FEF):(EU, ASIA)
  - P1-\*\*\*\*-\*FUF (\*FUF):(USA)
  - P1-\*\*\*\*-\*FCF (\*FCF):(CHN)
- \* Parameters other than those changeable during operation can be changed only when the device is stopped. The user can change the parameter that cannot be changed during operation after the device decelerates and stops and output is stopped. However, it cannot be changed if the soft-lock function is activated.
- The text includes notes with a symbol “\*”).

■ Notes on setting parameters



**Do**

- When setting parameters, we expect you to fully understand various points to be noted.
- Make sure to check and set the following parameters to protect the motor.
  - [Hb102]-[Hb108] (for IM)
  - [Hd102]-[Hd108] (for SM/PMM)
  - [bC110] (electronic thermal level)
    - for motor overload protection current
  - [bb160] (overcurrent level)
- \* When setting the thermal subtraction characteristics, set a value in accordance with the characteristics of motor. Otherwise, the motor may be burned.

- After configuring settings for motor protection, choose the frequency command destination and operation command destination to run the device.
- With [AA101], choose a frequency command destination.
  - With [AA111], choose an operation command destination.
  - With [FA-01], check that the frequency command is received.
- \*) To run the inverter, a frequency command and operation command are required. If commands are sent using V/f control, there is no output if the frequency command is 0Hz.

## A1.3 List of Monitor Modes

### ■ Monitors related to output

Code	Name	Data range	Page
dA-01	Output frequency monitor	0.00~590.00 (Hz)	13-2
dA-02	Output current monitor	0.0~655.35 (A)	13-9
dA-03	Operation direction monitor	F (Normal rotation in process)/ r (Reverse rotation in process)/ d (0Hz output)/ o (Stopped)	13-7
dA-04	Frequency command	-590.00~590.00 (Hz)	13-3
dA-06	Output frequency conversion monitor	0.00~59000.00 (Hz)	13-4
dA-08	Speed detection value monitor	-590.00~590.00 (Hz)	13-5
dA-12	Output frequency monitor (with sign)	-590.00~590.00 (Hz)	13-2
dA-14	Frequency upper limit monitor	0.00~590.00 (Hz)	
dA-15	Torque command monitor (after calculation)	-1000.0~1000.0 (%)	13-28
dA-16	Torque limit monitor	0.0~500.0 (%)	12-11-9
dA-17	Output torque monitor	-1000.0~1000.0 (%)	13-28
dA-18	Output voltage monitor	0.0~800.0 (V)	13-10
dA-20	Current position monitor	When [AA121]≠10 or [AA123]≠03 -268435455~+268435455 (pls)/ When [AA121]=10 and [AA123]=03 -1073741823~+1073741823 (pls)	12-11-5
dA-26	Pulse string position deviation monitor	-2147483647~+2147483647 (pls)	12-17-18
dA-28	Pulse counter monitor	0~2147483647 (pls)	
dA-30	Input power monitor	0.00~600.00 (kW)	13-14
dA-32	Integrated input power monitor	0.0~1000000.0 (kW)	13-14
dA-34	Output power monitor	0.00~600.00 (kW)	13-15
dA-36	Integrated output power monitor	0.0~1000000.0 (kW)	13-15
dA-38	Motor temperature monitor	-20.0~200.0 (°C)	
dA-40	DC voltage monitor	0.0~1000.0 (V)	13-10
dA-41	Braking resistor circuit (BRD) duty ratio monitor	0.00~100.00 (%)	13-19
dA-42	Electronic thermal duty ratio monitor (motor)	0.00~100.00 (%)	13-18
dA-43	Electronic thermal duty ratio monitor (controller (inverter))	0.00~100.00 (%)	13-18

■ Monitors related to control circuit

Code	Name	Data range	Page
dA-45	STO monitor	00 (no input)/ 01 (P-1A)/ 02 (P-2A)/ 03 (P-1b)/04 (P-2b)/05 (P-1C)/ 06 (P-2C)/ 07 (STO)	21-30
dA-46	P1-FS hardware monitor	0000~FFFF	-
dA-47	P1-FS function monitor	00 (no input)/ 01 (STO)/ 02 (SBC)/ 03 (SS1)/04 (SLS)/05 (SDI)/ 06 (SSM)	-
dA-50	Terminal block option mounted	00 (P1-TM: standard terminal block)/ 02 (P1-TM2: terminal block with round screws)/15 (not connected)	13-27
dA-51	Input terminal monitor	LLLLLLLLLLLL~HHHHHHHHHHH [L:OFF/H:ON] [Left side] (terminal B) (terminal A) (terminal 9) - (terminal 1) [Right side]	13-8
dA-54	Output terminal monitor	LLLLLLL~HHHHHHH [L:OFF/H:ON] [Left side] (terminal AL) (terminal 16C) (terminal 15) - (terminal 11) [Right side]	13-8
dA-60	Analog I/O selection monitor	AAAAAAAA- VVVVVVVV [A: current/V: voltage] [Left side] (terminal Ao4 (Io4/Vo4)) (terminal Ao3 (Io3/Vo3)) (terminal Ai4 (Ii4/Vi4)) (terminal Ai3 (Ii3/Vi3)) (terminal Ao2) (terminal Ao1) (terminal Ai2) (terminal Ai1) [Right side]	13-21
dA-61	Analog input [Ai1] monitor	0.00~100.00 (%)	13-26
dA-62	Analog input [Ai2] monitor	0.00~100.00 (%)	
dA-63	Analog input [Ai3] monitor	-100.00~100.00 (%)	
dA-64	Extended analog input [Ai4] monitor	0.00~100.00 (%)	
dA-65	Extended analog input [Ai5] monitor	0.00~100.00 (%)	
dA-66	Extended analog input [Ai6] monitor	-100.00~100.00 (%)	
dA-70	Pulse string input monitor (main body)	-100.00~100.00 (%)	
dA-71	Pulse string input monitor (P1-FB)	-100.00~100.00 (%)	

■ Option slot monitor

Code	Name	Data range	Page
dA-81	Option slot 1 mounted	00: (none)/01: (P1-EN)/02: (P1-ECT)/ <hereafter only da-82 is indicated>33: (P1-FB)	13-20
dA-82	Option slot 2 mounted		
dA-83	Option slot 3 mounted		

## ■ Monitors related to the program function EzSQ

Code	Name	Data range	Page
db-01	Program download monitor	00 (Without a program)/01 (With a program)	16-5
db-02	Program number monitor	0000~9999	16-5
db-03	Program counter (Task-1)	1~1024	16-5
db-04	Program counter (Task-2)	1~1024	16-5
db-05	Program counter (Task-3)	1~1024	16-5
db-06	Program counter (Task-4)	1~1024	16-5
db-07	Program counter (Task-5)	1~1024	16-5
db-08	User monitor 0	-2147483647~2147483647	16-5
db-10	User monitor 1	-2147483647~2147483647	16-5
db-12	User monitor 2	-2147483647~2147483647	16-5
db-14	User monitor 3	-2147483647~2147483647	16-5
db-16	User monitor 4	-2147483647~2147483647	16-5
db-18	Analog output monitor YA0	0~10000	16-5
db-19	Analog output monitor YA1	0~10000	16-5
db-20	Analog output monitor YA2	0~10000	16-5
db-21	Analog output monitor YA3	0~10000	16-5
db-22	Analog output monitor YA4	0~10000	16-5
db-23	Analog output monitor YA5	0~10000	16-5

## ■ Monitors related to PID function

Code	Name	Data range	Page
db-30	PID1 feedback data 1 monitor	0.00~100.00 (%) (adjustable in [AH-04][AH-05][AH-06])	12-10-7
db-32	PID1 feedback data 2 monitor		
db-34	PID1 feedback data 3 monitor		
db-36	PID2 feedback data monitor	0.00~100.00 (%) (adjustable in [AJ-04][AJ-05][AJ-06])	12-10-25
db-38	PID3 feedback data monitor	0.00~100.00 (%) (adjustable in [AJ-24][AJ-25][AJ-26])	
db-40	PID4 feedback data monitor	0.00~100.00 (%) (adjustable in [AJ-44][AJ-45][AJ-46])	
db-42	PID1 target value monitor	0.00~100.00 (%) (adjustable in [AH-04][AH-05][AH-06])	
db-44	PID1 feedback data monitor	(adjustable in [AH-04][AH-05][AH-06])	12-10-7
db-50	PID1 output monitor	-100.00~100.00 (%)	
db-51	PID1 deviation monitor	-100.00~100.00 (%)	
db-52	PID1 deviation 1 monitor	-100.00~100.00 (%)	
db-53	PID1 deviation 2 monitor	-100.00~100.00 (%)	
db-54	PID1 deviation 3 monitor	-100.00~100.00 (%)	
db-55	PID2 output monitor	-100.00~100.00 (%)	
db-56	PID2 deviation monitor	-100.00~100.00 (%)	12-10-25
db-57	PID3 output monitor	-100.00~100.00 (%)	
db-58	PID3 deviation monitor	-100.00~100.00 (%)	
db-59	PID4 output monitor	-100.00~100.00 (%)	
db-60	PID4 deviation monitor	-100.00~100.00 (%)	12-10-7
db-61	PID current P gain monitor	0~100.00 (%)	
db-62	PID current I gain monitor	0.0~3600.0 (s)	
db-63	PID current D gain monitor	0.00~100.00 (s)	
db-64	PID feed-forward monitor	0.00~100.00 (%)	

## ■ Monitors for checking internal condition

Code	Name	Data range	Page
dC-01	Monitor for checking selection of inverter duty spec	00 (very low duty)/01 (low duty)/02 (normal duty)	13-22
dC-02	Rated current monitor	0.0~6553.5 (A)	13-22
dC-07	Main speed command destination monitor	00 (disabled)/01 (Ai1)/02 (Ai2)/03 (Ai3)/04 (Ai4)/05 (Ai5)/06 (Ai6)/07 (Multistage speed 0)/08 (auxiliary speed)/09 (Multistage speed 1)/10 (Multistage speed 2)/11 (Multistage speed 3)/12 (Multistage speed 4)/13 (Multistage speed 5)/14 (Multistage speed 6)/15 (Multistage speed 7)/16 (Multistage speed 8)/17 (Multistage speed 9)/18 (Multistage speed 10)/19 (Multistage speed 11)/20 (Multistage speed 12)/21 (Multistage speed 13)/22 (Multistage speed 14)/23 (Multistage speed 15)/24 (JG)/25 (RS485)/26 (Option 1)/27 (Option 2)/28 (Option 3)/29 (Pulse array (main unit))/30 (Pulse array (P1-FB))/31 (EzSQ)/32 (PID)/33 (QOP-VR)/34 (AHD retention speed)	13-23
dC-08	Auxiliary speed command destination monitor	30 (Pulse array (P1-FB))/31 (EzSQ)/32 (PID)/33 (QOP-VR)/34 (AHD retention speed)	13-23
dC-10	Operation command destination monitor	00 ([FW]/[RV] terminal)/01 (3 wire)/02 (RUN key on operator keypad)/03 (RS485 setting)/04 (Option 1)/05 (Option 2)/06 (Option 3)	13-23
dC-15	Cooling fin temperature monitor	-20.0~200.0 (°C)	13-13
dC-16	Life diagnostic monitor	LL - HH [L: normal/H: reduction of life] [Left side ] (FAN life) (lives of the capacitors on the circuit board) [Right side]	13-16
dC-20	Total start-up count	1 - 65535 (Counts)	13-12
dC-21	Power-on count	1 - 65535 (Counts)	13-12
dC-22	Cumulative operating hours monitor during RUN	1~1000000 (hr)	13-11
dC-24	Cumulative power-on time	1~1000000 (hr)	13-11
dC-26	Cumulative operating time of cooling fan	1~1000000 (hr)	13-17
dC-37	Detailed monitor for icon 2LIM	00 (Condition other than below)/01 (Overcurrent suppression in process)/02 (Overload being limited)/03 (Overvoltage suppression in process)/04 (Torque being limited)/05 (Upper/lower limit and jump frequency setting being limited)/06 (Setting of minimum frequency being limited)	13-25 18-31
dC-38	Detailed monitor for icon 2ALT	00 (Condition other than below)/01 (Overload advance notice)/02 (Motor thermal advance notice)/03 (Controller thermal advance notice)/04 (Motor overheat advance notice)	
dC-39	Detailed monitor for icon 2RETRY	00 (Condition other than below)/01 (Retry standby)/02 (Restart standby)	
dC-40	Detailed monitor for icon 2NRDY	00 (Preparation completed condition other than below IRDY=OFF)/01 (Trip occurred)/02 (Power supply abnormality)/03 (Resetting)/04 (STO)/05 (Standby)/06 (Data inconsistency Others (including no FB, consistency of settings of A and B phases, etc.))/07 (Sequence abnormality)/08 (Free run)/09 (Forced stop)	
dC-45	IM/SM (PMM) monitor	00 (Induction motor IM being selected)/01 (Synchronous motor SM (permanent magnet motor PMM) being selected)	12-9-1
dC-50	Firmware version monitor	0.000~99.255	-
dC-53	Firmware grade monitor	00 (Standard)	-
dE-50	Warning monitor	See the right section	18-33

■ Monitors and parameters for changing the current commands \*1)

Code	Name	Data range	Note	Page
<a href="#">FA-01</a>	Main speed command monitor	0.00~590.00 (Hz)		13-3
<a href="#">FA-02</a>	Auxiliary speed command monitor	-590.00 - 590.00 (Hz) (for monitoring) 0.00 - 590.00 (Hz) (for setting)		13-3
<a href="#">FA-10</a>	Acceleration time monitor	0.00~3600.00 (s)		13-6
<a href="#">FA-12</a>	Deceleration time monitor	0.00~3600.00 (s)		13-6
<a href="#">FA-15</a>	Torque command monitor	-500.0~500.0 (%)		12-11-15
<a href="#">FA-16</a>	Torque bias command monitor	-500.0~500.0 (%)		12-11-12
<a href="#">FA-20</a>	Position command monitor	When [AA121]≠10 or [AA123]≠03 -268435455~+268435455 (pls)/ When [AA121]=10 and [AA123]=03 -1073741823~+1073741823 (pls)		12-17-30
<a href="#">FA-30</a>	PID1 target value 1	0.00~100.00 (%) (adjustable in [AH-04][AH-05][AH-06])		12-10-7
<a href="#">FA-32</a>	PID1 target value 2			
<a href="#">FA-34</a>	PID1 target value 3			
<a href="#">FA-36</a>	PID2 target value	0.00~100.00 (%) (adjustable in [AJ-04][AJ-05][AJ-06])		12-10-20
<a href="#">FA-38</a>	PID3 target value	0.00~100.00 (%) (adjustable in [AJ-24][AJ-25][AJ-26])		12-10-21
<a href="#">FA-40</a>	PID4 target value	0.00~100.00 (%) (adjustable in [AJ-44][AJ-45][AJ-46])		12-10-21

\*1) FA parameter indicates the current command value, and automatically displays data of the command destination that is being adopted.

Example 1: If the command destination is the operator keypad, it can be changed using the arrow keys.

Example 2: If the command destination is the analog input Ai1, it can be changed by changing input to the terminal [Ai1].

## A1.4 List of Parameter Modes

### ■ Parameter mode (code A)

Code	Name	Data range	Initial value	Note	Page
AA101	First main speed command selection	01 (Ai1 terminal input)/02 (Ai2 terminal input)/ 03 (Ai3 terminal input)/04 (Ai4 terminal input: P1-AG)/ 05 (Ai5 terminal input: P1-AG)/06 (Ai6 terminal input: P1-AG)/ 07 (Parameter setting)/08 (RS 485)/09 (Option 1)/ 10 (Option 2)/11 (Option 3)/12 (Pulse string input: main unit)/ 13 (Pulse string input: P1-FB)/14 (Program function)/ 15 (PID calculation)/16 (QOP-VR)	07 (*FF)/ 01 (*FEF, *FUF, *FCF)		
AA102	First auxiliary speed command selection	00 (Disabled)/01 (Ai1 terminal input)/02 (Ai2 terminal input)/ 03 (Ai3 terminal input)/04 (Ai4 terminal input: P1-AG)/ 05 (Ai5 terminal input: P1-AG)/06 (Ai6 terminal input: P1-AG)/ 07 (Parameter setting)/08 (RS 485)/09 (Option 1)/ 10 (Option 2)/11 (Option 3)/12 (Pulse string input: main unit)/ 13 (Pulse string input: P1-FB)/14 (Program function)/ 15 (PID calculation)/16 (QOP-VR)	00		
<a href="#">AA104</a>	First auxiliary speed setting	0.00~590.00 (Hz)	0.00		
AA105	First operator selection	00 (Disabled)/01 (Addition)/02 (Subtraction)/03 (Multiplication)	00		
<a href="#">AA106</a>	First additional frequency setting	-590.00~590.00 (Hz)	0.00		
AA111	First operation command selection	00 ([FW]/[RV] terminal)/01 (3 wire)/ 02 (RUN key on operator keypad)/03 (RS485)/04 (Option 1)/ 05 (Option 2)/06 (Option 3)	02 (*FF)/ 00 (*FEF, *FUF, *FCF)		
<a href="#">AA-12</a>	RUN key operation direction selection	00 (Normal rotation)/01 (Reverse rotation)	00		
AA-13	STOP key selection	00 (Disabled)/01 (Enabled)/02 (Only reset is enabled)	01		
AA114	First operation direction limit selection	00 (No limitation)/01 (Only normal rotation)/ 02 (Only reverse rotation)	00		
AA115	First stop mode selection	00 (Deceleration stop)/01 (Free run stop)	00		12-15-1
AA121	First control mode	00 ([V/f] Fixed torque characteristics (IM))/ 01 ([V/f] Reducing torque characteristics (IM))/ 02 ([V/f] Free V/f (IM))/03 ([V/f] Auto torque boost (IM))/ 04 ([V/f with sensor] Fixed torque characteristics (IM))/ 05 ([V/f with sensor] Reduced torque characteristics (IM))/ 06 ([V/f with sensor] Free V/f (IM))/ 07 ([V/f with sensor] Auto torque boost (IM))/ 08 (Sensorless vector control (IM))/ 09 (Zero-Hz range sensorless vector control (IM)) *1)/ 10 (Vector control with sensor (IM)) *1)/ 11 (Synchronous start type sensorless vector control (SM/PMM))/ 12 (IVMS start type sensorless vector control (SM/PMM)) *2)	00		12-9-1
AA123	First vector control mode selection	00 (Speed/torque control mode)/ 01 (Pulse string position control mode)/ 02 (Absolute position control mode)/ 03 (High-resolution absolute position control mode)	00		12-9-16

\*1) Cannot be selected if [Ub-03] duty spec selection is 01 (LD) or 02 (VLD).

\*2) Cannot be selected if [Ub-03] duty spec selection is 02 (VLD) or 02 (VLD).

Code	Name	Data range	Initial value	Note	Page
AA201	Second main speed command selection	01 (Ai1 terminal input)/02 (Ai2 terminal input)/ 03 (Ai3 terminal input)/04 (Ai4 terminal input: P1-AG)/ 05 (Ai5 terminal input: P1-AG)/06 (Ai6 terminal input: P1-AG)/ 07 (Parameter setting)/08 (RS 485)/09 (Option 1)/ 10 (Option 2)/11 (Option 3)/12 (Pulse string input: main unit)/ 13 (Pulse string input: P1-FB)/14 (Program function)/ 15 (PID calculation)/16 (QOP-VR)	07 (*FF)/ 01 (*FEF, *FUF, *FCF)		12-17-1
AA202	Second auxiliary speed command selection	00 (Disabled)/01 (Ai1 terminal input)/02 (Ai2 terminal input)/ 03 (Ai3 terminal input)/04 (Ai4 terminal input: P1-AG)/ 05 (Ai5 terminal input: P1-AG)/06 (Ai6 terminal input: P1-AG)/ 07 (Parameter setting)/08 (RS 485)/09 (Option 1)/ 10 (Option 2)/11 (Option 3)/12 (Pulse string input: main unit)/ 13 (Pulse string input: P1-FB)/14 (Program function)/ 15 (PID calculation)/16 (QOP-VR)	00		12-17-1
<a href="#">AA204</a>	Second auxiliary speed setting	0.00~590.00 (Hz)	0.00		12-17-1
AA205	Second operator selection	00 (Disabled)/01 (Addition)/02 (Subtraction)/03 (Multiplication)	00		12-17-1
<a href="#">AA206</a>	Second additional frequency setting	-590.00~590.00 (Hz)	0.00		12-17-1
AA211	Second operation command selection	00 ([FW]/[RV] terminal)/01 (3 wire)/ 02 (RUN key on operator keypad)/03 (RS485)/04 (Option 1)/ 05 (Option 2)/06 (Option 3)	02 (*FF)/ 00 (*FEF, *FUF, *FCF)		12-17-1
AA214	Second operation direction limit selection	00 (No limitation)/01 (Only normal rotation)/ 02 (Only reverse rotation)	00		12-17-1
AA215	Second stop mode selection	00 (Deceleration stop)/01 (Free run stop)	00		12-17-1
AA221	Second control mode	00 ([V/f] Fixed torque characteristics (IM))/ 01 ([V/f] Reducing torque characteristics (IM))/ 02 ([V/f] Free V/f (IM))/03 ([V/f] Auto torque boost (IM))/ 04 ([V/f with sensor] Fixed torque characteristics (IM))/ 05 ([V/f with sensor] Reduced torque characteristics (IM))/ 06 ([V/f with sensor] Free V/f (IM))/ 07 ([V/f with sensor] Auto torque boost (IM))/ 08 (Sensorless vector control (IM))/ 09 (Zero-Hz range sensorless vector control (IM)) *1)/ 10 (Vector control with sensor (IM))*1)/ 11 (Synchronous start type sensorless vector control (SM/PMM))/ 12 (IVMS start type sensorless vector control (SM/PMM)) *2)	00		12-17-1
AA223	First vector control mode selection	00 (Speed/torque control mode)/ 01 (Pulse string position control mode)/ 02 (Absolute position control mode)/ 03 (High-resolution absolute position control mode)	00		12-17-1

\*1) Cannot be selected if [Ub-03] duty spec selection is 01 (LD) or 02 (VLD).

\*2) Cannot be selected if [Ub-03] duty spec selection is 02 (VLD) or 02 (VLD).



Code	Name	Data range	Initial value	Note	Page
Ab-01	Frequency conversion coefficient	0.01~100.00	1.00		13-4
Ab-03	Multistep speed selection	00 (16th speed: binary (CF1~CF4))/ 01 (8th speed: bit (SF1-SF7))	00		
<a href="#">Ab110</a>	0th speed of the 1st multi-step speed	0.00~590.00 (Hz)	0.00		
<a href="#">Ab-11</a>	1st speed of the multi-step speed	0.00~590.00 (Hz)	0.00		
<a href="#">Ab-12</a>	2nd speed of the multi-step speed	0.00~590.00 (Hz)	0.00		
<a href="#">Ab-13</a>	3rd speed of the multi-step speed	0.00~590.00 (Hz)	0.00		
<a href="#">Ab-14</a>	4th speed of the multi-step speed	0.00~590.00 (Hz)	0.00		
<a href="#">Ab-15</a>	5th speed of the multi-step speed	0.00~590.00 (Hz)	0.00		
<a href="#">Ab-16</a>	6th speed of the multi-step speed	0.00~590.00 (Hz)	0.00		
<a href="#">Ab-17</a>	7th speed of the multi-step speed	0.00~590.00 (Hz)	0.00		
<a href="#">Ab-18</a>	8th speed of the multi-step speed	0.00~590.00 (Hz)	0.00		
<a href="#">Ab-19</a>	9th speed of the multi-step speed	0.00~590.00 (Hz)	0.00		
<a href="#">Ab-20</a>	10th speed of the multi-step speed	0.00~590.00 (Hz)	0.00		
<a href="#">Ab-21</a>	11th speed of the multi-step speed	0.00~590.00 (Hz)	0.00		
<a href="#">Ab-22</a>	12th speed of the multi-step speed	0.00~590.00 (Hz)	0.00		
<a href="#">Ab-23</a>	13th speed of the multi-step speed	0.00~590.00 (Hz)	0.00		
<a href="#">Ab-24</a>	14th speed of the multi-step speed	0.00~590.00 (Hz)	0.00		
<a href="#">Ab-25</a>	15th speed of the multi-step speed	0.00~590.00 (Hz)	0.00		
<a href="#">Ab210</a>	0th speed of the 2nd multi-step speed	0.00~590.00 (Hz)	0.00		12-17-1

Code	Name	Data range	Initial value	Note	Page
AC-01	Acceleration or deceleration time input type	00 (Parameter setting)/01 (Option 1)/ 02 (Option 2)/03 (Option 3)/ 04 (EzSQ function)	00		12-8-1
AC-02	Multi-stage acceleration or deceleration selection	00 (Common)/ 01 (Multi-stage acceleration/deceleration)	00		12-8-5
AC-03	Acceleration pattern selection	00 (Linear)/01 (S-shaped)/ 02 (U-shaped)/ 03 (Reverse U-shaped)/ 04 (Elevator S-shaped)	00		12-8-9
AC-04	Deceleration pattern selection	00 (Linear)/01 (S-shaped)/ 02 (U-shaped)/ 03 (Reverse U-shaped)/ 04 (Elevator S-shaped)	00		12-8-9
AC-05	Acceleration curve constant (S-shaped, U-shaped, reverse U-shaped)	1~10	2		12-8-10
AC-06	Deceleration curve constant (S-shaped, U-shaped, reverse U-shaped)	1~10	2		12-8-10
AC-08	Curvature 1 for EL-S-shaped acceleration	0~100	25		12-8-10
AC-09	Curvature 2 for EL-S-shaped acceleration	0~100	25		12-8-10
AC-10	Curvature 1 for EL-S-shaped deceleration	0~100	25		12-8-10
AC-11	Curvature 2 for EL-S-shaped deceleration	0~100	25		12-8-10
AC115	First 2-stage acceleration or deceleration selection	00 ([2CH] terminal)/ 01 (Parameter setting)/ 02 (Switching normal/reverse rotation)	00		12-8-3
<a href="#">AC116</a>	First 2-stage acceleration frequency	0.00~590.00 (Hz)	0.00		12-8-3
<a href="#">AC117</a>	First 2-stage deceleration frequency	0.00~590.00 (Hz)	0.00		12-8-3
<a href="#">AC120</a>	First acceleration time 1	0.00~3600.00 (s)	30.00		12-8-1
<a href="#">AC122</a>	First deceleration time 1	0.00~3600.00 (s)	30.00		12-8-1
<a href="#">AC124</a>	First acceleration time 2	0.00~3600.00 (s)	15.00		12-8-3
<a href="#">AC126</a>	First deceleration time 2	0.00~3600.00 (s)	15.00		12-8-3

Code	Name	Data range	Initial value	Note	Page
<a href="#">AC-30</a>	Acceleration time for multi-speed 1st speed	0.00~3600.00 (s)	0.00		12-8-5
<a href="#">AC-32</a>	Deceleration time for multi-speed 1st speed	0.00~3600.00 (s)	0.00		12-8-5
<a href="#">AC-34</a>	Acceleration time for multi-speed 2nd speed	0.00~3600.00 (s)	0.00		12-8-5
<a href="#">AC-36</a>	Deceleration time for multi-speed 2nd speed	0.00~3600.00 (s)	0.00		12-8-5
<a href="#">AC-38</a>	Acceleration time for multi-speed 3rd speed	0.00~3600.00 (s)	0.00		12-8-5
<a href="#">AC-40</a>	Deceleration time for multi-speed 3rd speed	0.00~3600.00 (s)	0.00		12-8-5
<a href="#">AC-42</a>	Acceleration time for multi-speed 4th speed	0.00~3600.00 (s)	0.00		12-8-5
<a href="#">AC-44</a>	Deceleration time for multi-speed 4th speed	0.00~3600.00 (s)	0.00		12-8-5
<a href="#">AC-46</a>	Acceleration time for multi-speed 5th speed	0.00~3600.00 (s)	0.00		12-8-5
<a href="#">AC-48</a>	Deceleration time for multi-speed 5th speed	0.00~3600.00 (s)	0.00		12-8-5
<a href="#">AC-50</a>	Acceleration time for multi-speed 6th speed	0.00~3600.00 (s)	0.00		12-8-5
<a href="#">AC-52</a>	Deceleration time for multi-speed 6th speed	0.00~3600.00 (s)	0.00		12-8-5
<a href="#">AC-54</a>	Acceleration time for multi-speed 7th speed	0.00~3600.00 (s)	0.00		12-8-5
<a href="#">AC-56</a>	Deceleration time for multi-speed 7th speed	0.00~3600.00 (s)	0.00		12-8-5
<a href="#">AC-58</a>	Acceleration time for multi-speed 8th speed	0.00~3600.00 (s)	0.00		12-8-5
<a href="#">AC-60</a>	Deceleration time for multi-speed 8th speed	0.00~3600.00 (s)	0.00		12-8-5
<a href="#">AC-62</a>	Acceleration time for multi-speed 9th speed	0.00~3600.00 (s)	0.00		12-8-5
<a href="#">AC-64</a>	Deceleration time for multi-speed 9th speed	0.00~3600.00 (s)	0.00		12-8-5
<a href="#">AC-66</a>	Acceleration time for multi-speed 10th speed	0.00~3600.00 (s)	0.00		12-8-5
<a href="#">AC-68</a>	Deceleration time for multi-speed 10th speed	0.00~3600.00 (s)	0.00		12-8-5
<a href="#">AC-70</a>	Acceleration time for multi-speed 11th speed	0.00~3600.00 (s)	0.00		12-8-5
<a href="#">AC-72</a>	Deceleration time for multi-speed 11th speed	0.00~3600.00 (s)	0.00		12-8-5
<a href="#">AC-74</a>	Acceleration time for multi-speed 12th speed	0.00~3600.00 (s)	0.00		12-8-5
<a href="#">AC-76</a>	Deceleration time for multi-speed 12th speed	0.00~3600.00 (s)	0.00		12-8-5
<a href="#">AC-78</a>	Acceleration time for multi-speed 13th speed	0.00~3600.00 (s)	0.00		12-8-5
<a href="#">AC-80</a>	Deceleration time for multi-speed 13th speed	0.00~3600.00 (s)	0.00		12-8-5
<a href="#">AC-82</a>	Acceleration time for multi-speed 14th speed	0.00~3600.00 (s)	0.00		12-8-5
<a href="#">AC-84</a>	Deceleration time for multi-speed 14th speed	0.00~3600.00 (s)	0.00		12-8-5
<a href="#">AC-86</a>	Acceleration time for multi-speed 15th speed	0.00~3600.00 (s)	0.00		12-8-5
<a href="#">AC-88</a>	Deceleration time for multi-speed 15th speed	0.00~3600.00 (s)	0.00		12-8-5
AC215	Second 2-stage acceleration or deceleration selection	00 ([2CH] terminal)/ 01 (Parameter setting)/ 02 (Switching normal/reverse rotation)	00		12-17-1
<a href="#">AC216</a>	Second 2-stage acceleration frequency	0.00~590.00 (Hz)	0.00		12-17-1
<a href="#">AC217</a>	Second 2-stage deceleration frequency	0.00~590.00 (Hz)	0.00		12-17-1
<a href="#">AC220</a>	Second acceleration time 1	0.00~3600.00 (s)	30.00		12-17-1
<a href="#">AC222</a>	Second deceleration time 1	0.00~3600.00 (s)	30.00		12-17-1
<a href="#">AC224</a>	Second acceleration time 2	0.00~3600.00 (s)	15.00		12-17-1
<a href="#">AC226</a>	Second deceleration time 2	0.00~3600.00 (s)	15.00		12-17-1

Code	Name	Data range	Initial value	Note	Page
Ad-01	Torque command input selection	00 (Disabled)/01 (Ai1 terminal input)/ 02 (Ai2 terminal input)/ 03 (Ai3 terminal input)/ 04 (Ai4 terminal input: P1-AG)/ 05 (Ai5 terminal input: P1-AG)/ 06 (Ai6 terminal input: P1-AG)/ 07 (Parameter setting)/08 (RS 485)/ 09 (Option 1)/10 (Option 2)/11 (Option 3)/ 12 (Pulse string input: main unit)/ 13 (Pulse string input: P1-FB)/ 15 (PID calculation)	07		12-11-15
<a href="#">Ad-02</a>	Torque command setting	-500.0~500.0 (%) (Limited at a torque equivalent to 200% of inverter ND rating)	0.0		12-11-15
Ad-03	Torque command polarity selection	00 (As per the sign)/ 01 (Follow the revolution direction)	00		12-11-15
<a href="#">Ad-04</a>	Speed/torque control switch time	0~1000 (ms)	100		12-11-14
Ad-11	Torque bias input selection	00 (Disabled)/01 (Ai1 terminal input)/ 02 (Ai2 terminal input)/ 03 (Ai3 terminal input)/ 04 (Ai4 terminal input: P1-AG)/ 05 (Ai5 terminal input: P1-AG)/ 06 (Ai6 terminal input: P1-AG)/ 07 (Parameter setting)/08 (RS 485)/ 09 (Option 1)/10 (Option 2)/11 (Option 3)/ 12 (Pulse string input: main unit)/ 13 (Pulse string input: P1-FB)/ 15 (PID calculation)	00		12-11-12
<a href="#">Ad-12</a>	Torque bias setting	-500.0~500.0 (%) (Limited at a torque equivalent to 200% of inverter ND rating)	0.0		12-11-12
Ad-13	Torque bias polarity selection	00 (As per the sign)/ 01 (Follow the revolution direction)	00		12-11-12
Ad-14	Torque bias enable terminal [TBS] selection	00 (Disabled)/01 (Enabled)	00		12-11-12
Ad-40	Torque control speed limit value input selection	01 (Ai1 terminal input)/ 02 (Ai2 terminal input)/ 03 (Ai3 terminal input)/ 04 (Ai4 terminal input: P1-AG)/ 05 (Ai5 terminal input: P1-AG)/ 06 (Ai6 terminal input: P1-AG)/ 07 (Parameter setting)/08 (RS 485)/ 09 (Option 1)/10 (Option 2)/11 (Option 3)/ 12 (Pulse string input: main unit)/ 13 (Pulse string input: P1-FB)	07		12-11-14
<a href="#">Ad-41</a>	Torque control frequency limit value (for normal rotation)	0.00~590.00 (Hz)	0.00		12-11-14
<a href="#">Ad-42</a>	Torque control frequency limit value (for reverse rotation)	0.00~590.00 (Hz)	0.00		12-11-14

Code	Name	Data range	Initial value	Note	Page
AE-01	Electronic gear installation position selection	00 (Feedback side)/01 (Command side)	00		12-17-17
AE-02	Electronic gear ratio numerator	1~10000	1		12-17-17
AE-03	Electronic gear ratio denominator	1~10000	1		12-17-17
AE-04	Positioning completion range setting	0~1000 (ms)	5		12-17-17
AE-05	Positioning completion delay time setting	0.00~10.00 (s)	0.00		12-17-17
AE-06	Position control feed forward	0.00~655.35	0.00		12-17-17
AE-07	Position loop gain	0.00~100.00	0.50		12-17-17
AE-08	Position bias amount	-2048~2048	0		12-17-17
AE-10	Orientation stop position input destination selection	00 (Parameter setting)/01 (Option 1)/02 (Option 2)/03 (Option 3)	00		12-17-23
<a href="#">AE-11</a>	Orientation stop position	0~4095	0		12-17-23
<a href="#">AE-12</a>	Orientation speed setting	0.00~120.00	0.00		12-17-23
AE-13	Orientation direction setting	00 (Normal rotation)/01 (Reverse rotation)	00		12-17-23
<a href="#">AE-20</a>	Position command 0	When [AA121]≠10 or [AA123]≠03 -268435455~+268435455 (pls)/ When [AA121]=10 and [AA123]=03 -1073741823~+1073741823 (pls)	0		12-17-30
<a href="#">AE-22</a>	Position command 1		0		12-17-30
<a href="#">AE-24</a>	Position command 2		0		12-17-30
<a href="#">AE-26</a>	Position command 3		0		12-17-30
<a href="#">AE-28</a>	Position command 4		0		12-17-30
<a href="#">AE-30</a>	Position command 5		0		12-17-30
<a href="#">AE-32</a>	Position command 6		0		12-17-30
<a href="#">AE-34</a>	Position command 7		0		12-17-30
<a href="#">AE-36</a>	Position command 8		0		12-17-30
<a href="#">AE-38</a>	Position command 9		0		12-17-30
<a href="#">AE-40</a>	Position command 10		0		12-17-30
<a href="#">AE-42</a>	Position command 11		0		12-17-30
<a href="#">AE-44</a>	Position command 12		0		12-17-30
<a href="#">AE-46</a>	Position command 13		0		12-17-30
<a href="#">AE-48</a>	Position command 14		0		12-17-30
<a href="#">AE-50</a>	Position command 15	0		12-17-30	

Code	Name	Data range	Initial value	Note	Page
<a href="#">AE-52</a>	Position range designation (forward rotation side)	When [AA121]≠10 or [AA123]≠03 0~+268435455 (pls)/ When [AA121]=10 and [AA123]=03 0~+1073741823 (pls)	268435455		12-17-30
<a href="#">AE-54</a>	Position range designation (reverse rotation side)	When [AA121]≠10 or [AA123]≠03 -268435455~0 (pls)/ When [AA121]=10 and [AA123]=03 -1073741823~0 (pls)	-268435455		12-17-30
<a href="#">AE-56</a>	Positioning mode selection	00 (With limit)/01 (Without limit)	00		12-17-31
<a href="#">AE-60</a>	Teaching selection	00 (X00)~15 (X15)	00		12-17-31
<a href="#">AE-61</a>	Memorization of current position at power-off	00 (Disabled)/01 (Enabled)	00		12-17-31
<a href="#">AE-62</a>	Preset position data	When [AA121]≠10 or [AA123]≠03 0~+268435455 (pls)/ When [AA121]=10 and [AA123]=03 0~+1073741823 (pls)	0		12-17-31
<a href="#">AE-64</a>	Gain for calculating the deceleration stop distance	50.00~200.00	100.00		12-17-24
<a href="#">AE-65</a>	Bias for calculating the deceleration stop distance	0.00~655.35	0.00		12-17-24
<a href="#">AE-66</a>	APR control speed limit	0.00~100.00	1.00		12-17-24
<a href="#">AE-67</a>	APR start speed	0.00~100.00	0.20		12-17-24
<a href="#">AE-70</a>	Zero return mode selection	00 (Low speed zero return)/ 01 (High speed zero return)/ 02 (High speed zero return 2)	00		12-17-32
<a href="#">AE-71</a>	Zero return direction selection	00 (Normal rotation)/01 (Reverse rotation)	00		12-17-32
<a href="#">AE-72</a>	Low speed zero return speed	0.00~10.00 (Hz)	0.00		12-17-32
<a href="#">AE-73</a>	High speed zero return speed	0.00~590.00 (Hz)	0.00		12-17-32

Code	Name	Data range	Initial value	Note	Page
<a href="#">AF101</a>	First DC braking selection	00 (Disabled)/01 (Enabled)/ 02 (Frequency command)	00		12-14-2 12-15-2
<a href="#">AF102</a>	First braking mode selection	00 (DC braking)/01 (Speed servo lock)/ 02 (Position servo lock)	00		12-14-2 12-15-2 12-14-14
<a href="#">AF103</a>	First DC braking frequency setting	0.00~590.00 (Hz)	0.50		12-14-2 12-15-2
<a href="#">AF104</a>	First DC braking delay time	0.00~5.00 (s)	0.00		12-14-2 12-15-2
<a href="#">AF105</a>	First DC braking force at the time of the stop	0-100 (%) (with internal limitation)	30		12-15-2
<a href="#">AF106</a>	First DC braking time at the time of the stop	0.00~60.00 (s)	0.00		12-15-2
<a href="#">AF107</a>	First DC braking trigger selection	00 (Edge mode)/01 (Level mode)	01		12-14-2 12-15-2
<a href="#">AF108</a>	First DC braking force at the start	0-100 (%) (with internal limitation)	30		12-14-2
<a href="#">AF109</a>	First DC braking time at the start	0.00~60.00 (s)	0.00		12-14-2

Code	Name	Data range	Initial value	Note	Page
AF120	First contactor control selection	00 (Disabled)/ 01 (Enabled: primary side)/ 02 (Enabled: secondary side)	00		12-17-10
<a href="#">AF121</a>	First start waiting time	0.00~2.00 (s)	0.20		12-17-10
<a href="#">AF122</a>	First contactor release delay time	0.00~2.00 (s)	0.10		12-17-10
<a href="#">AF123</a>	First contactor check time	0.00~5.00 (s)	0.10		12-17-10

Code	Name	Data range	Initial value	Note	Page
AF130	First brake control selection	00 (Disabled)/ 01 (Brake control 1 common in forward/reverse rotation)/ 02 (Brake control 1 forward/reverse set individually)/ 03 (Brake control 2)	00		12-17-5 12-17-9
<a href="#">AF131</a>	First brake release establishment waiting time (normal rotation)	0.00~5.00 (s)	0.00		12-17-5
<a href="#">AF132</a>	First acceleration waiting time (normal rotation)	0.00~5.00 (s)	0.00		12-17-5
<a href="#">AF133</a>	First stop waiting time (normal rotation)	0.00~5.00 (s)	0.00		12-17-5
<a href="#">AF134</a>	First brake confirmation waiting time (normal rotation)	0.00~5.00 (s)	0.00		12-17-5
<a href="#">AF135</a>	First brake release frequency (normal rotation)	0.00~590.00 (Hz)	0.00		12-17-5
<a href="#">AF136</a>	First brake release current (normal rotation)	(0.00 to 2.00) × Inverter rated current (A)	1.00 × Inverter rated current		12-17-5
<a href="#">AF137</a>	First brake apply frequency (normal rotation)	0.00~590.00 (Hz)	0.00		12-17-5
<a href="#">AF138</a>	First brake release establishment waiting time (reverse rotation)	0.00~5.00 (s)	0.00		12-17-5
<a href="#">AF139</a>	First acceleration waiting time (reverse rotation)	0.00~5.00 (s)	0.00		12-17-5
<a href="#">AF140</a>	First stop waiting time (reverse rotation)	0.00~5.00 (s)	0.00		12-17-5
<a href="#">AF141</a>	First brake confirmation waiting time (reverse rotation)	0.00~5.00 (s)	0.00		12-17-5
<a href="#">AF142</a>	First brake release frequency (reverse rotation)	0.00~590.00 (Hz)	0.00		12-17-5
<a href="#">AF143</a>	First brake release current (reverse rotation)	(0.00 to 2.00) × Inverter rated current (A)	1.00 × Inverter rated current		12-17-5
<a href="#">AF144</a>	First brake apply frequency (reverse rotation)	0.00~590.00 (Hz)	0.00		12-17-5
<a href="#">AF150</a>	First brake release delay time	0.00~2.00 (s)	0.20		12-17-9
<a href="#">AF151</a>	First brake apply delay time	0.00~2.00 (s)	0.20		12-17-9
<a href="#">AF152</a>	First brake check time	0.00~5.00 (s)	0.10		12-17-9
<a href="#">AF153</a>	First servo lock time at start	0.00~10.00 (s)	0.60		12-17-9
<a href="#">AF154</a>	First servo lock time at stop	0.00~10.00 (s)	0.60		12-17-9

Code	Name	Data range	Initial value	Note	Page
AF201	Second DC braking selection	00 (Disabled)/01 (Enabled)/ 02 (Frequency command)	00		12-17-1
AF202	Second braking mode selection	00 (DC braking)/ 01 (Speed servo lock)/ 02 (Position servo lock)	00		12-17-1
AF203	Second DC braking frequency setting	0.00~590.00 (Hz)	0.50		12-17-1
AF204	Second DC braking delay time	0.00~5.00 (s)	0.00		12-17-1
AF205	Second DC braking force at the time of the stop	0-100 (%) (with internal limitation)	30		12-17-1
AF206	Second DC braking time at the time of the stop	0.00~60.00 (s)	0.00		12-17-1
AF207	Second DC braking trigger selection	00 (Edge mode)/01 (Level mode)	01		12-17-1
AF208	Second DC braking force at the start	0-100 (%) (with internal limitation)	30		12-17-1
AF209	Second DC braking time at the start	0.00~60.00 (s)	0.00		12-17-1

Code	Name	Data range	Initial value	Note	Page
AF220	Second contactor control selection	00 (Disabled)/ 01 (Enabled: primary side)/ 02 (Enabled: secondary side)	00		12-17-1
AF221	Second start waiting time	0.00~2.00 (s)	0.20		12-17-1
AF222	Second contactor release delay time	0.00~2.00 (s)	0.10		12-17-1
AF223	Second contactor check time	0.00~5.00 (s)	0.10		12-17-1

Code	Name	Data range	Initial value	Note	Page
AF230	Second brake control selection	00 (Disabled)/ 01 (Brake control common in forward/reverse rotation)/ 02 (Brake control 1 forward/reverse set individually)	00		12-17-1
AF231	Second brake release establishment waiting time (normal rotation)	0.00~5.00 (s)	0.00		12-17-1
AF232	Second acceleration waiting time (normal rotation)	0.00~5.00 (s)	0.00		12-17-1
AF233	Second stop waiting time (normal rotation)	0.00~5.00 (s)	0.00		12-17-1
AF234	Second brake confirmation waiting time (normal rotation)	0.00~5.00 (s)	0.00		12-17-1
AF235	Second brake release frequency (normal rotation)	0.00~590.00 (Hz)	0.00		12-17-1
AF236	Second brake release current (normal rotation)	(0.00 to 2.00) × Inverter rated current (A)	1.00 × Inverter rated current		12-17-1
AF237	Second brake apply frequency (normal rotation)	0.00~590.00 (Hz)	0.00		12-17-1
AF238	Second brake release establishment waiting time (normal rotation)	0.00~5.00 (s)	0.00		12-17-1
AF239	Second acceleration waiting time (normal rotation)	0.00~5.00 (s)	0.00		12-17-1
AF240	Second stop waiting time (normal rotation)	0.00~5.00 (s)	0.00		12-17-1
AF241	Second brake confirmation waiting time (reverse rotation)	0.00~5.00 (s)	0.00		12-17-1
AF242	Second brake release frequency (reverse rotation)	0.00~590.00 (Hz)	0.00		12-17-1
AF243	Second brake release current (reverse rotation)	(0.00 to 2.00) × Inverter rated current (A)	1.00 × Inverter rated current		12-17-1
AF244	Second brake apply frequency (reverse rotation)	0.00~590.00 (Hz)	0.00		12-17-1

Code	Name	Data range	Initial value	Note	Page
AF250	Second brake release delay time	0.00~2.00 (s)	0.20		12-17-1
AF251	Second brake apply delay time	0.00~2.00 (s)	0.20		12-17-1
AF252	Second brake check time	0.00~5.00 (s)	0.10		12-17-1
AF253	Second servo lock time at start	0.00~10.00 (s)	0.60		12-17-1
AF254	Second servo lock time at stop	0.00~10.00 (s)	0.60		12-17-1

Code	Name	Data range	Initial value	Note	Page
AG101	First jump frequency 1	0.00~590.00 (Hz)	0.00		12-16-10
AG102	First jump frequency range 1	0.00~10.00 (Hz)	0.00		12-16-10
AG103	First jump frequency 2	0.00~590.00 (Hz)	0.00		12-16-10
AG104	First jump frequency range 2	0.00~10.00 (Hz)	0.00		12-16-10
AG105	First jump frequency 3	0.00~590.00 (Hz)	0.00		12-16-10
AG106	First jump frequency range 3	0.00~10.00 (Hz)	0.00		12-16-10
AG110	First acceleration-hold frequency	0.00~590.00 (Hz)	0.00		12-8-8
AG111	First acceleration-hold time	0.0~60.0 (s)	0.0		12-8-8
AG112	First deceleration-hold frequency	0.00~590.00 (Hz)	0.00		12-8-8
AG113	First deceleration-hold time	0.0~60.0 (s)	0.0		12-8-8
AG-20	Jogging frequency	0.00~10.00 (Hz)	6.00		
AG-21	Selecting the jogging stop	00 (Disabled during FRS operation at stop)/ 01 (Disabled during deceleration stop operation)/ 02 (Disabled during DB operation at stop)/ 03 (Enabled during FRS operation at stop)/ 04 (Enabled during deceleration stop operation)/ 05 (Enabled during DB operation at stop)	00		12-17-4
AG201	First jump frequency 2	0.00~590.00 (Hz)	0.00		12-17-1
AG202	First jump frequency range 2	0.00~10.00 (Hz)	0.00		12-17-1
AG203	Second jump frequency 2	0.00~590.00 (Hz)	0.00		12-17-1
AG204	Second jump frequency range 2	0.00~10.00 (Hz)	0.00		12-17-1
AG205	Second jump frequency 3	0.00~590.00 (Hz)	0.00		12-17-1
AG206	Second jump frequency range 3	0.00~10.00 (Hz)	0.00		12-17-1
AG210	Second acceleration-hold frequency	0.00~590.00 (Hz)	0.00		12-17-1
AG211	Second acceleration-hold time	0.0~60.0 (s)	0.0		12-17-1
AG212	Second deceleration-hold frequency	0.00~590.00 (Hz)	0.00		12-17-1
AG213	Second deceleration-hold time	0.0~60.0 (s)	0.0		12-17-1



Code	Name	Data range	Initial value	Note	Page
AH-01	PID1 selection	00 (Disabled)/ 01 (Enabled Without reverse output)/ 02 (Enabled With reverse output)	00		12-10-5
AH-02	PID1 deviation negative	00 (Disabled)/01 (Enabled)	00		12-10-5
AH-03	PID1 unit selection	See <Unit options> at the end of Appendix-1	01		12-10-31
<a href="#">AH-04</a>	PID1 scale adjustment (0%)	-10000~10000	0		12-10-31
<a href="#">AH-05</a>	PID1 scale adjustment (100%)	-10000~10000	10000		12-10-31
<a href="#">AH-06</a>	PID1 scale adjustment (decimal point)	0~4	2		12-10-31
AH-07	PID1 target value 1 input destination selection	00 (None)/01 (Ai1 terminal input)/ 02 (Ai2 terminal input)/ 03 (Ai3 terminal input)/ 04 (Ai4 terminal input: P1-AG)/ 05 (Ai5 terminal input: P1-AG)/ 06 (Ai6 terminal input: P1-AG)/ 07 (Parameter setting)/08 (RS 485)/ 09 (Option 1)/10 (Option 2)/11 (Option 3)/ 12 (Pulse string input: main unit)/ 13 (Pulse string input: P1-FB)	07		12-10-10
<a href="#">AH-10</a>	PID1 target value 1 set value	-100.00~100.00 *1)	0.00		12-10-10
<a href="#">AH-12</a>	PID1 multistage target value 1	-100.00~100.00 *1)	0.00		12-10-10
<a href="#">AH-14</a>	PID1 multistage target value 2	-100.00~100.00 *1)	0.00		12-10-10
<a href="#">AH-16</a>	PID1 multistage target value 3	-100.00~100.00 *1)	0.00		12-10-10
<a href="#">AH-18</a>	PID1 multistage target value 4	-100.00~100.00 *1)	0.00		12-10-10
<a href="#">AH-20</a>	PID1 multistage target value 5	-100.00~100.00 *1)	0.00		12-10-10
<a href="#">AH-22</a>	PID1 multistage target value 6	-100.00~100.00 *1)	0.00		12-10-10
<a href="#">AH-24</a>	PID1 multistage target value 7	-100.00~100.00 *1)	0.00		12-10-10
<a href="#">AH-26</a>	PID1 multistage target value 8	-100.00~100.00 *1)	0.00		12-10-10
<a href="#">AH-28</a>	PID1 multistage target value 9	-100.00~100.00 *1)	0.00		12-10-10
<a href="#">AH-30</a>	PID1 multistage target value 10	-100.00~100.00 *1)	0.00		12-10-10
<a href="#">AH-32</a>	PID1 multistage target value 11	-100.00~100.00 *1)	0.00		12-10-10
<a href="#">AH-34</a>	PID1 multistage target value 12	-100.00~100.00 *1)	0.00		12-10-10
<a href="#">AH-36</a>	PID1 multistage target value 13	-100.00~100.00 *1)	0.00		12-10-10
<a href="#">AH-38</a>	PID1 multistage target value 14	-100.00~100.00 *1)	0.00		12-10-10
<a href="#">AH-40</a>	PID1 multistage target value 15	-100.00~100.00 *1)	0.00		12-10-10

\*1) Data range differs depending on [AH-04] - [AH-06].

Code	Name	Data range	Initial value	Note	Page
AH-42	PID1 target value 2 input destination selection	00 (None)/01 (Ai1 terminal input)/ 02 (Ai2 terminal input)/03 (Ai3 terminal input)/ 04 (Ai4 terminal input: P1-AG)/ 05 (Ai5 terminal input: P1-AG)/ 06 (Ai6 terminal input: P1-AG)/ 07 (Parameter setting)/08 (RS 485)/ 09 (Option 1)/10 (Option 2)/11 (Option 3)/ 12 (Pulse string input: main unit)/ 13 (Pulse string input: P1-FB)	00		12-10-10
<a href="#">AH-44</a>	PID1 target value 2 set value	-100.00~100.00 (%) *1)	0.00		12-10-10
AH-46	PID1 target value 3 input destination selection	00 (None)/01 (Ai1 terminal input)/ 02 (Ai2 terminal input)/03 (Ai3 terminal input)/ 04 (Ai4 terminal input: P1-AG)/ 05 (Ai5 terminal input: P1-AG)/ 06 (Ai6 terminal input: P1-AG)/ 07 (Parameter setting)/08 (RS 485)/ 09 (Option 1)/10 (Option 2)/11 (Option 3)/ 12 (Pulse string input: main unit)/ 13 (Pulse string input: P1-FB)	00		12-10-10
<a href="#">AH-48</a>	PID1 target value 3 set value	-100.00~100.00 (%) *1)	0.00		12-10-10
AH-50	PID1 target value 1 operator selection	01 (Addition)/02 (Subtraction)/ 03 (Multiplication)/04 (Division)	01		12-10-10
AH-51	PID1 feedback Data 1 Input destination selection	00 (None)/01 (Ai1 terminal input)/ 02 (Ai2 terminal input)/03 (Ai3 terminal input)/ 04 (Ai4 terminal input: P1-AG)/ 05 (Ai5 terminal input: P1-AG)/	01		12-10-6
AH-52	PID1 feedback Data 2 Input destination selection	06 (Ai6 terminal input: P1-AG)/ 07 (Parameter setting)/08 (RS 485)/ 09 (Option 1)/10 (Option 2)/11 (Option 3)/	00		12-10-6
AH-53	PID1 feedback Data 3 Input destination selection	12 (Pulse string input: main unit)/ 13 (Pulse string input: P1-FB)	00		12-10-6
AH-54	PID1 feedback Data operator selection	01 (Addition)/02 (Subtraction)/ 03 (Multiplication)/04 (Division)	01		12-10-6
AH-60	PID1 gain switch method selection	00 (Only gain 1)/01 ([PRO] terminal switch)	00		12-10-6
<a href="#">AH-61</a>	PID1 proportional gain 1	0.0~100.0	1.0		12-10-6
<a href="#">AH-62</a>	PID1 integral gain 1	0.0~3600.0 (s)	1.0		12-10-6
<a href="#">AH-63</a>	PID1 differential gain 1	0.00~100.00 (s)	0.00		12-10-6
<a href="#">AH-64</a>	PID1 proportional gain 2	0.0~100.0	0.0		12-10-6
<a href="#">AH-65</a>	PID1 integral gain 2	0.00~3600.0 (s)	0.0		12-10-6
<a href="#">AH-66</a>	PID1 differential gain 2	0.00~100.00 (s)	0.00		12-10-6
<a href="#">AH-67</a>	PID1 gain switch time	0~10000 (ms)	100		12-10-6

\*1) Data range differs depending on [AH-04] - [AH-06].

Code	Name	Data range	Initial value	Note	Page
AH-70	PID feed-forward selection	00 (Disabled)/ 01 (Ai1 terminal input)/ 02 (Ai2 terminal input)/ 03 (Ai3 terminal input)/ 04 (Ai4 terminal input: P1-AG)/ 05 (Ai5 terminal input: P1-AG)/ 06 (Ai6 terminal input: P1-AG)	00		12-10-6
<a href="#">AH-71</a>	PID1 changeable range	0.00~100.00 (%)	0.00		12-10-13
<a href="#">AH-72</a>	PID1 deviation excessive level	0.00~100.00 (%)	3.00		12-10-28
<a href="#">AH-73</a>	PID1 feedback comparison signal OFF level	0.00~100.00 (%)	100.00		12-10-29
<a href="#">AH-74</a>	PID1 feedback comparison signal ON level	0.00~100.00 (%)	0.00		12-10-29
AH-75	PID soft-start function selection	00 (Disabled)/01 (Enabled)	00		12-10-15
<a href="#">AH-76</a>	PID soft-start target level	0.00~100.00 (%)	100.00		12-10-15
<a href="#">AH-78</a>	Acceleration time for PID soft-start	0.00~3600.00 (s)	30.00		12-10-15
<a href="#">AH-80</a>	PID soft-start time	0.00~100.00 (s)	0.00		12-10-15
AH-81	PID start abnormal judgment implement selection	00 (Disabled)/ 01 (Enabled: error output)/ 02 (Enabled: warning)	00		12-10-16
<a href="#">AH-82</a>	PID start abnormality judgment level	0.00~100.00 (%)	0.00		12-10-16
AH-85	PID sleep condition selection	00 (Disabled)/01 (Low output)/ 02 ([SLEP] terminal)	00		12-10-17
<a href="#">AH-86</a>	PID sleep start level	0.00~590.00 (Hz)	0.00		12-10-17
<a href="#">AH-87</a>	PID sleep operation time	0.00~100.00 (s)	0.00		12-10-17
AH-88	Boost selection prior to PID sleep	00 (Disabled)/01 (Enabled)	00		12-10-17
<a href="#">AH-89</a>	Boost time prior to PID sleep	0.00~100.00 (s)	0.00		12-10-17
<a href="#">AH-90</a>	Boost amount prior to PID sleep	0.00~100.00 (%)	0.00		12-10-17
<a href="#">AH-91</a>	Minimum operation time prior to PID sleep	0.00~100.00 (s)	0.00		12-10-17
<a href="#">AH-92</a>	PID sleep status minimum retaining time	0.00~100.00 (s)	0.00		12-10-17
AH-93	PID wake condition selection	01 (Deviation amount)/ 02 (Low feedback)/ 03 ([WAKE] terminal)	01		12-10-17
<a href="#">AH-94</a>	PID wake start level	0.00~100.00 (%)	0.00		12-10-17
<a href="#">AH-95</a>	PID wake operation time	0.00~100.00 (s)	0.00		12-10-17
<a href="#">AH-96</a>	PID wake start deviation amount	0.00~100.00 (%)	0.00		12-10-17

Code	Name	Data range	Initial value	Note	Page
AJ-01	PID2 selection	00 (Disabled)/ 01 (Enabled Without reverse output)/ 02 (Enabled With reverse output)	00		12-10-23 12-10-27
AJ-02	PID2 deviation negative	00 (Disabled)/01 (Enabled)	00		12-10-23
AJ-03	PID2 unit selection	See <Unit options> at the end of Appendix-1	01		12-10-31
<u>AJ-04</u>	PID2 scale adjustment (0%)	-10000~10000	0		12-10-31
<u>AJ-05</u>	PID2 scale adjustment (100%)	-10000~10000	10000		12-10-31
<u>AJ-06</u>	PID2 scale adjustment (decimal point)	0~4	2		12-10-31
AJ-07	PID2 target value input destination selection	00 (None)/01 (Ai1 terminal input)/ 02 (Ai2 terminal input)/ 03 (Ai3 terminal input)/ 04 (Ai4 terminal input: P1-AG)/ 05 (Ai5 terminal input: P1-AG)/ 06 (Ai6 terminal input: P1-AG)/ 07 (Parameter setting)/08 (RS 485)/ 09 (Option 1)/10 (Option 2)/11 (Option 3)/ 12 (Pulse string input: main unit)/ 13 (Pulse string input: P1-FB)/ 15 (PID1 output)	07		12-10-23
<u>AJ-10</u>	PID2 target value set value	-100.00~100.00 (%) *1)	0.00		12-10-23
AJ-12	PID2 feedback data input destination selection	00 (None)/01 (Ai1 terminal input)/ 02 (Ai2 terminal input)/ 03 (Ai3 terminal input)/ 04 (Ai4 terminal input: P1-AG)/ 05 (Ai5 terminal input: P1-AG)/ 06 (Ai6 terminal input: P1-AG)/ 07 (Parameter setting)/08 (RS 485)/ 09 (Option 1)/10 (Option 2)/11 (Option 3)/ 12 (Pulse string input: main unit)/ 13 (Pulse string input: P1-FB)	02		12-10-23
<u>AJ-13</u>	PID2 proportional gain	0.0~100.0	1.0		12-10-23
<u>AJ-14</u>	PID2 integral gain	0.0~3600.0 (s)	1.0		12-10-23
<u>AJ-15</u>	PID2 differential gain	0.00~100.00 (s)	0.00		12-10-23
<u>AJ-16</u>	PID2 changeable range	0.00~100.00 (%)	0.00		12-10-27
<u>AJ-17</u>	PID2 deviation excessive level	0.00~100.00 (%)	3.00		12-10-28
<u>AJ-18</u>	PID2 feedback comparison signal OFF level	0.00~100.00 (%)	100.00		12-10-29
<u>AJ-19</u>	PID2 feedback comparison signal ON level	0.00~100.00 (%)	0.00		12-10-29

\*1) Data range differs depending on [AJ-04] - [AJ-06].

Code	Name	Data range	Initial value	Note	Page
AJ-21	PID3 selection	00 (Disabled)/ 01 (Enabled Without reverse output)/ 02 (Enabled With reverse output)	00		12-10-23 12-10-27
AJ-22	PID3 deviation negative	00 (Disabled)/01 (Enabled)	00		12-10-23
AJ-23	PID3 unit selection	See <Unit options> at the end of Appendix-1	01		12-10-31
<a href="#">AJ-24</a>	PID3 scale adjustment (0%)	-10000~10000	0		12-10-31
<a href="#">AJ-25</a>	PID3 scale adjustment (100%)	-10000~10000	10000		12-10-31
<a href="#">AJ-26</a>	PID3 scale adjustment (decimal point)	0~4	2		12-10-31
AJ-27	PID3 target value input destination selection	00 (None)/01 (Ai1 terminal input)/ 02 (Ai2 terminal input)/ 03 (Ai3 terminal input)/ 04 (Ai4 terminal input: P1-AG)/ 05 (Ai5 terminal input: P1-AG)/ 06 (Ai6 terminal input: P1-AG)/ 07 (Parameter setting)/08 (RS 485)/ 09 (Option 1)/10 (Option 2)/11 (Option 3)/ 12 (Pulse string input: main unit)/ 13 (Pulse string input: P1-FB)	07		12-10-23
<a href="#">AJ-30</a>	PID3 target value set value	-100.00~100.00 (%) *1)	0.00		12-10-23
AJ-32	PID3 feedback data input destination selection	00 (None)/01 (Ai1 terminal input)/ 02 (Ai2 terminal input)/ 03 (Ai3 terminal input)/ 04 (Ai4 terminal input: P1-AG)/ 05 (Ai5 terminal input: P1-AG)/ 06 (Ai6 terminal input: P1-AG)/ 07 (Parameter setting)/08 (RS 485)/ 09 (Option 1)/10 (Option 2)/11 (Option 3)/ 12 (Pulse string input: main unit)/ 13 (Pulse string input: P1-FB)	02		12-10-23
<a href="#">AJ-33</a>	PID3 proportional gain	0.0~100.0	1.0		12-10-23
<a href="#">AJ-34</a>	PID3 integral gain	0.00~3600.0 (s)	1.0		12-10-23
<a href="#">AJ-35</a>	PID3 differential gain	0.0~100.00 (s)	0.00		12-10-23
<a href="#">AJ-36</a>	PID3 changeable range	0.00~100.00 (%)	0.00		12-10-27
<a href="#">AJ-37</a>	PID3 deviation excessive level	0.00~100.00 (%)	3.00		12-10-28
<a href="#">AJ-38</a>	PID3 feedback comparison signal OFF level	0.00~100.00 (%)	100.00		12-10-29
<a href="#">AJ-39</a>	PID3 feedback comparison signal ON level	0.00~100.00 (%)	0.00		12-10-29

\*1) Data range differs depending on [AJ-24] - [AJ-26].

Code	Name	Data range	Initial value	Note	Page
AJ-41	PID4 selection	00 (Disabled)/ 01 (Enabled Without reverse output)/ 02 (Enabled With reverse output)	00		12-10-24 12-10-27
AJ-42	PID4 deviation negative	00 (Disabled)/01 (Enabled)	00		12-10-24
AJ-43	PID4 unit selection	See <Unit options> at the end of Appendix-1	01		12-10-31
<a href="#">AJ-44</a>	PID4 scale adjustment (0%)	-10000~10000	0		12-10-31
<a href="#">AJ-45</a>	PID4 scale adjustment (100%)	-10000~10000	10000		12-10-31
<a href="#">AJ-46</a>	PID4 scale adjustment (decimal point)	0~4	2		12-10-31
AJ-47	PID4 target value input destination 1 selection	00 (None)/01 (Ai1 terminal input)/ 02 (Ai2 terminal input)/ 03 (Ai3 terminal input)/ 04 (Ai4 terminal input: P1-AG)/ 05 (Ai5 terminal input: P1-AG)/ 06 (Ai6 terminal input: P1-AG)/ 07 (Parameter setting)/08 (RS 485)/ 09 (Option 1)/10 (Option 2)/11 (Option 3)/ 12 (Pulse string input: main unit)/ 13 (Pulse string input: P1-FB)	07		12-10-24
<a href="#">AJ-50</a>	PID4 target value set value 2	-100.00~100.00 (%) *1)	0.00		12-10-24
AJ-52	PID4 feedback data input destination selection	00 (None)/01 (Ai1 terminal input)/ 02 (Ai2 terminal input)/ 03 (Ai3 terminal input)/ 04 (Ai4 terminal input: P1-AG)/ 05 (Ai5 terminal input: P1-AG)/ 06 (Ai6 terminal input: P1-AG)/ 07 (Parameter setting)/08 (RS 485)/ 09 (Option 1)/10 (Option 2)/11 (Option 3)/ 12 (Pulse string input: main unit)/ 13 (Pulse string input: P1-FB)	02		12-10-24
<a href="#">AJ-53</a>	PID4 proportional gain	0.0~100.0	1.0		12-10-24
<a href="#">AJ-54</a>	PID4 integral gain	0.00~3600.0 (s)	1.0		12-10-24
<a href="#">AJ-55</a>	PID4 differential gain	0.0~100.00 (s)	0.00		12-10-24
<a href="#">AJ-56</a>	PID4 changeable range	0.00~100.00 (%)	0.00		12-10-27
<a href="#">AJ-57</a>	PID4 deviation excessive level	0.00~100.00 (%)	3.00		12-10-28
<a href="#">AJ-58</a>	PID4 feedback comparison signal OFF level	0.00~100.00 (%)	100.00		12-10-29
<a href="#">AJ-59</a>	PID4 feedback comparison signal ON level	0.00~100.00 (%)	0.00		12-10-29

\*1) Data range differs depending on [AJ-44] - [AJ-46].

## ■ Parameter mode (code B)

Code	Name	Data range	Initial value	Note	Page
bA101	First frequency upper limit selection	00 (Disabling)/01 (Ai1 terminal input)/ 02 (Ai2 terminal input)/ 03 (Ai3 terminal input)/ 04 (Ai4 terminal input)/ 05 (Ai5 terminal input)/ 06 (Ai6 terminal input)/ 07 (Parameter setting)/ 08 (RS485)/09 (Option 1)/ 10 (Option 2)/11 (Option 3)/ 12 (Pulse string input (main body))/ 13 (Pulse string input P1-FB)	00		
<a href="#">bA102</a>	First frequency upper limiter	0.00~590.00 (Hz)	0.00		
<a href="#">bA103</a>	First frequency lower limiter	0.00~590.00 (Hz)	0.00		
bA110	First torque limit selection	00 (Disable)/01 (Ai1 terminal input)/ 02 (Ai2 terminal input)/ 03 (Ai3 terminal input)/ 04 (Ai4 terminal input)/ 05 (Ai5 terminal input)/ 06 (Ai6 terminal input)/ 07 (Parameter setting)/ 08 (RS 485)/09 (Option 1)/ 10 (Option 2)/11 (Option 3)	07		12-11-8
bA111	First torque limit parameter mode selection	00 (Four quadrant specific)/ 01 ([TRQ] terminal switch)	00		12-11-8
<a href="#">bA112</a>	First torque limit 1 (Four quadrant normal powered)	0.0~500.0 (%) (Limited at a torque equivalent to 200% of inverter ND rating)	150.0		12-11-8
<a href="#">bA113</a>	First torque limit 2 (Four quadrant reverse rotation regeneration)	0.0~500.0 (%) (Limited at a torque equivalent to 200% of inverter ND rating)	150.0		12-11-8
<a href="#">bA114</a>	First torque limit 3 (Four quadrant reverse powered)	0.0~500.0 (%) (Limited at a torque equivalent to 200% of inverter ND rating)	150.0		12-11-8
<a href="#">bA115</a>	First torque limit 4 (Four quadrant normal rotation regeneration)	0.0~500.0 (%) (Limited at a torque equivalent to 200% of inverter ND rating)	150.0		12-11-8
bA116	First torque LAD stop selection	00 (Disabled)/01 (Enabled)	00		12-11-8
bA120	First overcurrent suppression selection	00 (Disabled)/01 (Enabled)	01		12-13-3
bA121	First overcurrent suppression level	(0.00 to 2.00) × Inverter rated current (A)	*1)		12-13-3
bA122	First overload limit 1 selection	00 (Disabled)/ 01 (Accelerate at constant speed)/ 02 (Only constant speed)/ 03 (Accelerate at constant speed/Increase speed at regeneration)	01		12-13-2
<a href="#">bA123</a>	First overload limit level 1	(0.20 to 2.00) × Inverter rated current (A)	*2)		12-13-2
<a href="#">bA124</a>	First overload limit 1 operation time	0.10~3600.00 (s)	1.00		12-13-2
bA126	First overload limit 2 selection	00 (Disabled)/ 01 (Accelerate at constant speed)/ 02 (Only constant speed)/ 03 (Accelerate at constant speed/Increase speed at regeneration)	01		12-13-2
<a href="#">bA127</a>	First overload limit level 2	(0.20 to 2.00) × Inverter rated current (A)	*2)		12-13-2
<a href="#">bA128</a>	First overload limit 2 operation time	0.10~3600.00 (s)	1.00		12-13-2

\*1) 1.80 × Inverter rated current (A)

\*2) 1.50 × Inverter rated current (A)

Code	Name	Data range	Initial value	Note	Page
bA-30	Instantaneous power failure non-stop selection	00 (Disabled)/ 01 (Enabled: deceleration stop)/ 02 (Enabled: no recovery)/ 03 (Enabled: with recovery)	00		12-13-17
<a href="#">bA-31</a>	Instantaneous power failure non-stop function starting voltage	(200V class) 0.0 - 410.0 (V) (400V class) 0.0 - 820.0 (V)	(200 V class) 220.0 (400V class) 440.0		12-13-17
<a href="#">bA-32</a>	Instantaneous power failure non-stop target level	(200V class) 0.0 - 410.0 (V) (400V class) 0.0 - 820.0 (V)	(200 V class) 360.0 (400V class) 720.0		12-13-17
<a href="#">bA-34</a>	Instantaneous power failure non-stop deceleration time	0.01~3600.00 (s)	1.00		12-13-17
<a href="#">bA-36</a>	Instantaneous power failure non-stop deceleration starting range	0.00~10.00 (Hz)	0.00		12-13-17
<a href="#">bA-37</a>	Instantaneous power failure non-stop constant DC voltage control P gain	0.00~5.00	0.20		12-13-17
<a href="#">bA-38</a>	Instantaneous power failure non-stop constant DC voltage control I gain	0.00~150.00 (s)	1.00		12-13-17
<a href="#">bA140</a>	First overvoltage suppression function	00 (Disabled)/ 01 (DC voltage constant deceleration) 02 (Acceleration only at deceleration)/ 03 (Acceleration at constant speed/deceleration)	00		12-13-4
<a href="#">bA141</a>	First overvoltage suppression level setting	(200V class) 330.0 - 400.0 (V) (400V class) 660.0 - 800.0 (V)	(200 V class) 380.0 (400V class) 760.0		12-13-4
<a href="#">bA142</a>	First overvoltage suppression operating time	0.00~3600.00 (s)	1.00		12-13-4
<a href="#">bA144</a>	First DC voltage control P gain	0.00~5.00	0.20		12-13-4
<a href="#">bA145</a>	First DC voltage control I gain	0.00~150.00 (s)	1.00		12-13-4
<a href="#">bA146</a>	First overexcitation function selection	00 (Disabled)/ 01 (Regular operation)/ 02 (Operation only at deceleration)/ 03 (Level mode)/ 04 (Level mode only at deceleration)	02		12-13-6
<a href="#">bA147</a>	First overexcitation filter time constant	0.00~1.00(s)	0.30		12-13-6
<a href="#">bA148</a>	First overexcitation voltage gain	50~400 (%)	100		12-13-6
<a href="#">bA149</a>	First overexcitation control level setting	(200V class) 330.0 - 400.0 (V) (400V class) 660.0 - 800.0 (V)	(200 V class) 360.0 (400V class) 720.0		12-13-6
<a href="#">bA-60</a>	Braking resistor operation circuit (BRD) use rate	0.0 - 10.0×([bA-63]/minimum resistance) <sup>2</sup> (%) *1)	10.0		12-13-8
bA-61	Braking resistor circuit (BRD) selection	00 (Disabled)/ 01 (Enabled: disabled at stop)/ 02 (Enabled: enabled at stop)	00		12-13-8
bA-62	Braking resistor circuit (BRD) ON level	(200V class) 330.0 - 400.0 (V) (400V class) 660.0 - 800.0 (V)	(200 V class) 360.0 (400V class) 720.0		12-13-8
bA-63	Braking resistor circuit (BRD) resistance	Minimum resistance - 600 (Ω)	Minimum resistance *1)		12-13-8
<a href="#">bA-70</a>	Selection of the cooling fan operation	00 (Always ON)/ 01 (ON during operation)/ 02 (Temperature dependent)	00		12-18-1
bA-71	Clear cumulative operating time of cooling fan	00 (Disabled)/01 (Clear)	00		13-17

\*1) The minimum resistance varies depending on inverter models.



Code	Name	Data range	Initial value	Note	Page
bA201	Upper limit of second frequency	00 (Disabling)/01 (Ai1 terminal input)/ 02 (Ai2 terminal input)/03 (Ai3 terminal input)/ 04 (Ai4 terminal input)/05 (Ai5 terminal input)/ 06 (Ai6 terminal input)/07 (Parameter setting)/ 08 (RS485)/09 (Option 1)/10 (Option 2)/ 11 (Option 3)/12 (Pulse string input (main body))/ 13 (Pulse string input P1-FB)	00		12-17-1
<a href="#">bA202</a>	Second frequency upper limiter	0.00~590.00 (Hz)	0.00		12-17-1
<a href="#">bA203</a>	Second frequency lower limiter	0.00~590.00 (Hz)	0.00		12-17-1
bA210	Second torque limit selection	00 (Disable)/01 (Ai1 terminal input)/ 02 (Ai2 terminal input)/03 (Ai3 terminal input)/ 04 (Ai4 terminal input)/05 (Ai5 terminal input)/ 06 (Ai6 terminal input)/07 (Parameter setting)/ 08 (RS 485)/09 (Option 1)/10 (Option 2)/ 11 (Option 3)	07		12-17-1
bA211	Second torque limit parameter mode selection	00 (Four quadrant specific)/ 01 ([TRQ] terminal switch)	00		12-17-1
<a href="#">bA212</a>	First torque limit 2 (Four quadrant normal powering)	0.0 - 500.0 (%) (Limited at at torque equivalent to 200% of inverter ND rating)	150.0 (%)		12-17-1
<a href="#">bA213</a>	Second torque limit 2 (Four quadrant reverse rotation regeneration)	0.0 - 500.0 (%) (Limited at at torque equivalent to 200% of inverter ND rating)	150.0 (%)		12-17-1
<a href="#">bA214</a>	Second torque limit 3 (Four quadrant reverse powering)	0.0 - 500.0 (%) (Limited at at torque equivalent to 200% of inverter ND rating)	150.0 (%)		12-17-1
<a href="#">bA215</a>	Second torque limit 4 (Four quadrant normal rotation regeneration)	0.0 - 500.0 (%) (Limited at at torque equivalent to 200% of inverter ND rating)	150.0 (%)		12-17-1
bA216	Second torque LAD stop selection	00 (Disabled)/01 (Enabled)	00		12-17-1

Code	Name	Data range	Initial value	Note	Page
bA220	Second overcurrent suppression selection	00 (Disabled)/01 (Enabled)	01		12-17-1
bA221	Second overcurrent suppression level	(0.00 to 2.00) × Inverter rated current (A)	*1)		12-17-1
bA222	First overload limit 2 selection	00 (Disabled)/ 01 (Accelerate at constant speed)/ 02 (Only constant speed)/ 03 (Accelerate at constant speed/Increase speed at regeneration)	01		12-17-1
<a href="#">bA223</a>	First overload limit level 2	(0.20 to 2.00) × Inverter rated current (A)	*2)		12-17-1
<a href="#">bA224</a>	First overload limit 2 operation time	0.10~3600.00 (s)	1.00		12-17-1
bA226	Second overload limit 2 selection	00 (Disabled)/ 01 (Accelerate at constant speed)/ 02 (Only constant speed)/ 03 (Accelerate at constant speed/Increase speed at regeneration)	00		12-17-1
<a href="#">bA227</a>	Second overload limit level 2	(0.20 to 2.00) × Inverter rated current (A)	*2)		12-17-1
<a href="#">bA228</a>	Second overload limit 2 operation time	0.10~3600.00 (s)	1.00		12-17-1
<a href="#">bA240</a>	Second overvoltage suppression function	00 (Disabled)/ 01 (DC voltage constant deceleration)/ 02 (Acceleration only at deceleration)/ 03 (Acceleration at constant speed/deceleration)	00		12-17-1
<a href="#">bA241</a>	Second overvoltage suppression level setting	(200V class) 330.0 - 400.0 (V) (400V class) 660.0 - 800.0 (V)	(200 V class) 380.0 (400V class) 760.0		12-17-1
<a href="#">bA242</a>	Second overvoltage suppression operating time	0.00~3600.00 (s)	1.00		12-17-1
<a href="#">bA244</a>	Second DC voltage control P gain	0.00~5.00	0.20		12-17-1
<a href="#">bA245</a>	Second DC voltage control I gain	0.00~150.00 (s)	1.00		12-17-1
<a href="#">bA246</a>	Second overexcitation function selection	00 (Disabled)/01 (Regular operation)/ 02 (Operation only at deceleration)/ 03 (Level mode)/ 04 (Level mode only at deceleration)	02		12-17-1
<a href="#">bA247</a>	Second overexcitation filter time constant	0.00~1.00 (s)	0.30		12-17-1
<a href="#">bA248</a>	Second overexcitation voltage gain	50~400 (%)	100		12-17-1
<a href="#">bA249</a>	Second overexcitation control level setting	(200V class) 330.0 - 400.0 (V) (400V class) 660.0 - 800.0 (V)	(200 V class) 360.0 (400V class) 720.0		12-17-1

\*1) 1.80 × Inverter rated current (A)

\*2) 1.50 × Inverter rated current (A)

Code	Name	Data range	Initial value	Note	Page
<a href="#">bb101</a>	First carrier frequency	[Ub-03]=02: Normal duty 0.5~16.0 (kHz) [Ub-03]=01: Low duty 0.5~12.0 (kHz) [Ub-03]=00: Very low duty 0.5~10.0 (kHz) *1)	2.0		12-12-1
bb102	First sprinkle carrier pattern selection	00 (Disabled)/01 (Pattern 1 enabled)/ 02 (Pattern 2 enabled)/ 03 (Pattern 3 enabled)/	00		12-12-4
<a href="#">bb103</a>	First automatic carrier frequency reduction selection	00 (Disabled)/01 (Enabled: current)/ 02 (Enabled: temperature)	00		12-12-2
bb-10	Auto-reset selection	00 (Disabled)/ 01 (Enabled with operation command OFF)/ 02 (Enable after the setting time)	00		
bb-11	Auto-reset alarm selection	00 (Output)/01 (Not output)	00		
bb-12	Auto-reset waiting time	0~600 (s)	2		
bb-13	Auto-reset count	0~10	3		
bb-20	Instantaneous power failure retry count	0~16/255	0		12-16-7
bb-21	Undervoltage retry count	0~16/255	0		12-16-7
bb-22	Overcurrent retry count	0~5	0		12-13-13
bb-23	Overvoltage retry count	0~5	0		12-13-15
bb-24	Selection of instantaneous power failure/undervoltage retry	00 (0Hz)/01 (Frequency matching)/ 02 (Frequency entrainment)/ 03 (Detection speed)/ 04 (Trip after frequency matching deceleration stop)	01		12-16-7
bb-25	Allowable instantaneous power failure time	0.3~25.0 (s)	1.0		12-16-7
bb-26	Retry wait time after instantaneous power failure/undervoltage	0.3~100.0 (s)	0.3		12-16-7
bb-27	Instantaneous power failure/undervoltage tripping selection during stop	00 (Disabled)/01 (Enabled at stop)/ 02 (Disabled at stop and deceleration stop)	00		12-16-7
bb-28	Overcurrent trip/retry selection	00 (0Hz)/01 (Frequency matching)/ 02 (Frequency entrainment)/ 03 (Detection speed)/ 04 (Trip after frequency matching deceleration stop)	01		12-13-13
bb-29	Retry wait time after overcurrent	0.3~100.0 (s)	0.3		12-13-13
bb-30	Overvoltage tripping retry selection	00 (0Hz)/01 (Frequency matching)/ 02 (Frequency entrainment)/ 03 (Detection speed)/ 04 (Trip after frequency matching deceleration stop)	01		12-13-15
bb-31	Overvoltage retry standby time	0.3~100.0 (s)	0.3		12-13-15
<a href="#">bb-40</a>	Restart after free-run stop	00 (0Hz)/01 (Frequency matching)/ 02 (Frequency entrainment)/ 03 (Detection speed)	00		12-14-12
<a href="#">bb-41</a>	Restart after the reset is released	00 (0Hz)/01 (Frequency matching)/ 02 (Frequency entrainment)/ 03 (Detection speed)	00		
<a href="#">bb-42</a>	Frequency matching lower limit setting	0.00~590.00 (Hz)	0.00		12-14-3

\*1) P1-01760-H (P1-750H) to P1-03160-H (P1-1320H) shall be as follows.

[Ub-03]=02: 0.5~10.0 (kHz)

[Ub-03]=00 or 01: 0.5~8.0 (kHz)

Code	Name	Data range	Initial value	Note	Page
<a href="#">bb-43</a>	Restarting level of frequency acquisition	(0.00 to 2.00) × Inverter rated current (A)	1.00 × Inverter rated current		12-14-6
<a href="#">bb-44</a>	Constant (frequency) for frequency acquisition restarting	0.10~30.00 (s)	0.50		12-14-6
<a href="#">bb-45</a>	Constant (voltage) for frequency acquisition restarting	0.10~30.00 (s)	0.50		12-14-6
<a href="#">bb-46</a>	Overcurrent suppression level for frequency pull-in restart	(0.20 to 2.00) × Inverter rated current (A)	1.00 × Inverter rated current		12-14-6
<a href="#">bb-47</a>	Start frequency selection for frequency pull-in restart	00 (Cutoff frequency)/ 01 (Maximum frequency)/ 02 (Setting frequency)	00		12-14-6
bb160	First overcurrent detection level	(0.20 to 2.20) x Inverter ND rated current	2.20 × Inverter ND rated current		12-16-5
<a href="#">bb-61</a>	Excessive voltage of accepted power	00 (Warning)/01 (Error)	00		
<a href="#">bb-62</a>	Incoming overvoltage level selection	(200V class) 300.0 - 410.0 (V) (400V class) 600.0 - 820.0 (V)	(200 V class) 390.0 (400V class) 780.0		
bb-64	Ground fault detection selection	00 (Disabled)/01 (Enabled)	01		18-15
<a href="#">bb-65</a>	Input phase loss selection	00 (Disabled)/01 (Enabled)	00		12-16-1
<a href="#">bb-66</a>	Output phase loss selection	00 (Disabled)/01 (Enabled)	00		12-16-2
<a href="#">bb-67</a>	Output phase loss detection sensitivity	1~100 (%)	10		12-16-2
<a href="#">bb-70</a>	Thermistor error level	0~10000 (Ω)	3000		
<a href="#">bb-80</a>	Over-speed error detection level setting	0.0~150.0 (%)	135.0		12-16-12
<a href="#">bb-81</a>	Over-speed error detection time	0.0~5.0 (s)	0.5		12-16-12
bb-82	Operation for speed deviation error	00 (Warning)/01 (Error)	00		12-16-11
bb-83	Speed deviation error detection level setting	0.0~100.0 (%)	15.0		12-16-11
bb-84	Speed deviation error detection time	0.0~5.0 (s)	0.5		12-16-11
bb-85	Behavior when the position deviation is abnormal	00 (Warning)/01 (Error)	00		12-17-18
bb-86	Abnormal position deviation detection level	0.0~65535 (×100pls)	4096		12-17-18
bb-87	Abnormal position deviation time	0.0~5.0 (s)	0.5		12-17-18
<a href="#">bb201</a>	Second carrier frequency	[Ub-03]=02: Normal duty 0.5~16.0 (kHz) [Ub-03]=01: Low duty 0.5~12.0 (kHz) [Ub-03]=00: Very low duty 0.5~10.0 (kHz) *1)	2.0		12-17-1
bb202	Second sprinkle carrier pattern selection	00 (Disabled)/ 01 (Pattern 1 enabled)/ 02 (Pattern 2 enabled)/ 03 (Pattern 3 enabled)/	00		12-17-1
<a href="#">bb203</a>	Second automatic carrier frequency reduction selection	00 (Disabled)/ 01 (Enabled: current)/ 02 (Enabled: temperature)	00		12-17-1
bb260	Second overcurrent detection level	(0.20 to 2.20) x Inverter ND rated current	2.20 × Inverter rated current		12-17-1

\*1) P1-01760-H (P1-750H) to P1-03160-H (P1-1320H) shall be as follows.

[Ub-03]=02: 0.5~10.0 (kHz)

[Ub-03]=00 or 01: 0.5~8.0 (kHz)

Code	Name	Data range	Initial value	Note	Page
<a href="#">bC110</a>	First electronic thermal level	(0.00 - 3.00) x Inverter rated current	1.00 x Inverter rated current		
<a href="#">bC111</a>	First electronic thermal characteristics selection	00 (Reduction characteristics)/ 01 (Constant torque characteristics)/ 02 (Arbitrary setting)	00 (*FF)/ 01 (*FEF, *FUF, *FCF)		
<a href="#">bC112</a>	First electronic thermal subtraction function selection	00 (Disabled)/01 (Enabled)	01		
<a href="#">bC113</a>	First electronic thermal subtraction time	1~1000 (s)	600		
<a href="#">bC-14</a>	Electronic thermal counter memory at power-off	00 (Disabled)/01 (Enabled)	01		
<a href="#">bC120</a>	First free electronic thermal frequency 1	0.00~[bC122] (Hz)	0.00		
<a href="#">bC121</a>	First free electronic thermal current 1	(0.00~3.00) x Inverter rated current	0.00		
<a href="#">bC122</a>	First free electronic thermal frequency 2	[bC120]~[bC124] (Hz)	0.00		
<a href="#">bC123</a>	First free electronic thermal current 2	(0.00~3.00) x Inverter rated current	0.00		
<a href="#">bC124</a>	First free electronic thermal frequency 3	[bC122]~590.00 (Hz)	0.00		
<a href="#">bC125</a>	First free electronic thermal current 3	(0.00~3.00) x Inverter rated current	0.00		
<a href="#">bC210</a>	Second electronic thermal level	(0.00~3.00) x Inverter rated current	1.00 x Inverter rated current		12-17-1
<a href="#">bC211</a>	Second electronic thermal characteristics selection	00 (Reduction characteristics)/ 01 (Constant torque characteristics)/ 02 (Arbitrary setting)	00 (*FF)/ 01 (*FEF, *FUF, *FCF)		12-17-1
<a href="#">bC212</a>	Second electronic thermal subtraction function selection	00 (Disabled)/01 (Enabled)	01		12-17-1
<a href="#">bC213</a>	Second electronic thermal subtraction time	1~1000 (s)	600		12-17-1
<a href="#">bC220</a>	First free electronic thermal frequency 2	0.00~[bC222] (Hz)	0.00		12-17-1
<a href="#">bC221</a>	First free electronic thermal current 2	(0.00 - 3.00) x Inverter rated current	0.00		12-17-1
<a href="#">bC222</a>	Second free electronic thermal frequency 2	[bC220]~[bC224] (Hz)	0.00		12-17-1
<a href="#">bC223</a>	Second free electronic thermal current 2	(0.00 - 3.00) x Inverter rated current	0.00		12-17-1
<a href="#">bC224</a>	Second free electronic thermal frequency 3	[bC222]~590.00 (Hz)	0.00		12-17-1
<a href="#">bC225</a>	Second free electronic thermal current 3	(0.00 - 3.00) x Inverter rated current	0.00		12-17-1

Code	Name	Data range	Initial value	Note	Page
bd-01	STO input indication selection	00 (With indication)/ 01 (Without indication)/02 (Trip)	00		21-29
bd-02	STO allowable input switch time	0.00~60.00 (s)	1.00		21-29
bd-03	STO indication selection within allowable input time	00 (With indication)/ 01 (Without indication)	00		21-29
bd-04	STO operation selection after allowable input time	00 (Retain only the condition)/ 01 (Disabled)/02 (Trip)	00		21-29

## ■ Parameter mode (code C)

Code	Name	Data range	Initial value	Note	Page
<a href="#">CA-01</a>	Input terminal function [1] selection	See <List of input terminal functions>	028		
<a href="#">CA-02</a>	Input terminal function [2] selection		015		
<a href="#">CA-03</a>	Input terminal function [3] selection		029		
<a href="#">CA-04</a>	Input terminal function [4] selection		032		
<a href="#">CA-05</a>	Input terminal function [5] selection		031		
<a href="#">CA-06</a>	Input terminal function [6] selection		003		
<a href="#">CA-07</a>	Input terminal function [7] selection		004		
<a href="#">CA-08</a>	Input terminal function [8] selection		002		
<a href="#">CA-09</a>	Input terminal function [9] selection		001		
<a href="#">CA-10</a>	Input terminal function [A] selection		033		
<a href="#">CA-11</a>	Input terminal function [B] selection		034		
<a href="#">CA-21</a>	Selection of Input terminal [1] a/b (NO/NC)	00 (Normally open)/ 01 (Normally closed)	00		
<a href="#">CA-22</a>	Selection of Input terminal [2] a/b (NO/NC)		00		
<a href="#">CA-23</a>	Selection of Input terminal [3] a/b (NO/NC)		00		
<a href="#">CA-24</a>	Selection of Input terminal [4] a/b (NO/NC)		00		
<a href="#">CA-25</a>	Selection of Input terminal [5] a/b (NO/NC)		00		
<a href="#">CA-26</a>	Selection of Input terminal [6] a/b (NO/NC)		00		
<a href="#">CA-27</a>	Selection of Input terminal [7] a/b (NO/NC)		00		
<a href="#">CA-28</a>	Selection of Input terminal [8] a/b (NO/NC)		00		
<a href="#">CA-29</a>	Selection of Input terminal [9] a/b (NO/NC)		00		
<a href="#">CA-30</a>	Selection of Input terminal [A] a/b (NO/NC)		00		
<a href="#">CA-31</a>	Selection of Input terminal [B] a/b (NO/NC)		00		
<a href="#">CA-41</a>	Input terminal [1] response time	0~400 (ms)	2		
<a href="#">CA-42</a>	Input terminal [2] response time		2		
<a href="#">CA-43</a>	Input terminal [3] response time		2		
<a href="#">CA-44</a>	Input terminal [4] response time		2		
<a href="#">CA-45</a>	Input terminal [5] response time		2		
<a href="#">CA-46</a>	Input terminal [6] response time		2		
<a href="#">CA-47</a>	Input terminal [7] response time		2		
<a href="#">CA-48</a>	Input terminal [8] response time		2		
<a href="#">CA-49</a>	Input terminal [9] response time		2		
<a href="#">CA-50</a>	Input terminal [A] response time		2		
<a href="#">CA-51</a>	Input terminal [B] response time		2		
<a href="#">CA-55</a>	Multi-step input determination time	0~2000 (ms)	0		

## &lt;List of input terminal functions&gt;

Function No.	Abbreviation	Function name	Page
000	no	Without allocation	-
001	FW	Normal rotation	
002	RV	Reverse rotation	
003	CF1	Multistage speed 1	
004	CF2	Multistage speed 2	
005	CF3	Multistage speed 3	
006	CF4	Multistage speed 4	
007	SF1	Multistage speed bit 1	
008	SF2	Multistage speed bit 2	
009	SF3	Multistage speed bit 3	
010	SF4	Multistage speed bit 4	
011	SF5	Multistage speed bit 5	
012	SF6	Multistage speed bit 6	
013	SF7	Multistage speed bit 7	
014	ADD	Addition of frequency	
015	SCHG	Switching of command	
016	STA	3-wire starting up	
017	STP	3-wire stopping	
018	FR	3-wire normal and reverse	
019	AHD	Retention of analog command	
020	FUP	Acceleration through remote operation	
021	FDN	Deceleration through remote operation	
022	UDC	Clearing of remote operation data	
023	F-OP	Forced switching of command	
024	SET	Second control	12-17-1
028	RS	Reset	
029	JG	Jogging	12-17-4
030	DB	Braking with external direct current	12-14-2 12-15-2
031	2CH	2-step acceleration/deceleration	12-8-3
032	FRS	Free-run stop	12-15-1
033	EXT	External abnormality	12-16-3
034	USP	Prevention of power restoration restarting	12-16-4
035	CS	Commercial switch	12-17-2
036	SFT	Soft-lock	9-24
037	BOK	Brake check	12-17-5
038	OLR	Switching of overload limit	12-13-2
039	KHC	Clearing of integrated input power	13-14

Function No.	Abbreviation	Function name	Page
040	OKHC	Clearing of integrated output power	13-15
041	PID	PID1 disabled	12-10-13
042	PIDC	Resetting of PID1 integration	12-10-13
043	PID2	PID2 disabled	12-10-27
044	PIDC2	Resetting of PID2 integration	12-10-27
045	PID3	PID3 disabled	12-10-27
046	PIDC3	Resetting of PID3 integration	12-10-27
047	PID4	PID4 disabled	12-10-27
048	PIDC4	Resetting of PID4 integration	12-10-27
051	SVC1	PID1 multistage target value 1	12-10-9
052	SVC2	PID1 multistage target value 2	12-10-9
053	SVC3	PID1 multistage target value 3	12-10-9
054	SVC4	PID1 multistage target value 4	12-10-9
055	PRO	Switching of PID gain	12-10-14
056	PIO	Switching of PID output	12-10-24
058	SLEP	Satisfaction of SLEEP condition	12-10-17
059	WAKE	Satisfaction of WAKE condition	12-10-17
060	TL	Validation of torque limit	12-11-8
061	TRQ1	Torque limit switchover 1	12-11-8
062	TRQ2	Torque limit switchover 2	12-11-8
063	PPI	PPI control switch	12-11-6
064	CAS	Control gain switch	12-11-4
066	FOC	Auxiliary excitation	12-14-13
067	ATR	Validation of torque control	12-11-13
068	TBS	Validation of torque bias	12-11-11
069	ORT	Orientation	12-17-22
071	LAC	Cancellation of LAD	12-8-11
072	PCLR	Clearing of positional deviation	12-17-25
073	STAT	Permission to inputting of Pulse string position command	12-17-20
074	PUP	Addition of positional bias	12-17-21
075	PDN	Subtraction of positional bias	12-17-21
076	CP1	Positional command selection 1	12-17-27
077	CP2	Positional command selection 2	12-17-27
078	CP3	Positional command selection 3	12-17-27
079	CP4	Positional command selection 4	12-17-27
080	ORL	Origin limit signal	12-17-29
081	ORG	Return-to-origin start up signal	12-17-29
082	FOT	Stopping of normal rotation driving	12-17-30
083	ROT	Stopping of reverse rotation driving	12-17-30
084	SPD	Switching of speed position	12-17-27
085	PSET	Presetting of positional data	12-17-30



Function No.	Abbreviation	Function name	Page
086	Mi1	General purpose input 1	16-6
087	Mi2	General purpose input 2	16-6
088	Mi3	General purpose input 3	16-6
089	Mi4	General purpose input 4	16-6
090	Mi5	General purpose input 5	16-6
091	Mi6	General purpose input 6	16-6
092	Mi7	General purpose input 7	16-6
093	Mi8	General purpose input 8	16-6
094	Mi9	General purpose input 9	16-6
095	Mi10	General purpose input 10	16-6
096	Mi11	General purpose input 11	16-6

Function No.	Abbreviation	Function name	Page
097	PCC	Clearing of pulse counter	
098	ECOM	Starting up of EzCOM	14-22
099	PRG	Starting of EzSQ program	16-6
100	HLD	Stopping of acceleration/deceleration	12-8-8
101	REN	Operation permission signal	
102	DISP	Fixation of display	
103	PLA	Pulse string input A	
104	PLB	Pulse string input B	
105	EMF	Emergency forced operation	12-17-13
107	COK	Contactora check signal	12-17-10
108	DTR	Data trace starting signal	16-8
109	PLZ	Pulse string input Z	12-17-22
110	TCH	Teaching signal	12-17-28

Code	Name	Data range	Initial value	Note	Page
<a href="#">CA-60</a>	FUP/FDN target selection	00 (Frequency command)/01 (PID1)	00		
<a href="#">CA-61</a>	FUP/FDN memory selection	00 (Not save)/01 (Save)	00		
<a href="#">CA-62</a>	FUP/FDN UDC mode selection	00 (0Hz)/01 (saved data)	00		
<a href="#">CA-64</a>	Acceleration time for FUP/FDN functions	0.00~3600.00 (s)	30.00		
<a href="#">CA-66</a>	Deceleration time for FUP/FDN functions	0.00~3600.00 (s)	30.00		
<a href="#">CA-70</a>	[F-OP] frequency command	01 (Ai1 terminal input)/ 02 (Ai2 terminal input)/ 03 (Ai3 terminal input)/ 04 (Ai4 terminal input)/ 05 (Ai5 terminal input)/ 06 (Ai6 terminal input)/ 07 (Parameter setting)/ 08 (RS 485)/09 (Option 1)/ 10 (Option 2)/11 (Option 3)/ 12 (Pulse string input: main unit)/ 13 (Pulse string input: P1-FB)/ 14 (Program function)/ 15 (PID calculation)/16 (QOP-VR)	01		
<a href="#">CA-71</a>	[F-OP] Operation command	00 ([FW]/[RV] terminal)/01 (3 wire)/ 02 (RUN key on operator keypad)/ 03 (RS485)/04 (Option 1)/ 05 (Option 2)/06 (Option 3)/	00		
CA-72	Reset selection	00 (On to Release Trip)/ 01 (Off to Release Trip)/ 02 (On to Release at Trip)/ 03 (Of to Release at Trip)	00		
CA-81	Encoder constant set-up	32~65535 (pls)	1024		12-9-35
CA-82	Encoder phase sequence selection	00 (Phase-A is leading)/ 01 (Phase-B is leading)	00		12-9-35
CA-83	Motor gear ratio's numerator	1~10000	1		12-9-35
CA-84	Motor gear ratio's denominator	1~10000	1		12-9-35
CA-90	Pulse string input (main body) detection target selection	00 (Pulse count)/ 01 (Frequency command)/ 02 (Speed feedback)/03 (Pulse count)	00		12-9-35
CA-91	Pulse string input (main body) mode selection	00 (90° phase difference)/ 01 (forward/reverse rotation command and rotation direction)/ 02 (forward/reverse rotation pulse string)	00		12-9-35
<a href="#">CA-92</a>	Pulse string frequency (main body) scale	0.05~32.00 (kHz)	25.00		
<a href="#">CA-93</a>	Pulse string frequency (main body) filter time constant	0.01~2.00 (s)	0.10		
<a href="#">CA-94</a>	Pulse string frequency (main body) bias size	-100.0~100.0 (%)	0.0		
<a href="#">CA-95</a>	Pulse string frequency (main body) upper detection limit	0.0~100.0 (%)	100.0		
<a href="#">CA-96</a>	Pulse string frequency (main body) lower detection limit	0.0~100.0 (%)	0.0		
<a href="#">CA-97</a>	Pulse count compare-match output ON level	0~65535	0		
<a href="#">CA-98</a>	Pulse count compare-match output OFF level	0~65535	0		
<a href="#">CA-99</a>	Maximum value for pulse count compare-match output	0~65535	0		

Code	Name	Data range	Initial value	Note	Page
<a href="#">Cb-01</a>	[Ai1] terminal input filter time constant	1~500 (ms)	16		
<a href="#">Cb-03</a>	[Ai1] terminal start amount	0.00~100.00 (%)	0.00		
<a href="#">Cb-04</a>	[Ai1] terminal end amount	0.00~100.00 (%)	100.00		
<a href="#">Cb-05</a>	[Ai1] terminal start ratio	0.0~[Cb-06] (%)	0.0		
<a href="#">Cb-06</a>	[Ai1] terminal end ratio	[Cb-05]~100.0 (%)	100.0		
<a href="#">Cb-07</a>	[Ai1] terminal start selection	00 (Start amount)/01 (0%)	01		
<a href="#">Cb-11</a>	[Ai2] terminal input filter time constant	1~500 (ms)	16		
<a href="#">Cb-13</a>	[Ai2] terminal start amount	0.00~100.00 (%)	0.00		
<a href="#">Cb-14</a>	[Ai2] terminal end amount	0.00~100.00 (%)	100.00		
<a href="#">Cb-15</a>	[Ai2] terminal start ratio	0.0~[Cb-16] (%)	20.0		
<a href="#">Cb-16</a>	[Ai2] terminal end ratio	[Cb-15]~100.0 (%)	100.0		
<a href="#">Cb-17</a>	[Ai2] terminal start selection	00 (Start amount)/01 (0%)	01		
<a href="#">Cb-21</a>	[Ai3] terminal input filter time constant	1~500 (ms)	16		
Cb-22	[Ai3] terminal selection	00 (Single)/ 01 (Added to Ai1/Ai2: with reversibility)/ 02 (Added to Ai1/Ai2: without reversibility)	00		
<a href="#">Cb-23</a>	[Ai3] terminal start amount	-100.00~100.00 (%)	-100.00		
<a href="#">Cb-24</a>	[Ai3] terminal end amount	-100.00~100.00 (%)	100.00		
<a href="#">Cb-25</a>	[Ai3] terminal start ratio	-100.0~[Cb-26]	-100.0		
<a href="#">Cb-26</a>	[Ai3] terminal end ratio	[Cb-25]~100.0	100.0		
Cb-30	[Ai1] voltage/current bias adjustment	-100.00~100.00	0.00		
Cb-31	[Ai1] voltage/current adjustment gain	0~200.00	100.00		
Cb-32	[Ai2] voltage/current bias adjustment	-100.00~100.00	0.00		
Cb-33	[Ai2] voltage/current adjustment gain	0~200.00	100.00		
Cb-34	[Ai3] voltage bias adjustment	-100.00~100.00	0.00		
Cb-35	[Ai3] voltage adjustment gain	0~200.00	100.00		
<a href="#">Cb-40</a>	Thermistor selection	00 (Disabled)/ 01 (PTC resistance value enabled)/ 02 (NTC resistance value enabled)	00		
Cb-41	Thermistor [TH+/TH-] adjustment	0.0~1000.0	100.0		

Code	Name	Data range	Initial value	Note	Page
<a href="#">Cb-51</a>	[QOP] VR input filter time constant	1~500 (ms)	16		
<a href="#">Cb-53</a>	[QOP] VR start amount	0.00~100.00 (%)	0.00		
<a href="#">Cb-54</a>	[QOP] VR end amount	0.00~100.00 (%)	100.00		
<a href="#">Cb-55</a>	[QOP] VR start ratio	0.0~[Cb-56] (%)	0.0		
<a href="#">Cb-56</a>	[QOP] VR end ratio	[Cb-55]~100.0 (%)	100.0		
<a href="#">Cb-57</a>	[QOP] VR start selection	00 (Start amount)/01 (0%)	01		

Code	Name	Data range	Initial value	Note	Page
<a href="#">CC-01</a>	Selection of output terminal function [11]	See <List of output terminal functions>	001		
<a href="#">CC-02</a>	Selection of output terminal function [12]		002		
<a href="#">CC-03</a>	Selection of output terminal function [13]		003		
<a href="#">CC-04</a>	Selection of output terminal function [14]		007		
<a href="#">CC-05</a>	Selection of output terminal function [15]		035		
<a href="#">CC-06</a>	Selection of output terminal function [16]		040		
<a href="#">CC-07</a>	Selection of output terminal function [AL]		017		
<a href="#">CC-11</a>	Selection of output terminal [11] a/b (NO/NC)	00 (Normally open)/ 01 (Normally closed)	00		
<a href="#">CC-12</a>	Selection of output terminal [12] a/b (NO/NC)		00		
<a href="#">CC-13</a>	Selection of output terminal [13] a/b (NO/NC)		00		
<a href="#">CC-14</a>	Selection of output terminal [14] a/b (NO/NC)		00		
<a href="#">CC-15</a>	Selection of output terminal [15] a/b (NO/NC)		00		
<a href="#">CC-16</a>	Selection of output terminal [16] a/b (NO/NC)		00		
<a href="#">CC-17</a>	Selection of output terminal [AL] a/b (NO/NC)		01		
<a href="#">CC-20</a>	Output terminal [11] on-delay time	0.00~100.00 (s)	0.00		
<a href="#">CC-21</a>	Output terminal [11] off-delay time	0.00~100.00 (s)	0.00		
<a href="#">CC-22</a>	Output terminal [12] on-delay time	0.00~100.00 (s)	0.00		
<a href="#">CC-23</a>	Output terminal [12] off-delay time	0.00~100.00 (s)	0.00		
<a href="#">CC-24</a>	Output terminal [13] on-delay time	0.00~100.00 (s)	0.00		
<a href="#">CC-25</a>	Output terminal [13] off-delay time	0.00~100.00 (s)	0.00		
<a href="#">CC-26</a>	Output terminal [14] on-delay time	0.00~100.00 (s)	0.00		
<a href="#">CC-27</a>	Output terminal [14] off-delay time	0.00~100.00 (s)	0.00		
<a href="#">CC-28</a>	Output terminal [15] on-delay time	0.00~100.00 (s)	0.00		
<a href="#">CC-29</a>	Output terminal [15] off-delay time	0.00~100.00 (s)	0.00		
<a href="#">CC-30</a>	Output terminal [16] on-delay time	0.00~100.00 (s)	0.00		
<a href="#">CC-31</a>	Output terminal [16] off-delay time	0.00~100.00 (s)	0.00		
<a href="#">CC-32</a>	Output terminal [AL] on-delay time	0.00~100.00 (s)	0.00		
<a href="#">CC-33</a>	Output terminal [AL] off-delay time	0.00~100.00 (s)	0.00		

## &lt;List of output terminal functions&gt;

Function No.	Abbreviation	Function name	Page
000	no	Without allocation	-
001	RUN	During operation	
002	FA1	When the constant speed is attained	
003	FA2	Equal to or above the set frequency	
004	FA3	Set frequency only	
005	FA4	Equal to or above the set frequency 2	
006	FA5	Set frequency only 2	
007	IRDY	Operation ready completion	
008	FWR	During normal rotation operation	
009	RVR	During reverse rotation operation	
010	FREF	Frequency command panel	
011	REF	Operation command panel	
012	SETM	Second control under selection	12-17-1
016	OPO	Optional output	14-41
017	AL	Alarm signal	
018	MJA	Severe failure signal	
019	OTQ	Excessive torque	12-11-9
020	IP	During instantaneous power failure	
021	UV	Under insufficient voltage	
022	TRQ	During torque limitation	12-11-8
023	IPS	During power failure deceleration	12-13-17
024	RNT	RUN time elapsed	
025	ONT	Power ON time elapsed	
026	THM	Electronic thermal warning	
027	THC	Electronic thermal warning	
029	WAC	Capacitor life advance notice	
030	WAF	Fan life advance notice	
031	FR	Operation command signal	
032	OHF	Cooling fin heating advance notice	
033	LOC	Low current signal	
034	LOC2	Low current signal 2	
035	OL	Overload advance notice	
036	OL2	Overload advance notice 2	
037	BRK	Brake release	12-17-5
038	BER	Brake abnormality	12-17-5
039	CON	Contact control	12-17-10
040	ZS	0 Hz detection signal	
041	DSE	Excessive speed deviation	12-16-11
042	PDD	Excessive positional deviation	12-17-21
043	POK	Positioning completed	12-17-22
044	PCMP	Pulse count compare-match output	
045	OD	PID excessive deviation	12-10-28
046	FBV	PID feedback comparison	12-10-29
047	OD2	PID2 excessive deviation	12-10-28
048	FBV2	PID2 feedback comparison	12-10-29

Function No.	Abbreviation	Function name	Page
049	NDC	Communication disconnection	14-5
050	Ai1Dc	Analog disconnection Ai1	
051	Ai2Dc	Analog disconnection Ai2	
052	Ai3Dc	Analog disconnection Ai3	
053	Ai4Dc	Analog disconnection Ai4	
054	Ai5Dc	Analog disconnection Ai5	
055	Ai6Dc	Analog disconnection Ai6	
056	WCAi1	Window comparator Ai1	
057	WCAi2	Window comparator Ai2	
058	WCAi3	Window comparator Ai3	
059	WCAi4	Window comparator Ai4	
060	WCAi5	Window comparator Ai5	
061	WCAi6	Window comparator Ai6	
062	LOG1	Result of logical operation 1	
063	LOG2	Result of logical operation 2	
064	LOG3	Result of logical operation 3	
065	LOG4	Result of logical operation 4	
066	LOG5	Result of logical operation 5	
067	LOG6	Result of logical operation 6	
068	LOG7	Result of logical operation 7	
069	MO1	General purpose output 1	
070	MO2	General purpose output 2	
071	MO3	General purpose output 3	
072	MO4	General purpose output 4	
073	MO5	General purpose output 5	
074	MO6	General purpose output 6	
075	MO7	General purpose output 7	
076	EMFC	Forced operation in process signal	12-17-13
077	EMBP	During-bypass-mode signal	12-17-15
078	WFT	Trace trigger stand-by signal	16-8
079	TRA	During-tracing signal	16-8
080	LBK	Operation panel battery insufficient	9-38
081	OVS	Excessive voltage of accepted power	
084	AC0	Alarm code bit 0	
085	AC1	Alarm code bit 1	
086	AC2	Alarm code bit 2	
087	AC3	Alarm code bit 3	
089	OD3	PID3 excessive deviation	12-10-28
090	FBV3	PID3 feedback comparison	12-10-29
091	OD4	PID4 excessive deviation	12-10-28
092	FBV4	PID4 feedback comparison	12-10-29
093	SSE	PID soft start abnormality	12-10-16

Code	Name	Data range	Initial value	Note	Page
<a href="#">CC-40</a>	Logical calculation output signal LOG1 selection 1	See <List of output terminal functions>	000		
<a href="#">CC-41</a>	Logical calculation output signal LOG1 selection 2	See <List of output terminal functions>	000		
<a href="#">CC-42</a>	Logical calculation output signal LOG1 operator selection	00 (AND)/01 (OR)/02 (XOR)	00		
<a href="#">CC-43</a>	Logical calculation output signal LOG2 selection 1	See <List of output terminal functions>	000		
<a href="#">CC-44</a>	Logical calculation output signal LOG2 selection 2	See <List of output terminal functions>	000		
<a href="#">CC-45</a>	Logical calculation output signal LOG2 operator selection	00 (AND)/01 (OR)/02 (XOR)	00		
<a href="#">CC-46</a>	Logical calculation output signal LOG3 selection 1	See <List of output terminal functions>	000		
<a href="#">CC-47</a>	Logical calculation output signal LOG3 selection 2	See <List of output terminal functions>	000		
<a href="#">CC-48</a>	Logical calculation output signal LOG3 operator selection	00 (AND)/01 (OR)/02 (XOR)	00		
<a href="#">CC-49</a>	Logical calculation output signal LOG4 selection 1	See <List of output terminal functions>	000		
<a href="#">CC-50</a>	Logical calculation output signal LOG4 selection 2	See <List of output terminal functions>	000		
<a href="#">CC-51</a>	Logical calculation output signal LOG4 operator selection	00 (AND)/01 (OR)/02 (XOR)	00		
<a href="#">CC-52</a>	Logical calculation output signal LOG5 selection 1	See <List of output terminal functions>	000		
<a href="#">CC-53</a>	Logical calculation output signal LOG5 selection 2	See <List of output terminal functions>	000		
<a href="#">CC-54</a>	Logical calculation output signal LOG5 operator selection	00 (AND)/01 (OR)/02 (XOR)	00		
<a href="#">CC-55</a>	Logical calculation output signal LOG6 selection 1	See <List of output terminal functions>	000		
<a href="#">CC-56</a>	Logical calculation output signal LOG6 selection 2	See <List of output terminal functions>	000		
<a href="#">CC-57</a>	Logical calculation output signal LOG6 operator selection	00 (AND)/01 (OR)/02 (XOR)	00		
<a href="#">CC-58</a>	Logical calculation output signal LOG7 selection 1	See <List of output terminal functions>	000		
<a href="#">CC-59</a>	Logical calculation output signal LOG7 selection 2	See <List of output terminal functions>	000		
<a href="#">CC-60</a>	Logical calculation output signal LOG7 operator selection	00 (AND)/01 (OR)/02 (XOR)	00		

Code	Name	Data range	Initial value	Note	Page
Cd-01	[FM] terminal output form selection	00 (PWM)/01 (frequency)	00		
Cd-02	[FM] terminal standard frequency (for PWM output)	0~3600 (kHz)	2880		
Cd-03	[FM] terminal output selection	See the List of output monitor functions	[dA-01]		
Cd-04	[Ao1] terminal output selection	See the List of output monitor functions	[dA-01]		
Cd-05	[Ao2] terminal output selection	See the List of output monitor functions	[dA-01]		
Cd-10	Analog monitor adjustment mode selection	00 (Disabled)/01 (Enabled)	00		
Cd-11	[FM] output filter time constant	1~500 (ms)	100		
Cd-12	[FM] output data type selection	00 (absolute value)/01 (with sign)	00		
Cd-13	[FM] bias adjustment	-100.0~100.0 (%)	0.0		
Cd-14	[FM] gain adjustment	-1000.0~1000.0 (%)	100.0		
Cd-15	[FM] output level in the adjustment mode	-100.0~100.0 (%)	100.0		
Cd-21	[Ao1] output filter time constant	1~500 (ms)	100		
Cd-22	[Ao1] output data type selection	00 (absolute value)/01 (with sign)	00		
Cd-23	[Ao1] bias adjustment	-100.0~100.0 (%)	0.0		
Cd-24	[Ao1] gain adjustment	-1000.0~1000.0 (%)	100.0		
Cd-25	[Ao1] output level in the adjustment mode	-100.0~100.0 (%)	100.0		
Cd-31	[Ao2] output filter time constant	1~500 (ms)	100		
Cd-32	[Ao2] output data type selection	00 (absolute value)/01 (with sign)	00		
Cd-33	[Ao2] bias adjustment	-100.0~100.0 (%)	20.0		
Cd-34	[Ao2] gain adjustment	-1000.0~1000.0 (%)	100.0		
Cd-35	[Ao2] output level in the adjustment mode	-100.0~100.0 (%)	100.0		

## &lt;List of output monitor functions&gt;

Monitor No.	Function
dA-01	Output frequency monitor
dA-02	Output current monitor
dA-04	Frequency command after calculation
dA-08	Speed detection value monitor
dA-12	Output frequency monitor (with sign)
dA-14	Frequency upper limit monitor
dA-15	Torque command monitor after calculation
dA-16	Torque limit monitor
dA-17	Output torque monitor
dA-18	Output voltage monitor
dA-30	Input power monitor
dA-34	Output power monitor
dA-38	Motor temperature monitor
dA-40	DC voltage monitor
dA-41	BRD load factor monitor
dA-42	Electronic thermal duty ratio monitor MTR
dA-43	Electronic thermal duty ratio monitor CTL
dA-61	Analog input [Ai1] monitor
dA-62	Analog input [Ai2] monitor
dA-63	Analog input [Ai3] monitor
dA-64	Analog input [Ai4] monitor
dA-65	Analog input [Ai5] monitor
dA-66	Analog input [Ai6] monitor
dA-70	Pulse string input monitor main body
dA-71	Pulse string input monitor option
db-18	Analog output monitor YA0
db-19	Analog output monitor YA1
db-20	Analog output monitor YA2
db-21	Analog output monitor YA3
db-22	Analog output monitor YA4
db-23	Analog output monitor YA5

Monitor No.	Function
db-30	PID1 feedback data 1 monitor
db-32	PID1 feedback data 2 monitor
db-34	PID1 feedback data 3 monitor
db-36	PID2 feedback data monitor
db-38	PID3 feedback data monitor
db-40	PID4 feedback data monitor
db-42	PID1 target value monitor after calculation
db-44	PID1 feedback data
db-50	PID1 output monitor
db-51	PID1 deviation monitor
db-52	PID1 deviation 1 monitor
db-53	PID1 deviation 2 monitor
db-54	PID1 deviation 3 monitor
db-55	PID2 output monitor
db-56	PID2 deviation monitor
db-57	PID3 output monitor
db-58	PID3 deviation monitor
db-59	PID4 output monitor
db-60	PID4 deviation monitor
db-64	PID feed-forward monitor
dC-15	Cooling fin temperature monitor
FA-01	Main speed command
FA-02	Auxiliary speed command
FA-15	Torque command monitor
FA-16	Torque bias monitor
FA-30	PID1 target value 1
FA-32	PID1 target value 2
FA-34	PID1 target value 3
FA-36	PID2 target value
FA-38	PID3 target value
FA-40	PID4 target value



Code	Name	Data range	Initial value	Note	Page
<a href="#">CE101</a>	First low current signal output mode selection	00 (During acceleration/deceleration, at constant speed)/ 01 (Only at constant speed)	01		
<a href="#">CE102</a>	First low current detection level 1	(0.00 to 2.00) × Inverter rated current	1.00 × Inverter rated current		
<a href="#">CE103</a>	First low current detection level 2	(0.00 to 2.00) × Inverter rated current	1.00 × Inverter rated current		
<a href="#">CE105</a>	First overload prewarning signal output mode selection	00 (During acceleration/deceleration, at constant speed)/ 01 (Only at constant speed)	01		
<a href="#">CE106</a>	First overload prewarning level 1	(0.00 to 2.00) × Inverter rated current	1.00 × Inverter rated current		
<a href="#">CE107</a>	First overload prewarning level 2	(0.00 to 2.00) × Inverter rated current	1.00 × Inverter rated current		
<a href="#">CE-10</a>	Acceleration reaching frequency 1	0.00~590.00 (Hz)	0.00		
<a href="#">CE-11</a>	Deceleration reaching frequency 1	0.00~590.00 (Hz)	0.00		
<a href="#">CE-12</a>	Acceleration reaching frequency 2	0.00~590.00 (Hz)	0.00		
<a href="#">CE-13</a>	Deceleration reaching frequency 2	0.00~590.00 (Hz)	0.00		
<a href="#">CE120</a>	First over torque level (normal powered)	0.0~500.0 (%)	100.0		12-11-9
<a href="#">CE121</a>	First over torque level (reverse regenerative)	0.0~500.0 (%)	100.0		
<a href="#">CE122</a>	First over torque level (reverse powered)	0.0~500.0 (%)	100.0		
<a href="#">CE123</a>	First over torque level (normal regenerative)	0.0~500.0 (%)	100.0		
<a href="#">CE-30</a>	Electronic thermal warning level (MTR)	0.00~100.00 (%)	80.00		
<a href="#">CE-31</a>	Electronic thermal warning level (CTL)	0.00~100.00 (%)	80.00		
<a href="#">CE-33</a>	0-Hz detection value level	0.00~100.00 (%)	0.50		
<a href="#">CE-34</a>	Cooling fin heating prewarning level	0~200 (°C)	120		
<a href="#">CE-36</a>	RUN time/power-on time level	0~100000 (hr)	0		

Code	Name	Data range	Initial value	Note	Page
<a href="#">CE-40</a>	Window comparator [Ai1] upper limit level	0~100 (%)	100		
<a href="#">CE-41</a>	Window comparator [Ai1] lower limit level	0~100 (%)	0		
<a href="#">CE-42</a>	Window comparator [Ai1] hysteresis range	0~10 (%)	0		
<a href="#">CE-43</a>	Window comparator [Ai2] upper limit level	0~100 (%)	100		
<a href="#">CE-44</a>	Window comparator [Ai2] lower limit level	0~100 (%)	0		
<a href="#">CE-45</a>	Window comparator [Ai2] hysteresis range	0~10 (%)	0		
<a href="#">CE-46</a>	Window comparator [Ai3] lower limit level	-100~100 (%)	100		
<a href="#">CE-47</a>	Window comparator [Ai3] lower limit level	-100~100 (%)	-100		
<a href="#">CE-48</a>	Window comparator [Ai3] hysteresis range	0~10 (%)	0		
<a href="#">CE-50</a>	[Ai1] operation level at disconnection	0~100 (%)	0		
<a href="#">CE-51</a>	[Ai1] operation level selection at disconnection	00 (Disabled)/ 01 (Enabled: out of range) 02 (Enabled: within the range)	00		
<a href="#">CE-52</a>	[Ai2] operation level at disconnection	0~100(%)	0		
<a href="#">CE-53</a>	[Ai2] operation level selection at disconnection	00 (Disabled)/ 01 (Enabled: out of range)/ 02 (Enabled: within the range)	00		
<a href="#">CE-54</a>	[Ai3] operation level at disconnection	-100~100(%)	0		
<a href="#">CE-55</a>	[Ai3] operation level selection at disconnection	00 (Disabled)/ 01 (Enabled: out of range)/ 02 (Enabled: within the range)	00		

Code	Name	Data range	Initial value	Note	Page
<a href="#">CE201</a>	Second low current signal output mode selection	00 (During acceleration/deceleration, at constant speed)/ 01 (Only at constant speed)	01		12-17-1
<a href="#">CE202</a>	First low current detection level 2	(0.00 to 2.00) × Inverter rated current	1.00 × Inverter rated current		
<a href="#">CE203</a>	Second low current detection level 2	(0.00 to 2.00) × Inverter rated current	1.00 × Inverter rated current		
<a href="#">CE205</a>	Second overload prewarning signal output mode selection	00 (During acceleration/deceleration, at constant speed)/ 01 (Only at constant speed)	01		
<a href="#">CE206</a>	First overload prewarning level 2	(0.00 to 2.00) × Inverter rated current	1.00 × Inverter rated current		
<a href="#">CE207</a>	Second overload prewarning level 2	(0.00 to 2.00) × Inverter rated current	1.00 × Inverter rated current		
<a href="#">CE220</a>	Second over torque level (normal powered)	0.0~500.0 (%)	100.0		
<a href="#">CE221</a>	Second over torque level (reverse regenerative)	0.0~500.0 (%)	100.0		
<a href="#">CE222</a>	Second over torque level (reverse powered)	0.0~500.0 (%)	100.0		
<a href="#">CE223</a>	Second over torque level (normal regenerative)	0.0~500.0 (%)	100.0		

Code	Name	Data range	Initial value	Note	Page
CF-01	Communication transmission speed selection (baudrate selection)	03 (2400bps)/04 (4800bps)/ 05 (9600bps)/06 (19.2kbps)/ 07 (38.4kbps)/08 (57.6kbps)/ 09 (76.8kbps)/10 (115.2kbps)	05		14-5
<a href="#">CF-02</a>	Communication station number selection	1~247	1		
<a href="#">CF-03</a>	Communication parity selection	00 (Without parity)/ 01 (Even number parity)/ 02 (Odd number parity)	00		
<a href="#">CF-04</a>	Communication stop bit selection	01 (1bit)/02 (2bit)	01		
<a href="#">CF-05</a>	Communication error selection	00 (Error)/ 01 (Trip after deceleration stop)/ 02 (Ignore)/03 (Free run)/ 04 (Deceleration stop)	02		
<a href="#">CF-06</a>	Communication timeout time	0.00~100.00 (s)	0.00		
<a href="#">CF-07</a>	Communication waiting time	0~1000 (ms)	2		
<a href="#">CF-08</a>	Communication method selection	01 (Modbus-RTU)/02 (EzCOM)/ 03 (EzCOM management)	01		14-5 14-22
CF-11	Resister dataA, V↔% conversion function	00 (A,V)/01 (%)	00		14-26
CF-20	EzCOM start INV station number	01~08	01		14-22
CF-21	EzCOM stop INV station number	01~08	01		
CF-22	EzCOM start selection	00 (ECOM) terminal/ 01 (Modbus spec)	00		
<a href="#">CF-23</a>	Numer of EzCOM data sets	01~05	05		14-23
<a href="#">CF-24</a>	EzCOM transmission destination station number 1	1~247	1		
<a href="#">CF-25</a>	EzCOM transmission destination register 1	0000~FFFF	0000		
<a href="#">CF-26</a>	EzCOM transmission source register 1	0000~FFFF	0000		
<a href="#">CF-27</a>	EzCOM transmission destination station number 2	1~247	2		
<a href="#">CF-28</a>	EzCOM transmission destination register 2	0000~FFFF	0000		
<a href="#">CF-29</a>	EzCOM transmission source register 2	0000~FFFF	0000		
<a href="#">CF-30</a>	EzCOM transmission destination station number 3	1~247	3		
<a href="#">CF-31</a>	EzCOM transmission destination register 3	0000~FFFF	0000		
<a href="#">CF-32</a>	EzCOM transmission source register 3	0000~FFFF	0000		
<a href="#">CF-33</a>	EzCOM transmission destination station number 4	1~247	4		
<a href="#">CF-34</a>	EzCOM transmission destination register 4	0000~FFFF	0000		
<a href="#">CF-35</a>	EzCOM transmission source register 4	0000~FFFF	0000		
<a href="#">CF-36</a>	EzCOM transmission destination station number 5	1~247	5		
<a href="#">CF-37</a>	EzCOM transmission destination register 5	0000~FFFF	0000		
<a href="#">CF-38</a>	EzCOM transmission source register 5	0000~FFFF	0000		
<a href="#">CF-50</a>	USB station number selection	1~247	1		16-2

## ■ Parameter mode (code H)

Code	Name	Data range	Initial value	Note	Page
HA-01	Auto-tuning selection	00 (Disabled)/01 (Non-rotation)/ 02 (Rotation)/03 (IVMS)	00		
HA-02	Operation command for auto-tuning	00 (RUN key on the operator keypad)/ 01 ([AA111]/[AA211])	00		
HA-03	Online tuning selection	00 (Disabled)/01 (Enabled)	00		
HA110	First stability constant	0~1000 (%)	100		12-9-11
HA115	First speed response	0~1000 (%)	100		12-9-12
HA120	First gain switch selection	00 ([CAS] terminal)/ 01 (setting switch)	00		
HA121	First gain switch time	0~10000 (ms)	100		
HA122	First gain switch intermediate frequency 1	0.00~590.00 (Hz)	0.00		
HA123	First gain switch intermediate frequency 2	0.00~590.00 (Hz)	0.00		
HA124	First gain mapping maximum frequency	0.00~590.00 (Hz)	0.00		
HA125	First gain mapping P gain 1	0.0~1000.0 (%)	100.0		
HA126	First gain mapping I gain 1	0.0~1000.0 (%)	100.0		
HA127	First gain mapping P control P gain 1	0.0~1000.0 (%)	100.0		
HA128	First gain mapping P gain 2	0.0~1000.0 (%)	100.0		
HA129	First gain mapping I gain 2	0.0~1000.0 (%)	100.0		
HA130	First gain mapping P control P gain 2	0.0~1000.0 (%)	100.0		
HA131	First gain mapping P gain 3	0.0~1000.0 (%)	100.0		
HA132	First gain mapping I gain 3	0.0~1000.0 (%)	100.0		
HA133	First gain mapping P gain 4	0.0~1000.0 (%)	100.0		
HA134	First gain mapping I gain 4	0.0~1000.0 (%)	100.0		
HA210	Second stability constant	0~1000 (%)	100		
HA215	Second speed response	0~1000 (%)	100		
HA220	Second gain switch selection	00 ([CAS] terminal)/ 01 (setting switch)	00		
HA221	Second gain switch time	0~10000 (ms)	100		
HA222	First gain switch intermediate frequency 2	0.00~590.00 (Hz)	00		
HA223	Second gain switch intermediate frequency 2	0.00~590.00 (Hz)	100		
HA224	Second gain mapping maximum frequency	0.00~590.00 (Hz)	0.00		
HA225	First gain mapping P gain 2	0.0~1000.0 (%)	100.0		
HA226	First gain mapping I gain 2	0.0~1000.0 (%)	100.0		
HA227	First gain mapping P control P gain 2	0.0~1000.0 (%)	100.0		
HA228	Second gain mapping P gain 2	0.0~1000.0 (%)	100.0		
HA229	Second gain mapping I gain 2	0.0~1000.0 (%)	100.0		
HA230	Second gain mapping P control P gain 2	0.0~1000.0 (%)	100.0		
HA231	Second gain mapping P gain 3	0.0~1000.0 (%)	100.0		
HA232	Second gain mapping I gain 3	0.0~1000.0 (%)	100.0		
HA233	Second gain mapping P gain 4	0.0~1000.0 (%)	100.0		
HA234	Second gain mapping I gain 4	0.0~1000.0 (%)	100.0		

Code	Name	Data range	Initial value	Note	Page
Hb102	First IM motor capacity selection	0.01~160.00 (kW)	*1)		
Hb103	Selection of number of first IM motor poles	2 to 48 (poles)	4		
Hb104	First IM base frequency	10.00~590.00 (Hz)	60.00 (*FF, *FUF)/ 50.00 (*FEF, *FCF)		
Hb105	First IM maximum frequency	10.00~590.00 (Hz)	60.00 (*FF, *FUF)/ 50.00 (*FEF, *FCF)		
Hb106	First IM motor's rated voltage	1~1000 (V)	200 V class: 200 (*FF)/ 230 (*FEF, *FUF, *FCF) 400V class: 400 (*FF, *FEF, *FCF)/ 460 (*FUF)		
Hb108	First IM motor's rated current	0.01~10000.00 (A)	*1)		
Hb110	First IM motor constant R1	0.000001~1000.000000 (Ω)	*1)		
Hb112	First IM motor constant R2	0.000001~1000.000000 (Ω)	*1)		
Hb114	First motor constant L	0.000001~1000.000000 (mH)	*1)		
Hb116	First IM motor constant I <sub>o</sub>	0.01~10000.00 (A)	*1)		
Hb118	First IM motor constant J	0.00001~10000.000000 (kgm <sup>2</sup> )	*1)		
Hb130	First minimum frequency	0.10~10.00 (Hz)	0.50		12-14-1
<a href="#">Hb131</a>	First reduced voltage start time	0~2000 (ms)	36		12-14-1
Hb140	First manual torque boost operation mode selection	00 (Disabled)/ 01 (Always enabled)/ 02 (Enabled only for forward revolution)/ 03 (Enabled only for reverse revolution)	01		12-9-8
<a href="#">Hb141</a>	First amount of manual torque boost	0.0~20.0 (%)	0.0		12-9-8
<a href="#">Hb142</a>	First manual torque boost break point	0.0~50.0 (%)	0.0		12-9-8
Hb145	First energy-saving operation selection	00 (Disabled)/01 (Enabled)	00		12-9-7
<a href="#">Hb146</a>	First energy-saving response/accuracy adjustment	0.0~100.0(%)	50.0		12-9-7
Hb150	First free V/f frequency 1	0.00~[Hb152] (Hz)	0.00		12-9-6
Hb151	First free V/f voltage 1	0.0~1000.0 (V)	0.0		
Hb152	First free V/f frequency 2	[Hb150]~[Hb154] (Hz)	0.00		
Hb153	First free V/f voltage 2	0.0~1000.0 (V)	0.0		
Hb154	First free V/f frequency 3	[Hb152]~[Hb156] (Hz)	0.00		
Hb155	First free V/f voltage 3	0.0~1000.0 (V)	0.0		
Hb156	First free V/f frequency 4	[Hb154]~[Hb158] (Hz)	0.00		
Hb157	First free V/f voltage 4	0.0~1000.0 (V)	0.0		
Hb158	First free V/f frequency 5	[Hb156]~[Hb160] (Hz)	0.00		
Hb159	First free V/f voltage 5	0.0~1000.0 (V)	0.0		
Hb160	First free V/f frequency 6	[Hb158]~[Hb162] (Hz)	0.00		
Hb161	First free V/f voltage 6	0.0~1000.0 (V)	0.0		
Hb162	First free V/f frequency 7	[Hb160]~[Hb164] (Hz)	0.00		
Hb163	First free V/f voltage 7	0.0~1000.0 (V)	0.0		
<a href="#">Hb170</a>	First slip compensation P gain with sensor (V/f with sensor)	0~1000 (%)	100		12-9-27
<a href="#">Hb171</a>	First slip compensation I gain with sensor (V/f with sensor)	0~1000 (%)	100		12-9-27
<a href="#">Hb180</a>	First output voltage gain	0~255 (%)	100		12-9-11

\*1) Varies depending on inverter models and settings of duty rating.

Code	Name	Data range	Initial value	Note	Page
Hb202	Second IM motor capacity selection	0.01~160.00 (kW)	*1)		12-17-1
Hb203	Selection of number of second IM motor poles	2 to 48 (poles)	4		
Hb204	Second IM base frequency	10.00~590.00 (Hz)	60.00 (*FF, *FUF)/ 50.00 (*FEF, *FCF)		
Hb205	Second IM maximum frequency	10.00~590.00 (Hz)	60.00 (*FF, *FUF)/ 50.00 (*FEF, *FCF)		
Hb206	Second IM motor's rated voltage	1~1000 (V)	200 V class: 200 (*FF)/ 230 (*FEF, *FUF, *FCF) 400V class: 400 (*FF, *FEF, *FCF)/ 460 (*FUF)		
Hb208	Second IM motor's rated current	0.01~10000.00 (A)	*1)		
Hb210	Second IM motor constant R1	0.000001~1000.000000 (Ω)	*1)		
Hb212	Second IM motor constant R2	0.000001~1000.000000 (Ω)	*1)		
Hb214	Second IM motor constant L	0.000001~1000.000000 (mH)	*1)		
Hb216	Second IM motor constant lo	0.01~10000.00 (A)	*1)		
Hb218	Second IM motor constant J	0.00001~10000.00000 (kgm2)	*1)		
Hb230	Second minimum frequency	0.10~10.00 (Hz)	0.50		
<u>Hb231</u>	Second reduced voltage start time	0~2000 (ms)	36		
Hb240	Second manual torque boost operation mode selection	00 (Disabled)/ 01 (Always enabled)/ 02 (Enabled only for forward revolution)/ 03 (Enabled only for reverse revolution)	01		
<u>Hb241</u>	Second amount of manual torque boost	0.0~20.0 (%)	0.0		
<u>Hb242</u>	Second manual torque boost break point	0.0~50.0 (%)	0.0		
Hb245	Second energy-saving operation selection	00 (Disabled)/01 (Enabled)	00		
<u>Hb246</u>	Second energy-saving response/accuracy adjustment	0.0~100.0 (%)	50.0		
Hb250	First free V/f frequency 2	0.00~[Hb252] (Hz)	0		
Hb251	First free V/f voltage 2	0.0~1000.0 (V)	0.0		
Hb252	Second free V/f frequency 2	[Hb250]~[Hb254] (Hz)	0.00		
Hb253	Second free V/f voltage 2	0.0~1000.0 (V)	0.0		
Hb254	Second free V/f frequency 3	[Hb252]~[Hb256] (Hz)	0.00		
Hb255	Second free V/f voltage 3	0.0~1000.0 (V)	0.0		
Hb256	Second free V/f frequency 4	[Hb254]~[Hb258] (Hz)	0.00		
Hb257	Second free V/f voltage 4	0.0~1000.0 (V)	0.0		
Hb258	Second free V/f frequency 5	[Hb256]~[Hb260] (Hz)	0.00		
Hb259	Second free V/f voltage 5	0.0~1000.0 (V)	0.0		
Hb260	Second free V/f frequency 6	[Hb258]~[Hb262] (Hz)	0.00		
Hb261	Second free V/f voltage 6	0.0~1000.0 (V)	0.0		
Hb262	Second free V/f frequency 7	[Hb260]~[Hb264] (Hz)	0.00		
Hb263	Second free V/f voltage 7	0.0~1000.0 (V)	0.0		
<u>Hb270</u>	Second slip compensation I gain with sensor (V/f with sensor)	0~1000 (%)	100		
<u>Hb271</u>	Second slip compensation I gain with sensor (V/f with sensor)	0~1000 (%)	100		
<u>Hb280</u>	Second output voltage gain	0~255 (%)	100		

\*1) Varies depending on inverter models and settings of duty rating.

Code	Name	Data range	Initial value	Note	Page
<a href="#">HC101</a>	First automatic torque boost voltage compensation gain	0~255 (%)	100		12-9-9
<a href="#">HC102</a>	First automatic torque boost slip compensation gain	0~255 (%)	100		
<a href="#">HC110</a>	First zero-speed range limiter (IM-0Hz)	0~100 (%)	80		12-9-14
<a href="#">HC111</a>	First amount of boost at the start (IM-SLV)	0~50 (%)	0		12-9-12
<a href="#">HC112</a>	First amount of boost at the start (IM-oHz)	0~50 (%)	10		12-9-14
HC113	First selection of secondary-resistance correction that is conducted or not.	00 (Disabled)/01 (Enabled)	00		12-9-12
<a href="#">HC114</a>	First selection of reversal prevention	00 (Disabled)/01 (Enabled)	00		
<a href="#">HC120</a>	First time constant for torque current command filter	0~100 (ms)	2		
<a href="#">HC121</a>	First speed feed forward gain	0~1000	0		
<a href="#">HC201</a>	Second automatic torque boost voltage compensation gain	0~255 (%)	100		12-17-1
<a href="#">HC202</a>	Second automatic torque boost slip compensation gain	0~255 (%)	100		
<a href="#">HC210</a>	Second zero-speed range limiter (IM-0Hz)	0~100 (%)	80		
<a href="#">HC211</a>	Second amount of boost at the start (IM-SLV)	0~50 (%)	0		
<a href="#">HC212</a>	Second amount of boost at the start (IM-oHz)	0~50 (%)	10		
HC213	Second selection of whether a secondary-resistance correction is to be conducted.	00 (Disabled)/01 (Enabled)	00		
<a href="#">HC214</a>	Second selection of reversal prevention	00 (Disabled)/01 (Enabled)	00		
<a href="#">HC220</a>	Second time constant for torque current command filter	0~100 (ms)	2		
<a href="#">HC221</a>	Second speed feed forward gain	0~1000	0		

Code	Name	Data range	Initial value	Note	Page
Hd102	First SM (PMM) motor capacity selection	0.01~160.00 (kW)	*1)		
Hd103	First selection of number of SM (PMM) motor poles	2 to 48 (poles)	*1)		
Hd104	First SM (PMM) base frequency	10.00~590.00 (Hz)	*1)		
Hd105	First SM (PMM) maximum frequency	10.00~590.00 (Hz)	*1)		
Hd106	First SM (PMM) motor's rated voltage	1~1000 (V)	*1)		
Hd108	First SM (PMM) motor's rated current	0.01~10000.00 (A)	*1)		
Hd110	First SM (PMM) motor's constant R	0.000001~1000.000000 ( $\Omega$ )	*1)		
Hd112	First SM (PMM) motor's constant Ld	0.000001~1000.000000 (mH)	*1)		
Hd114	First SM (PMM) motor's constant Lq	0.000001~1000.000000 (mH)	*1)		
Hd116	First SM (PMM) motor's constant Ke	0.1~100000.0 (mVs/rad)	*1)		
Hd118	First SM (PMM) motor's constant J	0.00001~10000.00000 (kgm <sup>2</sup> )	*1)		

\*1) Varies depending on inverter models and settings of duty rating.



Code	Name	Data range	Initial value	Note	Page
<a href="#">Hd130</a>	First SM (PMM) minimum frequency	0~50 (%)	8		12-9-20
<a href="#">Hd131</a>	First SM (PMM) no-load current	0~100 (%)	10		
Hd132	First SM (PMM) start method selection	00 (Position estimation disabled)/ 01 (Position estimation enabled)	00		
Hd133	First SM (PMM) initial position estimation zero-V stand-by times	0~255	10		
Hd134	First SM (PMM) initial position estimation detection stand-by times	0~255	10		
Hd135	First SM (PMM) initial position estimation detection times	0~255	30		
Hd136	First SM (PMM) initial position estimation voltage gain	0~200 (%)	100		
Hd137	First initial position estimation magnetic-pole position offset	0~359 (deg)	0		

Code	Name	Data range	Initial value	Note	Page
<a href="#">Hd-41</a>	IVMS carrier frequency	0.5~16.0 (kHz)	2.0		12-9-22
<a href="#">Hd-42</a>	Filter gain of IVMS detection current	0~1000	100		
Hd-43	Open-phase voltage detection gain selection.	00 (Gain 0)/01 (Gain 1)/ 02 (Gain 2)/03 (Gain 3)	00		
<a href="#">Hd-44</a>	Selection of open-phase switch threshold correction.	00 (Disabled)/01 (Enabled)	01		
<a href="#">Hd-45</a>	Speed control P gain	0~1000	100		
<a href="#">Hd-46</a>	Speed control I gain	0~10000	100		
<a href="#">Hd-47</a>	Waiting time for open-phase switching	0~1000	15		
<a href="#">Hd-48</a>	Restriction on the rotation-direction determination	00 (Disabled)/01 (Enabled)	01		
<a href="#">Hd-49</a>	Adjustment of the timing for detecting the open-phase voltage	0~1000	10		
<a href="#">Hd-50</a>	Minimum pulse-width adjustment	0~1000	100		
<a href="#">Hd-51</a>	Current limit of IVMS threshold	0~255	100		
<a href="#">Hd-52</a>	IVMS threshold gain	0~255	100		
<a href="#">Hd-58</a>	IVMS carrier-frequency switching start/finish point	0~50 (%)	5		

Code	Name	Data range	Initial value	Note	Page
Hd202	Second SM (PMM) motor capacity selection	0.01~160.00 (kW)	*1)		12-17-1
Hd203	Second selection of number of SM (PMM) motor poles	2 to 48 (poles)	*1)		
Hd204	Second SM (PMM) base frequency	10.00~590.00 (Hz)	*1)		
Hd205	Second SM (PMM) maximum frequency	10.00~590.00 (Hz)	*1)		
Hd206	Second SM (PMM) motor's rated voltage	1~1000 (V)	*1)		
Hd208	Second SM (PMM) motor's rated current	0.01~10000.00 (A)	*1)		
Hd210	Second SM (PMM) motor's constant R	0.000001~1000.000000 ( $\Omega$ )	*1)		
Hd212	Second SM (PMM) motor's constant Ld	0.000001~1000.000000 (mH)	*1)		
Hd214	Second SM (PMM) motor's constant Lq	0.000001~1000.000000 (mH)	*1)		
Hd216	Second SM (PMM) motor's constant Ke	0.1~100000.0 (mVs/rad)	*1)		
Hd218	Second SM (PMM) motor's constant J	0.00001~10000.000000 (kgm <sup>2</sup> )	*1)		

\*1) Varies depending on inverter models and settings of duty rating.

Code	Name	Data range	Initial value	Note	Page
<u>Hd230</u>	Second SM (PMM) minimum frequency	0~50 (%)	8		12-17-1
<u>Hd231</u>	Second SM (PMM) no-load current	0~100 (%)	10		
Hd232	Second SM (PMM) start method selection	00 (Position estimation disabled)/ 01 (Position estimation enabled)	00		
Hd233	Second SM (PMM) initial position estimation zero-V stand-by times	0~255	10		
Hd234	Second SM (PMM) initial position estimation detection stand-by times	0~255	10		
Hd235	Second SM (PMM) initial position estimation detection times	0~255	30		
Hd236	Second SM (PMM) initial position estimation voltage gain	0~200 (%)	100		
Hd237	Second initial position estimation magnetic-pole position offset	0~359 (deg)	0		

## ■ Parameter mode (code o)

Code	Name	Data range	Initial value	Note	Page
<a href="#">oA-10</a>	Operation selection when option error occurs (slot 1)	00 (Error)/01 (Continue operation)	00		*1)
<a href="#">oA-11</a>	Communication monitoring timer setting (slot1)	0.00~100.00 (s)	1.00		*1)
oA-12	Operation setting at the time of communication error (slot1)	00 (Error)/ 01 (Trip after deceleration stop)/ 02 (Ignore)/03 (Free run)/ 04 (Deceleration stop)	01		*1)
oA-13	Selection of operation command behavior at start (slot 1)	00 (Operation command disabled)/ 01 (Operation command enabled)	00		*1)
<a href="#">oA-20</a>	Operation selection when option error occurs (slot 2)	00 (Error)/01 (Continue operation)	00		*1)
<a href="#">oA-21</a>	Communication monitoring timer setting (slot 2)	0.00~100.00 (s)	1.00		*1)
oA-22	Operation setting at the time of communication error (slot 2)	00 (Error)/ 01 (Trip after deceleration stop)/ 02 (Ignore)/03 (Free run)/ 04 (Deceleration stop)	01		*1)
oA-23	Selection of operation command behavior at start (slot 2)	00 (Operation command disabled)/ 01 (Operation command enabled)	00		*1)
<a href="#">oA-30</a>	Operation selection when option error occurs (slot 3)	00 (Error)/01 (Continue operation)	00		*1)
<a href="#">oA-31</a>	Communication monitoring timer setting (slot 3)	0.00~100.00 (s)	1.00		*1)
oA-32	Operation setting at the time of communication error (slot 3)	00 (Error)/ 01 (Trip after deceleration stop)/ 02 (Ignore)/03 (Free run)/ 04 (Deceleration stop)	01		*1)
oA-33	Selection of operation command behavior at start (slot 3)	00 (Operation command disabled)/ 01 (Operation command enabled)	00		*1)

\*1) For details, refer to the instruction manual provided together with the each optional cassette.

Code	Name	Data range	Initial value	Note	Page
ob-01	Encoder constant set-up (option)	32~65535 (pls)	1024		*1)
ob-02	Encoder phase sequence selection (option)	00 (Phase-A is leading)/ 01 (Phase-B is leading)	00		*1)
ob-03	Motor gear ratio's numerator (option)	1~10000	1		*1)
ob-04	Motor gear ratio's denominator (option)	1~10000	1		*1)
ob-10	Pulse string input SA/SB (option) detection target selection	00 (Command)/ 01 (Pulse string position command)	00		*1)
ob-11	Pulse string input (option) mode selection	00 (90° phase difference)/ 01 (forward/reverse rotation command and rotation direction)/ 02 (forward/reverse rotation pulse string)	01		*1)
<a href="#">ob-12</a>	Pulse string input (option) scale	0.05~200.0 (kHz)	25.00		*1)
<a href="#">ob-13</a>	Pulse string input (option) filter time constant	0.01~2.00 (s)	0.10		*1)
<a href="#">ob-14</a>	Pulse string input (option) bias size	-100.0~100.0 (%)	0.0		*1)
<a href="#">ob-15</a>	Pulse string input (option) upper detection limit	0.0~100.0 (%)	100.0		*1)
<a href="#">ob-16</a>	Pulse string input (option) lower detection limit	0.0~100.0 (%)	0.0		*1)

\*1) For details, refer to the instruction manual provided together with the each optional cassette.

Code	Name	Data range	Initial value	Note	Page
oC-01	Safety-option input indication selection	00 (With warning indication)/ 01 (Without warning indication)	00		*1)
oC-10	SS1-A deceleration time	0.00~3600.00 (s)	30.00		*1)
oC-12	SLS-A deceleration time	0.00~3600.00 (s)	30.00		*1)
<u>oC-14</u>	SLS-A speed upper limit: normal rotation	0.00~590.00 (Hz)	0.00		*1)
<u>oC-15</u>	SLS-A speed upper limit: reverse rotation	0.00~590.00 (Hz)	0.00		*1)
oC-16	SDI-A deceleration time	0.00~3600.00 (s)	30.00		*1)
oC-18	SDI-A restriction direction	00 (Restriction)/01 (Reverse rotation)	00		*1)
oC-20	SS1-B deceleration time	0.00~3600.00 (s)	30.00		*1)
oC-22	SLS-B deceleration time	0.00~3600.00 (s)	30.00		*1)
<u>oC-24</u>	SLS-B speed upper limit: normal rotation	0.00~590.00 (Hz)	0.00		*1)
<u>oC-25</u>	SLS-B speed upper limit: reverse rotation	0.00~590.00 (Hz)	0.00		*1)
oC-26	SDI-B deceleration time	0.00~3600.00 (s)	30.00		*1)
oC-28	SDI-B restriction direction	00 (Restriction)/01 (Reverse rotation)	00		*1)

\*1) For details, refer to the instruction manual provided together with the each optional cassette.

Code	Name	Data range	Initial value	Note	Page
<a href="#">oE-01</a>	[Ai4] terminal input filter time constant	1~500 (ms)	16		*1)
<a href="#">oE-03</a>	[Ai4] terminal start amount	0.00~100.00 (%)	0.00		*1)
<a href="#">oE-04</a>	[Ai4] terminal end amount	0.00~100.00 (%)	100.00		*1)
<a href="#">oE-05</a>	[Ai4] terminal start ratio	0.0~[oE-06] (%)	0.0		*1)
<a href="#">oE-06</a>	[Ai4] terminal end ratio	[oE-05]~100.0 (%)	100.0		*1)
<a href="#">oE-07</a>	[Ai4] terminal start selection	00 (Start amount [oE-03])/01 (0%)	01		*1)
<a href="#">oE-11</a>	[Ai5] terminal input filter time constant	1~500 (ms)	16		*1)
<a href="#">oE-13</a>	[Ai5] terminal start amount	0.00~100.00 (%)	0.00		*1)
<a href="#">oE-14</a>	[Ai5] terminal end amount	0.00~100.00 (%)	100.00		*1)
<a href="#">oE-15</a>	[Ai5] terminal start ratio	0.0~[oE-16] (%)	0.0		*1)
<a href="#">oE-16</a>	[Ai5] terminal end ratio	[oE-15]~100.0 (%)	100.0		*1)
<a href="#">oE-17</a>	[Ai5] terminal start selection	00 (Start amount [oE-13])/01 (0%)	01		*1)
<a href="#">oE-21</a>	[Ai6] terminal input filter time constant	1~500 (ms)	16		*1)
<a href="#">oE-23</a>	[Ai6] terminal start amount	-100.00~100.00 (%)	-100.00		*1)
<a href="#">oE-24</a>	[Ai6] terminal end amount	-100.00~100.00 (%)	100.00		*1)
<a href="#">oE-25</a>	[Ai6] terminal start ratio	-100.0~[oE-26] (%)	-100.0		*1)
<a href="#">oE-26</a>	[Ai6] terminal end ratio	[oE-25]~100.0 (%)	100.0		*1)

\*1) For details, refer to the instruction manual provided together with the each optional cassette.

Code	Name	Data range	Initial value	Note	Page
<a href="#">oE-28</a>	[Ai4] voltage/current bias adjustment	-100.00~100.00 (%)	0.00		*1)
<a href="#">oE-29</a>	[Ai4] voltage adjustment gain	0.00~200.00 (%)	100.00		*1)
<a href="#">oE-30</a>	[Ai5] voltage/current bias adjustment	-100.00~100.00 (%)	0.00		*1)
<a href="#">oE-31</a>	[Ai5] voltage adjustment gain	0.00~200.00 (%)	100.00		*1)
<a href="#">oE-32</a>	[Ai6] voltage bias adjustment	-100.00~100.00 (%)	0.00		*1)
<a href="#">oE-33</a>	[Ai6] voltage adjustment gain	0.00~200.00 (%)	100.00		*1)

\*1) For details, refer to the instruction manual provided together with the each optional cassette.

Code	Name	Data range	Initial value	Note	Page
<a href="#">oE-35</a>	Window comparator [Ai4] upper limit level	0~100 (%)	100		*1)
<a href="#">oE-36</a>	Window comparator [Ai4] lower limit level	0~100 (%)	0		*1)
<a href="#">oE-37</a>	Window comparator [Ai4] hysteresis range	0~10 (%)	0		*1)
<a href="#">oE-38</a>	Window comparator [Ai5] upper limit level	0~100 (%)	100		*1)
<a href="#">oE-39</a>	Window comparator [Ai5] lower limit level	0~100 (%)	0		*1)
<a href="#">oE-40</a>	Window comparator [Ai5] hysteresis range	0~10 (%)	0		*1)
<a href="#">oE-41</a>	Window comparator [Ai6] lower limit level	-100~100 (%)	100		*1)
<a href="#">oE-42</a>	Window comparator [Ai6] lower limit level	-100~100 (%)	-100		*1)
<a href="#">oE-43</a>	Window comparator [Ai6] hysteresis range	0~10 (%)	0		*1)
<a href="#">oE-44</a>	[Ai4] operation level at disconnection	-100~100 (%)	0		*1)
<a href="#">oE-45</a>	[Ai4] operation level selection at disconnection	00 (Disabled)/ 01 (Enabled: out of range)/ 02 (Enabled: within the range)	00		*1)
<a href="#">oE-46</a>	[Ai5] operation level at disconnection	0~100 (%)	0		*1)
<a href="#">oE-47</a>	[Ai5] operation level selection at disconnection	00 (Disabled)/ 01 (Enabled: out of range)/ 02 (Enabled: within the range)	00		*1)
<a href="#">oE-48</a>	[Ai6] operation level at disconnection	0~100 (%)	0		*1)
<a href="#">oE-49</a>	[Ai6] operation level selection at disconnection	00 (Disabled)/ 01 (Enabled: out of range)/ 02 (Enabled: within the range)	00		*1)

\*1) For details, refer to the instruction manual provided together with the each optional cassette.

Code	Name	Data range	Initial value	Note	Page
<a href="#">oE-50</a>	[Ao3] terminal output selection	See the List of output monitor functions	dA-01		*1)
<a href="#">oE-51</a>	[Ao4] terminal output selection	See the List of output monitor functions	dA-01		*1)
<a href="#">oE-52</a>	[Ao5] terminal output selection	See the List of output monitor functions	dA-01		*1)
<a href="#">oE-56</a>	[Ao3] output filter time constant	1~500 (ms)	100		*1)
<a href="#">oE-57</a>	[Ao3] output data type selection	00 (absolute value)/01 (with sign)	00		*1)
<a href="#">oE-58</a>	[Ao3] bias adjustment (voltage/current)	-100.0~100.0 (%)	0.0		*1)
<a href="#">oE-59</a>	[Ao3] gain adjustment (voltage/current)	-1000.0~1000.0 (%)	100.0		*1)
<a href="#">oE-60</a>	[Ao3] output level in the adjustment mode	-100.0~100.0 (%)	100.0		*1)
<a href="#">oE-61</a>	[Ao4] output filter time constant	1~500 (ms)	100		*1)
<a href="#">oE-62</a>	[Ao4] output data type selection	00 (absolute value)/01 (with sign)	00		*1)
<a href="#">oE-63</a>	[Ao4] bias adjustment (voltage/current)	-100.0~100.0 (%)	0.0		*1)
<a href="#">oE-64</a>	[Ao4] gain adjustment (voltage/current)	-1000.0~1000.0 (%)	100.0		*1)
<a href="#">oE-65</a>	[Ao4] output level in the adjustment mode	-100.0~100.0 (%)	100.0		*1)
<a href="#">oE-66</a>	[Ao5] output filter time constant	1~500(ms)	100		*1)
<a href="#">oE-67</a>	[Ao5] output data type selection	00 (absolute value)/01 (with sign)	00		*1)
<a href="#">oE-68</a>	[Ao5] bias adjustment (voltage)	-100.0~100.0 (%)	0.0		*1)
<a href="#">oE-69</a>	[Ao5] gain adjustment (voltage)	-1000.0~1000.0 (%)	100.0		*1)
<a href="#">oE-70</a>	[Ao5] output level in the adjustment mode	-100.0~100.0 (%)	100.0		*1)

\*1) For details, refer to the instruction manual provided together with the each optional cassette.

Code	Name	Data range	Initial value	Note	Page
oH-01	IP address selection (P1-EN)	00 (Gr.1)/01 (Gr.2)	00		*1)
oH-02	Transmission speed (port 1) (P1-EN)	00 (Auto negotiation)/ 01 (100M: full duplex)/ 02 (100M: half duplex)/	00		*1)
oH-03	Transmission speed (port 2) (P1-EN)	03 (10M: full duplex)/ 04 (10M: half duplex)	00		*1)
oH-04	Ethernet communication timeout (P1-EN)	1~65535 (×10ms)	3000		*1)
oH-05	Modbus TCP port number (IPv4)	502, 1024~65535	502		*1)
oH-06	Modbus TCP port number (IPv6)	502, 1024~65535	502		*1)
oH-20	Profibus Nobe address	0~125	0		*1)
oH-21	Profibus Clear Mode selection	00 (Clear)/ 01 (Value retained the last time)	00		*1)
oH-22	Profibus Map selection	00 (PPO)/01 (Comvertional)/ 02 (FlexibleMode)	00		*1)
oH-23	Selection of setting from the Profibus master	00 (Allowed)/01 (Not allowed)	00		*1)
oH-24	Selection of setpoint telegram/Actual value telegram Gr	00 (Gr.A)/01 (Gr.B)/02 (Gr.C)	00		*1)

\*1) For details, refer to the instruction manual provided together with the each optional cassette.

Code	Name	Data range	Initial value	Note	Page
oH-30	IP address selection (P1-PN)	00 (Gr.1)/01 (Gr.2)	00		*1)
oH-31	Transmission speed (port 1) (P1-PN)	00 (Auto negotiation)/ 01 (100M: full duplex)/ 02 (100M: half duplex)/	00		*1)
oH-32	Transmission speed (port 2) (P1-PN)	03 (10M: full duplex)/ 04 (10M: half duplex)	00		*1)
oH-33	Ethernet communication timeout (P1-PN)	1~65535 (x10ms)	3000		*1)
oH-34	Selection of setpoint telegram/Actual value telegram Gr	00 (Gr.A)/01 (Gr.B)/02 (Gr.C)	502		*1)

\*1) For details, refer to the instruction manual provided together with the each optional cassette.

Code	Name	Data range	Initial value	Note	Page
oJ-01	Gr.A flexible command registration writing register 1	0000~FFFF	0000		*1)
oJ-02	Gr.A flexible command registration writing register 2	0000~FFFF	0000		*1)
oJ-03	Gr.A flexible command registration writing register 3	0000~FFFF	0000		*1)
oJ-04	Gr.A flexible command registration writing register 4	0000~FFFF	0000		*1)
oJ-05	Gr.A flexible command registration writing register 5	0000~FFFF	0000		*1)
oJ-06	Gr.A flexible command registration writing register 6	0000~FFFF	0000		*1)
oJ-07	Gr.A flexible command registration writing register 7	0000~FFFF	0000		*1)
oJ-08	Gr.A flexible command registration writing register 8	0000~FFFF	0000		*1)
oJ-09	Gr.A flexible command registration writing register 9	0000~FFFF	0000		*1)
oJ-10	Gr.A flexible command registration writing register 10	0000~FFFF	0000		*1)
oJ-11	Gr.A flexible command registration reading register 1	0000~FFFF	0000		*1)
oJ-12	Gr.A flexible command registration reading register 2	0000~FFFF	0000		*1)
oJ-13	Gr.A flexible command registration reading register 3	0000~FFFF	0000		*1)
oJ-14	Gr.A flexible command registration reading register 4	0000~FFFF	0000		*1)
oJ-15	Gr.A flexible command registration reading register 5	0000~FFFF	0000		*1)
oJ-16	Gr.A flexible command registration reading register 6	0000~FFFF	0000		*1)
oJ-17	Gr.A flexible command registration reading register 7	0000~FFFF	0000		*1)
oJ-18	Gr.A flexible command registration reading register 8	0000~FFFF	0000		*1)
oJ-19	Gr.A flexible command registration reading register 9	0000~FFFF	0000		*1)
oJ-20	Gr.A flexible command registration reading register 10	0000~FFFF	0000		*1)
oJ-21	Gr.B flexible command registration writing register 1	0000~FFFF	0000		*1)
oJ-22	Gr.B flexible command registration writing register 2	0000~FFFF	0000		*1)
oJ-23	Gr.B flexible command registration writing register 3	0000~FFFF	0000		*1)
oJ-24	Gr.B flexible command registration writing register 4	0000~FFFF	0000		*1)
oJ-25	Gr.B flexible command registration writing register 5	0000~FFFF	0000		*1)
oJ-26	Gr.B flexible command registration writing register 6	0000~FFFF	0000		*1)
oJ-27	Gr.B flexible command registration writing register 7	0000~FFFF	0000		*1)
oJ-28	Gr.B flexible command registration writing register 8	0000~FFFF	0000		*1)
oJ-29	Gr.B flexible command registration writing register 9	0000~FFFF	0000		*1)
oJ-30	Gr.B flexible command registration writing register 10	0000~FFFF	0000		*1)
oJ-31	Gr.B flexible command registration reading register 1	0000~FFFF	0000		*1)
oJ-32	Gr.B flexible command registration reading register 2	0000~FFFF	0000		*1)
oJ-33	Gr.B flexible command registration reading register 3	0000~FFFF	0000		*1)
oJ-34	Gr.B flexible command registration reading register 4	0000~FFFF	0000		*1)
oJ-35	Gr.B flexible command registration reading register 5	0000~FFFF	0000		*1)
oJ-36	Gr.B flexible command registration reading register 6	0000~FFFF	0000		*1)

\*1) For details, refer to the instruction manual provided together with the each optional cassette.



Code	Name	Data range	Initial value	Note	Page
oJ-37	Gr.B flexible command registration reading register 7	0000~FFFF	0000		*1)
oJ-38	Gr.B flexible command registration reading register 8	0000~FFFF	0000		*1)
oJ-39	Gr.B flexible command registration reading register 9	0000~FFFF	0000		*1)
oJ-40	Gr.B flexible command registration reading register 10	0000~FFFF	0000		*1)
oJ-41	Gr.C flexible command registration writing register 1	0000~FFFF	0000		*1)
oJ-42	Gr.C flexible command registration writing register 2	0000~FFFF	0000		*1)
oJ-43	Gr.C flexible command registration writing register 3	0000~FFFF	0000		*1)
oJ-44	Gr.C flexible command registration writing register 4	0000~FFFF	0000		*1)
oJ-45	Gr.C flexible command registration writing register 5	0000~FFFF	0000		*1)
oJ-46	Gr.C flexible command registration writing register 6	0000~FFFF	0000		*1)
oJ-47	Gr.C flexible command registration writing register 7	0000~FFFF	0000		*1)
oJ-48	Gr.C flexible command registration writing register 8	0000~FFFF	0000		*1)
oJ-49	Gr.C flexible command registration writing register 9	0000~FFFF	0000		*1)
oJ-50	Gr.C flexible command registration writing register 10	0000~FFFF	0000		*1)
oJ-51	Gr.C flexible command registration reading register 1	0000~FFFF	0000		*1)
oJ-52	Gr.C flexible command registration reading register 2	0000~FFFF	0000		*1)
oJ-53	Gr.C flexible command registration reading register 3	0000~FFFF	0000		*1)
oJ-54	Gr.C flexible command registration reading register 4	0000~FFFF	0000		*1)
oJ-55	Gr.C flexible command registration reading register 5	0000~FFFF	0000		*1)
oJ-56	Gr.C flexible command registration reading register 6	0000~FFFF	0000		*1)
oJ-57	Gr.C flexible command registration reading register 7	0000~FFFF	0000		*1)
oJ-58	Gr.C flexible command registration reading register 8	0000~FFFF	0000		*1)
oJ-59	Gr.C flexible command registration reading register 9	0000~FFFF	0000		*1)
oJ-60	Gr.C flexible command registration reading register 10	0000~FFFF	0000		*1)

\*1) For details, refer to the instruction manual provided together with the each optional cassette.

Code	Name	Data range	Initial value	Note	Page
oL-01	Gr.1 IPv4 IP address (1)	0~255	192		*1)
oL-02	Gr.1 IPv4 IP address (2)	0~255	168		*1)
oL-03	Gr.1 IPv4 IP address (3)	0~255	0		*1)
oL-04	Gr.1 IPv4 IP address (4)	0~255	2		*1)
oL-05	Gr.1 IPv4 subnet mask (1)	0~255	255		*1)
oL-06	Gr.1 IPv4 subnet mask (2)	0~255	255		*1)
oL-07	Gr.1 IPv4 subnet mask (3)	0~255	255		*1)
oL-08	Gr.1 IPv4 subnet mask (4)	0~255	0		*1)
oL-09	Gr.1 IPv4 default gateway (1)	0~255	192		*1)
oL-10	Gr.1 IPv4 default gateway (2)	0~255	168		*1)
oL-11	Gr.1 IPv4 default gateway (3)	0~255	0		*1)
oL-12	Gr.1 IPv4 default gateway (4)	0~255	1		*1)
oL-20	Gr.1 IPv6 IP address (1)	0000~FFFF	0000		*1)
oL-21	Gr.1 IPv6 IP address (2)	0000~FFFF	0000		*1)
oL-22	Gr.1 IPv6 IP address (3)	0000~FFFF	0000		*1)
oL-23	Gr.1 IPv6 IP address (4)	0000~FFFF	0000		*1)
oL-24	Gr.1 IPv6 IP address (5)	0000~FFFF	0000		*1)
oL-25	Gr.1 IPv6 IP address (6)	0000~FFFF	0000		*1)
oL-26	Gr.1 IPv6 IP address (7)	0000~FFFF	0000		*1)
oL-27	Gr.1 IPv6 IP address (8)	0000~FFFF	0000		*1)
oL-28	Gr.1 IPv6 subnet prefix	0~127	64		*1)
oL-29	Gr.1 IPv6 default gateway (1)	0000~FFFF	0000		*1)
oL-30	Gr.1 IPv6 default gateway (2)	0000~FFFF	0000		*1)
oL-31	Gr.1 IPv6 default gateway (3)	0000~FFFF	0000		*1)
oL-32	Gr.1 IPv6 default gateway (4)	0000~FFFF	0000		*1)
oL-33	Gr.1 IPv6 default gateway (5)	0000~FFFF	0000		*1)
oL-34	Gr.1 IPv6 default gateway (6)	0000~FFFF	0000		*1)
oL-35	Gr.1 IPv6 default gateway (7)	0000~FFFF	0000		*1)
oL-36	Gr.1 IPv6 default gateway (8)	0000~FFFF	0000		*1)

\*1) For details, refer to the instruction manual provided together with the each optional cassette.

Code	Name	Data range	Initial value	Note	Page
oL-40	Gr.2 IPv4 IP address (1)	0~255	192		*1)
oL-41	Gr.2 IPv4 IP address (2)	0~255	168		*1)
oL-42	Gr.2 IPv4 IP address (3)	0~255	0		*1)
oL-43	Gr.2 IPv4 IP address (4)	0~255	2		*1)
oL-44	Gr.2 IPv4 subnet mask (1)	0~255	255		*1)
oL-45	Gr.2 IPv4 subnet mask (2)	0~255	255		*1)
oL-46	Gr.2 IPv4 subnet mask (3)	0~255	255		*1)
oL-47	Gr.2 IPv4 subnet mask (4)	0~255	0		*1)
oL-48	Gr.2 IPv4 default gateway (1)	0~255	192		*1)
oL-49	Gr.2 IPv4 default gateway (2)	0~255	168		*1)
oL-50	Gr.2 IPv4 default gateway (3)	0~255	0		*1)
oL-51	Gr.2 IPv4 default gateway (4)	0~255	1		*1)
oL-60	Gr.2 IPv6 IP address (1)	0000~FFFF	0000		*1)
oL-61	Gr.2 IPv6 IP address (2)	0000~FFFF	0000		*1)
oL-62	Gr.2 IPv6 IP address (3)	0000~FFFF	0000		*1)
oL-63	Gr.2 IPv6 IP address (4)	0000~FFFF	0000		*1)
oL-64	Gr.2 IPv6 IP address (5)	0000~FFFF	0000		*1)
oL-65	Gr.2 IPv6 IP address (6)	0000~FFFF	0000		*1)
oL-66	Gr.2 IPv6 IP address (7)	0000~FFFF	0000		*1)
oL-67	Gr.2 IPv6 IP address (8)	0000~FFFF	0000		*1)
oL-68	Gr.2 IPv6 subnet prefix	0~127	64		*1)
oL-69	Gr.2 IPv6 default gateway (1)	0000~FFFF	0000		*1)
oL-70	Gr.2 IPv6 default gateway (2)	0000~FFFF	0000		*1)
oL-71	Gr.2 IPv6 default gateway (3)	0000~FFFF	0000		*1)
oL-72	Gr.2 IPv6 default gateway (4)	0000~FFFF	0000		*1)
oL-73	Gr.2 IPv6 default gateway (5)	0000~FFFF	0000		*1)
oL-74	Gr.2 IPv6 default gateway (6)	0000~FFFF	0000		*1)
oL-75	Gr.2 IPv6 default gateway (7)	0000~FFFF	0000		*1)
oL-76	Gr.2 IPv6 default gateway (8)	0000~FFFF	0000		*1)

\*1) For details, refer to the instruction manual provided together with the each optional cassette.

## ■ Parameter mode (code P)

Code	Name	Data range	Initial value	Note	Page
PA-01	Forced operation mode selection	00 (Disabled)/01 (Enabled)	00		12-17-13
PA-02	Forced operation frequency setting	0.00~590.00 (Hz)	0.00		
PA-03	Forced operation rotation direction command	00 (Normal rotation)/01 (Reverse rotation)	00		
PA-04	Commercial power supply bypass function selection	00 (Disabled)/01 (Enabled)	00		12-17-15
PA-05	Bypass function delay time	0.0~1000.0 (s)	5.0		

Code	Name	Data range	Initial value	Note	Page
PA-20	Simulation mode selection	00 (Disabled)/01 (Enabled)	00		10-9
PA-21	Selection of error code for alarm test	000~255	000		
<a href="#">PA-22</a>	Output current monitor optional output selection	00 (Disabled)/01 (Enabled: parameter setting [PA-23]) 02 (Enabled: set from [Ai1])/03 (Enabled: set from [Ai2])/ 04 (Enabled: set from [Ai3])/05 (Enabled: set from [Ai4])/ 06 (Enabled: set from [Ai5])/07 (Enabled: set from [Ai6])	01		
<a href="#">PA-23</a>	Output current monitor optional setting value	0.0 to 3.0 × Inverter rated current (A)	0.0		
<a href="#">PA-24</a>	P-N voltage monitor optional output selection	00 (Disabled)/01 (Enabled: parameter setting [PA-25]) 02 (Enabled: set from [Ai1])/03 (Enabled: set from [Ai2])/ 04 (Enabled: set from [Ai3])/05 (Enabled: set from [Ai4])/ 06 (Enabled: set from [Ai5])/07 (Enabled: set from [Ai6])	01		
<a href="#">PA-25</a>	P-N voltage monitor optional setting value	200V class: 0.0 to 450.0 (Vdc) 400V class: 0.0 to 900.0 (Vdc)	200 V class: 270.0 400V class: 540.0		
<a href="#">PA-26</a>	Output voltage monitor optional output selection	00 (Disabled)/01 (Enabled: parameter setting [PA-27]) 02 (Enabled: set from [Ai1])/03 (Enabled: set from [Ai2])/ 04 (Enabled: set from [Ai3])/05 (Enabled: set from [Ai4])/ 06 (Enabled: set from [Ai5])/07 (Enabled: set from [Ai6])	01		
<a href="#">PA-27</a>	Output voltage monitor optional setting value	200V class: 0.0-300.0 (V) 400V class: 0.0-600.0 (V)	0.0		
<a href="#">PA-28</a>	Output torque monitor optional output selection	00 (Disabled)/01 (Enabled: parameter setting [PA-29]) 02 (Enabled: set from [Ai1])/03 (Enabled: set from [Ai2])/ 04 (Enabled: set from [Ai3])/05 (Enabled: set from [Ai4])/ 06 (Enabled: set from [Ai5])/07 (Enabled: set from [Ai6])	01		
<a href="#">PA-29</a>	Output torque monitor optional setting value	-500.0~+500.0 (%)	0.0		
<a href="#">PA-30</a>	Frequency adjustment optional output selection	00 (Disabled)/01 (Enabled: parameter setting [PA-31]) 02 (Enabled: set from [Ai1])/03 (Enabled: set from [Ai2])/ 04 (Enabled: set from [Ai3])/05 (Enabled: set from [Ai4])/ 06 (Enabled: set from [Ai5])/07 (Enabled: set from [Ai6])	01		
<a href="#">PA-31</a>	Frequency matching optional setting value	0.0~590.00 (Hz)	0.00		

## ■ Parameter mode (code U)

Code	Name	Data range	Initial value	Note	Page
UA-01	Password input for display selection	0000~FFFF	0000		9-34
UA-02	Soft-lock password input	0000~FFFF	0000		9-34
UA-10	Display selection	00 (Full display)/01 (By function)/ 02 (User setting)/03 (Conveyor display)/ 04 (Only monitor display)	00		9-34
<a href="#">UA-12</a>	Clearing of integrated input power	00 (Disabled)/01 (Clear)	00		13-14
<a href="#">UA-13</a>	Integrated input power display gain	1~1000	1		13-14
<a href="#">UA-14</a>	Clearing of integrated output power	00 (Disabled)/01 (Clear)	00		13-15
<a href="#">UA-15</a>	Integrated output power display gain	1~1000	1		13-15
<a href="#">UA-16</a>	Soft-lock selection	00 ([SFT] terminal)/01 (Always enabled)	00		9-24
<a href="#">UA-17</a>	Soft-lock target selection	00 (All data cannot be changed)/ 01 (Data other than set frequency cannot be changed)	00		9-24
UA-18	Data R/W selection	00 (R/W enabled)/01 (R/W disabled)	00		9-39
UA-19	Battery level warning selection	00 (Disabled)/01 (Warning)/02 (Error)	00		9-38
UA-20	Operation at disconnection of operator keypad	00 (Error)/01 (Error after deceleration stop)/ 02 (Ignore)/03 (Free run)/04 (Deceleration stop)	02		9-37
UA-21	Selection of second setting parameter display	00 (Not display)/01 (Display)	01		9-25
UA-22	Selection of option parameter display	00 (Not display)/01 (Display)	01		9-25
UA-30	Selection of user parameter automatic setting	00 (Disabled)/01 (Enabled)	00		9-33
<a href="#">UA-31</a>	User parameter 1 selection	no/***** (select a parameter)	no		9-33
<a href="#">UA-32</a>	User parameter 2 selection	no/***** (select a parameter)	no		9-33
<a href="#">UA-33</a>	User parameter 3 selection	no/***** (select a parameter)	no		9-33
<a href="#">UA-34</a>	User parameter 4 selection	no/***** (select a parameter)	no		9-33
<a href="#">UA-35</a>	User parameter 5 selection	no/***** (select a parameter)	no		9-33
<a href="#">UA-36</a>	User parameter 6 selection	no/***** (select a parameter)	no		9-33
<a href="#">UA-37</a>	User parameter 7 selection	no/***** (select a parameter)	no		9-33
<a href="#">UA-38</a>	User parameter 8 selection	no/***** (select a parameter)	no		9-33
<a href="#">UA-39</a>	User parameter 9 selection	no/***** (select a parameter)	no		9-33
<a href="#">UA-40</a>	User parameter 10 selection	no/***** (select a parameter)	no		9-33
<a href="#">UA-41</a>	User parameter 11 selection	no/***** (select a parameter)	no		9-33
<a href="#">UA-42</a>	User parameter 12 selection	no/***** (select a parameter)	no		9-33
<a href="#">UA-43</a>	User parameter 13 selection	no/***** (select a parameter)	no		9-33
<a href="#">UA-44</a>	User parameter 14 selection	no/***** (select a parameter)	no		9-33
<a href="#">UA-45</a>	User parameter 15 selection	no/***** (select a parameter)	no		9-33
<a href="#">UA-46</a>	User parameter 16 selection	no/***** (select a parameter)	no		9-33
<a href="#">UA-47</a>	User parameter 17 selection	no/***** (select a parameter)	no		9-33
<a href="#">UA-48</a>	User parameter 18 selection	no/***** (select a parameter)	no		9-33
<a href="#">UA-49</a>	User parameter 19 selection	no/***** (select a parameter)	no		9-33
<a href="#">UA-50</a>	User parameter 20 selection	no/***** (select a parameter)	no		9-33
<a href="#">UA-51</a>	User parameter 21 selection	no/***** (select a parameter)	no		9-33
<a href="#">UA-52</a>	User parameter 22 selection	no/***** (select a parameter)	no		9-33
<a href="#">UA-53</a>	User parameter 23 selection	no/***** (select a parameter)	no		9-33
<a href="#">UA-54</a>	User parameter 24 selection	no/***** (select a parameter)	no		9-33
<a href="#">UA-55</a>	User parameter 25 selection	no/***** (select a parameter)	no		9-33
<a href="#">UA-56</a>	User parameter 26 selection	no/***** (select a parameter)	no		9-33
<a href="#">UA-57</a>	User parameter 27 selection	no/***** (select a parameter)	no		9-33
<a href="#">UA-58</a>	User parameter 28 selection	no/***** (select a parameter)	no		9-33
<a href="#">UA-59</a>	User parameter 29 selection	no/***** (select a parameter)	no		9-33
<a href="#">UA-60</a>	User parameter 30 selection	no/***** (select a parameter)	no		9-33
<a href="#">UA-61</a>	User parameter 31 selection	no/***** (select a parameter)	no		9-33
<a href="#">UA-62</a>	User parameter 32 selection	no/***** (select a parameter)	no		9-33

Code	Name	Data range	Initial value	Note	Page
UA-90	Operator keypad display off standby time (QOP)	0~60	0		-
UA-91	Initial screen selection (QOP)	no/***** (select a monitor parameter)	dA-01		-
UA-92	Initial screen automatic transition function (QOP)	00 (Disabled)/01 (Enabled)	00		-
UA-93	Selection of data change during monitoring (QOP)	00 (Disabled)/01 (Enabled)	00		-
UA-94	Selection of multi-speed command change during monitoring (QOP)	00 (Disabled)/01 (Enabled)	00		-

Code	Name	Data range	Initial value	Note	Page
Ub-01	Selection of factory default initialization	00 (Disabled)/01 (Trip history)/ 02 (Parameter initialization)/ 03 (Trip history + parameters)/ 04 (Trip history + parameters + EzSQ)/ 05 (Other than terminal function)/ 06 (Other than communication function)/ 07 (Other than terminal&communication functions)/ 08 (Only EzSQ)	00		
Ub-02	Selection of initial values	00 (Mode 0)/01 (Mode 1)/02 (Mode 2)/03 (Mode 3)	00 (*FF)/ 01 (*FEF)/ 02 (*FUF)/ 03 (*FCF)/		-
Ub-03	Duty type selection	00 (VLD)/01 (LD)/02 (ND)	02		
Ub-05	Initialization start selection	00 (Disabled)/01 (Start initialization)	00		

Code	Name	Data range	Initial value	Note	Page
<a href="#">UC-01</a>	Debug mode selection	(do not change)	00	-	-

Code	Name	Data range	Initial value	Note	Page
<a href="#">Ud-01</a>	Trace function selection	00 (Disabled)/01 (Enabled)	00		16-8
<a href="#">Ud-02</a>	Trace start	00 (Stop)/01 (Start)	00		16-8
<a href="#">Ud-03</a>	Selection of the number of trace data sets	0-8	1		16-8
<a href="#">Ud-04</a>	Selection of the number of trace signals	0-8	1		16-8
<a href="#">Ud-10</a>	Selection of trace data 0	See Appendix 1-40 <List of output monitor functions>.	dA-01		16-8
<a href="#">Ud-11</a>	Selection of trace data 1		dA-01		16-8
<a href="#">Ud-12</a>	Selection of trace data 2		dA-01		16-8
<a href="#">Ud-13</a>	Selection of trace data 3		dA-01		16-8
<a href="#">Ud-14</a>	Selection of trace data 4		dA-01		16-8
<a href="#">Ud-15</a>	Selection of trace data 5		dA-01		16-8
<a href="#">Ud-16</a>	Selection of trace data 6		dA-01		16-8
<a href="#">Ud-17</a>	Selection of trace data 7		dA-01		16-8
<a href="#">Ud-20</a>	Trace signal 0 I/O selection	00 (Input: [Ud-21])/01 (Output: [Ud-22])	00		16-8
<a href="#">Ud-21</a>	Trace signal 0 input terminal selection	*1)	001		16-8
<a href="#">Ud-22</a>	Trace signal 0 output terminal selection	*2)	001		16-8
<a href="#">Ud-23</a>	Trace signal 1 I/O selection	00 (Input: [Ud-24])/01 (Output: [Ud-25])	00		16-8
<a href="#">Ud-24</a>	Trace signal 1 input terminal selection	*1)	001		16-8
<a href="#">Ud-25</a>	Trace signal 1 output terminal selection	*2)	001		16-8
<a href="#">Ud-26</a>	Trace signal 2 I/O selection	00 (Input: [Ud-27])/01 (Output: [Ud-28])	00		16-8
<a href="#">Ud-27</a>	Trace signal 2 input terminal selection	*1)	001		16-8
<a href="#">Ud-28</a>	Trace signal 2 output terminal selection	*2)	001		16-8
<a href="#">Ud-29</a>	Trace signal 3 I/O selection	00 (Input: [Ud-30])/01 (Output: [Ud-31])	00		16-8
<a href="#">Ud-30</a>	Trace signal 3 input terminal selection	*1)	001		16-8
<a href="#">Ud-31</a>	Trace signal 3 output terminal selection	*2)	001		16-8
<a href="#">Ud-32</a>	Trace signal 4 I/O selection	00 (Input: [Ud-33])/01 (Output: [Ud-34])	00		16-8
<a href="#">Ud-33</a>	Trace signal 4 input terminal selection	*1)	001		16-8
<a href="#">Ud-34</a>	Trace signal 4 output terminal selection	*2)	001		16-8
<a href="#">Ud-35</a>	Trace signal 5 I/O selection	00 (Input: [Ud-36])/01 (Output: [Ud-37])	00		16-8
<a href="#">Ud-36</a>	Trace signal 5 input terminal selection	*1)	001		16-8
<a href="#">Ud-37</a>	Trace signal 5 output terminal selection	*2)	001		16-8
<a href="#">Ud-38</a>	Trace signal 6 I/O selection	00 (Input: [Ud-39])/01 (Output: [Ud-40])	00		16-8
<a href="#">Ud-39</a>	Trace signal 6 input terminal selection	*1)	001		16-8
<a href="#">Ud-40</a>	Trace signal 6 output terminal selection	*2)	001		16-8
<a href="#">Ud-41</a>	Trace signal 7 I/O selection	00 (Input: [Ud-42])/01 (Output: [Ud-43])	00		16-8
<a href="#">Ud-42</a>	Trace signal 7 input terminal selection	*1)	001		16-8
<a href="#">Ud-43</a>	Trace signal 7 output terminal selection	*2)	001		16-8

\*1) See Appendix 1-23<List of input terminal functions>.

\*2) See Appendix 1-37<List of output terminal functions>.

Code	Name	Data range	Initial value	Note	Page
<a href="#">Ud-50</a>	Selection of trace trigger 1	00 (Trip)/01 (Trace data 0)/02 (Trace data 1)/ 03 (Trace data 2)/04 (Trace data 3)/ 05 (Trace data 4)/06 (Trace data 5)/ 07 (Trace data 6)/08 (Trace data 7)/ 09 (Trace signal 0)/10 (Trace signal 1)/ 11 (Trace signal 2)/12 (Trace signal 3)/ 13 (Trace signal 4)/14 (Trace signal 5)/ 15 (Trace signal 6)/16 (Trace signal 7)	00		16-8
<a href="#">Ud-51</a>	Selection of trigger 1 operation at trace data trigger	00 (Operate when it is above the trigger level)/ 01 (Operate when it is below the trigger level)	00		16-8
<a href="#">Ud-52</a>	Trigger 1 level at trace data trigger	0~100 (%)	0		16-8
<a href="#">Ud-53</a>	Selection of trigger 1 operation at trace signal trigger	00 (Operate when the signal is ON)/ 01 (Operate when the signal is OFF)	00		16-8
<a href="#">Ud-54</a>	Selection of trace trigger 2	00 (Trip)/01 (Trace data 0)/02 (Trace data 1)/ 03 (Trace data 2)/04 (Trace data 3)/ 05 (Trace data 4)/06 (Trace data 5)/ 07 (Trace data 6)/08 (Trace data 7)/ 09 (Trace signal 0)/10 (Trace signal 1)/ 11 (Trace signal 2)/12 (Trace signal 3)/ 13 (Trace signal 4)/14 (Trace signal 5)/ 15 (Trace signal 6)/16 (Trace signal 7)	00		16-8
<a href="#">Ud-55</a>	Selection of trigger 2 operation at trace data trigger	00 (Rising edge)/01 (Falling edge)	00		16-8
<a href="#">Ud-56</a>	Trigger 2 level at trace data trigger	0~100 (%)	0		16-8
<a href="#">Ud-57</a>	Selection of trigger 2 operation at trace signal trigger	00 (Operate when the signal is ON)/ 01 (Operate when the signal is OFF)	00		16-8
<a href="#">Ud-58</a>	Trigger condition selection	00 (When trigger 1 is satisfied)/ 01 (When trigger 2 is satisfied)/ 02 (When trigger 1 or 2 is satisfied)/ 03 (When trigger 1 and 2 are satisfied)	00		16-8
<a href="#">Ud-59</a>	Trigger point setting	0~100 (%)	0		16-8
<a href="#">Ud-60</a>	Sampling time setting	01 (0.2ms)/02 (0.5ms)/03 (1ms)/04 (2ms)/ 05 (5ms)/06 (10ms)/07 (50ms)/08 (100ms)/ 09 (500ms)/10 (1000ms)	03		16-8



Code	Name	Data range	Initial value	Note	Page
UE-01	EzSQ execution interval	00 (1ms)/01 (2ms)	00		16-6
<a href="#">UE-02</a>	EzSQ function selection	00 (Disabled)/01 ([PRG] terminal)/ 02 (Always)	00		16-6
<a href="#">UE-10</a>	EzSQ user parameter U (00)	0~65535	0		16-6
<a href="#">UE-11</a>	EzSQ user parameter U (01)	0~65535	0		16-6
<a href="#">UE-12</a>	EzSQ user parameter U (02)	0~65535	0		16-6
<a href="#">UE-13</a>	EzSQ user parameter U (03)	0~65535	0		16-6
<a href="#">UE-14</a>	EzSQ user parameter U (04)	0~65535	0		16-6
<a href="#">UE-15</a>	EzSQ user parameter U (05)	0~65535	0		16-6
<a href="#">UE-16</a>	EzSQ user parameter U (06)	0~65535	0		16-6
<a href="#">UE-17</a>	EzSQ user parameter U (07)	0~65535	0		16-6
<a href="#">UE-18</a>	EzSQ user parameter U (08)	0~65535	0		16-6
<a href="#">UE-19</a>	EzSQ user parameter U (09)	0~65535	0		16-6
<a href="#">UE-20</a>	EzSQ user parameter U (10)	0~65535	0		16-6
<a href="#">UE-21</a>	EzSQ user parameter U (11)	0~65535	0		16-6
<a href="#">UE-22</a>	EzSQ user parameter U (12)	0~65535	0		16-6
<a href="#">UE-23</a>	EzSQ user parameter U (13)	0~65535	0		16-6
<a href="#">UE-24</a>	EzSQ user parameter U (14)	0~65535	0		16-6
<a href="#">UE-25</a>	EzSQ user parameter U (15)	0~65535	0		16-6
<a href="#">UE-26</a>	EzSQ user parameter U (16)	0~65535	0		16-6
<a href="#">UE-27</a>	EzSQ user parameter U (17)	0~65535	0		16-6
<a href="#">UE-28</a>	EzSQ user parameter U (18)	0~65535	0		16-6
<a href="#">UE-29</a>	EzSQ user parameter U (19)	0~65535	0		16-6
<a href="#">UE-30</a>	EzSQ user parameter U (20)	0~65535	0		16-6
<a href="#">UE-31</a>	EzSQ user parameter U (21)	0~65535	0		16-6
<a href="#">UE-32</a>	EzSQ user parameter U (22)	0~65535	0		16-6
<a href="#">UE-33</a>	EzSQ user parameter U (23)	0~65535	0		16-6
<a href="#">UE-34</a>	EzSQ user parameter U (24)	0~65535	0		16-6
<a href="#">UE-35</a>	EzSQ user parameter U (25)	0~65535	0		16-6
<a href="#">UE-36</a>	EzSQ user parameter U (26)	0~65535	0		16-6
<a href="#">UE-37</a>	EzSQ user parameter U (27)	0~65535	0		16-6
<a href="#">UE-38</a>	EzSQ user parameter U (28)	0~65535	0		16-6
<a href="#">UE-39</a>	EzSQ user parameter U (29)	0~65535	0		16-6
<a href="#">UE-40</a>	EzSQ user parameter U (30)	0~65535	0		16-6

Code	Name	Data range	Initial value	Note	Page
<a href="#">UE-41</a>	EzSQ user parameter U (31)	0-65535	0		16-6
<a href="#">UE-42</a>	EzSQ user parameter U (32)	0-65535	0		16-6
<a href="#">UE-43</a>	EzSQ user parameter U (33)	0-65535	0		16-6
<a href="#">UE-44</a>	EzSQ user parameter U (34)	0-65535	0		16-6
<a href="#">UE-45</a>	EzSQ user parameter U (35)	0-65535	0		16-6
<a href="#">UE-46</a>	EzSQ user parameter U (36)	0-65535	0		16-6
<a href="#">UE-47</a>	EzSQ user parameter U (37)	0-65535	0		16-6
<a href="#">UE-48</a>	EzSQ user parameter U (38)	0-65535	0		16-6
<a href="#">UE-49</a>	EzSQ user parameter U (39)	0-65535	0		16-6
<a href="#">UE-50</a>	EzSQ user parameter U (40)	0-65535	0		16-6
<a href="#">UE-51</a>	EzSQ user parameter U (41)	0-65535	0		16-6
<a href="#">UE-52</a>	EzSQ user parameter U (42)	0-65535	0		16-6
<a href="#">UE-53</a>	EzSQ user parameter U (43)	0-65535	0		16-6
<a href="#">UE-54</a>	EzSQ user parameter U (44)	0-65535	0		16-6
<a href="#">UE-55</a>	EzSQ user parameter U (45)	0-65535	0		16-6
<a href="#">UE-56</a>	EzSQ user parameter U (46)	0-65535	0		16-6
<a href="#">UE-57</a>	EzSQ user parameter U (47)	0-65535	0		16-6
<a href="#">UE-58</a>	EzSQ user parameter U (48)	0-65535	0		16-6
<a href="#">UE-59</a>	EzSQ user parameter U (49)	0-65535	0		16-6
<a href="#">UE-60</a>	EzSQ user parameter U (50)	0-65535	0		16-6
<a href="#">UE-61</a>	EzSQ user parameter U (51)	0-65535	0		16-6
<a href="#">UE-62</a>	EzSQ user parameter U (52)	0-65535	0		16-6
<a href="#">UE-63</a>	EzSQ user parameter U (53)	0-65535	0		16-6
<a href="#">UE-64</a>	EzSQ user parameter U (54)	0-65535	0		16-6
<a href="#">UE-65</a>	EzSQ user parameter U (55)	0-65535	0		16-6
<a href="#">UE-66</a>	EzSQ user parameter U (56)	0-65535	0		16-6
<a href="#">UE-67</a>	EzSQ user parameter U (57)	0-65535	0		16-6
<a href="#">UE-68</a>	EzSQ user parameter U (58)	0-65535	0		16-6
<a href="#">UE-69</a>	EzSQ user parameter U (59)	0-65535	0		16-6
<a href="#">UE-70</a>	EzSQ user parameter U (60)	0-65535	0		16-6
<a href="#">UE-71</a>	EzSQ user parameter U (61)	0-65535	0		16-6
<a href="#">UE-72</a>	EzSQ user parameter U (62)	0-65535	0		16-6
<a href="#">UE-73</a>	EzSQ user parameter U (63)	0-65535	0		16-6

Code	Name	Data range	Initial value	Note	Page
<a href="#">UF-02</a>	EzSQ user parameter UL (00)	-2147483647~2147483647	0		16-6
<a href="#">UF-04</a>	EzSQ user parameter UL (01)	-2147483647~2147483647	0		16-6
<a href="#">UF-06</a>	EzSQ user parameter UL (02)	-2147483647~2147483647	0		16-6
<a href="#">UF-08</a>	EzSQ user parameter UL (03)	-2147483647~2147483647	0		16-6
<a href="#">UF-10</a>	EzSQ user parameter UL (04)	-2147483647~2147483647	0		16-6
<a href="#">UF-12</a>	EzSQ user parameter UL (05)	-2147483647~2147483647	0		16-6
<a href="#">UF-14</a>	EzSQ user parameter UL (06)	-2147483647~2147483647	0		16-6
<a href="#">UF-16</a>	EzSQ user parameter UL (07)	-2147483647~2147483647	0		16-6
<a href="#">UF-18</a>	EzSQ user parameter UL (08)	-2147483647~2147483647	0		16-6
<a href="#">UF-20</a>	EzSQ user parameter UL (09)	-2147483647~2147483647	0		16-6
<a href="#">UF-22</a>	EzSQ user parameter UL (10)	-2147483647~2147483647	0		16-6
<a href="#">UF-24</a>	EzSQ user parameter UL (11)	-2147483647~2147483647	0		16-6
<a href="#">UF-26</a>	EzSQ user parameter UL (12)	-2147483647~2147483647	0		16-6
<a href="#">UF-28</a>	EzSQ user parameter UL (13)	-2147483647~2147483647	0		16-6
<a href="#">UF-30</a>	EzSQ user parameter UL (14)	-2147483647~2147483647	0		16-6
<a href="#">UF-32</a>	EzSQ user parameter UL (15)	-2147483647~2147483647	0		16-6

&lt;Unit options&gt;

No.	Unit
00	non
01	%
02	A
03	Hz
04	V
05	kW
06	W
07	hr
08	s
09	kHz
10	ohm
11	mA
12	ms
13	P
14	kgm <sup>2</sup>
15	pls
16	mH
17	Vdc
18	°C
19	kWh
20	mF
21	mVs/rad
22	Nm
23	min <sup>-1</sup>
24	m/s
25	m/min
26	m/h
27	ft/s
28	ft/min
29	ft/h
30	m

No.	Unit
31	cm
32	°F
33	l/s
34	l/min
35	l/h
36	m <sup>3</sup> /s
37	m <sup>3</sup> /min
38	m <sup>3</sup> /h
39	kg/s
40	kg/min
41	kg/h
42	t/min
43	t/h
44	gal/s
45	gal/min
46	gal/h
47	ft <sup>3</sup> /s
48	ft <sup>3</sup> /min
49	ft <sup>3</sup> /h
50	lb/s
51	lb/min
52	lb/h
53	mbar
54	bar
55	Pa
56	kPa
57	PSI
58	mm

(Memo)

# Appendix Index

---

## Contents

A2.1 What This Chapter Explains .....	Appendix 2-1
A2.2 Index.....	Appendix 2-2
A2.3 Revision History .....	Appendix 2-6

## A2.1 What This Chapter Explains

An index is provided in this chapter.

To search a document, use single-byte alphanumeric characters, or double-byte Chinese characters, hiragana, and katakana letters.

## A2.2 Index

1~9	B(b)	D(d)
2CH..... 12-8-4	Base frequency.....	DB..... 12-14-2,12-15-2
2-step acceleration/deceleration12-8-5	BER..... 12-17-5	DC voltage monitor ..... 13-10
3WIRE .....	BOK ..... 12-17-5	Deceleration curve constant· 12-8-10
3-wire input .....	BRD ..... 12-13-8	Deceleration reaching frequency.....
	BRD load factor monitor..... 13-19	Deceleration stop at power-off
	BRK..... 12-17-5	..... 12-13-17
A(a)	Brake control ..... 12-17-5	Deceleration time..... 12-8-1
a/b (input terminal).....	Braking with external direct current	Deceleration time 2 ..... 12-8-3
a/b (output terminal).....	..... 12-15-2	Delay/retention of output signal.....
Acceleration curve constant· 12-8-10	Braking with direct current	Derating..... 20-14
Acceleration or deceleration input type	..... 12-14-2,12-15-2	Digital current monitor.....
..... 12-8-1	Braking with internal direct current	Disconnection detection (analog) .....
Acceleration or deceleration pattern	..... 12-14-2,12-15-2	
..... 12-8-9		E(e)
Acceleration reaching frequency.....	C(c)	ECOM..... 14-22
Acceleration stop..... 12-8-8	Capacitor life curve ..... 19-6	Electronic thermal.....
Acceleration time..... 12-8-1	Capacitor life advance notice .....	Electronic thermal duty ratio monitor
Acceleration time 2 ..... 12-8-3	Carrier frequency..... 12-12-1	..... 13-18
Acceleration waiting time ..... 12-17-5	CAS..... 12-11-2	EMC .....
Accumulated power monitor ... 13-14	CE standard .....	EXT ..... 12-16-3
ADD .....	CF1~CF4 .....	EzCOM ..... 14-22
Additional frequency .....	CM1 ..... 7-34	EzSQ..... 16-6
Additional frequency sign .....	Commercial switch..... 12-17-2	End amount.....
AHD .....	Communication between inverters	End ratio.....
Ai1 ..... 7-32	(EzCOM) ..... 14-22	Edge operation..... 12-15-3
Ai2 ..... 7-32	Communication error selection .. 14-5	EU directive.....
Ai3 ..... 7-32	Communication function..... 14-1	External thermistor.....
Ai1Dc.....	Communication disconnection	External error [EXT] ..... 12-16-3
Ai2Dc.....	detection signal ..... 14-5	External dimensions..... 20-6
Ai3Dc.....	Constant torque characteristics (VP)	
AL .....	..... 12-9-3	
Alarm code output .....	Constant torque electronic thermal...	
Alarm relay output terminal.....	Control circuit terminal..... 7-25	
Alarm relay output a/b selection .....	Control gain switch ..... 12-11-2	
Allowable instantaneous power failure	Control mode..... 12-9-1	
time..... 12-16-9	Cooling fan operation ..... 12-18-1	
Analog input..... 7-25,7-31	Cooling fin heating prewarning level ·	
Analog disconnection .....	Cooling fin temperature monitor13-13	
Analog input filter .....	Copy..... 9-18,9-19	
Ao1 ..... 7-32	Cumulative RUN time .....	
Ao2 ..... 7-32	CS..... 12-17-2	
Automatic carrier frequency reduction		
..... 12-12-2		
Automatic energy-saving..... 12-9-7		
Automatic torque boost..... 12-9-9		
ATR..... 12-11-13		
Auxiliary excitation..... 12-14-13		
AVR.....		

F(f)	G(g)	L(l)
FA1~FA5.....	Gain switch (CAS) ..... 12-11-2	L ..... 7-32
Factory default setting.....	Gain switch (PID) ..... 12-10-14	LAC ..... 12-8-11
FBV..... 12-10-29		LAD.....
FDN.....		LD/LD rating.....
Feedback ..... 12-9-35	H(h)	Level mode ..... 12-15-3
FM ..... 7-34	H..... 7-32	Life alarm output..... 19-6
FOC ..... 12-14-13	High duty ..... 13-22	Life diagnostic monitor..... 13-16
Forced operation.....	High torque multi-operation· 12-11-10	LOC.....
Forcing..... 12-14-13		LOG1~LOG6.....
F/R.....		Logical output signal.....
Free electronic thermal.....	I(i)	Low current signal.....
Free-run stop..... 12-15-1	Initialization.....	Low duty..... 13-22
Free v/f ..... 12-9-5	Initialization home screen..... 9-20	Lower limiter.....
Frequency calculation.....	Input phase loss..... 12-16-1	
Frequency addition.....	Input terminal response time.....	M(m)
Frequency command selection (main speed).....	Input terminal.....	Main circuit terminal..... 7-6
Frequency jump..... 12-16-10	Input terminal a/b.....	Main circuit wiring..... 7-13
Frequency reached signal.....	Input power monitor ..... 13-14	Maintenance and inspection..... 19-1
Frequency pull-in restart ..... 12-14-6	Inspection ..... 8-1,19-1	Manual torque boost ..... 12-9-8
Frequency conversion coefficient13-4	Instantaneous power failure non-stop..... 12-13-19	Maximum frequency.....
Frequency conversion monitor .. 13-4	Instantaneous power failure/undervoltage retry.....12-13-9	Megger test..... 19-4
Frequency limiter.....	Instantaneous power failure/undervoltage tripping selection during stop.....12-16-6	MI1~MI11 ..... 16-6
FRS..... 12-15-1	Intelligent input terminal ..... To Input terminal	MJA.....
F-OP.....	Intelligent output terminal .. To Output terminal	ModBus-RTU mode ..... 14-1
FW.....	Inverter rated current monitor .. 13-22	MO1~MO7..... 16-6
FWR.....	IP..... 12-16-6	Monitor mode..... 13-1
FUP.....	IRDY.....	Motor constant.....
		Motor's rated voltage.....
		Multistage position command12-17-27
		Multistage acceleration or deceleration..... 12-8-5
		Multistage speed.....
		Multi-step input determination time..... 12-10-9
	J(j)	
	JG.....12-17-4	N(n)
	Jogging .....12-17-4	NDc..... 14-5
		ND/ND rating.....
	K(k)	NO/NC (input terminal).....
	KHC ..... 13-14	NO/NC (output terminal).....
		Normal rotation in process signal .....



O(o)	P(p)	R(r)
OD..... 12-10-28	PCC .....	Remote operation .....
Offline auto-tuning .....	PID..... 12-10-13	Reduced torque electronic thermal ...
OHF .....	PIDC..... 12-10-13	Reduced torque characteristics (VP)
OKHC..... 13-15	PID2..... 12-10-27	..... 12-9-4
OL.....	PIDC2..... 12-10-27	Reduced voltage start..... 12-14-1
OLR..... 12-13-2	PID3..... 12-10-27	Reset .....
Online auto-tuning .....	PIDC3..... 12-10-27	Retry selection .... 12-13-9 - 12-13-15
ONT .....	PID4..... 12-10-27	Relay output terminal.....
Operation command .....	PIDC4..... 12-10-27	Retention of analog command.....
Operation command selection.....	PIO..... 12-10-22	Reverse rotation in process signal...
Operation direction limit selection ....	PRO .....	Reverse rotation prevention .....
Operation direction monitor .....	PPI .....	Reversible.....
Operation direction selection .....	P/PI switch .....	RNT.....
Operation in process signal .....	P24 .....	RS.....
Operation method..... 10-2	Phase loss protection12-16-1,12-16-2	RUN .....
Operation preparation completed	Power supply ON time elapsed.....	RUN time/power supply ON time
signal.....	Power supply ON time monitor .....	elapsed .....
Operator.....	Pressure test .....	RV.....
Operator frequency.....	Pulse counter .....	RVR.....
Operator keypad .....	Pulse counter monitor.....	
OTQ..... 12-11-9	Pulse string frequency input.....	
Output current monitor..... 13-9	Pull-in restart .....	
Output frequency setting..... 13-3	Prevention of power restoration	
Output frequency monitor..... 13-2	restarting .....	
Output monitor..... 13-1	Program counter .....	
Output off-delay time.....	Program number monitor .....	
Output on-delay time.....	Programmable controller .....	
Output phase loss detection · 12-16-2	Protective function .....	
Output power monitor..... 13-15		
Output signal logical calculation .....		
Output terminal .....		
Output terminal a/b selection .....		
Output voltage gain .....		
Output voltage monitor .....		
Output torque monitor .....		
Overcurrent suppression..... 12-13-3		
Overload limit .....		
Overload advance notice .....		
Overtorque..... 12-11-9		
Overvoltage suppression		
..... 12-13-4,12-13-5		

S(s)	T(t)	U(u)
SCHG .....	TBS .....	UDC .....
Second control..... 12-17-1	Thermal warning level (inverter).....	UL standard.....
Secondary resistance correction	Thermal warning level (motor).....	Undertorque .....
..... 12-9-12	Thermistor .....	Undervoltage retry .....
Sensorless vector control..... 12-9-12	THM .....	UP/DOWN .....
SET..... 12-17-1	Torque bias .....	Upper limiter.....
Severe failure signal .....	Torque bias monitor .....	USP..... 12-16-4
SFT .....	Torque boost .....	UV..... 12-16-7
SF1 ~ SF7.....	Torque command..... 12-11-14	
Signal of reduced rotation speed of the	Torque command monitor... 12-11-15	V(v)
cooling fan .....	Torque control..... 12-11-14	VC..... 12-9-3
Simplified sequence (EzSQ) .....	Torque LADSTOP..... 12-11-8	VLD/VLD rating .....
..... 16-6	Torque limit .....	VP1.7-squared..... 12-9-4
Sink logic..... 7-25	Torque monitor..... 12-11-15	
Slide switch SW .....	Trial (Test) run .....	W(w)
..... 7-25	TRQ .....	WAC .....
SLV .....	TRQ1..... 12-11-8	WAF .....
..... 12-9-12	TRQ2..... 12-11-8	Warning function..... 18-31
Soft-lock..... 9-24	Troubleshooting .....	Warning monitor..... 18-28
Source logic..... 7-25	Trip count monitor..... 18-3	WCAi1.....
Specification table .....	Trip monitor..... 18-3	WCAi2.....
..... 20-1	Trip monitor display..... 9-16,18-3	WCAi3.....
Speed control .....	Trip retry..... 12-13-9 - 12-13-16	Window comparator .....
..... 12-9-1		Wiring of control circuit terminal · 7-28
Speed response		
..... 12-9-12,12-9-14,12-9-16		Z(z)
STA .....		Zero-Hz signal .....
Stability constant..... 12-9-11		Zero-Hz range sensorless vector
STP.....		control..... 12-9-14
Stop mode selection .....		ZS .....
..... 12-15-1		
Stop/reset key selection.....		
Start/end of external frequency .....		
Start amount .....		
Start ratio.....		
Start-up frequency..... 12-14-1		
Start-up contact signal.....		
Synchronous operation..... 12-9-20		

### A2.3 Revision History

\* Typographical errors may be corrected without prior notice.

#### Revision History

No.	Revision details	Date
NT251	Initial edition	2016/7
NT251A	Addition of specifications due to expansion of product capacity, correction of errors	2016/11
NT251B	Addition and correction of functions for Ver2.00. -> See changes in 21.3 P1 Ver.2.00	2016/12
NT251B-1	Correction of errors (incorrect parameter number, etc.)	2017/3
NT251B-2	Correction of errors (correction of errors in instructions of operator pad, correction of analog hold explanatory drawing), addition of specifications due to expansion of product capacity	2017/5